

Fixed Voltage Enhanced Single Port Series - MS-012

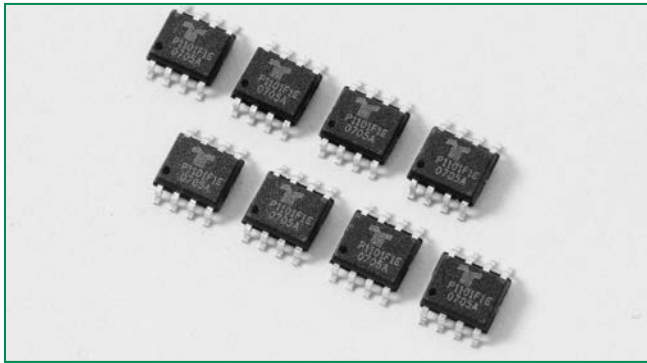

Description

The MS-012 packaged Fixed Voltage Enhanced Single Port Series consists of SIDACtor® components designed to protect sensitive SLICs (Subscriber Line Interface Circuit) from damaging overvoltage transients.

The series provides single port protection using a fixed voltage switching device for negative surges. Positive surges are routed through enhanced switching diodes to a ground reference. The series is also pin-to-pin compatible to industry standard programmable SO-8 SLIC protectors.

Agency Approvals

Agency	Agency File Number
	E133083

Pinout

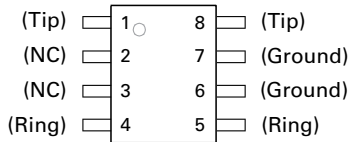

Schematic Symbol

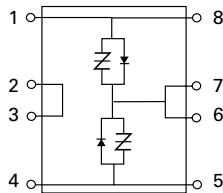

Features & Benefits

- Integrated fast switching diodes for positive voltage surges
- RoHS Compliant and Lead-Free
- Single port protection in one package
- Low voltage overshoot
- Low on-state voltage
- Pin-to-pin SO-8 compatible footprint
- Fails short circuit when surged in excess of ratings
- Does not degrade surge capability after multiple surge events within limit
- Pb-free E3 means 2nd level interconnect is Pb-free and the terminal finish material is tin(Sn) (IPC/JEDEC J-STD-609A.01)

Applicable Global Standards

- TIA-968-A
 - TIA-968-B
 - ITU K.20/21 Enhanced Level
 - ITU K.20/21 Basic Level
 - GR 1089 Inter-building*
 - GR 1089 Intra-building*
 - IEC 61000-4-5 2nd edition
 - YD/T 1082
 - YD/T 993
 - YD/T 950
- * Series resistance required

Electrical Characteristics

Part Number	Marking	$V_{DRM}@I_{DRM}=5\mu A$	$V_S@100V/\mu s$	I_H	I_S	$I_T@V_T$	$V_T@I_T=1$ Amps	$V_F@25^\circ$	Capacitance
		V min	V max	mA min	mA max	A max	V max	V max	
P0641DF-1E	P0641F1E	58	77	150	800	1	5	5	See Capacitance Values Table
P0721DF-1E	P0721F1E	65	88	150	800	1	5	5	
P0901DF-1E	P0901F1E	75	98	150	800	1	5	5	
P0991DF-1E	P0991F1E	80	104	150	800	1	5	5	
P1001DF-1E	P1001F1E	85	110	150	800	1	5	5	
P1101DF-1E	P1101F1E	95	130	150	800	1	5	5	
P1301DF-1E	P1301F1E	120	165	150	800	1	5	5	
P1501DF-1E	P1501F1E	140	180	150	800	1	5	5	
P1701DF-1E	P1701F1E	160	200	150	800	1	5	5	

Notes:
 - Absolute maximum ratings measured at $T_A=25^\circ C$ (unless otherwise noted).
 - Components are not appropriate for positive ringing systems
 - All electrical characteristics shown are defined from Tip (pins 1 & 8) to Ground (pins 6 & 7), and Ring (pins 4 & 5) to ground (pins 6 & 7)
 - $V_F < 8.5$ volts @ 10 / 700 μs , 375 Amps

Capacitance Values

Part Number	pF Pin 1,8-6,7 / 4,5-6,7 Tip-Ground, Ring-Ground		pF Pin 1,8-4,5 Tip-Ring	
	MIN	MAX	MIN	MAX
P0641DF-1E	40	90	20	45
P0721DF-1E	35	85	20	45
P0901DF-1E	30	80	20	40
P0991DF-1E	25	75	15	35
P1001DF-1E	25	75	15	35
P1101DF-1E	25	70	15	30
P1301DF-1E	20	70	15	30
P1701DF-1E	20	70	15	30

Note: Off-state capacitance (C_o) is measured at 1 MHz with a 2V bias

Surge Ratings

Series	I_{PP}				I_{TSM}	di/dt
	2/10	1.2/50 - 8/20	10/700 - 5/310	10/1000	600V _{RMS} 1s	
	A min	A min	A min	A min	A min	Amps/ μ s max
F	120	100	50	30	1	500

Notes:

- Peak pulse current rating (I_{pp}) is repetitive and guaranteed for the life of the product that is in thermal equilibrium.
- I_{pp} ratings applicable over temperature range of -40°C to +85°C
- The component must initially be in thermal equilibrium with -40°C $\leq T_J \leq$ +150°C

Thermal Considerations

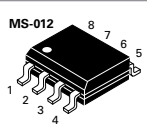
Package	Symbol	Parameter	Value	Unit
	T_J	Operating Junction Temperature Range	-40 to +150	°C
	T_S	Storage Temperature Range	-65 to +150	°C
	$R_{\theta JA}$	Thermal Resistance: Junction to Ambient	120	°C/W

V-I Characteristics

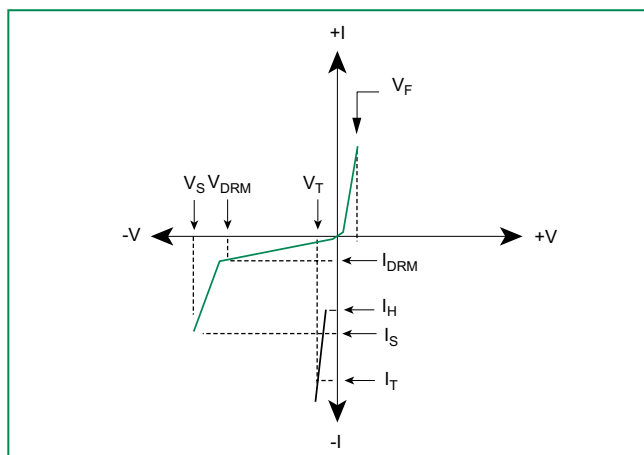

$t_r \times t_d$ Pulse Waveform

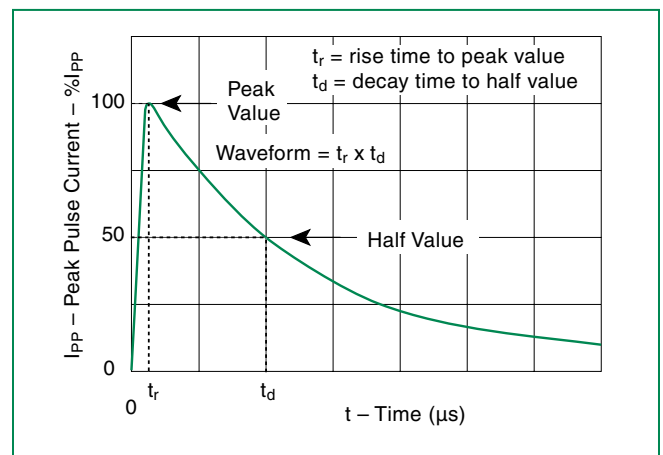

Normalized V_s Change vs. Junction Temperature

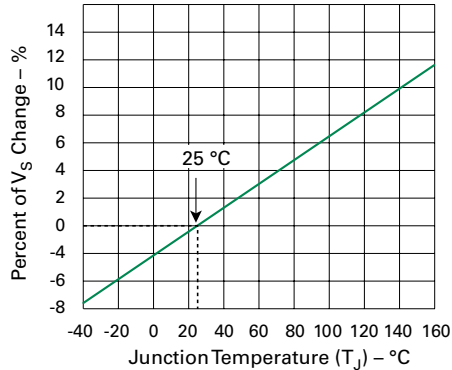

Normalized DC Holding Current vs. Case Temperature

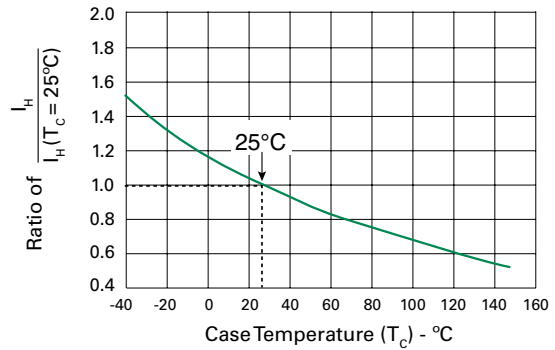

Soldering Parameters

Reflow Condition	Pb-Free assembly (see Fig. 1)	
Pre Heat	-Temperature Min ($T_{s(min)}$)	+150°C
	-Temperature Max ($T_{s(max)}$)	+200°C
	-Time (Min to Max) (t_s)	60-180 secs.
Average ramp up rate (Liquidus Temp (T_L) to peak)	3°C/sec. Max.	
$T_{s(max)}$ to T_L - Ramp-up Rate	3°C/sec. Max.	
Reflow	-Temperature (T_L) (Liquidus)	+217°C
	-Temperature (t_L)	60-150 secs.
Peak Temp (T_p)	+260(+0/-5)°C	
Time within 5°C of actual PeakTemp (t_p)	30 secs. Max.	
Ramp-down Rate	6°C/sec. Max.	
Time 25°C to Peak Temp (T_p)	8 min. Max.	
Do not exceed	+260°C	

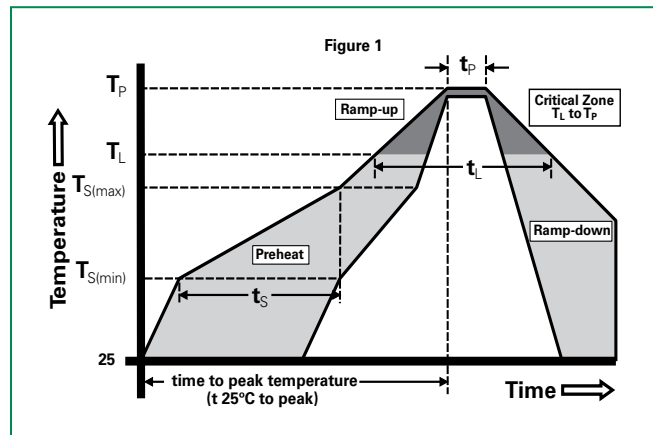

Physical Specifications

Lead Material	Copper Alloy
Terminal Finish	100% Matte-Tin Plated
Body Material	UL Recognized compound meeting flammability rating V-0

Additional Information



Datasheet



Resources



Samples

Environmental Specifications

High Temp Voltage Blocking	80% Rated V_{DRM} (V_{DC}) +125°C or +150°C, 504 or 1008 hrs. MIL-STD-750 (Method 1040) JEDEC, JESD22-A-101
Temp Cycling	-65°C to +150°C, 15 min. dwell, 10 up to 100 cycles. MIL-STD-750 (Method 1051) EIA/JEDEC, JESD22-A104
Biased Temp & Humidity	52 V_{DC} (+85°C) 85%RH, 504 up to 1008 hrs. EIA/JEDEC, JESD22-A-101
High Temp Storage	+150°C 1008 hrs. MIL-STD-750 (Method 1031) JEDEC, JESD22-A-101
Low Temp Storage	-65°C, 1008 hrs.
Thermal Shock	0°C to +100°C, 5 min. dwell, 10 sec. transfer, 10 cycles. MIL-STD-750 (Method 1056) JEDEC, JESD22-A-106
Autoclave (Pressure Cooker Test)	+121°C, 100%RH, 2atm, 24 up to 168 hrs. EIA/JEDEC, JESD22-A-102
Resistance to Solder Heat	+260°C, 30 secs. MIL-STD-750 (Method 2031)
Moisture Sensitivity Level	85%RH, +85°C, 168 hrs., 3 reflow cycles (+260°C Peak). JEDEC-J-STD-020, Level 1

Dimensions — MS-012

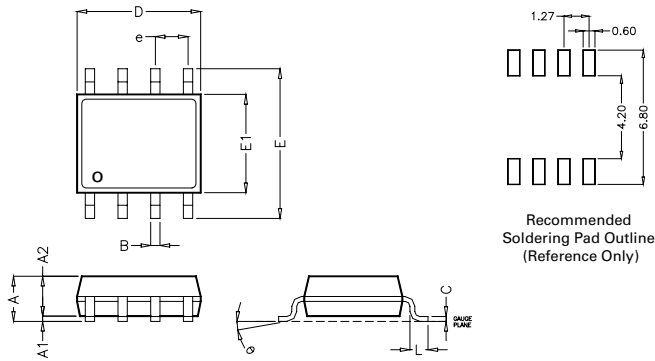

Dimension	Inches		Millimeters	
	MIN	MAX	MIN	MAX
A	0.053	0.069	1.35	1.75
A1	0.004	0.010	0.10	0.25
A2	0.043	0.065	1.25	1.65
B	0.012	0.020	0.31	0.51
C	0.007	0.010	0.17	0.25
D	0.189	0.197	4.80	5.00
E	0.228	0.244	5.80	6.20
E1	0.150	0.157	3.80	4.00
e	0.050 BSC*		1.27 BSC*	
L	0.016	0.050	0.40	1.27

* BSC = Basic Spacing between Centers

Part Numbering

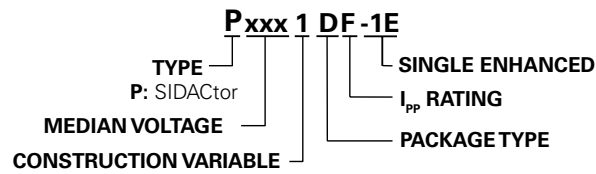

Part Marking

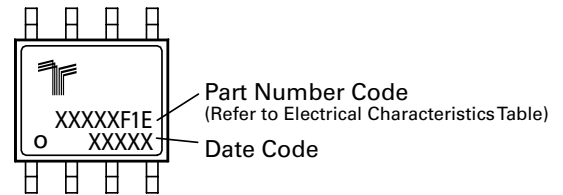

Packing Options

Package Type	Description	Quantity	Added Suffix	Industry Standard
D	MS-012 SMT 8-pin SOIC Tape and Reel Pack	2500	N/A	EIA-481-D

Tape and Reel Specifications — MS-012

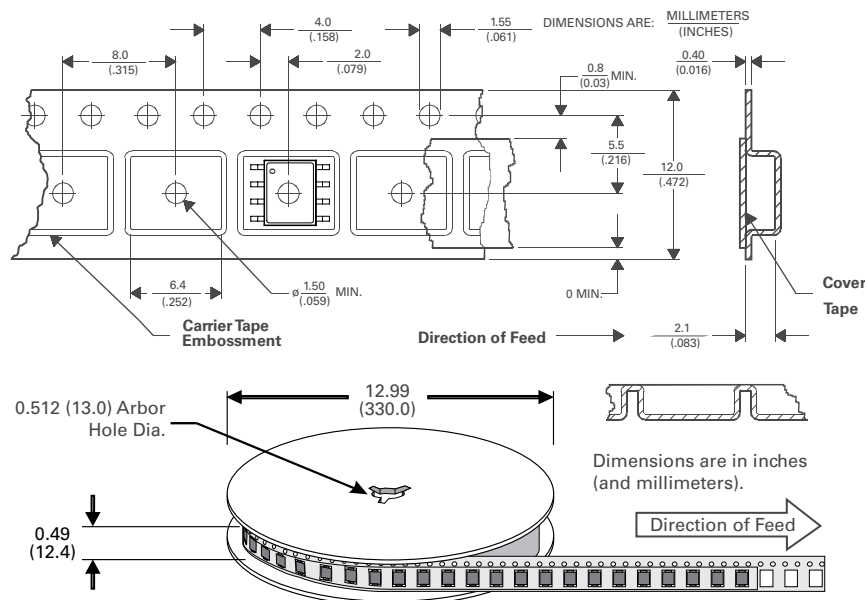

Disclaimer Notice - Information furnished is believed to be accurate and reliable. However, users should independently evaluate the suitability of and test each product selected for their own applications. Littelfuse products are not designed for, and may not be used in, all applications. Read complete Disclaimer Notice at www.littelfuse.com/disclaimer-electronics.