

## FLARE-B

29 x 23 mm lens with ~100° x 10° oval beam.  
Assembly with installation tape.

### TECHNICAL SPECIFICATIONS:

Dimensions	29.0 x 22.8 mm
Height	12.8 mm
Fastening	tape, screw
ROHS compliant	yes ⓘ



### MATERIAL SPECIFICATIONS:

Component	Type	Material	Colour	Finish
FLARE-B	Single lens	PMMA	clear	
FLARE-B-TAPE	Tape	Acrylic foam	black	

### ORDERING INFORMATION:

Component		Qty in box	MOQ	MPQ	Box weight (kg)
CA10932_FLARE-B	Single lens	2448	288	144	9.8
» Box size: 476 x 273 x 292 mm					

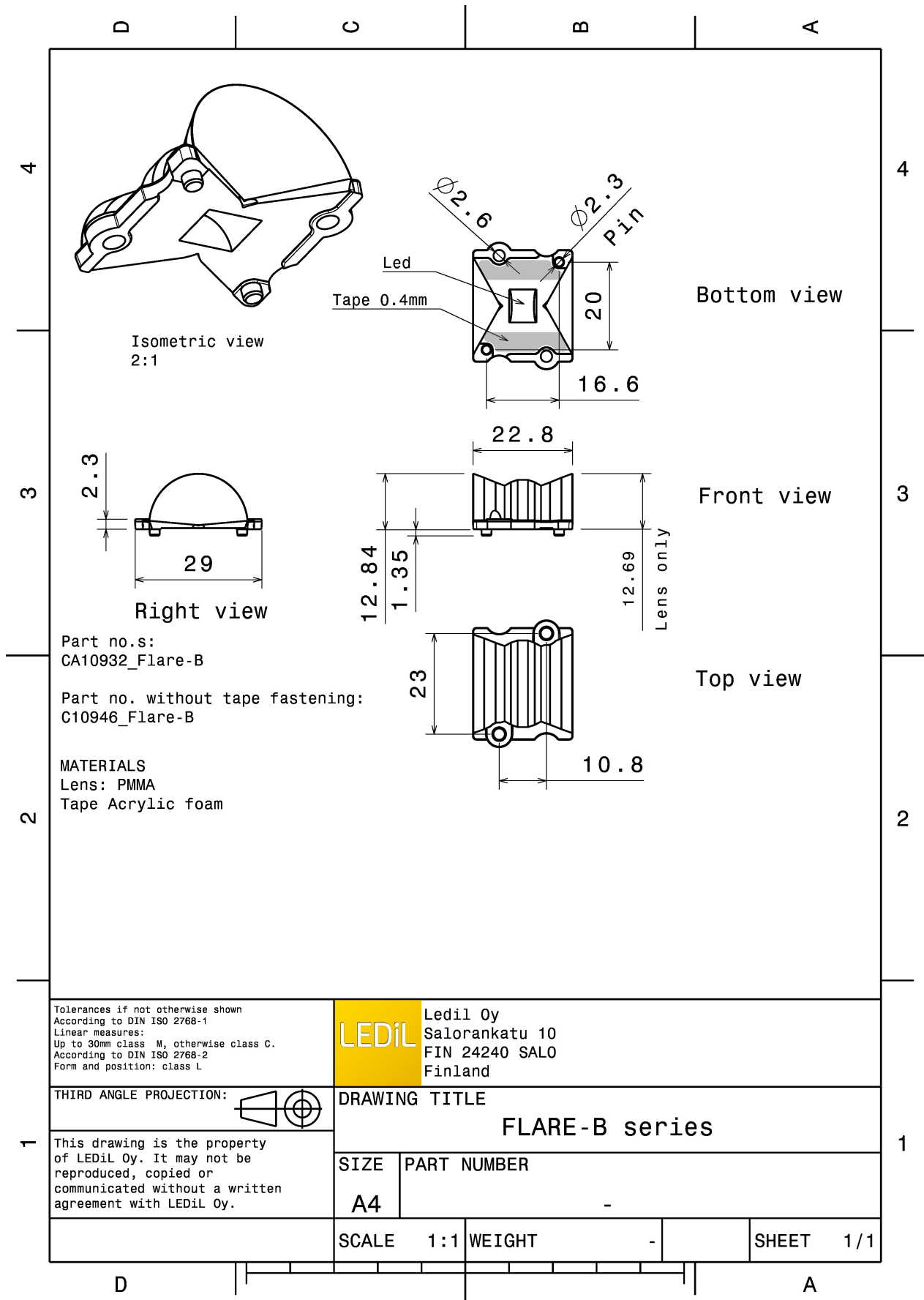

See also our general installation guide: [www.ledil.com/installation\\_guide](http://www.ledil.com/installation_guide)

### PHOTOMETRIC DATA (MEASURED):

#### CREE

LED XB-D  
 FWHM / FWTM 10.0 + 108.0° / 30.0 + 167.0°  
 Efficiency 93 %  
 Peak intensity 1.5 cd/lm  
 LEDs/each optic 1  
 Light colour White  
 Required components:

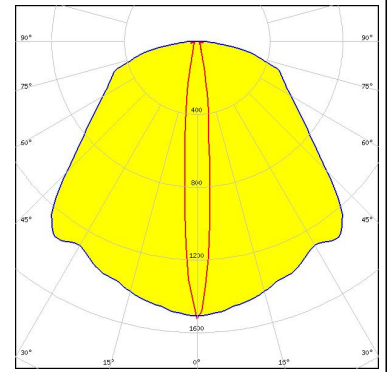

#### CREE

LED XP-E  
 FWHM / FWTM 102.0 + 10.0° / 154.0 + 26.0°  
 Efficiency 93 %  
 Peak intensity 1.8 cd/lm  
 LEDs/each optic 1  
 Light colour White  
 Required components:

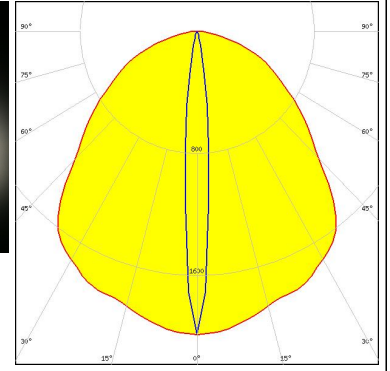
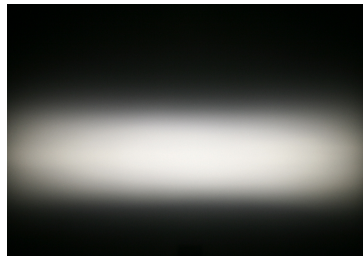

#### CREE

LED XP-E2  
 FWHM / FWTM 11.0 + 101.0° / 22.0 + 150.0°  
 Efficiency 94 %  
 Peak intensity 2.3 cd/lm  
 LEDs/each optic 1  
 Light colour White  
 Required components:

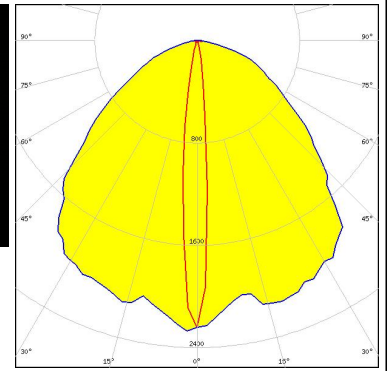
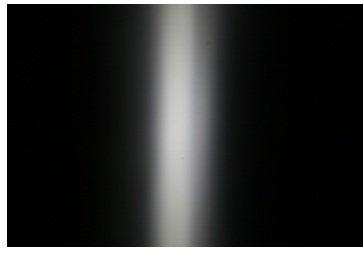

#### CREE

LED XP-G  
 FWHM / FWTM 118.0 + 15.0° / 160.0 + 30.0°  
 Efficiency 93 %  
 Peak intensity 1 cd/lm  
 LEDs/each optic 1  
 Light colour White  
 Required components:

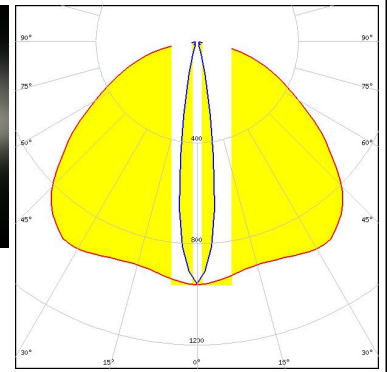
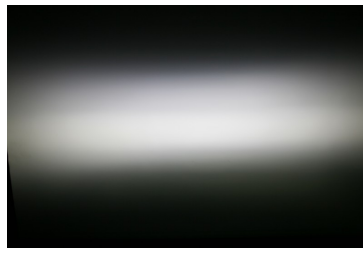

### PHOTOMETRIC DATA (MEASURED):

#### LUMILEDS

LED LUXEON Rebel  
 FWHM / FWTM 101.0 + 14.0° / 142.0 + 29.0°  
 Efficiency 93 %  
 Peak intensity 1.7 cd/lm  
 LEDs/each optic 1  
 Light colour White  
 Required components:

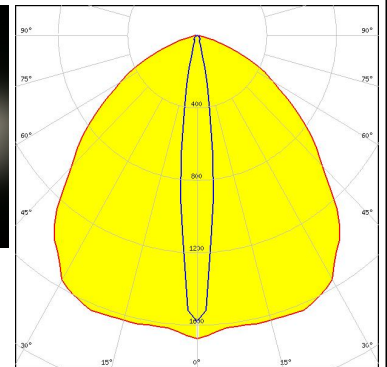
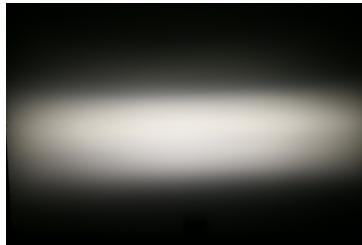

#### LUMILEDS

LED LUXEON Rebel ES  
 FWHM / FWTM 12.0 + 104.0° / 35.0 + 154.0°  
 Efficiency 94 %  
 Peak intensity 1.4 cd/lm  
 LEDs/each optic 1  
 Light colour White  
 Required components:

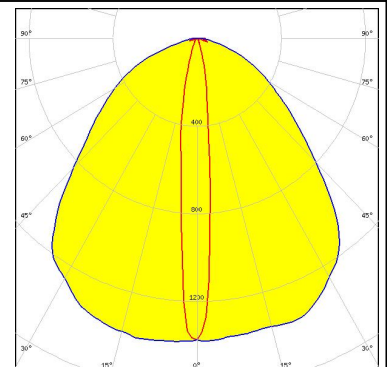

#### LUMILEDS

LED LUXEON T  
 FWHM / FWTM 13.0 + 105.0° / 29.0 + 152.0°  
 Efficiency 93 %  
 Peak intensity 1.5 cd/lm  
 LEDs/each optic 1  
 Light colour White  
 Required components:

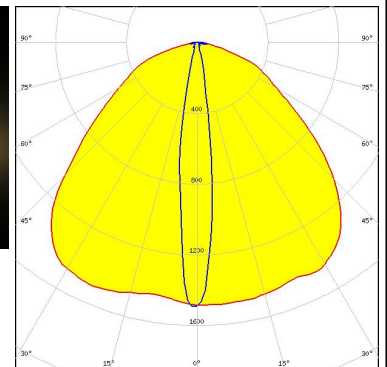
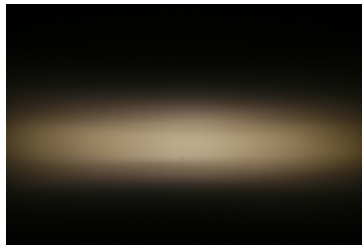

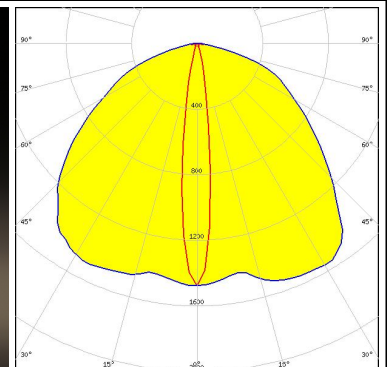
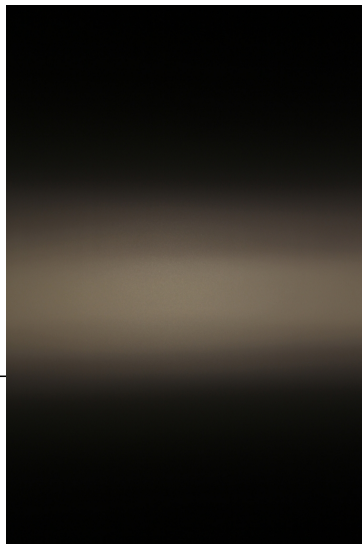

#### LUMILEDS

LED LUXEON TX  
 FWHM / FWTM 14.0 + 114.0° / 29.0 + 156.0°  
 Efficiency 93 %  
 Peak intensity 1.6 cd/lm  
 LEDs/each optic 1  
 Light colour White  
 Required components:

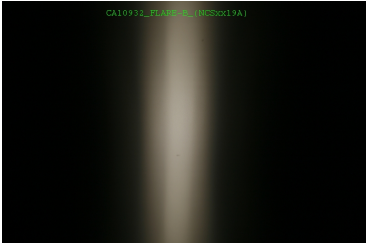

### PHOTOMETRIC DATA (MEASURED):

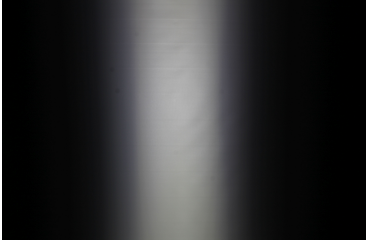
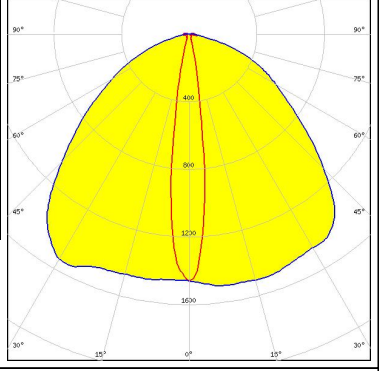
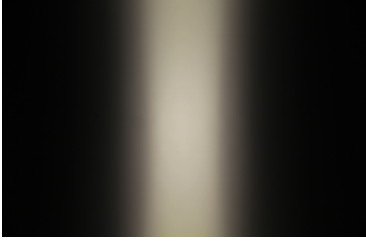
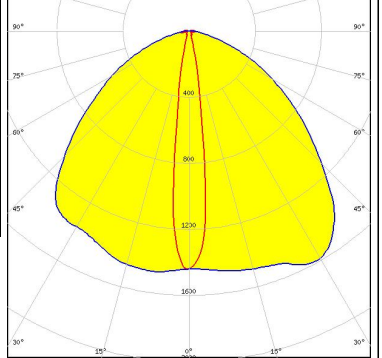
<p><b>NICHIA</b></p> <p>LED NCSxx19A            FWHM / FWTM 9.0 + 88.0° / 26.0 + 154.0°            Efficiency 94 %            Peak intensity 2 cd/lm            LEDs/each optic 1            Light colour White            Required components:</p>		
<p><b>NICHIA</b></p> <p>LED NCSxx19B            FWHM / FWTM 11.0 + 103.0° / 28.0 + 160.0°            Efficiency 94 %            Peak intensity 1.9 cd/lm            LEDs/each optic 1            Light colour White            Required components:</p>		
<p><b>NICHIA</b></p> <p>LED NVSW219F            FWHM / FWTM 15.0 + 108.0° / 28.0 + 150.0°            Efficiency 94 %            Peak intensity 1.5 cd/lm            LEDs/each optic 1            Light colour White            Required components:</p>		
<p><b>NICHIA</b></p> <p>LED NVSxx19B/NVSxx19C            FWHM / FWTM 14.0 + 110.0° / 27.0 + 151.0°            Efficiency 94 %            Peak intensity 1.6 cd/lm            LEDs/each optic 1            Light colour White            Required components:</p>		

### PHOTOMETRIC DATA (MEASURED):

#### OSRAM Opto Semiconductors

LED OSLON Square EC  
 FWHM / FWTM 13.0 + 104.0° / 26.0 + 157.0°  
 Efficiency 94 %  
 Peak intensity 1.7 cd/lm  
 LEDs/each optic 1  
 Light colour White  
 Required components:

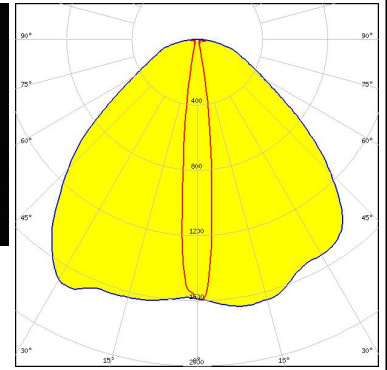
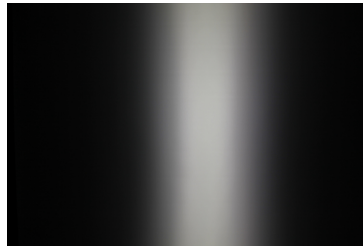

#### OSRAM Opto Semiconductors

LED OSLON Square EC  
 FWHM / FWTM 12.0 + 104.0° / 33.0 + 162.0°  
 Efficiency %  
 LEDs/each optic 1  
 Light colour White  
 Required components:

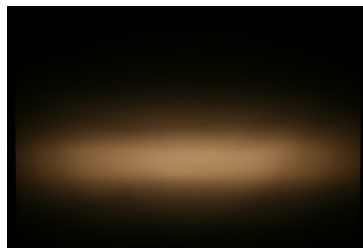

#### OSRAM Opto Semiconductors

LED OSLON SSL 150  
 FWHM / FWTM 9.0 + 117.0°  
 Efficiency 93 %  
 Peak intensity 1.6 cd/lm  
 LEDs/each optic 1  
 Light colour White  
 Required components:

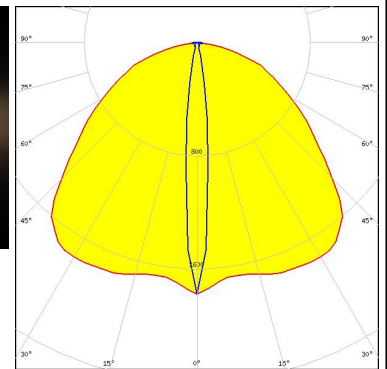
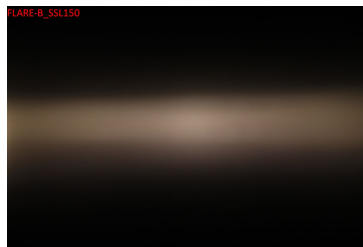



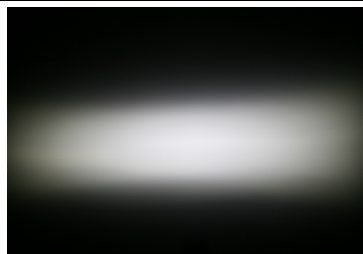

#### OSRAM Opto Semiconductors

LED OSLON SSL 80  
 FWHM / FWTM 83.0 + 11.0° / 144.0 + 24.0°  
 Efficiency 93 %  
 Peak intensity 2.2 cd/lm  
 LEDs/each optic 1  
 Light colour White  
 Required components:

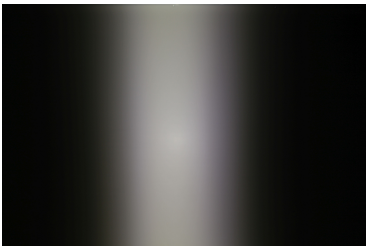
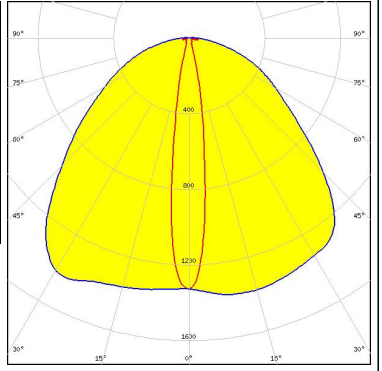

**PHOTOMETRIC DATA (MEASURED):**

<p> SEOUL SEMICONDUCTOR</p> <p>LED Z5 FWHM / FWTM 12.0 + 96.0° Efficiency % LEDs/each optic 1 Light colour White Required components:</p>	
<p> SEOUL SEMICONDUCTOR</p> <p>LED Z5M3 FWHM / FWTM 15.0 + 108.0° / 30.0 + 161.0° Efficiency 94 % Peak intensity 1.4 cd/lm LEDs/each optic 1 Light colour White Required components:</p>	 
<p><b>SHARP</b></p> <p>LED Double Dome (GM2BB) FWHM / FWTM 104.0 + 10.0° Efficiency % LEDs/each optic 1 Light colour White Required components:</p>	

### PHOTOMETRIC DATA (SIMULATED):



LED XP-G2  
 FWHM / FWTM 11.0 + 83.0° / 21.0 + 146.0°  
 Efficiency 94 %  
 Peak intensity 2.4 cd/lm  
 LEDs/each optic 1  
 Light colour White  
 Required components:

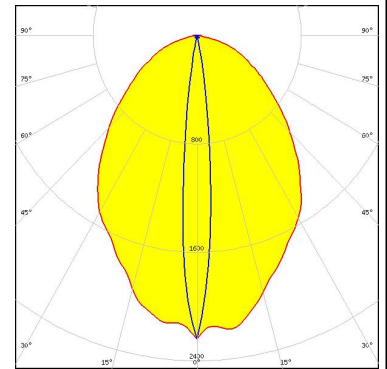

LED LUXEON CZ  
 FWHM / FWTM 6.0 + 54.0° / 15.0 + 134.0°  
 Efficiency 97 %  
 Peak intensity 3.9 cd/lm  
 LEDs/each optic 1  
 Light colour Red  
 Required components:

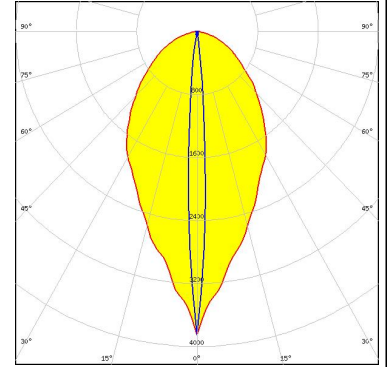

LED LUXEON H50-2  
 FWHM / FWTM 13.0 + 90.0° / 22.0 + 140.0°  
 Efficiency 94 %  
 Peak intensity 2.1 cd/lm  
 LEDs/each optic 1  
 Light colour White  
 Required components:

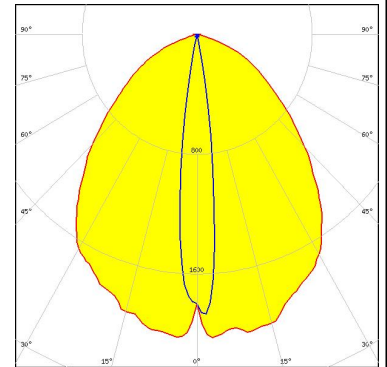

LED LUXEON Rubix  
 FWHM / FWTM 6.0 + 52.0° / 14.0 + 134.0°  
 Efficiency 97 %  
 Peak intensity 4 cd/lm  
 LEDs/each optic 1  
 Light colour Red  
 Required components:

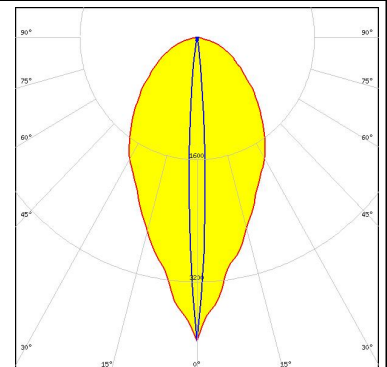



### PHOTOMETRIC DATA (SIMULATED):

<p><b>LUMILEDS</b></p> <p>LED LUXEON Z ES</p> <p>FWHM / FWTM 8.0 + 84.0° / 16.0 + 142.0°</p> <p>Efficiency 97 %</p> <p>Peak intensity 2.8 cd/lm</p> <p>LEDs/each optic 1</p> <p>Light colour White</p> <p>Required components:</p>	
<p><b>OSRAM</b> Opto Semiconductors</p> <p>LED OSCONIQ P 3737 (3W version)</p> <p>FWHM / FWTM 94.0 + 16.0° / 150.0 + 28.0°</p> <p>Efficiency 97 %</p> <p>Peak intensity 1.6 cd/lm</p> <p>LEDs/each optic 1</p> <p>Light colour White</p> <p>Required components:</p>	
<p><b>OSRAM</b> Opto Semiconductors</p> <p>LED OSOLON Signal</p> <p>FWHM / FWTM 8.0 + 80.0° / 14.0 + 148.0°</p> <p>Efficiency 97 %</p> <p>Peak intensity 3 cd/lm</p> <p>LEDs/each optic 1</p> <p>Light colour White</p> <p>Required components:</p>	
<p><b>OSRAM</b> Opto Semiconductors</p> <p>LED OSOLON Signal</p> <p>FWHM / FWTM 8.0 + 81.0° / 15.0 + 148.0°</p> <p>Efficiency 97 %</p> <p>Peak intensity 2.9 cd/lm</p> <p>LEDs/each optic 1</p> <p>Light colour White</p> <p>Required components:</p>	

### PHOTOMETRIC DATA (SIMULATED):

**OSRAM**  
Opto Semiconductors

LED	OSLON Signal
FWHM / FWTM	8.0 + 79.0° / 16.0 + 148.0°
Efficiency	97 %
Peak intensity	3 cd/lm
LEDs/each optic	1
Light colour	White
Required components:	

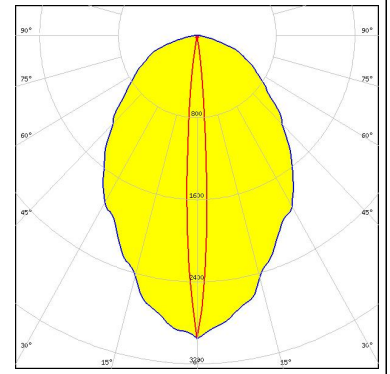

### GENERAL INFORMATION:

NOTE: The typical beam angle will be changed by different color, chip size and chip position tolerance. The typical total beam angle is the full angle measured where the luminous intensity is half of the peak value.

### MATERIALS:

As part of our continuous research and improvement processes, and to ensure the best possible quality and availability of our products, LEDiL reserves the right to change material grades without notice.

### PRODUCT DATA USER AGREEMENT AND DISCLAIMER:

The measured data in the provided downloadable LEDiL Product Datasheets and Mechanical 2D-Drawings is rounded and provided as reference for planning. LEDiL Oy's optical specifications have been verified by conducting performance testing of the products in accordance with the company's quality system. The reported data are averaged results of multiple measurements with typical variation. LEDiL Oy reserves the right to without prior notification make changes and improvements to its products.

LEDiL Oy assumes neither warranty, nor guarantee nor any other liability of any kind for the contents and correctness of the provided data. The provided data has been generated with highest diligence but the provided data may in reality not represent the complete possible variation range of all intrinsic parameters. Therefore, in certain cases a deviation from the provided data could occur.

LEDiL Oy reserves the right to undertake technical changes of its products without further notification which could lead to changes in the provided data. LEDiL Oy assumes no liability of any kind for the possible deviation from any provided data or any other damage resulting from the usage of the provided data.

The user agrees to this disclaimer and user agreement with the download or usage of the provided files.

#### LEDiL Oy

Joensuunkatu 13  
FI-24240 SALO  
Finland

#### LEDiL Inc.

228 West Page Street  
Suite D  
Sycamore IL 60178  
USA

#### Ledil Optics Technology (Shenzhen) Co., Ltd.

# 405 , Block B  
Casic Motor Building  
Shenzhen 518057  
P.R.CHINA

#### Local sales and technical support

[www.ledil.com/  
where\\_to\\_buy](http://www.ledil.com/where_to_buy)

#### Shipping locations

Salo, Finland  
Hong Kong, China

#### Distribution Partners

[www.ledil.com/  
where\\_to\\_buy](http://www.ledil.com/where_to_buy)