

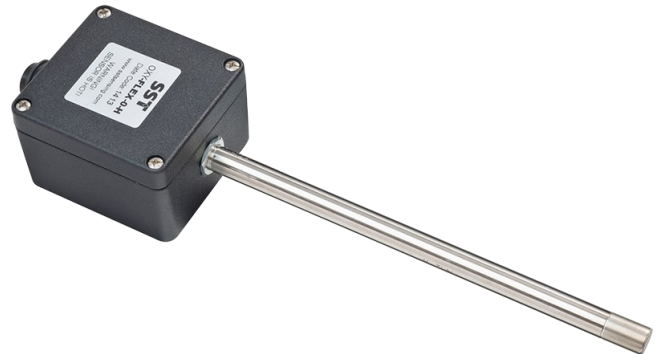









DATA SHEET

Zirconia O₂ Sensors OXY-Flex Oxygen Analyser

FEATURES

- High accuracy linear output
- Externally triggered automatic or manual calibration
- Can be calibrated in fresh air (20.7% O₂) or to any other known O₂ concentration
- Selectable output filtering allows adaptive, fast and dynamic or slow and stable output



Housing  COMPACT  ROBUST	Supply Voltage  24 V VOLTAGE	Gas Temp  -100°C to +250°C TEMPERATURE  -100°C to +400°C TEMPERATURE	Digital Output  RS232	Analogue Output  0 - 10 V VOLTAGE  4-20mA CURRENT	Response Time  < 15 secs
--	--	--	--	---	---

BENEFITS

- Cycling 3.3V_{DC} logic output allows direct monitoring of the O₂ sensor pump cycle for diagnostic purposes
- No reference gas required

TECHNICAL SPECIFICATIONS

Supply voltage	24V _{DC} ± 10%
Supply current	500mA max. at 24V _{DC}
Digital output	RS232
Analogue output	4—20mA; load 600Ω max. or 0—10V _{DC} ; load 10kΩ min.
Housing temperature limits	
Storage:	-10°C to +85°C
Operating:	-10°C to +85°C
Permissible gas temperatures (probe tip)	
Standard:	-100°C to +250°C
High:	-100°C to +400°C
Gas flow rate	0 to 10 m/s
Permissible acceleration	
Repetitive	5g
Incidental	30g

OUTPUT VALUES

Oxygen range (analogue output) ²	or	0.1 ¹ —25% O ₂
		0.1 ¹ —100% O ₂
Oxygen range (RS232 output)		0.1 ¹ and 100% O ₂
Accuracy after calibration ^{3, 4}		1% O ₂
Repeatability after calibration ³		0.5% O ₂
Output resolution		
Analogue 4—20mA		0.01mA
Analogue 0—10V _{DC}		0.01V
Digital RS232		0.01% O ₂
Response time		< 15s
Warm up time (prior to sensor operation)		60s
Output stabilisation time		~ 180s

Need help? Ask the expert
Tel: + 44 (0)1236 459 020
and ask for “Technical”



NOTES

- 1) Prolonged operation below 0.1% O₂ can damage the sensing element.
- 2) Range selectable by altering the position of the jumper links on the PCB; refer to PCB Layout on page 3.
- 3) Assuming barometric pressure (BP) remains constant.
- 4) As the O₂ sensor measures the partial pressure of oxygen (PPO₂) within the measurement gas deviations in the BP from that present during calibration will cause readout errors proportional to the change. EG. if the sensor reads 21% O₂ at 1013.25mbar and the BP increases by 1%, the sensor readout will also increase by 1% to 21.21% O₂.

OUTLINE DRAWING AND MOUNTING INFORMATION

All dimensions shown in mm. Tolerances = ± 1 mm.

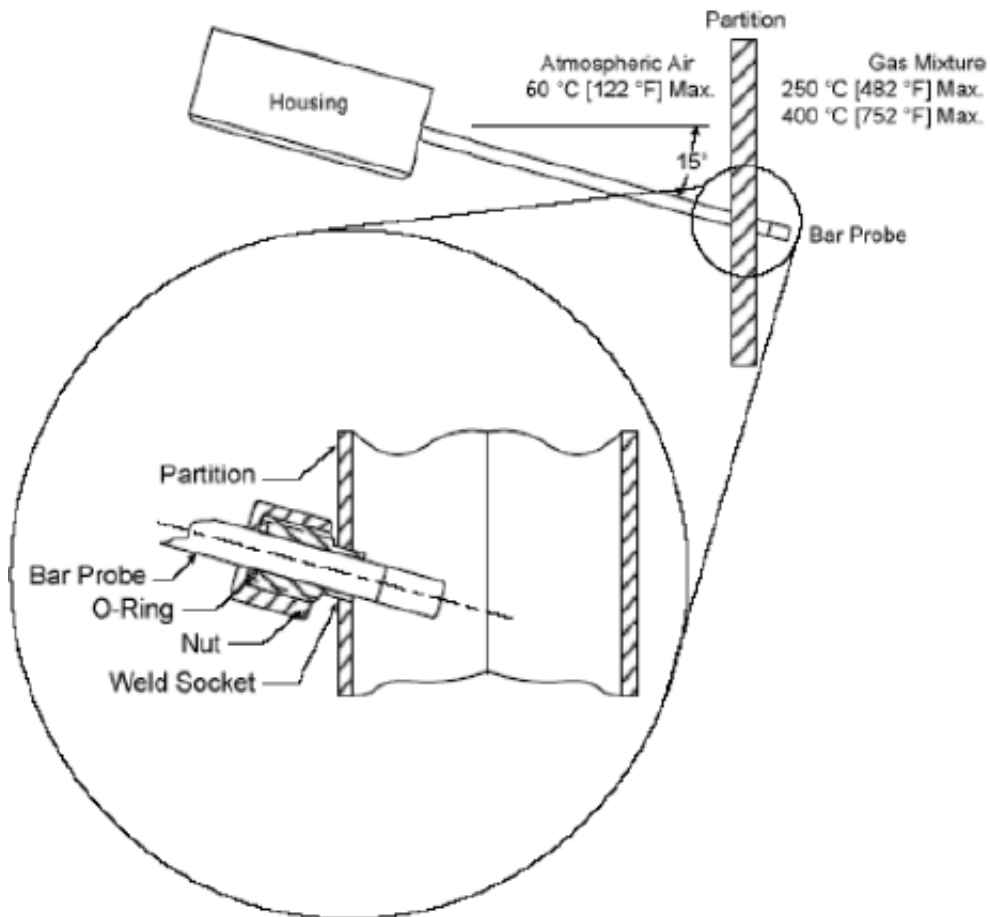
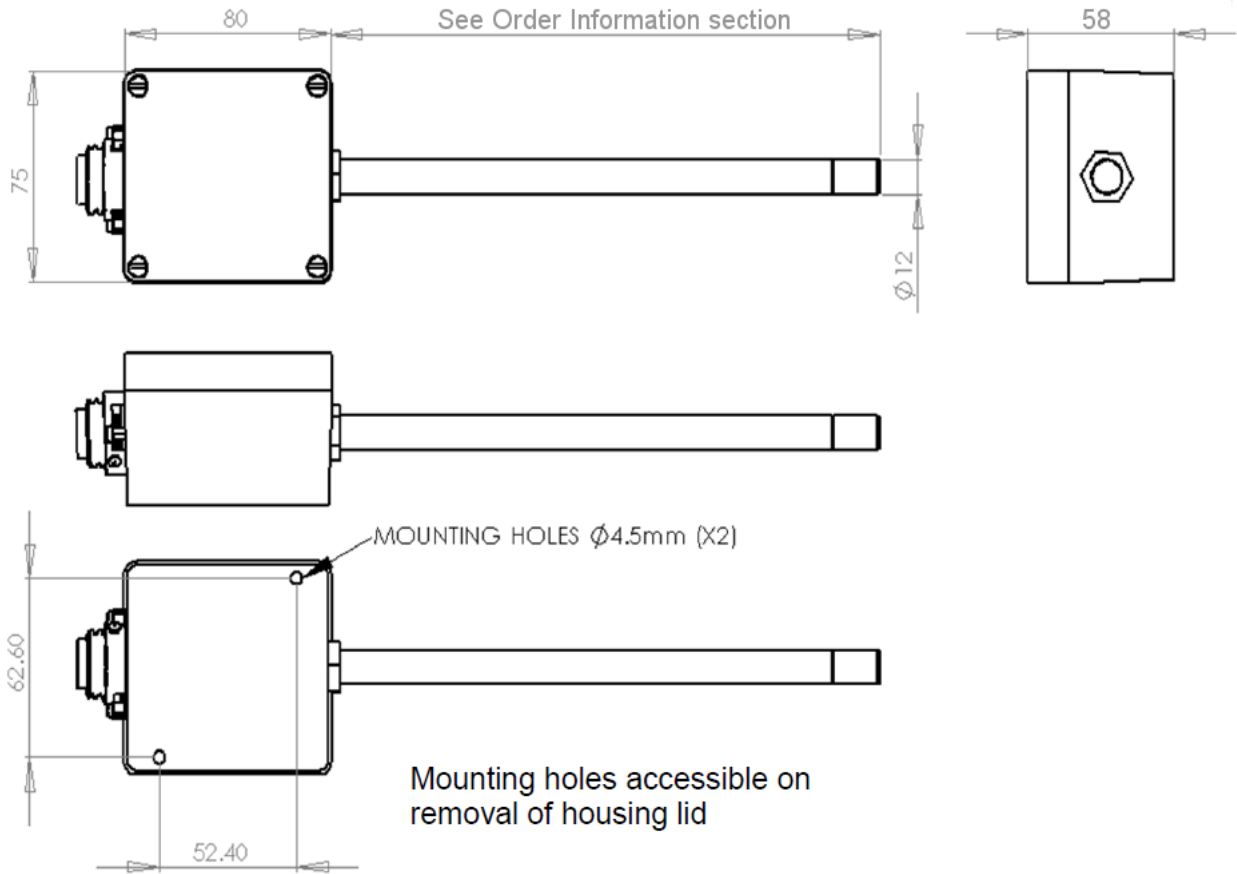

ELECTRICAL INTERFACE

Housing: Amphenol Ecomate C016 30C006 100 12

Mating Connector: Binder 99-4218-00-07

NOTE: Mating connector also supplied.

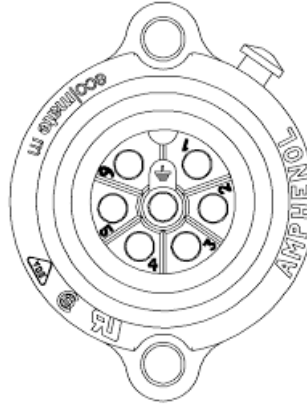

Pin	Assignment
1	24V _{DC} ±10%
2	GND
3	Calibrate
4	Cycle
5	4—20mA / RS232 Tx (see Note)
6	0—10V _{DC} / RS232 Rx (see Note)
CENTRE	Housing / Probe Earth

NOTE: Output pins 5 and 6 are both referenced to the supply GND (pin 2). Due to high current flow in the supply GND, when monitoring the 0—10V_{DC} output (pin 6) it is recommended that a separate GND wire for the measurement system is taken from pin 2. This removes errors due to voltage drops in the power supply connections.

Assignment of output pins 5 and 6 selectable by altering the position of the jumper links on the PCB; see [PCB LAYOUT](#) below.

CIRCUIT DIAGRAM AND PCB LAYOUT

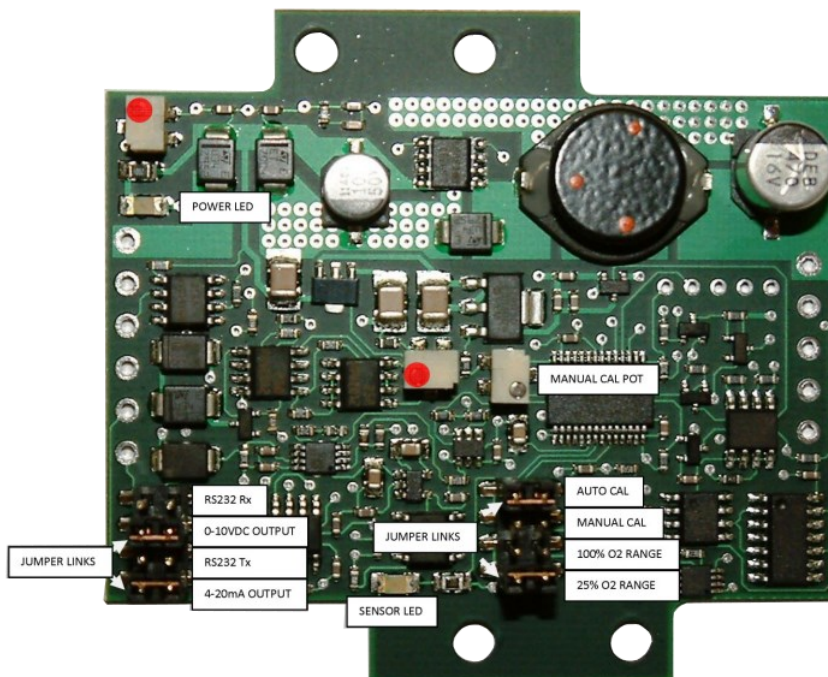
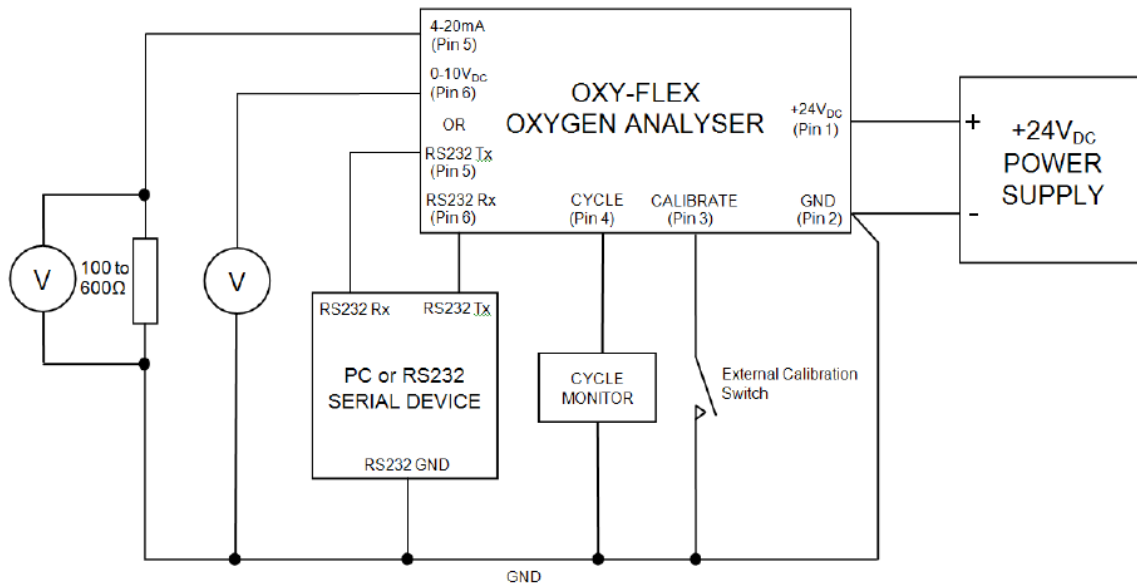



ORDER INFORMATION

Generate your specific part number using the convention shown below. Use only those letters and numbers that correspond to the options you require — omit those you do not. Include the “OXY-FLEX” prefix.

O X Y - F L E X - X - X

Probe Length	Gas Temperature
0 220mm	BLANK -100 °C to +250°C
1 400mm	H -100 °C to +400°C

! CAUTION

Do not exceed maximum ratings and ensure sensor(s) are operated in accordance with their requirements.

Carefully follow all wiring instructions. Incorrect wiring can cause permanent damage to the device.

Zirconium dioxide sensors are damaged by the presence of silicone. Vapours (organic silicone compounds) from RTV rubbers and sealants are known to poison oxygen sensors and MUST be avoided. Do NOT use chemical cleaning agents.

Failure to comply with these instructions may result in product damage.

i INFORMATION

As customer applications are outside of SST Sensing Ltd.'s control, the information provided is given without legal responsibility. Customers should test under their own conditions to ensure that the equipment is suitable for their intended application.

For technical assistance or advice, please email:
technical@sstsensing.com

General Note: SST Sensing Ltd. reserves the right to make changes to product specifications without notice or liability. All information is subject to SST Sensing Ltd.'s own data and considered accurate at time of going to print.