

SF2238E

**2560 MHz
SAW Filter**

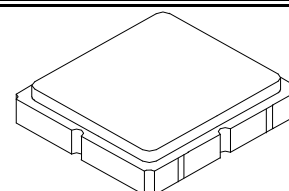

SM3030-6

- **Low-loss RF SAW Filter**
- **Surface-mount 3.0 x 3.0 x 1.3 mm Package**
- **Complies with Directive 2002/95/EC (RoHS)**
- **Moisture Sensitivity Level: 1**

Absolute Maximum Ratings

Rating	Value	Units
Input Power Level	10	dBm
DC Voltage on any Non-ground Terminal	3	V
Operating Temperature Range	-30 to +85	°C
Storage Temperature Range	-40 to +95	°C
Solder Reflow Temperature, 10 seconds, 5 cycles maximum	260	°C

Electrical Characteristics

Characteristic	Sym	Notes	Min	Typ	Max	Units
Center Frequency	F_C			2560		MHz
Maximum Insertion Loss, 2545 to 2575 MHz	IL			2.4	4.0	dB
Amplitude Ripple, 2545 to 2575MHz				0.8	2.0	dB _{p-p}
VSWR, 2545 to 2575 MHz				1.3:1	2.3:1	
Attenuation Referenced to 0 dB:						
DC to 1100 MHz			37	42.5		dB
1100 to 1880 MHz			31	42.5		
1880 to 2280 MHz			43	46		
2280 to 2420 MHz			40	43.5		
2420 to 2460 MHz			30	43		
2460 to 2490 MHz			10	23		
2635 to 2655 MHz			20	45		
2655 to 3100 MHz			41	45		
3100 to 4000 MHz			29	37		
Source Impedance	Z_S			50		Ω
Load Impedance	Z_L			50		
Case Style	SM3030-6 3.0 x 3.0 mm Nominal Footprint					
Lid Symbolization (Y=year, WW=week, S=shift) dot=pin 1 indicator	972, <u>YWW</u> S					
Standard Reel Quantity	Reel Size 7 Inch					500 Pieces/Reel
	Reel Size 13 Inch					3000 Pieces/Reel

 **CAUTION: Electrostatic Sensitive Device. Observe precautions for handling.**
NOTES:

1. The design, manufacturing process, and specifications of this device are subject to change.
2. US or International patents may apply.
3. RoHS compliant from the first date of manufacture.

Filter Response Plots

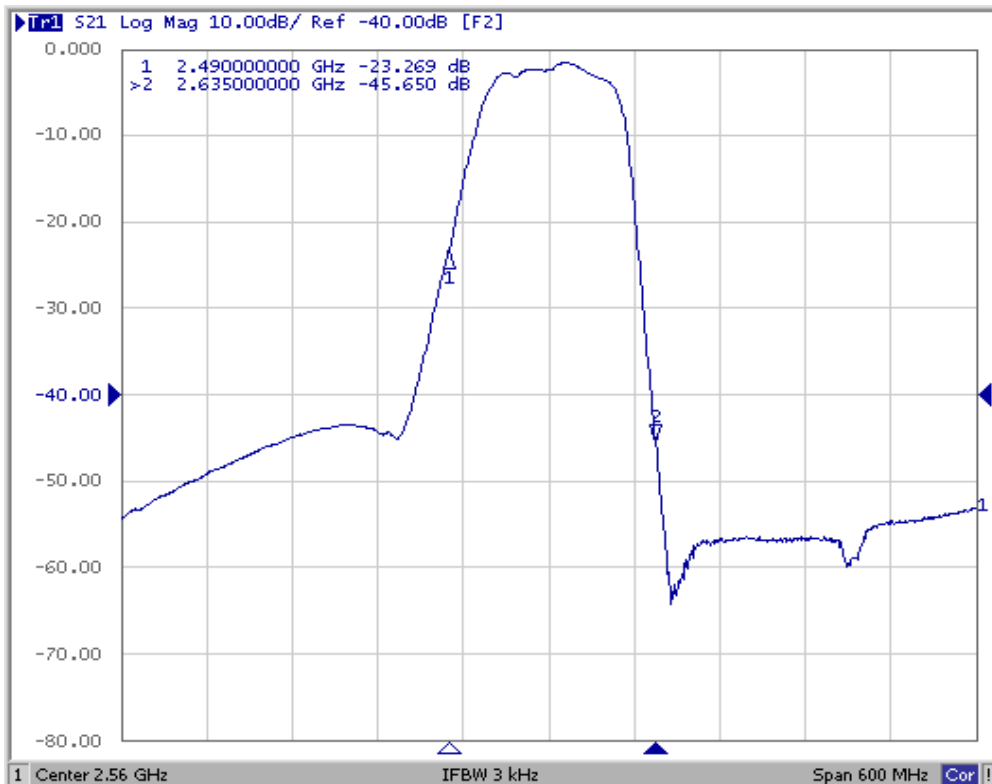
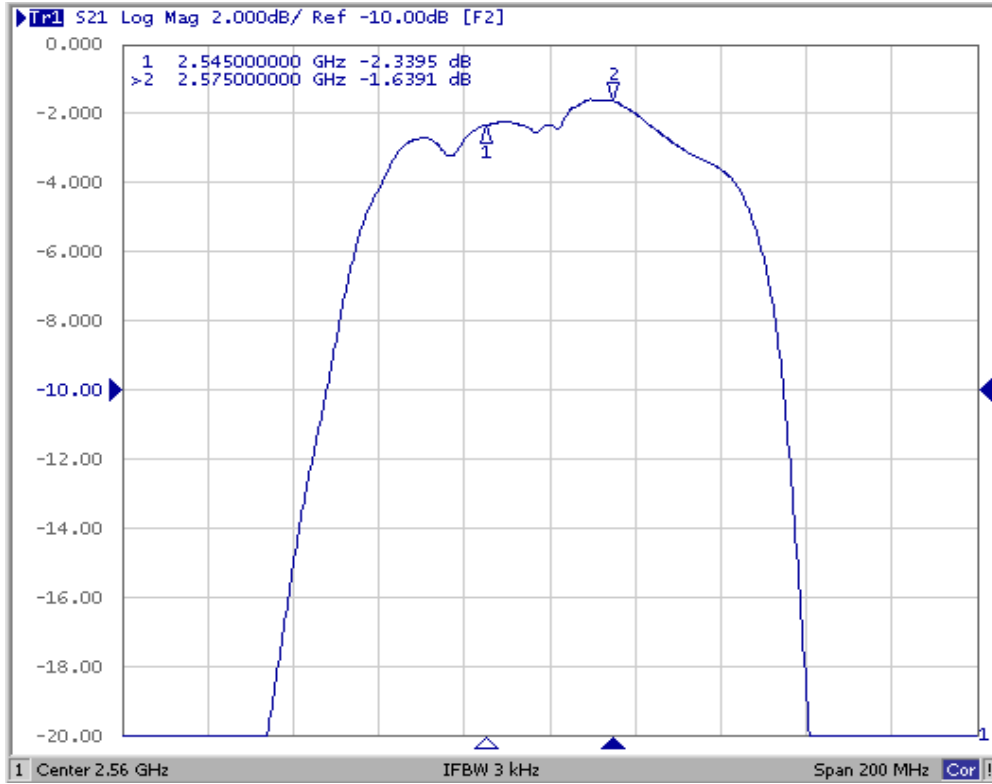

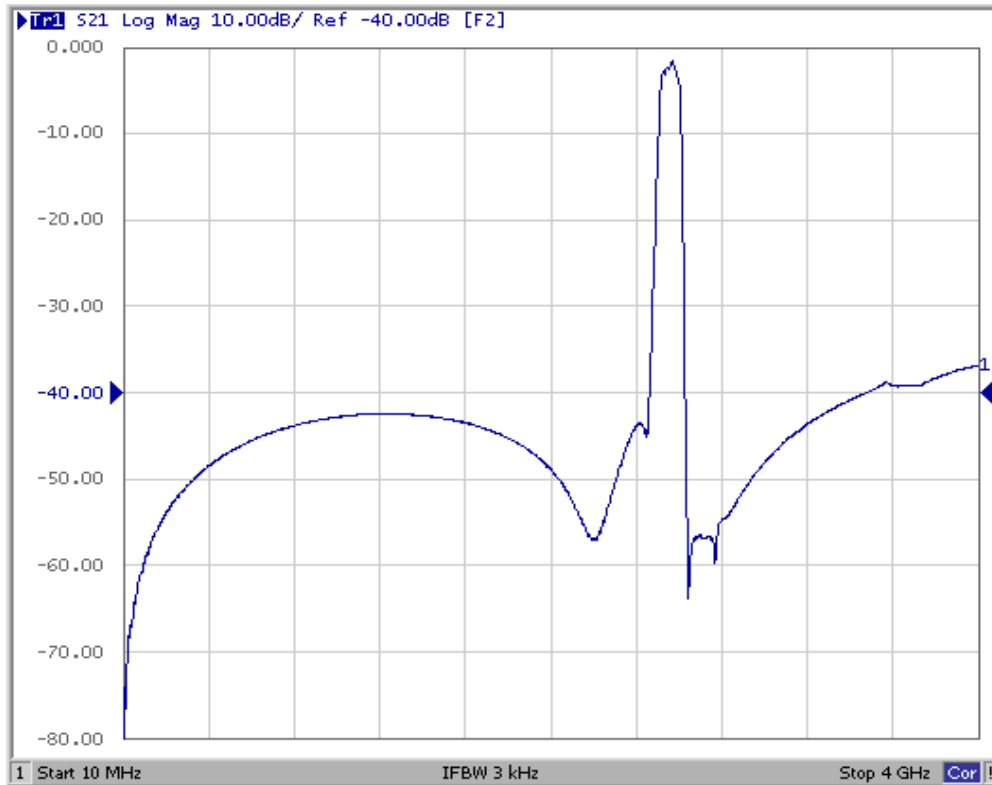

Input/Output VSWR Plots

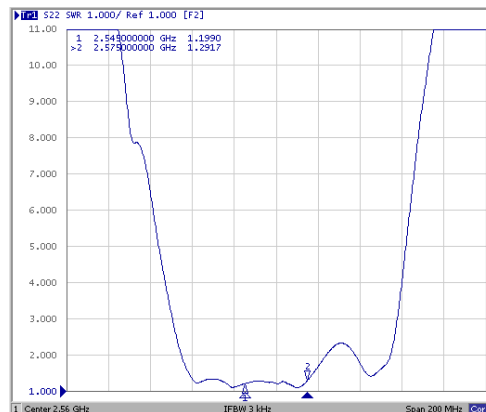
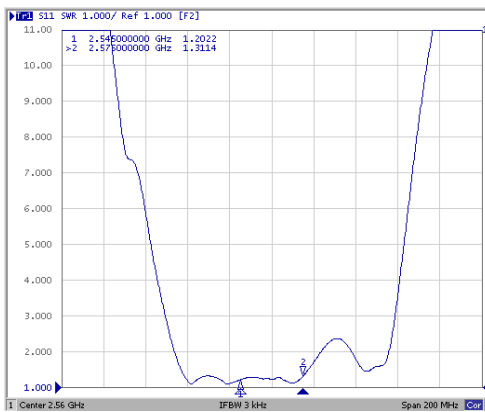

Filter Test Circuit

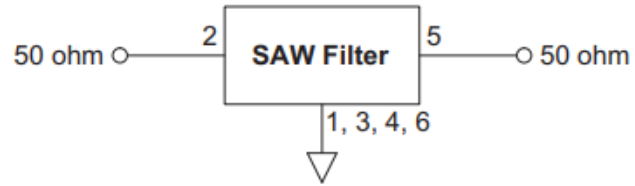

Connection	Terminals
Input	2
Output	5
Ground	All Others

SM3030-6 Case

6-Terminal Ceramic Surface-Mount Case 3.0 X 3.0 mm Nominal Footprint

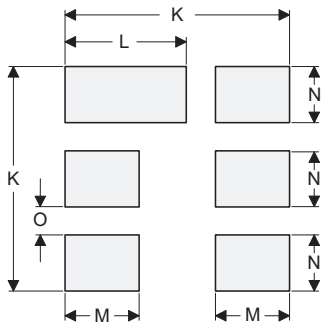
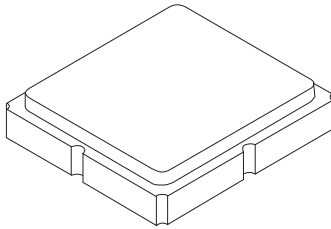

PCB Footprint Top View

Case and PCB Footprint Dimensions

Dimension	mm			Inches		
	Min	Nom	Max	Min	Nom	Max
A	2.87	3.00	3.13	0.113	0.118	0.123
B	2.87	3.00	3.13	0.113	0.118	0.123
C	1.12	1.25	1.38	0.044	0.049	0.054
D	0.77	0.90	1.03	0.030	0.035	0.040
E	2.67	2.80	2.93	0.105	0.110	0.115
F	1.47	1.60	1.73	0.058	0.063	0.068
G	0.72	0.85	0.98	0.028	0.033	0.038
H	1.37	1.50	1.63	0.054	0.059	0.064
I	0.47	0.60	0.73	0.019	0.024	0.029
J	1.17	1.30	1.43	0.046	0.051	0.056
K		3.20			0.126	
L		1.70			0.067	
M		1.05			0.041	
N		0.81			0.032	
O		0.38			0.015	

Case Materials

Materials	
Solder Pad Plating	0.3 to 1.0 μm Gold over 1.27 to 8.89 μm Nickel
Lid Plating	2.0 to 3.0 μm Nickel
Body	Al_2O_3 Ceramic

TOP VIEW

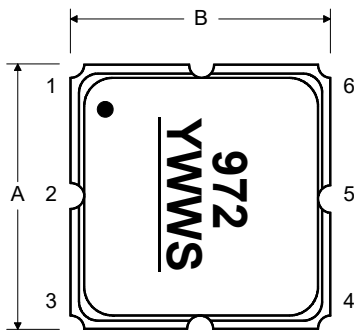

BOTTOM VIEW

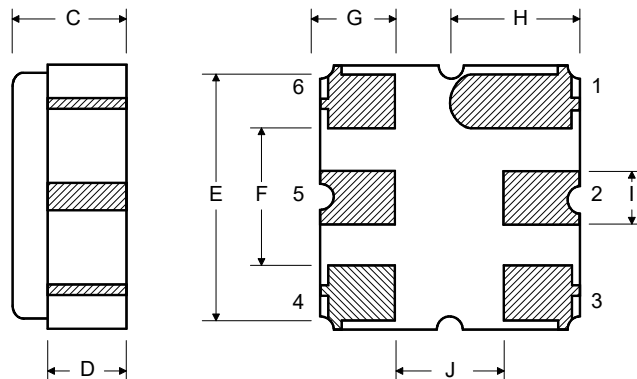

Tape and Reel Specifications

Tape and Reel Standard per ANSI/EIA-481

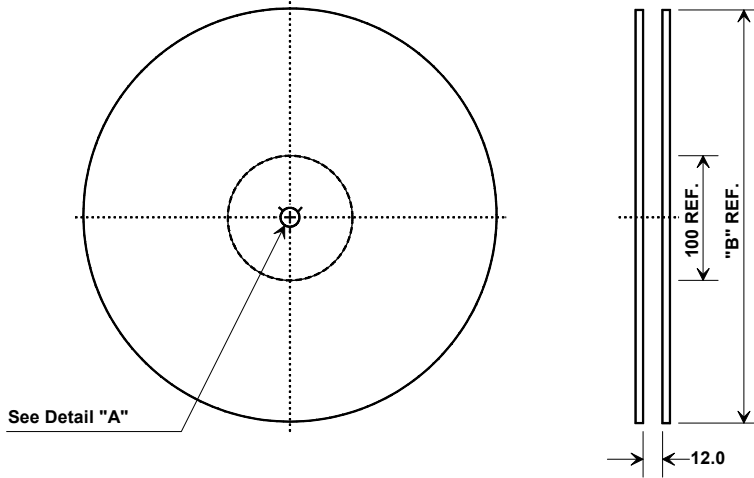

"B"		Quantity Per Reel
Inches	millimeters	
7	178	500
13	330	3000

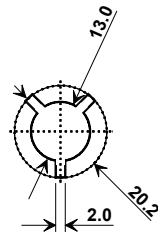

COMPONENT ORIENTATION and DIMENSIONS

Carrier Tape Dimensions	
Ao	3.35 mm
Bo	3.35 mm
Ko	1.40 mm
Pitch	8.0 mm
W	12.0 mm

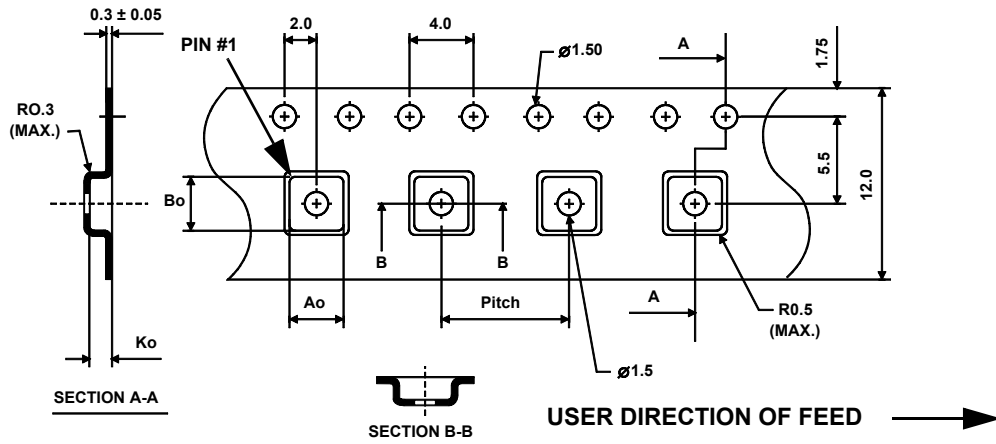

Recommended Reflow Profile

1. Preheating shall be fixed at 150~180°C for 60~90 seconds.
2. Ascending time to preheating temperature 150°C shall be 30 seconds min.
3. Heating shall be fixed at 220°C for 50~80 seconds and at 260°C +0/-5°C peak (10 seconds).
4. Time: 5 times maximum.

