

20 W HMIC Silicon PIN Diode Terminated SPDT Switch 8.0 - 10.5 GHz

Rev. V1

Features

- Low Insertion Loss: 1 dB
- High Isolation: 38 dB
- Integrated Bias Network and Termination Circuit
- Greater than 20 W CW Power Handling @ +70°C
- Lead-Free 7 mm 44-lead PQFN Package
- Halogen-Free “Green” Mold Compound
- RoHS* Compliant

Description

The MASW-011071 is a terminated silicon PIN diode SPDT switch designed for X-Band high power, high performance applications. The switch is assembled in a lead-free 7 mm 44-lead PQFN plastic package and handles greater than 20 W of CW power over the 8.0 - 10.5 GHz frequency band.

The device is fabricated using MACOM's patented HMIC process, which allows for the integration of silicon pedestals that embed series and shunt diodes in low loss, low dispersion glass. The switch offers 1 dB insertion loss as well as 38 dB isolation performance. The device integrates a bias network to allow for simplified bias application and switch control.

Functional Diagram

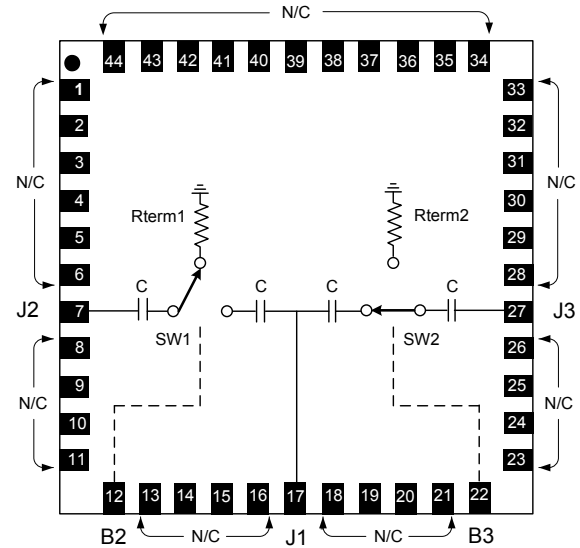

Pin Configuration

Pin	Port	Function
7	J2	RF _{OUT}
12	B2	Bias of J2
17	J1	RF _{COMMON}
22	B3	Bias of J3
27	J3	RF _{OUT}
1-6, 8-11, 13-16, 18-21, 23-26, 28-44	N/C	No Connection ³
45	Pad	Ground ⁴

Ordering Information^{1,2}

Part Number	Package
MASW-011071-TR0500	500 piece reel
MASW-011071-001SMB	Sample Board

1. Reference Application Note M513 for reel size information.
2. All sample boards include 3 loose parts.

3. MACOM recommends connecting all No Connection (N/C) pins to ground.
4. The paddle on the package bottom must be connected to RF, DC and thermal ground.

* Restrictions on Hazardous Substances, European Union Directive 2011/65/EU.

20 W HMIC Silicon PIN Diode Terminated SPDT Switch 8.0 - 10.5 GHz

Rev. V1

Electrical Specifications⁵: $T_A = +25^\circ\text{C}$, $Z_0 = 50 \Omega$, $P_{IN} = 0 \text{ dBm}$ (unless otherwise noted)

Parameter	Test Conditions	Units	Min.	Typ.	Max.
Insertion Loss	8.0 GHz	dB	—	0.9	—
	8.5 GHz			1.0	—
	9.5 GHz			1.0	1.4
	10.5 GHz			1.2	—
Input to Output Isolation	8.0 GHz	dB	—	36	—
	8.5 GHz		—	37	
	9.5 GHz		32	39	
	10.5 GHz		—	38	
Input Return Loss	8.0 GHz	dB	—	26	—
	8.5 GHz			26	
	9.5 GHz			31	
	10.5 GHz			19	
Return Loss (Termination)	8.0 GHz	dB	—	12	—
	8.5 GHz		—	16	
	9.5 GHz		14	28	
	10.5 GHz		—	18	
P0.1dB	9.5 GHz (+5 V, -30 V)	dBm	—	44.5	—
Input IP3	10 GHz, +20 dBm, 10 MHz spacing	dBm	—	60	—
Switching Speed ⁶	10 GHz, +/- 4 V, PW 500 ns, 50% duty cycle	ns	—	130	—

5. See Driver Connections table.

6. Typical switching speed measured from 10% to 90 % of detected RF signal driven by TTL compatible drivers. MACOM recommends the MADR-007097, Complementary Channel TTL PIN Diode Driver.

Bias Control⁷

Optimal operation is achieved by simultaneous application of negative DC voltage to the low loss switch path and positive DC voltage to the isolating switch path.

In the low loss path, the diodes are reverse biased. In the isolating path, the diodes are forward biased.

Minimum Reverse Bias Required:

At X-Band, with a 1:1 match, 5 V of reverse bias is required. With a 4:1 match, 10 V of reverse bias is required.

However MACOM recommends 30 V of reverse bias to achieve optimal operating conditions.

Driver Connections

DC Control Voltages (DC Currents)		Condition of RF Output	
B2	B3	J1-J2	J1-J3
-5 V ⁷ (0 mA)	+5 V (55 mA typ.)	Insertion Loss	Isolation
+5 V (55 mA typ.)	-5 V ⁷ (0 mA)	Isolation	Insertion Loss

7. R. Caverly and G. Hiller, "Establishing the Minimum Reverse Bias for a P-I-N Diode in a High Power Switch," IEEE Transactions on Microwave Theory and Techniques, Vol.38, No.12, December 1990.

Absolute Maximum Ratings^{8,9}

Parameter	Absolute Maximum
Applied Reverse Voltage	100 V
Bias Current	100 mA @ +70°C
RF CW Incident Power (Transmission)	20 W @ +70°C
RF CW Incident Power (Termination)	1 W @ +70°C
Junction Temperature	+175°C
Operating Temperature	-40°C to +70°C
Storage Temperature	-65°C to +150°C

- 8. Exceeding any one or combination of these limits may cause permanent damage to this device.
- 9. MACOM does not recommend sustained operation near these survivability limits.

Handling Procedures

Please observe the following precautions to avoid damage:

Static Sensitivity

Integrated Circuits are sensitive to electrostatic discharge (ESD) and can be damaged by static electricity. Proper ESD control techniques should be used when handling these HBM Class 1A devices.

Functional Schematic

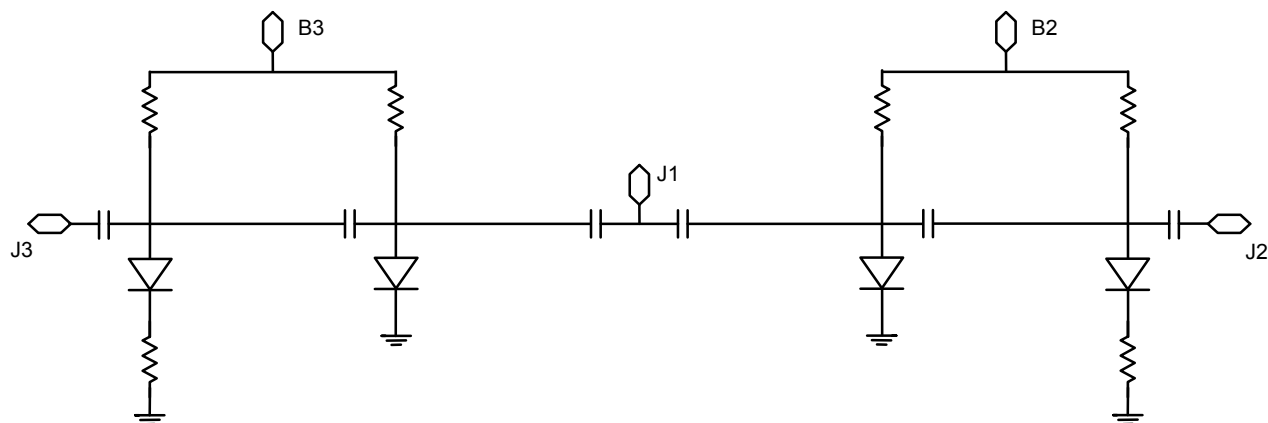

20 W HMIC Silicon PIN Diode Terminated SPDT Switch 8.0 - 10.5 GHz

Rev. V1

Typical Performance: Bias = ± 5 V, $P_{IN} = 0$ dBm (Unless otherwise stated)

Insertion Loss vs. Frequency

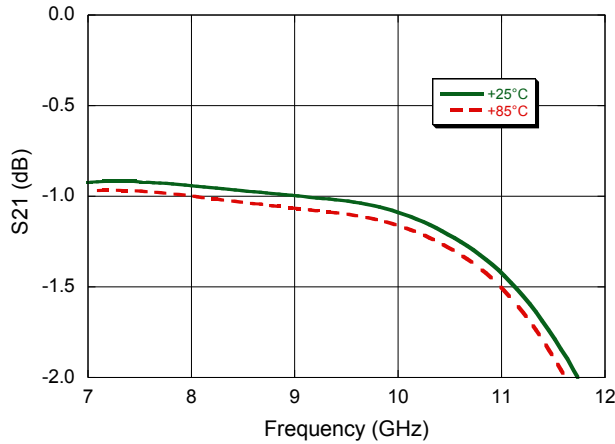

Isolation vs. Frequency

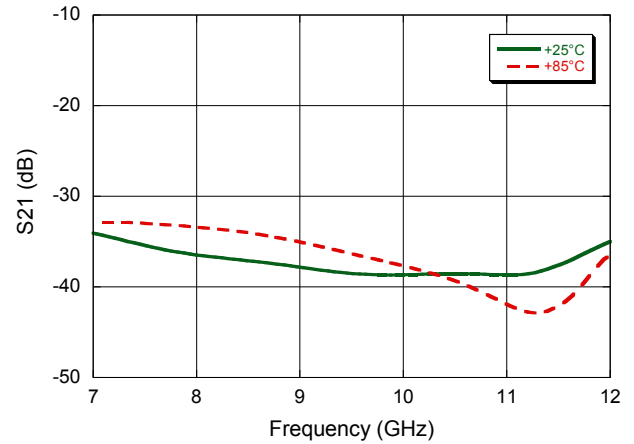

Input Return Loss vs. Frequency (Transmission)

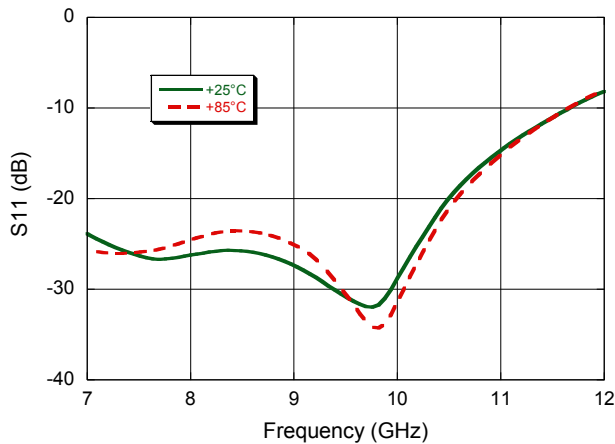

Output Return Loss vs. Frequency (Termination)

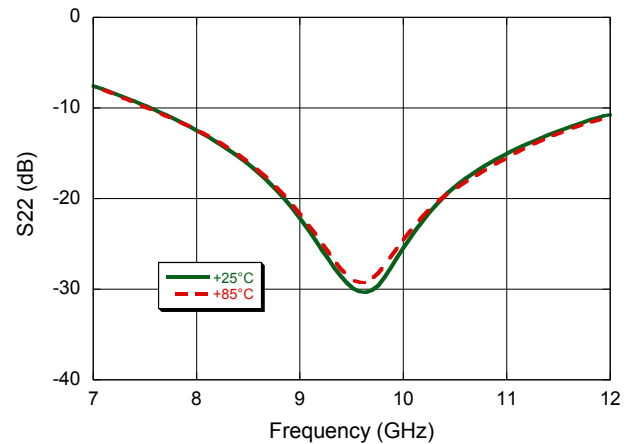

Insertion Loss vs. Bias Voltage, 9.5 GHz, 43 dBm CW

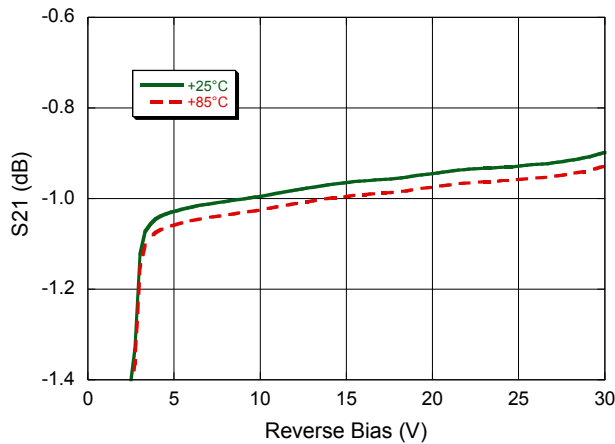

Insertion Loss vs. CW Power, 9.5 GHz, -30 V

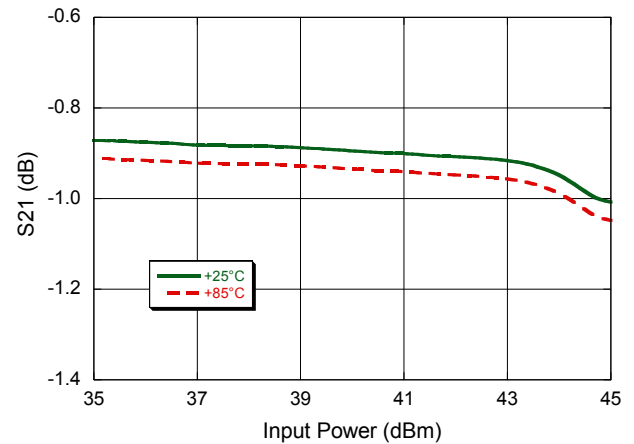

20 W HMIC Silicon PIN Diode Terminated SPDT Switch 8.0 - 10.5 GHz

Rev. V1

Outline Drawing

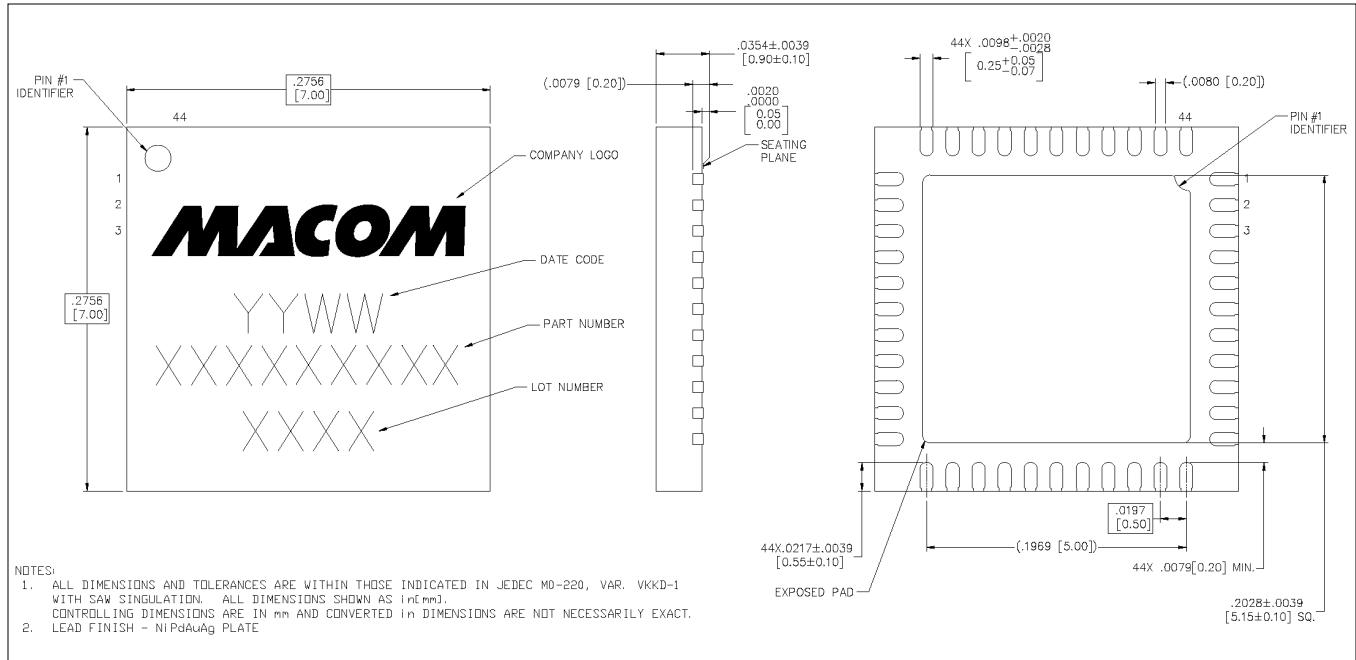

- † Reference Application Note S2083 for lead-free solder reflow recommendations.
 Meets JEDEC moisture sensitivity level 1 requirements.
 Plating is NiPdAuAg.

M/A-COM Technology Solutions Inc. All rights reserved.

Information in this document is provided in connection with M/A-COM Technology Solutions Inc ("MACOM") products. These materials are provided by MACOM as a service to its customers and may be used for informational purposes only. Except as provided in MACOM's Terms and Conditions of Sale for such products or in any separate agreement related to this document, MACOM assumes no liability whatsoever. MACOM assumes no responsibility for errors or omissions in these materials. MACOM may make changes to specifications and product descriptions at any time, without notice. MACOM makes no commitment to update the information and shall have no responsibility whatsoever for conflicts or incompatibilities arising from future changes to its specifications and product descriptions. No license, express or implied, by estoppels or otherwise, to any intellectual property rights is granted by this document.

THESE MATERIALS ARE PROVIDED "AS IS" WITHOUT WARRANTY OF ANY KIND, EITHER EXPRESS OR IMPLIED, RELATING TO SALE AND/OR USE OF MACOM PRODUCTS INCLUDING LIABILITY OR WARRANTIES RELATING TO FITNESS FOR A PARTICULAR PURPOSE, CONSEQUENTIAL OR INCIDENTAL DAMAGES, MERCHANTABILITY, OR INFRINGEMENT OF ANY PATENT, COPYRIGHT OR OTHER INTELLECTUAL PROPERTY RIGHT. MACOM FURTHER DOES NOT WARRANT THE ACCURACY OR COMPLETENESS OF THE INFORMATION, TEXT, GRAPHICS OR OTHER ITEMS CONTAINED WITHIN THESE MATERIALS. MACOM SHALL NOT BE LIABLE FOR ANY SPECIAL, INDIRECT, INCIDENTAL, OR CONSEQUENTIAL DAMAGES, INCLUDING WITHOUT LIMITATION, LOST REVENUES OR LOST PROFITS, WHICH MAY RESULT FROM THE USE OF THESE MATERIALS.

MACOM products are not intended for use in medical, lifesaving or life sustaining applications. MACOM customers using or selling MACOM products for use in such applications do so at their own risk and agree to fully indemnify MACOM for any damages resulting from such improper use or sale.