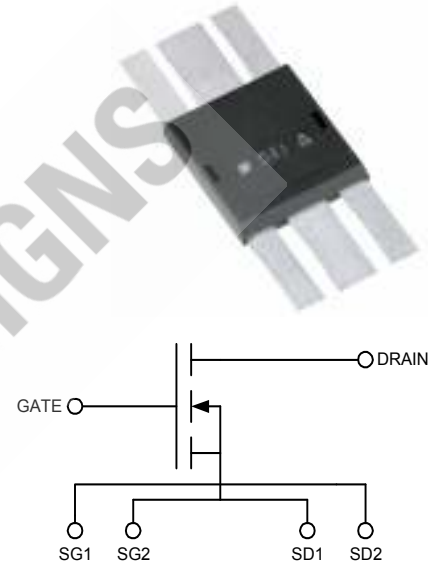

N-Channel Enhancement Mode  
 Low  $Q_g$  and  $R_g$   
 High  $dv/dt$   
 Nanosecond Switching  
 Ideal for Class C, D, & E Applications

$V_{DSS} = 1000\text{ V}$   
 $I_{D25} = 8\text{ A}$   
 $R_{DS(on)} = 1.5\ \Omega$   
 $P_{DC} = 590\text{ W}$

Symbol	Test Conditions	Maximum Ratings	
$V_{DSS}$	$T_J = 25^\circ\text{C}$ to $150^\circ\text{C}$	1000	V
$V_{DGR}$	$T_J = 25^\circ\text{C}$ to $150^\circ\text{C}$ ; $R_{GS} = 1\text{ M}\Omega$	1000	V
$V_{GS}$	Continuous	$\pm 20$	V
$V_{GSM}$	Transient	$\pm 30$	V
$I_{D25}$	$T_c = 25^\circ\text{C}$	8	A
$I_{DM}$	$T_c = 25^\circ\text{C}$ , pulse width limited by $T_{JM}$	48	A
$I_{AR}$	$T_c = 25^\circ\text{C}$	6	A
$E_{AR}$	$T_c = 25^\circ\text{C}$	20	mJ
$dv/dt$	$I_S \leq I_{DM}$ , $di/dt \leq 100\text{ A}/\mu\text{s}$ , $V_{DD} \leq V_{DSS}$ , $T_J \leq 150^\circ\text{C}$ , $R_G = 0.2\ \Omega$	5	V/ns
	$I_S = 0$	>200	V/ns
$P_{DC}$		590	W
$P_{DHS}$	$T_c = 25^\circ\text{C}$ Derate $2.0\text{ W}/^\circ\text{C}$ above $25^\circ\text{C}$	300	W
$P_{DAMB}$	$T_c = 25^\circ\text{C}$	3.0	W
$R_{thJC}$		0.25	C/W
$R_{thJHS}$		0.50	C/W

Symbol	Test Conditions	Characteristic Values		
		min.	typ.	max.
$T_J = 25^\circ\text{C}$ unless otherwise specified				
$V_{DSS}$	$V_{GS} = 0\text{ V}$ , $I_D = 3\text{ mA}$	1000		V
$V_{GS(th)}$	$V_{DS} = V_{GS}$ , $I_D = 250\ \mu\text{A}$	3.5		V
$I_{GSS}$	$V_{GS} = \pm 20\text{ V}_{DC}$ , $V_{DS} = 0$			$\pm 100\text{ nA}$
$I_{DSS}$	$V_{DS} = 0.8\text{ V}_{DSS}$ , $T_J = 25^\circ\text{C}$ $V_{GS} = 0$ , $T_J = 125^\circ\text{C}$			50 $\mu\text{A}$
				1 mA
$R_{DS(on)}$	$V_{GS} = 15\text{ V}$ , $I_D = 0.5I_{D25}$ Pulse test, $t \leq 300\ \mu\text{s}$ , duty cycle $d \leq 2\%$		1.5	$\Omega$
$g_{fs}$	$V_{DS} = 20\text{ V}$ , $I_D = 0.5I_{D25}$ , pulse test	2.5	4.3	7 S
$R_{thJHS}$			0.50	C/W
$T_J$		-55		+175 $^\circ\text{C}$
$T_{JM}$			175	$^\circ\text{C}$
$T_{stg}$		-55		+175 $^\circ\text{C}$
$T_L$	1.6mm (0.063 in) from case for 10 s		300	$^\circ\text{C}$
<b>Weight</b>			2	g

**Features**

- Isolated Substrate
  - high isolation voltage (>2500V)
  - excellent thermal transfer
  - Increased temperature and power cycling capability
- IXYS advanced low  $Q_g$  process
- Low gate charge and capacitances
  - easier to drive
  - faster switching
- Low  $R_{DS(on)}$
- Very low insertion inductance (<2nH)
- No beryllium oxide (BeO) or other hazardous materials

**Advantages**

- Optimized for RF and high speed switching at frequencies to 100MHz
- Easy to mount—no insulators needed
- High power density

Symbol	Test Conditions	Characteristic Values		
		min.	typ.	max.
(T <sub>J</sub> = 25°C unless otherwise specified)				
R <sub>G</sub>			0.3	Ω
C <sub>iss</sub>			1650	pF
C <sub>oss</sub>	V <sub>GS</sub> = 0 V, V <sub>DS</sub> = 0.8 V <sub>DSS(max)</sub> , f = 1 MHz		80	pF
C <sub>rss</sub>			18	pF
C <sub>stray</sub>	Back Metal to any Pin		21	pF
T <sub>d(on)</sub>			3	ns
T <sub>on</sub>	V <sub>GS</sub> = 15 V, V <sub>DS</sub> = 0.8 V <sub>DSS</sub> I <sub>D</sub> = 0.5 I <sub>DM</sub>		2	ns
T <sub>d(off)</sub>	R <sub>G</sub> = 0.2 Ω (External)		4	ns
T <sub>off</sub>			5	ns
Q <sub>g(on)</sub>			46	nC
Q <sub>gs</sub>	V <sub>GS</sub> = 10 V, V <sub>DS</sub> = 0.5 V <sub>DSS</sub> I <sub>D</sub> = 0.5 I <sub>D25</sub> I <sub>G</sub> = 3mA		8	nC
Q <sub>gd</sub>			25	nC

Source-Drain Diode		Characteristic Values		
(T <sub>J</sub> = 25°C unless otherwise specified)				
Symbol	Test Conditions	min.	typ.	max.
I <sub>S</sub>	V <sub>GS</sub> = 0 V			6 A
I <sub>SM</sub>	Repetitive; pulse width limited by T <sub>JM</sub>			48 A
V <sub>SD</sub>	I <sub>F</sub> = I <sub>S</sub> , V <sub>GS</sub> = 0 V, Pulse test, t ≤ 300 μs, duty cycle ≤ 2%			1.5 V
T <sub>rr</sub>			200	ns
Q <sub>RM</sub>	I <sub>F</sub> = I <sub>S</sub> , -di/dt = 100A/μs, V <sub>R</sub> = 100V		0.6	μC
I <sub>RM</sub>			4	A

CAUTION: Operation at or above the Maximum Ratings values may impact device reliability or cause permanent damage to the device.

Information in this document is believed to be accurate and reliable. IXYSRF reserves the right to make changes to information published in this document at any time and without notice.

For detailed device mounting and installation instructions, see the "Device Installation & Mounting Instructions" technical note on the IXYSRF web site at;

[http://www.ixysrf.com/pdf/switch\\_mode/appnotes/7de\\_series\\_mosfet\\_installation\\_instructions.pdf](http://www.ixysrf.com/pdf/switch_mode/appnotes/7de_series_mosfet_installation_instructions.pdf)

IXYS RF reserves the right to change limits, test conditions and dimensions.

IXYS RF MOSFETS are covered by one or more of the following U.S. patents:

4,835,592	4,860,072	4,881,106	4,891,686	4,931,844	5,017,508
5,034,796	5,049,961	5,063,307	5,187,117	5,237,481	5,486,715
5,381,025	5,640,045				

Fig. 1 **Typical Output Characteristics**

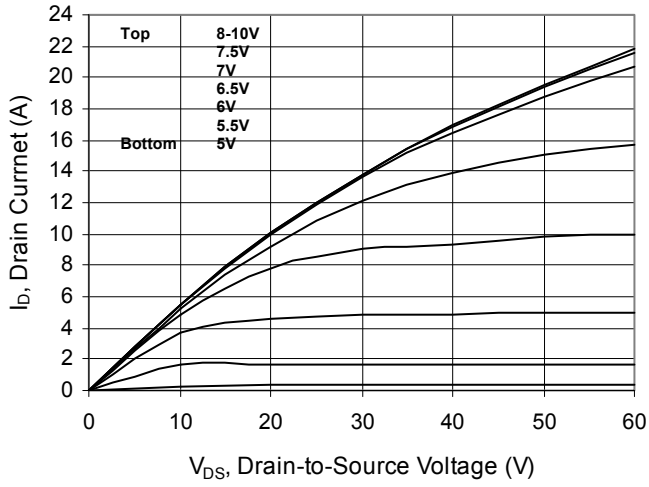

Fig. 2 **Typical Transfer Characteristics**  
 $V_{DS} = 60V$   $PW = 4\mu S$

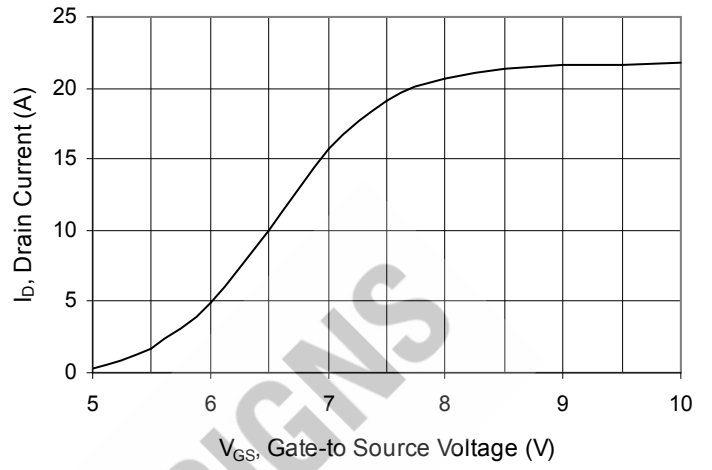

Fig. 3 **Gate-to-Source Voltage vs. Gate Charge**  
 $V_{DS} = 500V$   $I_D = 4A$

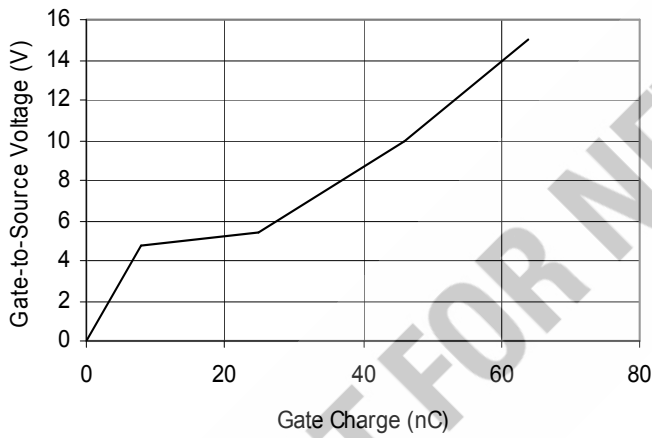
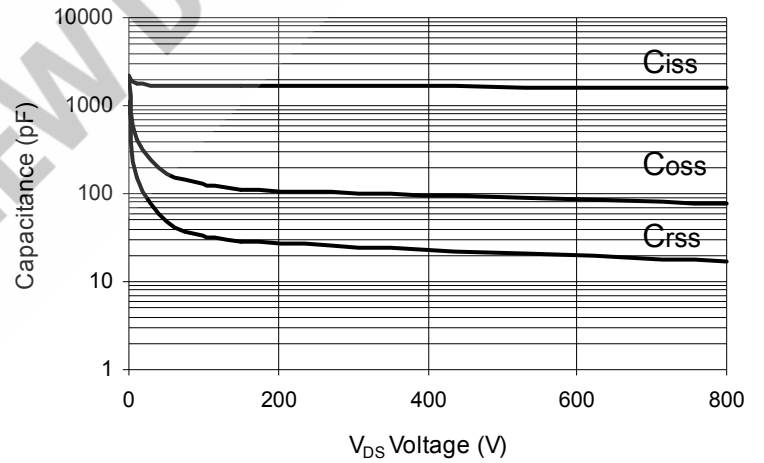
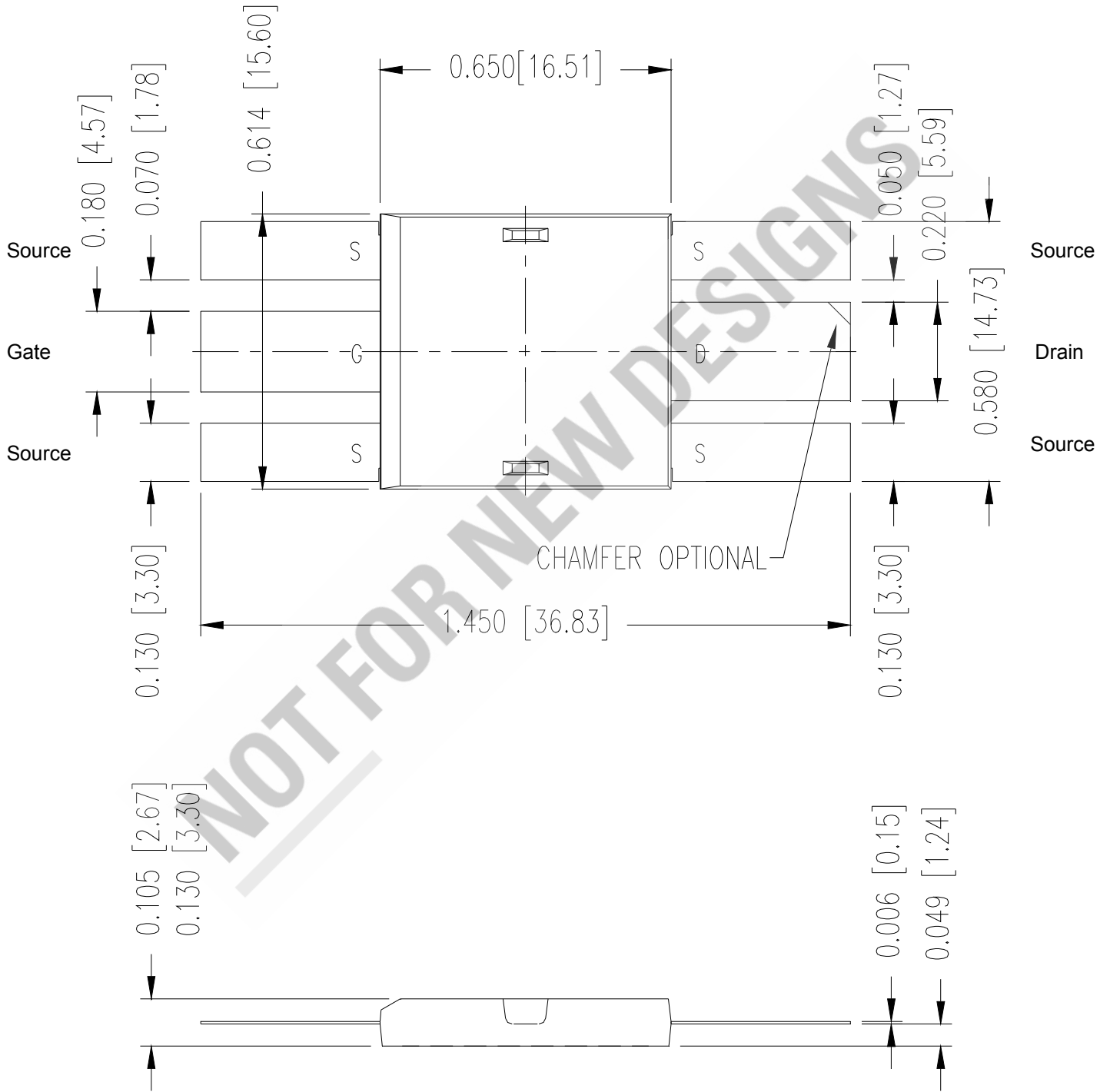

Fig. 4  **$V_{DS}$  vs. Capacitance**



**Fig. 5 Package Drawing**



**Fig. 6 Class C Test Circuit**

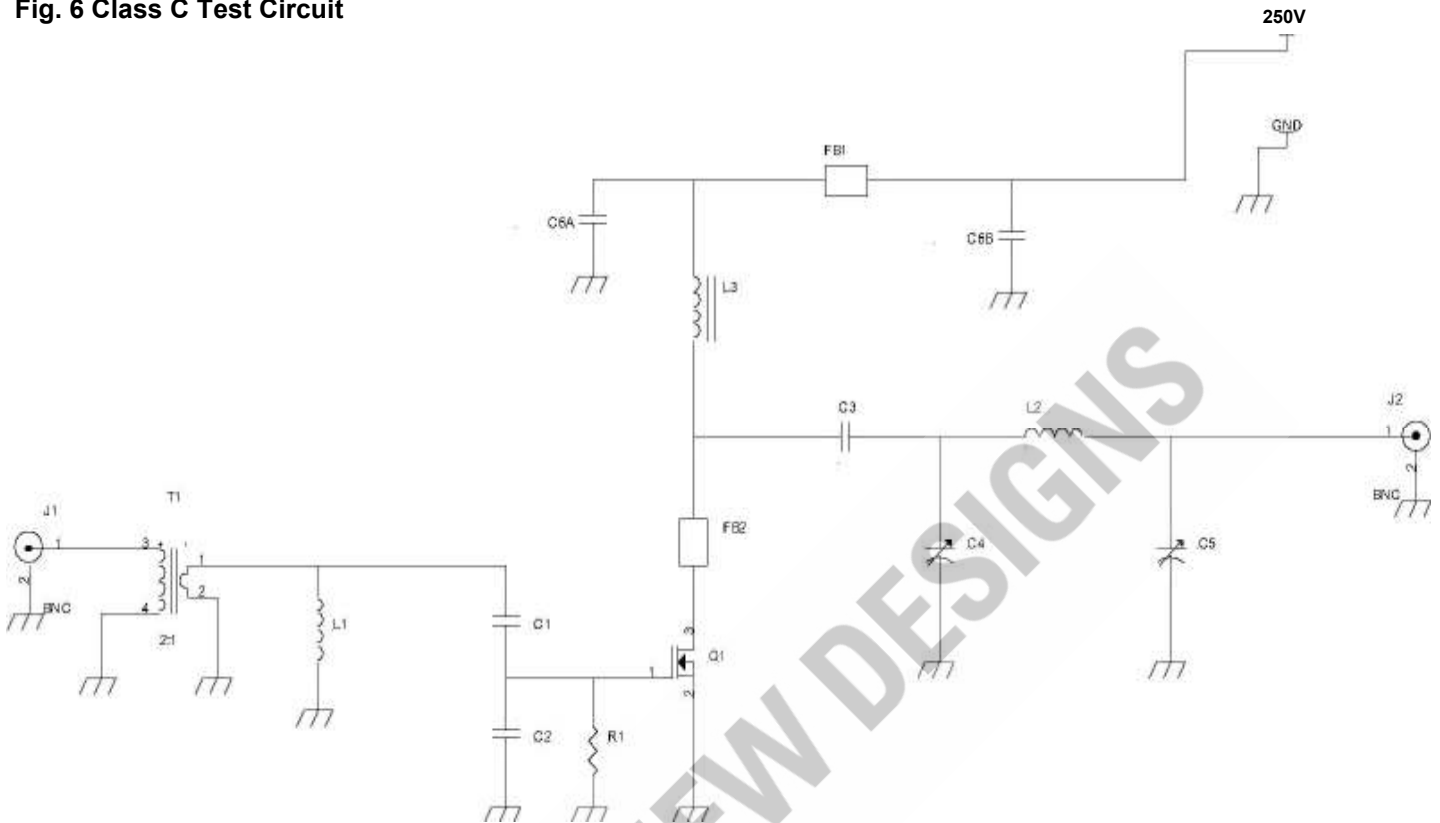

**13.56MHz Class C RF Test Circuit**

1. T1- 2:1 Turns ratio, Ferronics binocular core P/N 12-365-J

Primary - 2 turns of 26 AWG, single strand Teflon Wire.  
Secondary - 1 turn of braid with the primary wire run inside of it.

2. L1 - < 90nH, 5 turns, 0.25" id, 18 AWG single strand magnet wire, 0.55" long.

3. C1 - 3000pf, 3 x 1000pf, ATC capacitors, P/N 102KW.

4. C2 - 470pf, ATC capacitor, P/N 471JW.

5. R1 - 3.3 ohm, 3 x 10 ohm Caddock resistors, P/N MP850-10-10.

6. Q1 - DE275-102N06A

7. C3 - 5nf, 5 x .001uf, ceramic disc capacitors

8. C4 - 60pf - 100pf air variable capacitor

9. L2 - 800nH, 6 turns, 1" id, 12 AWG single strand magnet wire, 0.85" long.

10. C5 - 250pf - 480pf mica compression capacitor, Sprague Goodman GME90901.

11. L3 - 5.4uH, 20 turns, 18 AWG single strand magnet wire, Micrometals core T-106-2, powdered iron core.

12. C6A - 0.02uf, 2 x 0.01uf ceramic disc capacitors.

13. C6B - 0.08uf, 8 x 0.01uf ceramic disc capacitors.

14. FB1 - 3 x 900mu ferrite beads on 18 AWG buss wire.

102N06A DE-SERIES SPICE Model

The DE-SERIES SPICE Model is illustrated in Figure 7. The model is an expansion of the SPICE level 3 MOSFET model. It includes the stray inductive terms  $L_G$ ,  $L_S$  and  $L_D$ .  $R_d$  is the  $R_{DS(ON)}$  of the device,  $R_{ds}$  is the resistive leakage term. The output capacitance,  $C_{OSS}$ , and reverse transfer capacitance,  $C_{RSS}$  are modeled with reversed biased diodes. This provides a varactor type response necessary for a high power device model. The turn on delay and the turn off delay are adjusted via  $R_{on}$  and  $R_{off}$ .

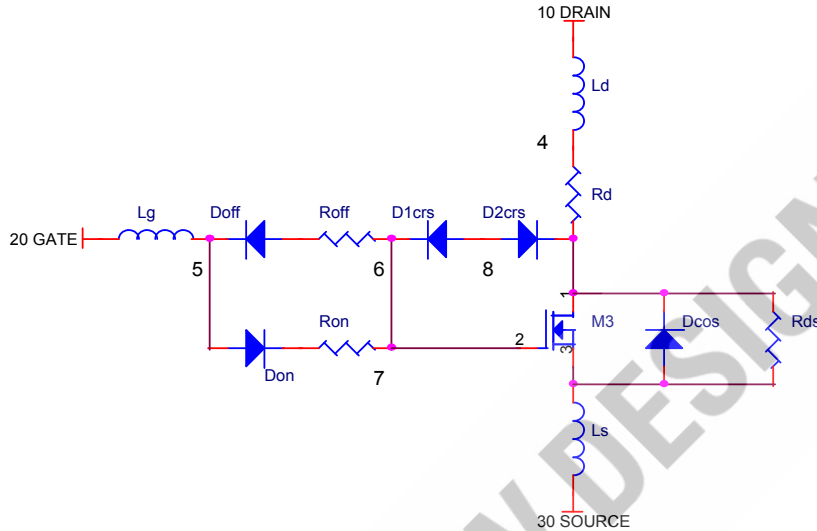

Figure 7 DE-SERIES SPICE Model

This SPICE model may be downloaded as a text file from the IXYSRF web site at

[http://www.ixysrf.com/products/switch\\_mode.html](http://www.ixysrf.com/products/switch_mode.html)

<http://www.ixysrf.com/spice/de275-102n06a.html>

Net List:

```
*SYM=POWMOSN
.SUBCKT 102N06A 10 20 30
* TERMINALS: D G S
* 1000 Volt 6 Amp 1.6 Ohm N-Channel Power MOSFET
M1 1 2 3 3 DMOS L=1U W=1U
RON 5 6 .5
DON 6 2 D1
ROF 5 7 1.0
DOF 2 7 D1
D1CRS 2 8 D2
D2CRS 1 8 D2
CGS 2 3 1.9N
RD 4 1 1.6
DCOS 3 1 D3
RDS 1 3 5.0MEG
LS 3 30 .5N
LD 10 4 1N
LG 20 5 1N
.MODEL DMOS NMOS (LEVEL=3 VTO=4 KP=2.3)
.MODEL D1 D (IS=.5F CJO=10P BV=100 M=.5 VJ=.2 TT=1N)
.MODEL D2 D (IS=.5F CJO=400P BV=1000 M=.6 VJ=.6 TT=1N RS=10M)
.MODEL D3 D (IS=.5F CJO=400P BV=1000 M=.35 VJ=.6 TT=400N RS=10M)
.ENDS
```

Doc #9200-0221 Rev 5  
© 2009 IXYS RF