

CGH21240F

240 W, 1.8 - 2.3 GHz, GaN HEMT
for WCDMA, LTE, WiMAX

Description

WolfSpeed's CGH21240F is a gallium nitride (GaN) high electron mobility transistor (HEMT) designed specifically with high efficiency, high gain and wide bandwidth capabilities, which makes the CGH21240F ideal for 1.8-2.3 GHz WCDMA and LTE amplifier applications. The transistor is supplied in a ceramic/metal flange package.

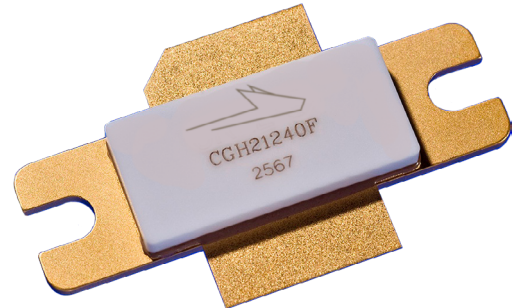

Package Types: 440117
PN: CGH21240F

Typical Performance Over 2.0-2.3 GHz ($T_c = 25^\circ\text{C}$) of Demonstration Amplifier

Parameter	2.0 GHz	2.1 GHz	2.2 GHz	2.3 GHz	Unit
Gain @ 46 dBm	13.1	14.6	15.1	15.7	dB
ACLR @ 46 dBm	-36.5	-34.5	-34.2	-32.0	dBc
Drain Efficiency @ 46 dBm	30.5	32.7	32.9	33.8	%

Notes:

¹ Measured in the CGH21240F-AMP amplifier circuit, under WCDMA 3GPP test model 1, 64 DPCH, 67% clipping, PAR = 8.81 dB @ 0.01% Probability on CCDF.

Features

- 1.8 - 2.3 GHz Operation
- 15 dB Gain
- -35 dBc ACLR at 40 W P_{AVE}
- 35% Efficiency at 40 W P_{AVE}
- High Degree of DPD Correction can be Applied

 Large Signal Models Available for ADS and MWO





Absolute Maximum Ratings (not simultaneous) at 25°C Case Temperature

Parameter	Symbol	Rating	Units	Conditions
Drain-Source Voltage	V_{DSS}	120	V	25°C
Gate-to-Source Voltage	V_{GS}	-10, +2		
Power Dissipation	P_{DISS}	115	W	
Storage Temperature	T_{STG}	-65, +150	°C	
Operating Junction Temperature	T_J	225		
Maximum Forward Gate Current	I_{GMAX}	60	mA	25°C
Maximum Drain Current ¹	I_{DMAX}	24		
Soldering Temperature ²	T_S	245	°C	
Screw Torque	τ	40	in-oz	
Thermal Resistance, Junction to Case ³	$R_{\theta JC}$	0.75	°C/W	85°C
Case Operating Temperature ³	T_C	-40, +150	°C	

Notes:

¹ Current limit for long term, reliable operation

² Refer to the Application Note on soldering at wolfspeed.com/rf/document-library

³ Measured for the CGH21240F at $P_{DISS} = 115$ W

Electrical Characteristics ($T_C = 25^\circ\text{C}$)

Characteristics	Symbol	Min.	Typ.	Max.	Units	Conditions
DC Characteristics¹						
Gate Threshold Voltage	$V_{GS(th)}$	-3.8	-3.0	-2.3	V_{DC}	$V_{DS} = 10$ V, $I_D = 57.6$ mA
Gate Quiescent Voltage	$V_{GS(Q)}$	—	-2.7	—		$V_{DS} = 28$ V, $I_D = 1.0$ A
Saturated Drain Current	I_{DS}	46.4	56.0	—	A	$V_{DS} = 6.0$ V, $V_{GS} = 2.0$ V
Drain-Source Breakdown Voltage	V_{BR}	84	—	—	V_{DC}	$V_{GS} = -8$ V, $I_D = 57.6$ mA
RF Characteristics^{2,3} ($T_C = 25^\circ\text{C}$, $F_0 = 2.14$ GHz unless otherwise noted)						
Saturated Output Power ^{3,4}	P_{SAT}	—	215	—	W	$V_{DD} = 28$ V, $I_{DQ} = 1.0$ A
Pulsed Drain Efficiency ³	η	—	65	—	%	$V_{DD} = 28$ V, $I_{DQ} = 1.0$ A, $P_{OUT} = P_{SAT}$
Modulated Gain ⁶	G_{SS}	13.5	15	—	dB	$V_{DD} = 28$ V, $I_{DQ} = 1.0$ A, $P_{OUT} = 46$ dBm
WCDMA Linearity ⁶	ACLR	—	-35	-30	dBc	
Modulated Drain Efficiency ⁶	η	27	33	—	%	
Output Mismatch Stress	VSWR	—	—	10 : 1	Ψ	No damage at all phase angles, $V_{DD} = 28$ V, $I_{DQ} = 1.0$ A, $P_{OUT} = 40$ W CW
Dynamic Characteristics						
Input Capacitance ⁷	C_{GS}	—	172	—	pF	$V_{DS} = 28$ V, $V_{GS} = -8$ V, $f = 1$ MHz
Output Capacitance ⁷	C_{DS}	—	19.5	—		
Feedback Capacitance	C_{GD}	—	3.2	—		

Notes:

¹ Measured on wafer prior to packaging

² Scaled from PCM data

³ Pulse Width = 40 μ s, Duty Cycle = 5%

⁴ P_{SAT} is defined as $I_G = 20$ mA peak

⁵ Measured in CGH21240F-AMP

⁶ Single Carrier WCDMA, 3GPP Test Model 1, 64 DPCH, 67 % Clipping, PAR = 8.81 dB @ 0.01% Probability on CCDF

⁷ Includes package and internal matching components



Typical Pulse Performance

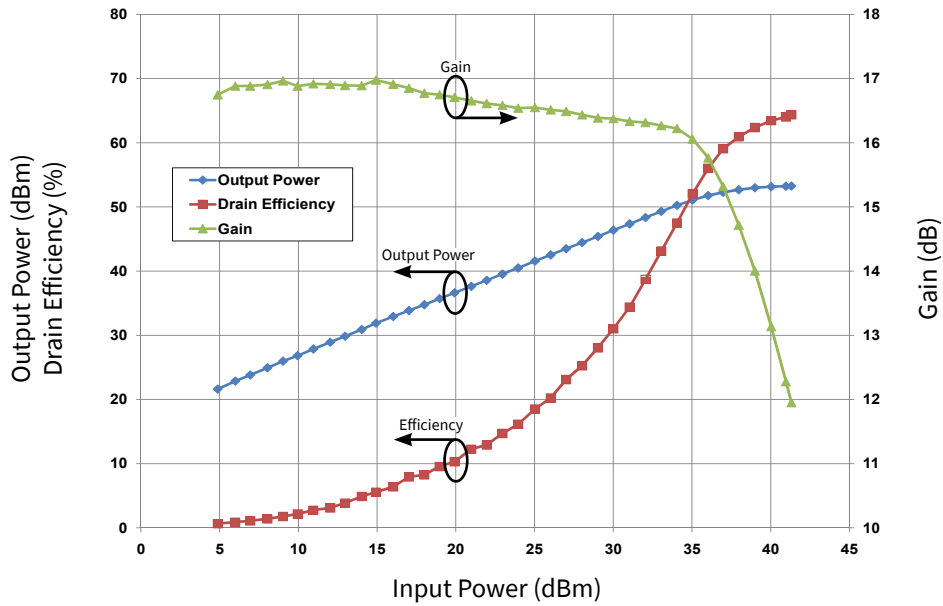

Figure 1. Typical Pulsed Output Power, Drain Efficiency, and Gain vs Input Power of the CGH21240F measured in CGH21240F-AMP Amplifier Circuit
 $V_{DS} = 28\text{ V}$, $I_{DS} = 1.0\text{ A}$, Freq = 2.14 GHz, Pulse Width = 40 μs , Duty Cycle = 5%

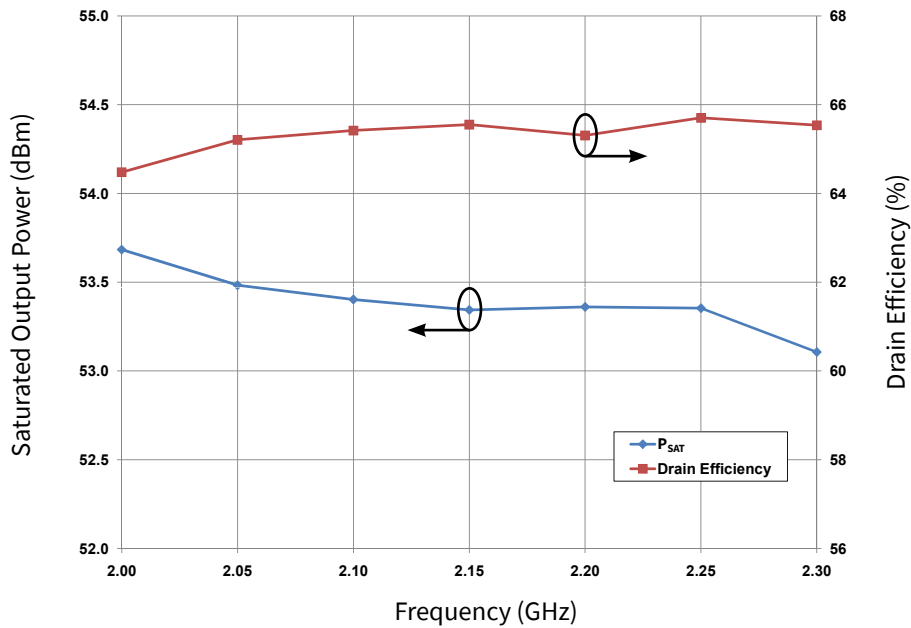

Figure 2. Typical Pulsed Saturated Power and Drain Efficiency vs Frequency of the CGH21240F measured in CGH21240F-AMP Amplifier Circuit.
 $V_{DS} = 28\text{ V}$, $I_{DS} = 1.0\text{ A}$, $P_{SAT} = 20\text{ mA } I_{GS}$ Peak, Pulse Width = 40 μs , Duty Cycle = 5 %



Typical Linear Performance

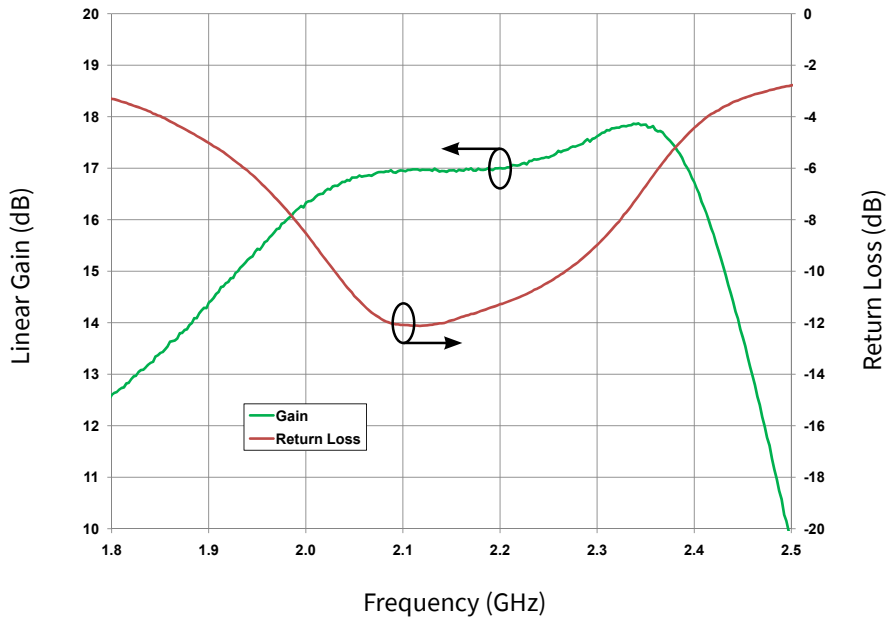

Figure 3. Typical Small Signal Gain and Return Loss vs Frequency of the CGH21240F measured in CGH21240F-AMP Amplifier Circuit
 $V_{DS} = 28\text{ V}$, $I_{DS} = 1.0\text{ A}$

Typical WCDMA Performance

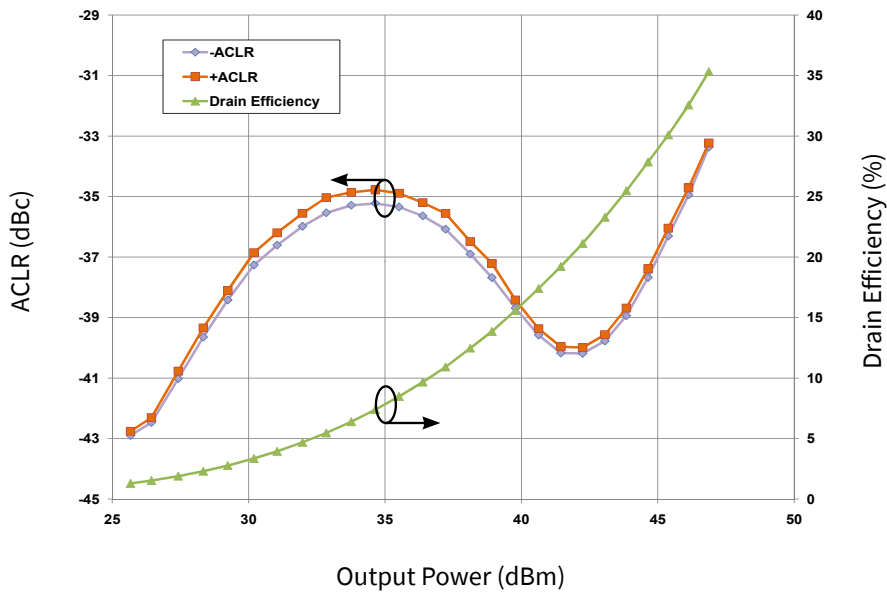

Figure 4. Typical WCDMA Characteristics ACLR and Drain Efficiency vs Output Power of the CGH21240F measured in CGH21240F-AMP Amplifier Circuit
 3GPP Test Model 1, 64 DPCH, 67% Clipping, 8.81 dB PAR @ 0.01%
 $V_{DS} = 28\text{ V}$, $I_{DS} = 1.0\text{ A}$, Frequency = 2.14 GHz



Typical WCDMA Digital Pre-Distortion (DPD) Performance

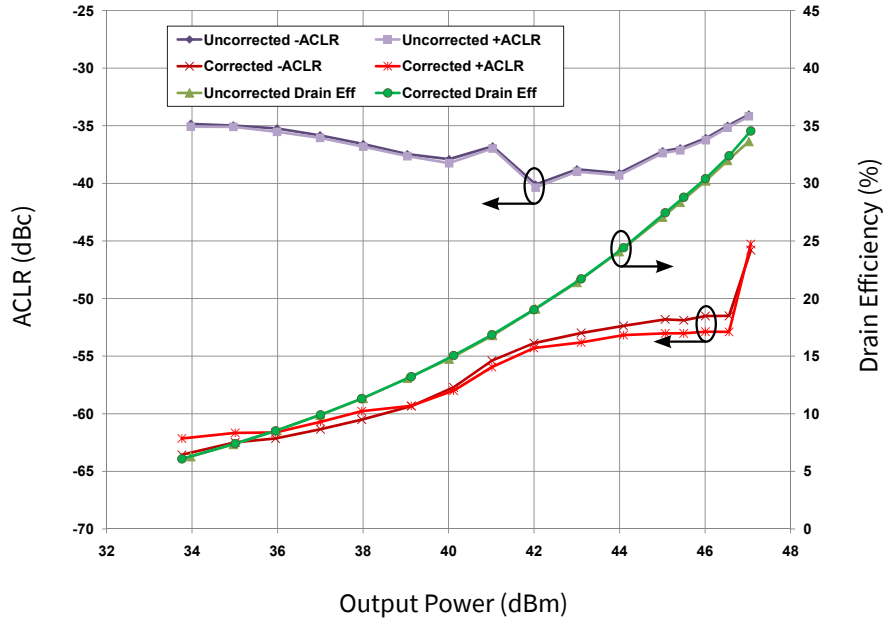

Figure 5. WCDMA Characteristics with and without DPD Correction ACLR and Drain Efficiency vs Output Power of the CGH21240F measured in CGH21240F-AMP Amplifier Circuit
 $V_{DS} = 28\text{ V}$, $I_{DS} = 1.0\text{ A}$, Frequency = 2.14 GHz

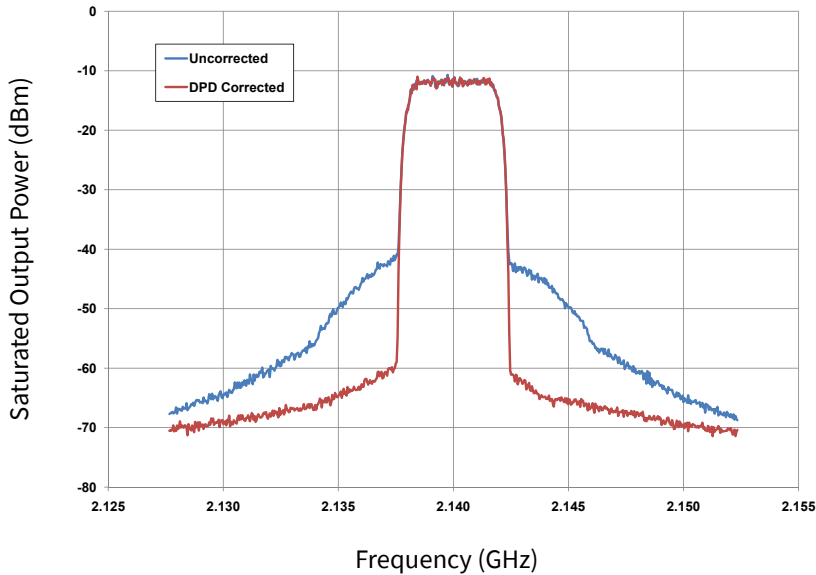

Figure 6. WCDMA Linearity with DPD Linearizer of the CGH21240F measured in CGH21240F-AMP Amplifier Circuit Single Channel WCDMA 6.5dB PAR with CFR
 $V_{DS} = 28\text{ V}$, $I_{DS} = 1.0\text{ A}$, $P_{AVE} = 46\text{ dBm}$, Efficiency = 30%



Typical Performance

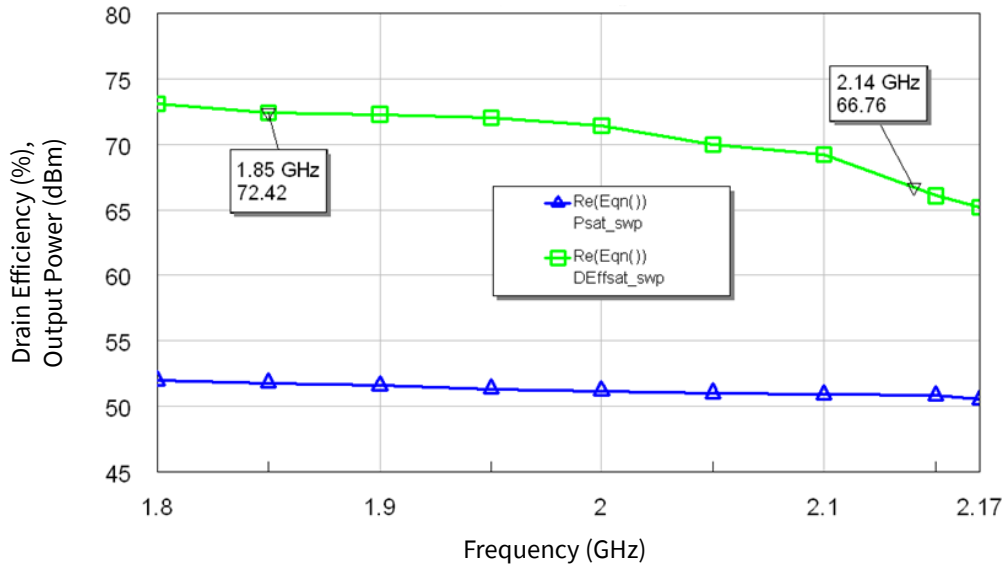
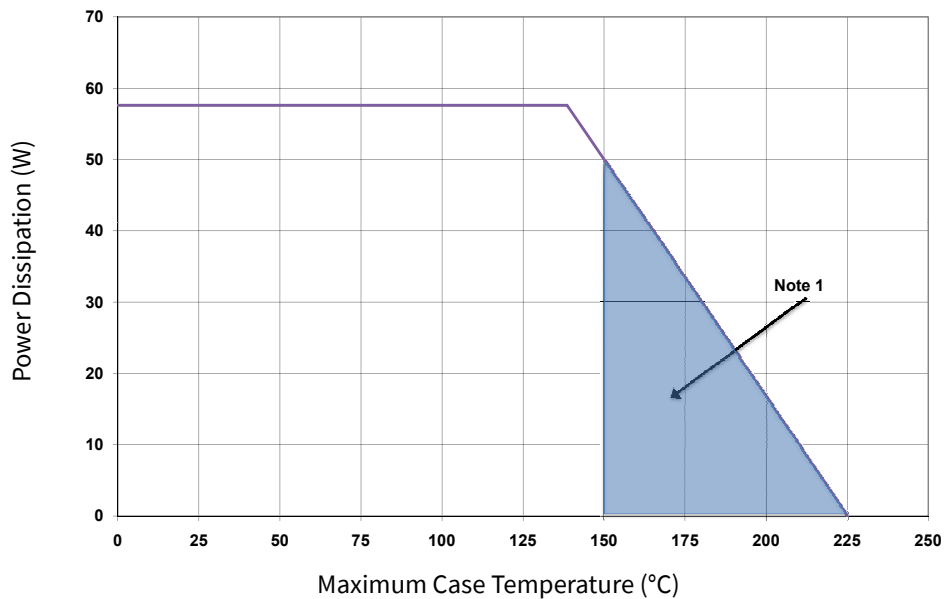

Figure 7. Simulated Performance of the CGH21240F from 1.8 - 2.17 GHz
 $V_{DD} = 28\text{ V}$, $I_{DQ} = 1.0\text{ A}$

CGH21240F Power Dissipation De-rating Curve



Note:
¹ Area exceeds Maximum Case Operating Temperature (See Page 2)



Typical Performance

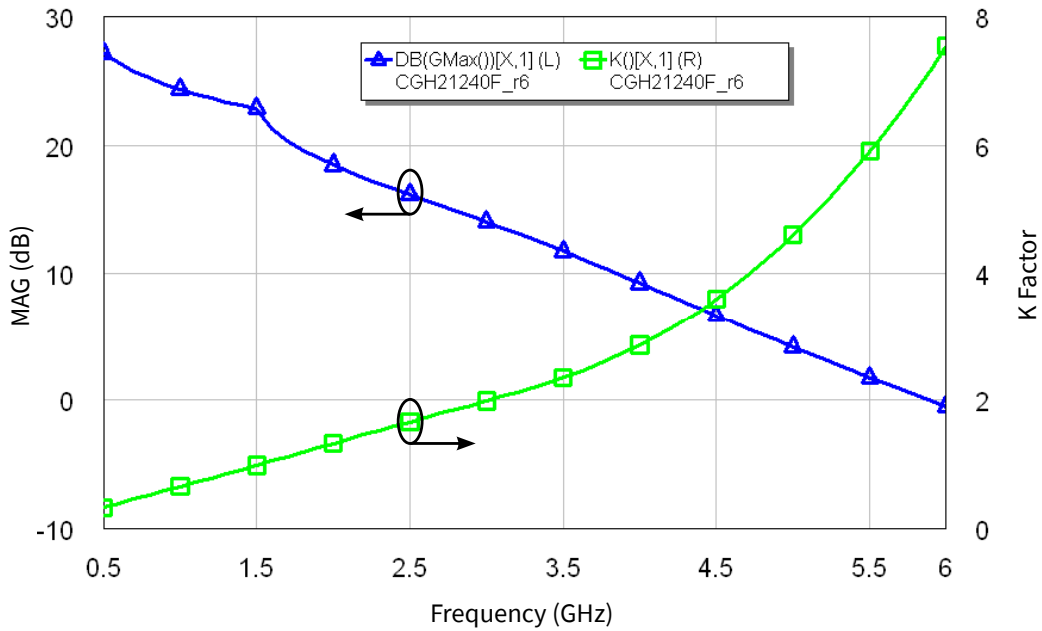

Figure 8. Simulated Maximum Available Gain and K Factor of the CGH21240F
 $V_{DD} = 28\text{ V}$, $I_{DQ} = 1.0\text{ A}$

Typical Noise Performance

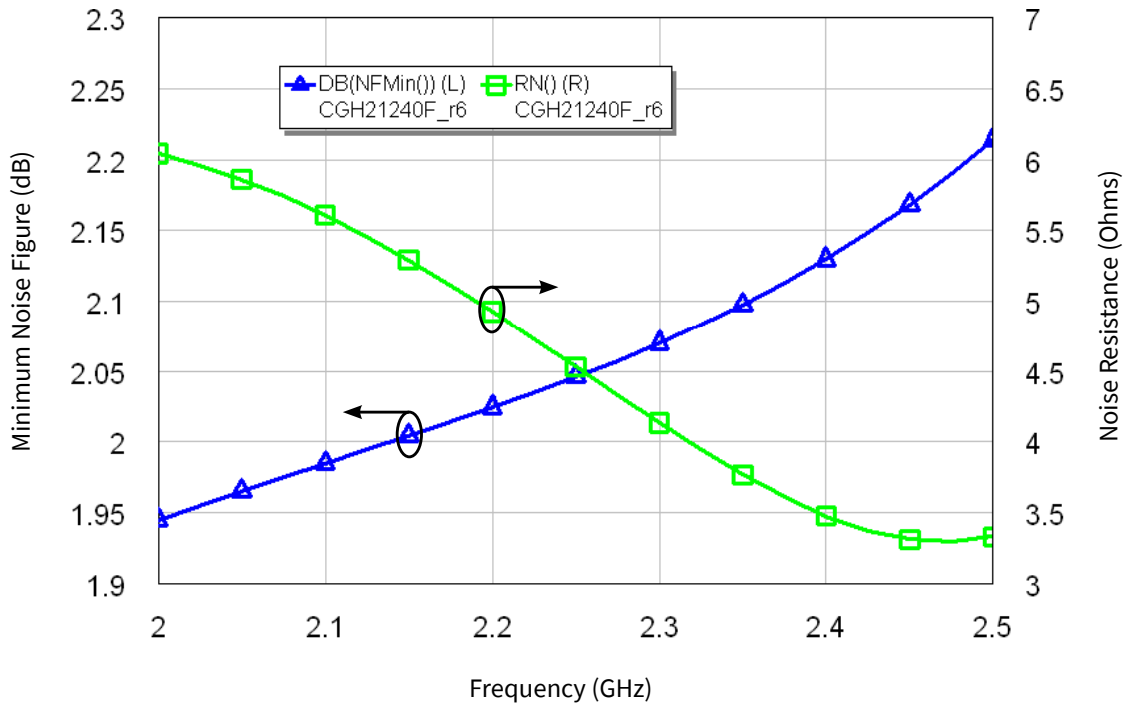
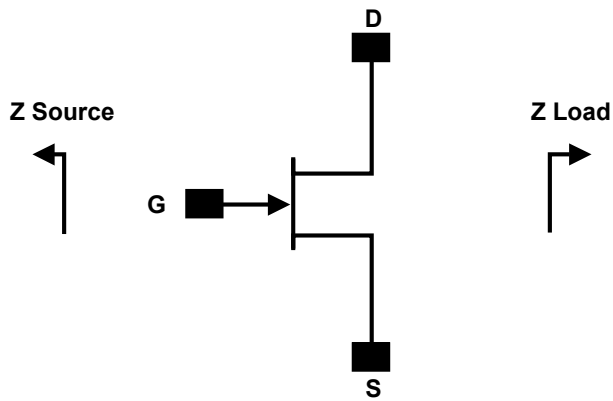

Figure 9. Simulated Minimum Noise Figure and Noise Resistance vs Frequency of the CGH21240F
 $V_{DD} = 28\text{ V}$, $I_{DQ} = 1.0\text{ A}$



Source and Load Impedances



Frequency (MHz)	Z Source	Z Load
1900	4.50 - j 4.36	2.98 - j 0.69
1950	4.28 - j 4.23	3.17 - j 0.88
2000	4.05 - j 4.04	3.20 - j 1.22
2050	3.86 - j 3.82	2.98 - j 1.60
2100	3.69 - j 3.58	2.52 - j 1.85
2150	3.55 - j 3.32	1.95 - j 1.85
2200	3.44 - j 3.04	1.42 - j 1.63
2250	3.36 - j 2.76	1.00 - j 1.28
2300	3.30 - j 2.47	0.70 - j 0.86

Notes:

¹ $V_{DD} = 28\text{ V}$, $I_{DQ} = 250\text{ mA}$ in the 440117 package

² Impedances are extracted from CGH21240F-AMP demonstration circuit and are not source and load pull data derived from the transistor

Electrostatic Discharge (ESD) Classifications

Parameter	Symbol	Class	Classification Level	Test Methodology
Human Body Model	HBM	TBD	ANSI/ESDA/JEDEC JS-001 Table 3	JEDEC JESD22 A114-D
Charge Device Model	CDM	TBD	ANSI/ESDA/JEDEC JS-002 Table 3	JEDEC JESD22 C101-C



CGH21240F-AMP Demonstration Amplifier Circuit Bill of Materials

Designator	Description	Qty
R1	RES, 1/16W, 0603, 1%, 100 OHMS	1
R2	RES, 1/16W, 0603, 1%, 5.1 OHMS	1
C1	CAP, 27pF, +/-5%, ATC600S	1
C2	CAP, 2.0pF, +/-0.1pF, ATC600S	1
C3	CAP, 10pF, +/-5%, ATC600S	1
C4, C10	CAP, 470pF, +/-5%, 100V, 0603	2
C5, C11, C16	CAP, 33000pF, 0805, 100V, X7R	3
C6, C12, C17	CAP, 1.0μF, +/-10%, 1210, 100V, X7R	3
C7	CAP, 10μF, 16V, TANTALUM	1
C8, C14	CAP, 2.0pF, +/-0.1pF, 250V, 0805, ATC600F	2
C9, C15	CAP, 10pF, +/-0.1pF, 250V, 0805, ATC600F	2
C13	CAP 100μF, 160V, ELECTROLYTIC	1
C18	CAP, 33μF, +/-20%, G CASE	1
C19, C20	CAP, 39pF, +/-5%, 250V, 0805, ATC600F	2
J1, J2	CONN, N-Type, Female, 0.500 SMA Flange	2
J3	CONN, Header, RT> PLZ, 0.1 CEN, LK, 9 POS	1
—	PCB, RO4350, Er = 3.48, h = 20 mil	1
—	CGH21240F	1

CGH21240F-AMP Demonstration Amplifier Circuit

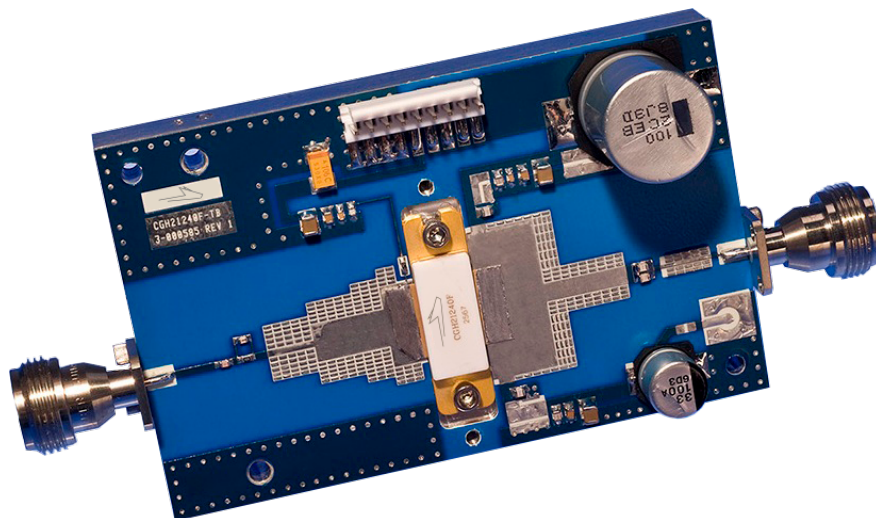



CGH21240F-AMP Demonstration Amplifier Circuit Schematic

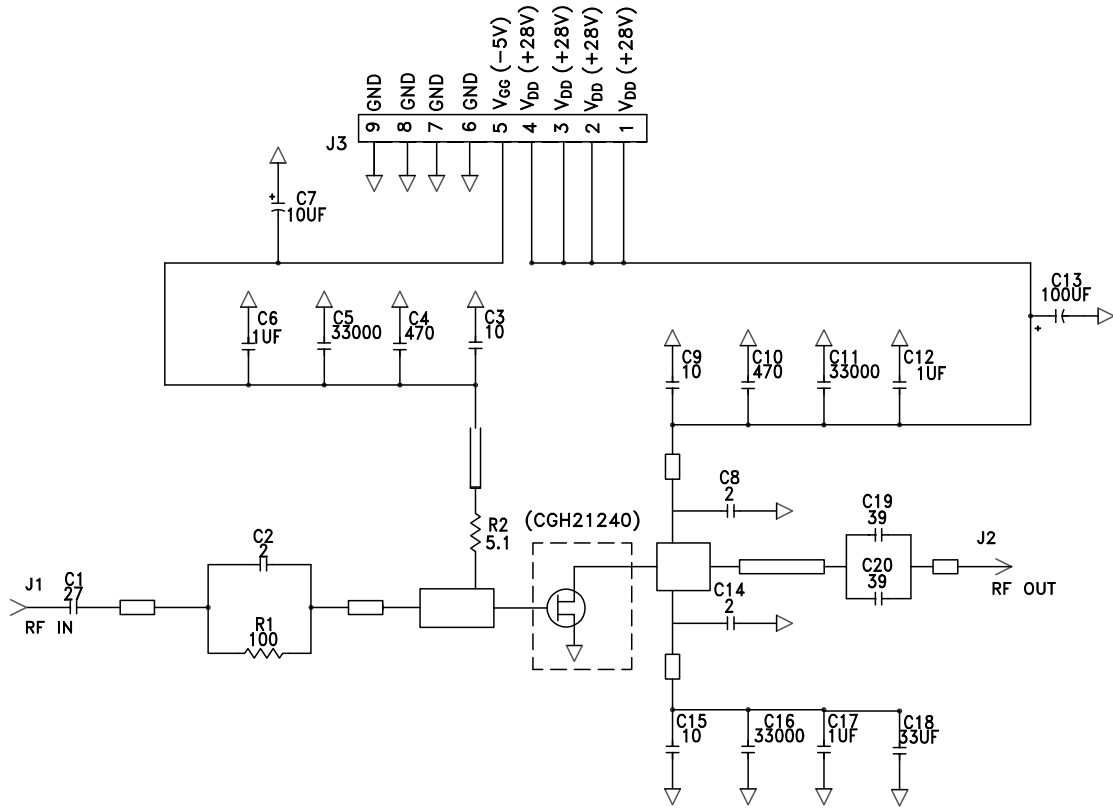

CGH21240F-AMP Demonstration Amplifier Circuit Outline

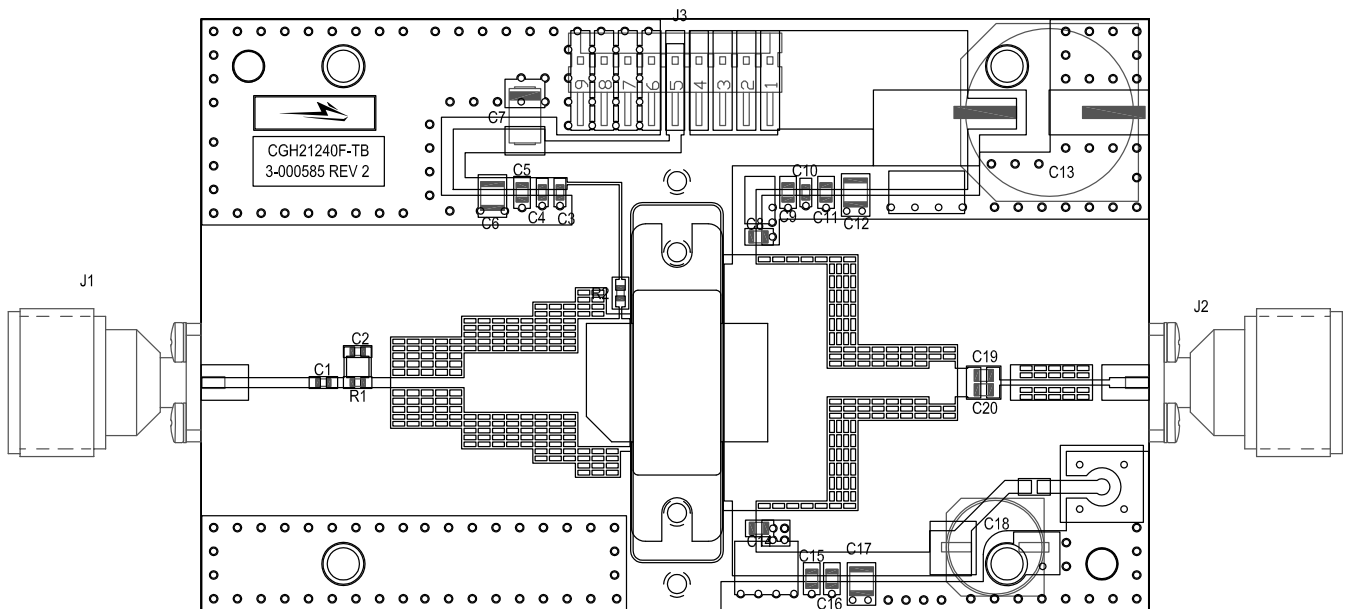



Typical Package S-Parameters for CGH21240F
 (Small Signal, $V_{DS} = 28\text{ V}$, $I_{DQ} = 1.0\text{ A}$, angle in degrees)

Frequency	Mag S11	Ang S11	Mag S21	Ang S21	Mag S12	Ang S12	Mag S22	Ang S22
500 MHz	0.983	179.25	1.84	66.59	0.004	-13.75	0.823	-177.25
600 MHz	0.983	178.45	1.56	61.58	0.004	-16.73	0.828	-176.89
700 MHz	0.982	177.73	1.36	56.57	0.004	-19.66	0.834	-176.58
800 MHz	0.981	177.04	1.22	51.54	0.004	-22.56	0.841	-176.31
900 MHz	0.980	176.38	1.12	46.42	0.004	-25.48	0.848	-176.07
1.0 GHz	0.978	175.72	1.04	41.17	0.004	-28.46	0.855	-175.87
1.1 GHz	0.976	175.07	0.99	35.70	0.004	-31.57	0.862	-175.71
1.2 GHz	0.974	174.42	0.95	29.94	0.004	-34.88	0.870	-175.56
1.3 GHz	0.970	173.77	0.93	23.76	0.004	-38.51	0.879	-175.44
1.4 GHz	0.966	173.13	0.92	16.98	0.005	-42.62	0.888	-175.35
1.5 GHz	0.961	172.51	0.92	9.40	0.005	-47.40	0.898	-175.28
1.6 GHz	0.954	171.95	0.93	0.77	0.005	-53.11	0.910	-175.28
1.7 GHz	0.947	171.50	0.94	-9.23	0.005	-60.04	0.925	-175.39
1.8 GHz	0.939	171.24	0.95	-20.82	0.006	-68.42	0.941	-175.71
1.9 GHz	0.933	171.20	0.94	-34.02	0.006	-78.25	0.957	-176.32
2.0 GHz	0.931	171.32	0.90	-48.37	0.006	-89.09	0.971	-177.25
2.1 GHz	0.935	171.39	0.83	-62.95	0.006	-100.00	0.979	-178.39
2.2 GHz	0.944	171.20	0.74	-76.66	0.005	-109.90	0.981	-179.50
2.3 GHz	0.954	170.68	0.64	-88.79	0.005	-118.09	0.979	-179.57
2.4 GHz	0.963	169.89	0.54	-99.14	0.004	-124.40	0.974	-178.85
2.5 GHz	0.971	168.91	0.46	-107.87	0.004	-128.98	0.970	-178.30
2.6 GHz	0.976	167.81	0.40	-115.25	0.003	-132.17	0.966	-177.87
2.7 GHz	0.981	166.63	0.34	-121.56	0.003	-134.27	0.963	-177.52
2.8 GHz	0.984	165.35	0.30	-127.07	0.003	-135.56	0.960	-177.20
2.9 GHz	0.986	164.00	0.26	-131.94	0.003	-136.27	0.959	-176.90
3.0 GHz	0.988	162.54	0.24	-136.34	0.003	-136.57	0.957	-176.61
3.2 GHz	0.990	159.26	0.19	-144.13	0.002	-136.53	0.956	-176.02
3.4 GHz	0.991	155.29	0.17	-151.15	0.002	-136.31	0.955	-175.41
3.6 GHz	0.991	150.30	0.15	-157.91	0.002	-136.53	0.955	-174.76
3.8 GHz	0.990	143.73	0.14	-164.89	0.003	-137.70	0.954	-174.06
4.0 GHz	0.988	134.60	0.13	-172.75	0.003	-140.42	0.954	-173.32
4.2 GHz	0.985	121.09	0.14	177.52	0.003	-145.66	0.953	-172.52
4.4 GHz	0.978	99.57	0.15	164.06	0.004	-155.19	0.952	-171.66
4.6 GHz	0.968	63.52	0.16	143.65	0.005	-172.15	0.951	-170.72
4.8 GHz	0.961	8.37	0.16	114.18	0.006	161.39	0.949	-169.70
5.0 GHz	0.971	-49.39	0.13	83.48	0.005	133.32	0.947	-168.55
5.2 GHz	0.984	-89.09	0.09	61.46	0.004	113.61	0.943	-167.26
5.4 GHz	0.991	-112.76	0.06	47.31	0.003	101.50	0.939	-165.81
5.6 GHz	0.995	-127.38	0.04	37.64	0.003	93.61	0.933	-164.16
5.8 GHz	0.996	-137.07	0.03	30.34	0.002	87.89	0.926	-162.23
6.0 GHz	0.998	-143.91	0.03	24.30	0.002	83.22	0.916	-159.94

To download the s-parameters in s2p format, go to the [CGH21240F Product page](#) and click on the documentation tab.



Product Dimensions CGH21240F (Package Type — 440117)

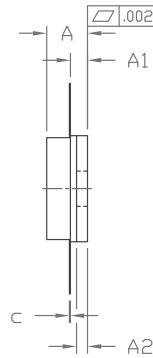
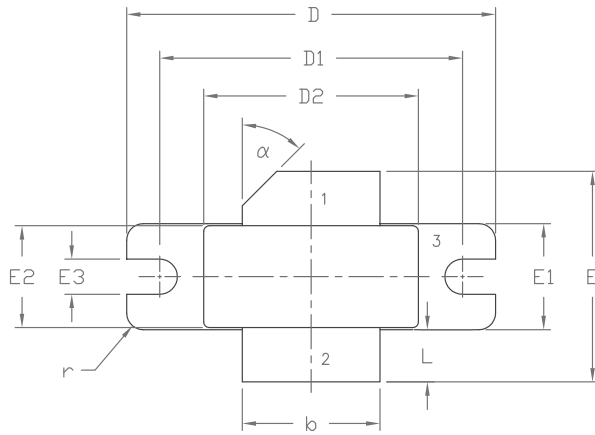

PIN 1. GATE
 2. DRAIN
 3. SOURCE

NOTES:

1. DIMENSIONING AND TOLERANCING PER ANSI Y14.5M - 1994.
2. CONTROLLING DIMENSION: INCH.
3. ADHESIVE FROM LID MAY EXTEND A MAXIMUM OF 0.020" BEYOND EDGE OF LID.
4. LID MAY BE MISALIGNED TO THE BODY OF PACKAGE BY A MAXIMUM OF 0.008" IN ANY DIRECTION.

DIM	INCHES		MILLIMETERS		NOTES
	MIN	MAX	MIN	MAX	
A	0.138	0.158	3.51	4.01	
A1	0.057	0.067	1.45	1.70	
A2	0.035	0.045	0.89	1.14	
b	0.495	0.505	12.57	12.83	2x
c	0.003	0.006	0.08	0.15	
D	1.335	1.345	33.91	34.16	
D1	1.095	1.105	27.81	28.07	
D2	0.773	0.787	19.63	20.00	
E	0.745	0.785	18.92	19.94	
E1	0.380	0.390	9.65	9.91	
E2	0.365	0.375	9.72	9.53	
E3	0.123	0.133	3.12	3.38	
L	0.170	0.210	4.32	5.33	2x
r	0.06	TYP	0.06	TYP	4x
α	45°	REF	45°	REF	

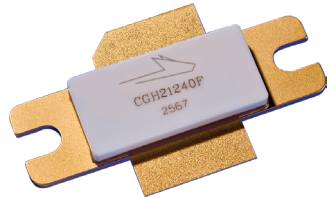
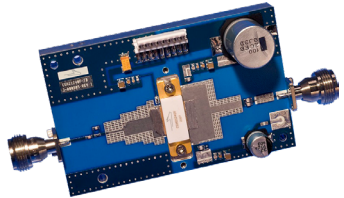

Product Ordering Information

Order Number	Description	Unit of Measure	Image
CGH21240F	GaN HEMT	Each	 A small, rectangular GaN HEMT component with a white ceramic body and gold-colored metal leads. The top surface is marked with the Wolfstreak logo and the text "CGH21240F" and "2567".
CGH21240F-AMP	Test board with GaN HEMT installed	Each	 A blue printed circuit board (PCB) test board with various electronic components, including a central GaN HEMT component, capacitors, and connectors. It has two SMA connectors on the right side.

**For more information, please contact:**

4600 Silicon Drive
Durham, NC 27703 USA
Tel: +1.919.313.5300
www.wolfspeed.com/RF

Sales Contact
RFSales@wolfspeed.com

RF Product Marketing Contact
RFMarketing@wolfspeed.com

Notes & Disclaimer

Specifications are subject to change without notice. “Typical” parameters are the average values expected by Wolfspeed in large quantities and are provided for information purposes only. Wolfspeed products are not warranted or authorized for use as critical components in medical, life-saving, or life-sustaining applications, or other applications where a failure would reasonably be expected to cause severe personal injury or death. No responsibility is assumed by Wolfspeed for any infringement of patents or other rights of third parties which may result from use of the information contained herein. No license is granted by implication or otherwise under any patent or patent rights of Wolfspeed.

© 2009-2022 Wolfspeed, Inc. All rights reserved. Wolfspeed® and the Wolfstreak logo are registered trademarks and the Wolfspeed logo is a trademark of Wolfspeed, Inc.
PATENT: <https://www.wolfspeed.com/legal/patents>

The information in this document is subject to change without notice.