

- **Low-loss UHF SAW Filter**
- **3.0 x 3.0 Surface-mount Package**
- **Complies with Directive 2002/95/EC (RoHS)**

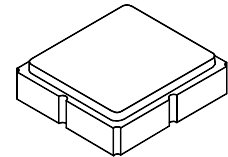

SF2249E

**1602 MHz
SAW Filter**



SM3030-8

Maximum Rating

Rating	Value	Units
Input Power Level	+10	dBm
DC Voltage on any Non-ground Terminal	3	V
Operating Temperature Range	-40 to +85	°C
Storage Temperature Range in Tape and Reel	-40 to +85	°C
Solder Reflow Temperature, 10 seconds/5 cycles maximum	260	°C

Characteristic	Sym	Note	Min	Typ	Max	Units
Center Frequency	f_c			1602		MHz
3 dB Bandwidth	BW_3			61		
Insertion Loss, 1596 to 1607 MHz	IL			3.0	4.0	dB
Amplitude Ripple, 1596 to 1607 MHz				0.6	2.0	
Group Delay Ripple, 1596 to 1607 MHz				6	15	ns
Input/Output Return Loss, 1596 to 1607 MHz			8	9		dB
Attenuation, 0 dB Reference:						dB
10 to 1500 MHz			45	48		
1700 to 2400 MHz			43	50		
200 ohm Balanced Source Impedance				200 Ω 18 nH		
200 ohm Balanced Load Impedance				200 Ω 18 nH		

Case Style	SM3030-8 3.0 x 3.0 mm Nominal Footprint					
Lid Symbolization, Y=year, WW=week, S=shift, dot=pin 1 indicator	990, YWWWS					
Standard Reel Quantity	Reel Size 7 inch					500 Pieces/Reel
	Reel Size 13 inch					3000 Pieces/Reel

Electrical Connections

Connection	Terminals
Input	1, 2
Balanced Output	5, 6
Case Ground	All others

CAUTION: Electrostatic Sensitive Device. Observe precautions for handling.

NOTES:

1. The design, manufacturing process, and specifications of this device are subject to change.
2. US or International patents may apply.

Filter Response Plots

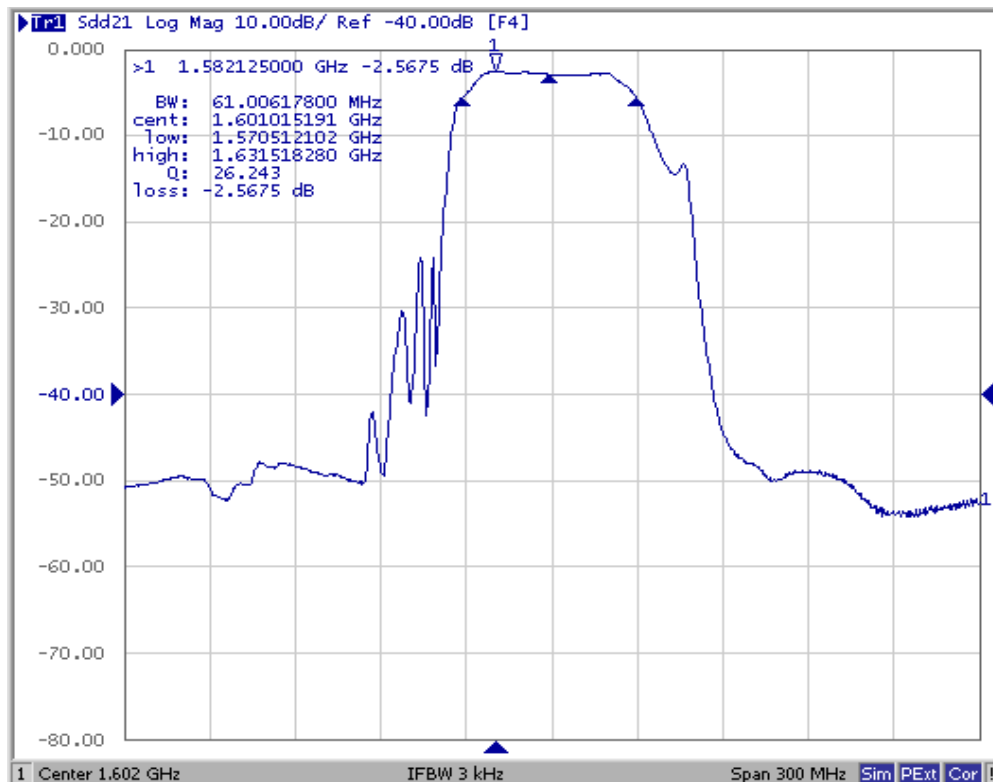
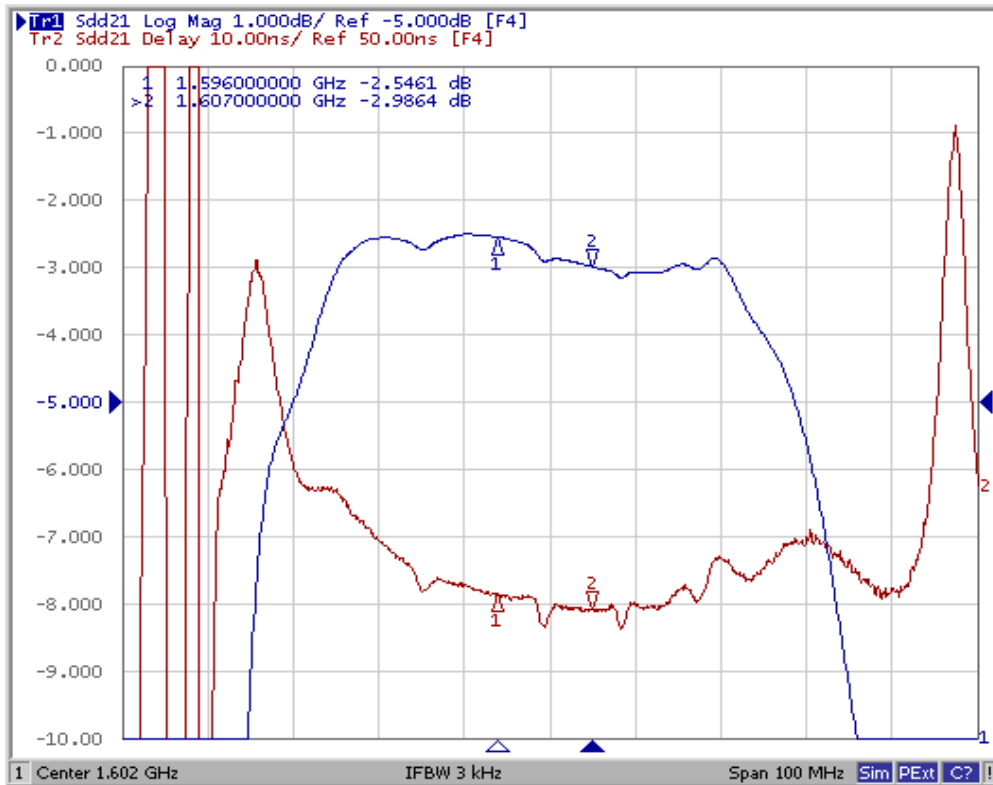

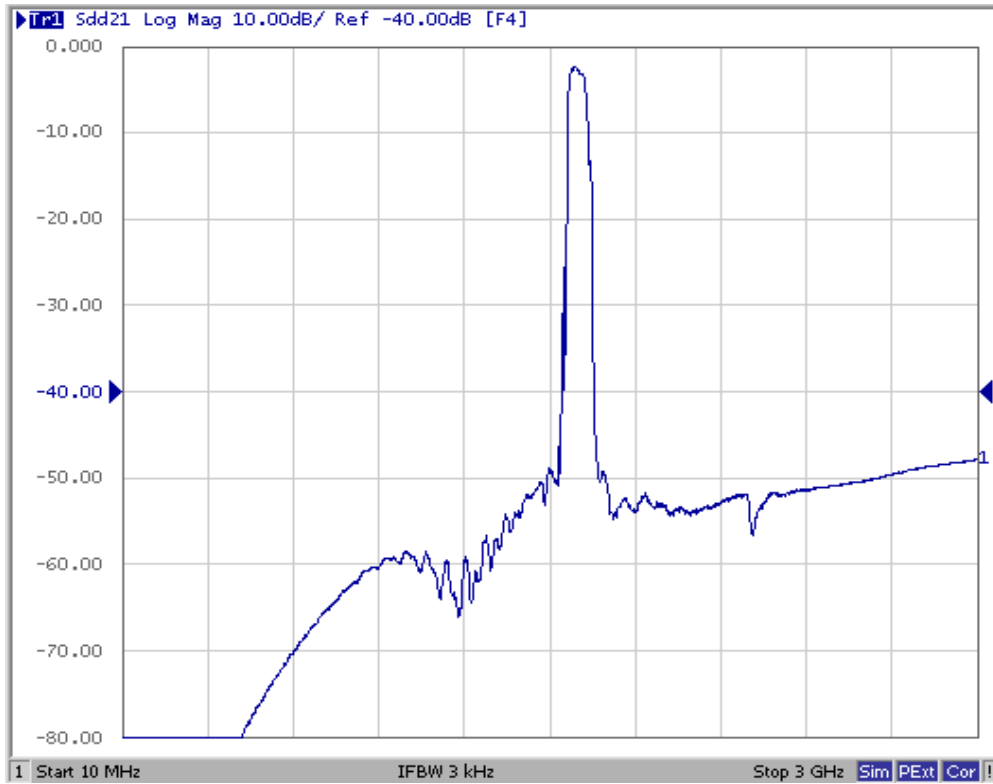

Input/Output Return Loss Plots

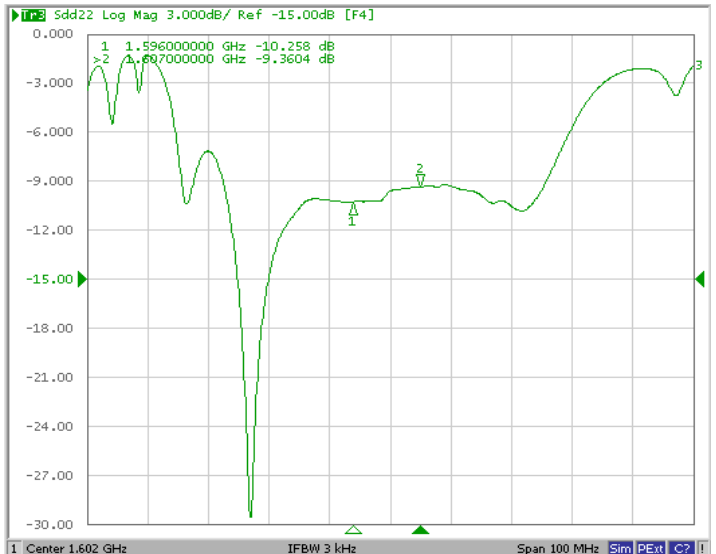
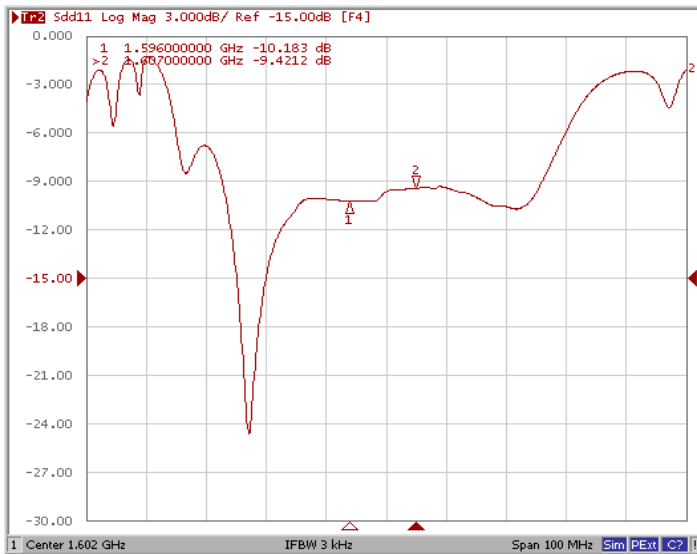

8-Terminal Ceramic Surface-Mount Case 3.0 X 3.0 mm Nominal Footprint

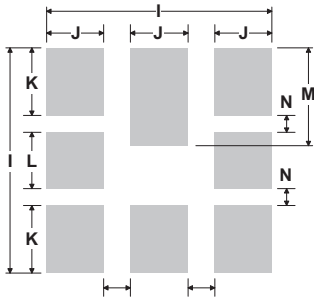
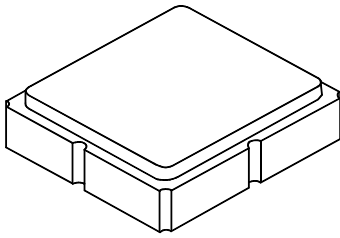

PCB Footprint Top View

Case and PCB Footprint Dimensions

Dimension	mm			Inches		
	Min	Nom	Max	Min	Nom	Max
A	2.87	3.00	3.13	0.113	0.118	0.123
B	2.87	3.00	3.13	0.113	0.118	0.123
C	-	-	1.10	-	-	0.043
D	0.79	0.92	1.05	0.031	0.036	0.041
E	0.62	0.75	0.88	0.024	0.029	0.034
F	0.47	0.60	0.73	0.018	0.024	0.029
G	0.47	0.60	0.73	0.018	0.024	0.029
H	1.07	1.20	1.33	0.042	0.047	0.052
I		3.19			0.126	
J		0.81			0.032	
K		0.96			0.038	
L		0.81			0.032	
M		1.39			0.055	
N		0.23			0.009	
O		0.38			0.015	

Case Materials

Materials	
Solder Pad Plating	0.3 to 1.0 μm Gold over 1.27 to 8.89 μm Nickel
Lid Plating	2.0 to 3.0 μm Nickel
Body	Al_2O_3 Ceramic
	Pb Free

TOP VIEW

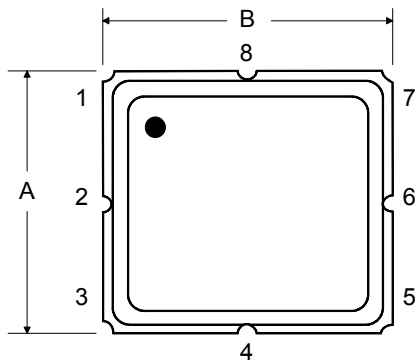

BOTTOM VIEW

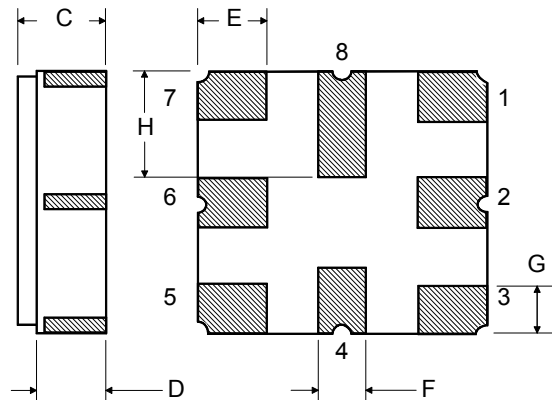

Tape and Reel Specifications

Tape and Reel Standard per ANSI/EIA-481

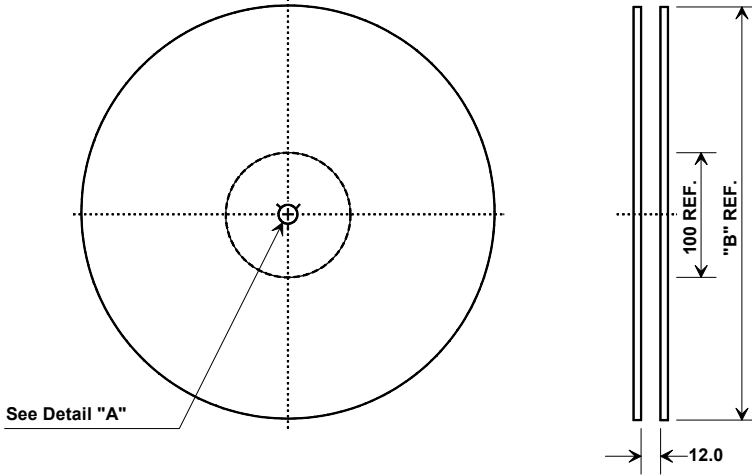

"B" Nominal Size		Quantity Per Reel
Inches	millimeters	
7	178	500
13	330	3000

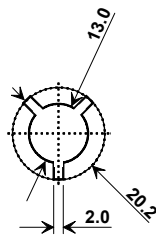

Carrier Tape Dimensions	
Ao	3.35 mm
Bo	3.35 mm
Ko	1.4 mm
Pitch	8.0 mm
W	12.0 mm

COMPONENT ORIENTATION and DIMENSIONS

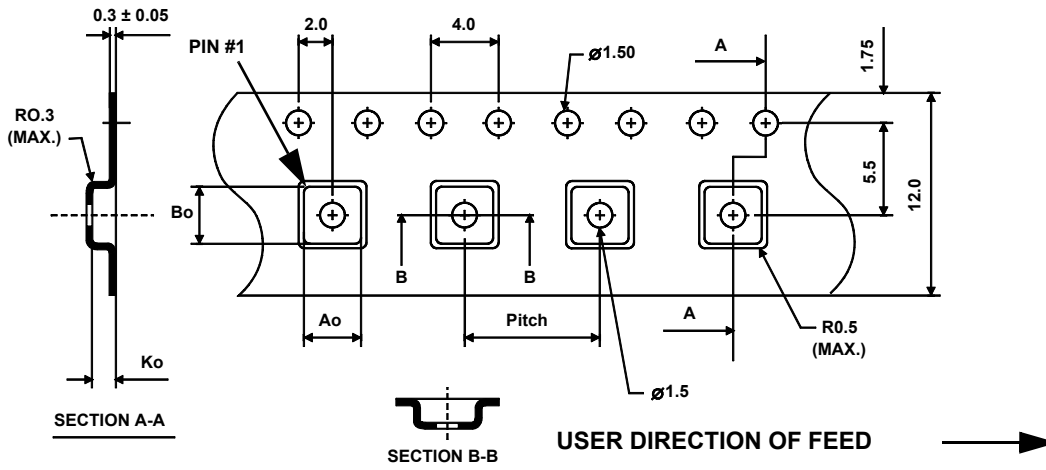

Recommended Reflow Profile

1. Preheating shall be fixed at 150~180°C for 60~90 seconds.
2. Ascending time to preheating temperature 150°C shall be 30 seconds min.
3. Heating shall be fixed at 220°C for 50~80 seconds and at 260°C +0/-5°C peak (10 seconds).
4. Time: 5 times maximum.

