

CAM-M8

u-blox M8 Concurrent GNSS Antenna Modules Hardware Integration Manual



Abstract

This document describes the hardware features and specifications of the CAM-M8 chip antenna modules, which feature the u-blox M8 concurrent GNSS engine with reception of GPS, GLONASS, BeiDou, Galileo and QZSS signals.

Document Information

Title	CAM-M8	
Subtitle	u-blox M8 Concurrent GNSS Antenna Modules	
Document type	Hardware Integration Manual	
Document number	UBX-15030063	
Revision and date	R04	7-Feb-2019
Document status	Production Information	

Product status	Corresponding content status	
In Development / Prototype	Objective Specification	Target values. Revised and supplementary data will be published later.
Engineering Sample	Advance Information	Data based on early testing. Revised and supplementary data will be published later.
Initial Production	Early Production Information	Data from product verification. Revised and supplementary data may be published later.
Mass Production / End of Life	Production Information	Document contains the final product specification.

European Union regulatory compliance

CAM-M8C and CAM-M8Q comply with all relevant requirements for RED 2014/53/EU. The CAM-M8 C/Q Declaration of Conformity (DoC) is available at www.u-blox.com within Support > Product resources > Conformity Declaration.

This document applies to the following products:

Product name	Type number	Firmware version	PCN reference
CAM-M8C	CAM-M8C-0-10	ROM SPG 3.01	UBX-16016365
CAM-M8Q	CAM-M8Q-0-10	ROM SPG 3.01	UBX-16016365

u-blox or third parties may hold intellectual property rights in the products, names, logos and designs included in this document. Copying, reproduction, modification or disclosure to third parties of this document or any part thereof is only permitted with the express written permission of u-blox.

The information contained herein is provided "as is" and u-blox assumes no liability for its use. No warranty, either express or implied, is given, including but not limited to, with respect to the accuracy, correctness, reliability and fitness for a particular purpose of the information. This document may be revised by u-blox at any time without notice. For the most recent documents, visit www.u-blox.com.

Copyright © u-blox AG.

Contents

Document Information	2
Contents	3
1 Hardware description	4
1.1 Overview	4
1.2 Configuration	4
1.3 Connecting power	4
1.4 Interfaces.....	5
1.4.1 UART	5
1.4.2 Display Data Channel (DDC)	5
1.4.3 TX_READY	6
1.5 I/O pins.....	6
1.5.1 RESET_N: Reset.....	6
1.5.2 EXTINT: External interrupt	6
1.5.3 TIMEPULSE.....	6
1.5.4 SAFEBOOT_N.....	7
1.5.5 D_SEL: Interface select	7
1.5.6 LNA_EN: LNA enable.....	7
1.6 Electromagnetic interference on I/O lines	7
2 Design	8
2.1 Pin description	8
2.1.1 Pin name changes.....	9
2.2 Minimal design.....	9
2.3 Suggested pad layout	10
2.4 Antenna.....	10
2.5 Embedded antenna operation.....	12
2.6 PCB layout suggestion	13
3 Product handling	17
3.1 Packaging, shipping, storage and moisture preconditioning	17
3.2 Soldering	17
3.3 EOS/ESD/EMI precautions.....	20
3.3.1 Electromagnetic interference (EMI)	22
3.4 Applications with cellular modules.....	23
Appendix	25
A Glossary	25
B Recommended parts	25
Related documents	27
Revision history	27
Contact	28

1 Hardware description

1.1 Overview

The CAM-M8 modules are concurrent GNSS chipantenna modules featuring the high performance u-blox M8 concurrent GNSS engine with reception of GPS, GLONASS, BeiDou, Galileo and QZSS signals. Available in an industry standard form factor in leadless chip carrier (LCC) packages, it is easy to integrate and combines exceptional positioning performance with highly flexible power, design, and connectivity options. SMT pads allow fully automated assembly with standard pick & place and reflow-soldering equipment for cost-efficient, high-volume production enabling short time-to-market.

 For product features see the *CAM-M8 Data Sheet* [1].

 To determine which u-blox product best meets your needs, see the product selector tables on the u-blox website (www.u-blox.com).

1.2 Configuration

The configuration settings can be modified using UBX protocol configuration messages; see the *u-blox 8 / u-blox^{M8} Receiver Description Including Protocol Specification* [2]. The modified settings remain effective until power-down or reset. If these settings have been stored in BBR (Battery Backed RAM), then the modified configuration will be retained, as long as the backup battery supply is not interrupted.

1.3 Connecting power

CAM-M8 antenna modules have three power supply pins: **VCC**, **V_BCKP**, **VCC_IO**.

VCC: Main supply voltage

The **VCC** pin provides the main supply voltage. During operation, the current drawn by the module can vary by some orders of magnitude, especially if enabling low-power operation modes. For this reason, it is important that the supply circuitry be able to support the peak power for a short time (see the *CAM-M8 Data Sheet* [1] for specification).

 When switching from backup mode to normal operation or at start-up, CAM-M8 antenna modules must charge their internal capacitors in the core domain. In certain situations, this can result in a significant current draw. For low power applications using Power Save and backup modes, it is important that the power supply or low ESR capacitors at the module input can deliver this current/charge.

 Use a proper GND concept. Do not use any resistors or coils in the power line.

V_BCKP: Backup supply voltage

In case of a power failure on the module supply, **V_BCKP** supplies the real-time clock (RTC) and battery backed RAM (BBR). Use of valid time and the GNSS orbit data at start-up will improve the GNSS performance, i.e. hot starts and warm starts. If no backup battery is connected, the module performs a cold start at power-up.

- Avoid high resistance on the **V_BCKP** line: During the switch from main supply to backup supply, a short current adjustment peak can cause high voltage drop on the pin with possible malfunctions.
- If no backup supply voltage is available, connect the **V_BCKP** pin to **VCC**.
- As long as **VCC** supplies the CAM-M8 antenna module, the backup battery is disconnected from the RTC and the BBR to avoid unnecessary battery drain (see Figure 1). In this case, **VCC** supplies power to the RTC and BBR.

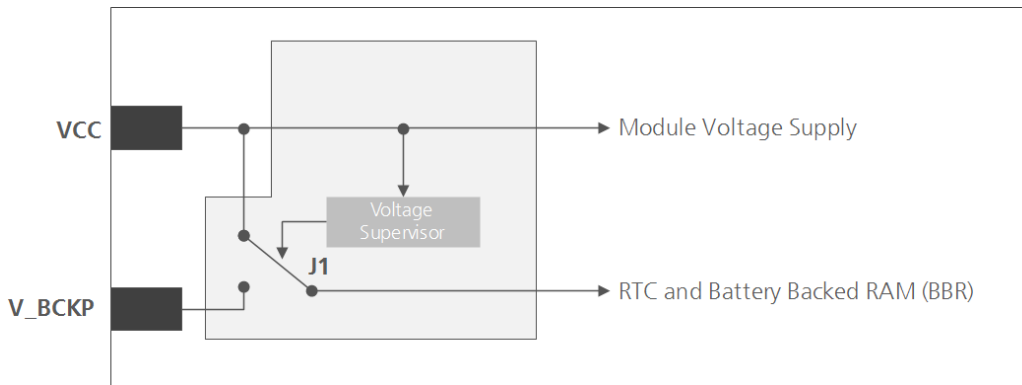

Figure 1: Backup battery and voltage

VCC_IO: IO supply voltage

VCC_IO from the host system supplies the digital I/Os. The wide range of **VCC_IO** allows seamless interfacing to standard logic voltage levels independent of the **VCC** voltage level. In many applications, **VCC_IO** is simply connected to the main supply voltage.

- Without a **VCC_IO** supply, the system will remain in reset state.

1.4 Interfaces

1.4.1 UART

CAM-M8 antenna modules include a Universal Asynchronous Receiver Transmitter (UART) serial interface, **RXD/TXD**, which supports configurable baud rates, as specified in the *CAM-M8 Data Sheet* [1]. The signal output and input level is 0 V to **VCC**. An interface based on RS232 standard levels (+/- 12 V) can be implemented using level shifters, such as Maxim MAX3232. Hardware handshake signals and synchronous operation are not supported.

1.4.2 Display Data Channel (DDC)

An I²C compatible Display Data Channel (DDC) interface is available with CAM-M8 antenna modules for serial communication with an external host CPU. The interface only supports operation in slave mode (master mode is not supported). The DDC protocol and electrical interface are fully compatible with the Fast-Mode of the I²C industry standard. DDC pins **SDA** and **SCL** have internal pull-up resistors.

For more information about the DDC implementation, see the *u-blox 8 / u-blox M8 Receiver Description Including Protocol Specification* [2]. For bandwidth information, see the *CAM-M8 Data Sheet* [1]. For timing parameters, consult the *I²C-bus specification* [6].

- The CAM-M8 DDC interface supports serial communication with u-blox cellular modules. See the specification of the applicable cellular module to confirm compatibility.

1.4.3 TX_READY

The **TX_READY** function is used to indicate when the receiver has data to transmit. A listener can wait on the **TX_READY** signal instead of polling the DDC or SPI interfaces. The UBX-CFG-PRT message lets you configure the polarity and the number of bytes in the buffer before the TX READY signal goes active. The **TX_READY** function can be mapped to **TXD** (PIO 06). The **TX_READY** function is disabled by default.

 The **TX_READY** functionality can be enabled and configured by AT commands sent to the u-blox cellular module supporting the feature. For more information see the *GPS Implementation and Aiding Features in u-blox wireless modules* [7].

1.5 I/O pins

1.5.1 RESET_N: Reset

Driving **RESET_N** low activates a hardware reset of the system. Use this pin only to reset the module. Do not use **RESET_N** to turn the module on and off, since the reset state increases power consumption. The CAM-M8 **RESET_N** pin is for input only.

 The RTC time is also reset (but not BBR).

1.5.2 EXTINT: External interrupt

EXTINT is an external interrupt pin with fixed input voltage thresholds with respect to **VCC** (see the *CAM-M8 Data Sheet* [1] for more information). It can be used for wake-up functions in Power Save Mode on and for aiding. Leave open if unused, function is disabled by default.

If **EXTINT** is not used for an external interrupt function, the pin can be used as a generic PIO (PIO13). For example, the PIO13 can be configured to function as an output pin for the TXD Ready feature to indicate that the receiver has data to transmit. For further information, see *u-blox 8 / u-blox M8 Receiver Description Including Protocol Specification* [2].

Power Control

The power control feature allows overriding the automatic active/inactive cycle of Power Save Mode. The state of the receiver can be controlled through the **EXTINT** pin. The receiver can also be forced OFF using **EXTINT** when Power Save Mode is not active.

Frequency aiding

The **EXTINT** pin can be used to supply time or frequency aiding data to the receiver.

For time aiding, hardware time synchronization can be achieved by connecting an accurate time pulse to the **EXTINT** pin.

Frequency aiding can be implemented by connecting a periodic rectangular signal with a frequency up to 500 kHz and arbitrary duty cycle (low/high phase duration must not be shorter than 50 ns) to the **EXTINT** pin. Provide the applied frequency value to the receiver using UBX messages.

1.5.3 TIMEPULSE

A configurable time pulse signal is available with CAM-M8 antenna modules. By default, the time pulse signal is configured to one pulse per second. For more information, see the *u-blox 8 / u-blox M8 Receiver Description Including Protocol Specification* [2].

1.5.4 SAFEBOOT_N

The **SAFEBOOT_N** pin is for future service, updates and reconfiguration.

Do not pull low during reset

1.5.5 D_SEL: Interface select

The **D_SEL** pin selects the available interfaces. SPI cannot be used simultaneously with UART/DDC. If open, UART and DDC are available. If pulled low, the SPI interface is available, see the *CAM-M8 FW3 Data Sheet* [1] for more information.

1.5.6 LNA_EN: LNA enable

On CAM-M8, in Power Save Mode, the system can turn on/off an optional external LNA using the **LNA_EN** signal in order to optimize power consumption.

Signals: "high" = Turn ON LNA, "low" = Turn OFF LNA

1.6 Electromagnetic interference on I/O lines

Any I/O signal line with a length greater than approximately 3 mm can act as an antenna and may pick up arbitrary RF signals transferring them as noise into the GNSS receiver. This specifically applies to unshielded lines, in which the corresponding GND layer is remote or missing entirely, and lines close to the edges of the printed circuit board.

If, for example, a cellular signal radiates into an unshielded high-impedance line, it is possible to generate noise in the order of volts and not only distort receiver operation but also damage it permanently.

On the other hand, noise generated at the I/O pins will emit from unshielded I/O lines. Receiver performance may be degraded when this noise is coupled into the GNSS antenna (see *Figure 17*).

To avoid interference by improperly shielded lines, it is recommended to use resistors (e.g. $R > 20 \Omega$), ferrite beads (e.g. BLM15HD102SN1) or inductors (e.g. LQG15HS47NJ02) on the I/O lines in series. These components should be chosen with care because they will affect also the signal rise times.

Figure 2 shows an example of EMI protection measures on the RXD/TXD line using a ferrite bead. More information can be found in section 4.3.

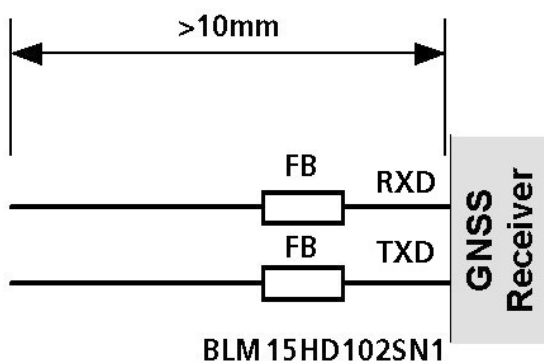

Figure 2: EMI Precautions

2 Design

2.1 Pin description

Function	PIN	No	I/O	Description	Remarks
Power	VCC	9	I	Supply Voltage	Provide clean and stable supply.
	GND	4, 5, 10, 11, 12, 13, 14, 15, 18, 19, 21, 22, 27, 31	I	Ground	Assure a good GND connection to all GND pins of the module
	VCC_IO	1	I	VCC_IO	IO supply voltage. Input must be always supplied. Usually connect to VCC Pin 9
	V_BCKP	8	I	Backup Supply Voltage	It is recommended to connect a backup supply voltage to V_BCKP in order to enable warm and hot Start features on the positioning module. Otherwise, connect to VCC .
Antenna	RF_IN	17	I	GNSS signal input from antenna	Antenna Signal Input (50 Ω) Use a controlled impedance transmission line of 50 Ω to connect to RF_IN .
	RF_OUT	16	O	RF_OUT	Embedded Antenna Output (50 Ω), shall be connected externally to RF_IN
	LNA_EN	30	O	LNA_EN	External LNA control pin in power save mode. LNA_EN pin voltage level is VCC_IO
UART	TXD / SPI MISO	25	O	Serial Port	Serial Port if D_SEL = 1 (or open), SPI MISO if D_SEL = 0 Communication interface can be programmed as TX Ready for DDC interface. Leave open if not used.
	RXD / SPI MOSI	26	I	Serial Port	Serial Port if D_SEL = 1 (or open) SPI MOSI if D_SEL = 0 Serial port input with internal pull-up resistor to VCC. Leave open if not used. Do not use external pull up resistor.
System	RESET_N	23	I	Hardware Reset (Active Low)	Leave open if not used. Do not drive high.
	TIMEPULSE	29	O	Timepulse Signal	Configurable Timepulse signal (one pulse per second by default). Leave open if not used.
	EXTINT / PIO13	7	I / (O)	Ext. Interrupt	Ext. Interrupt Pin. Int. pull-up resistor to VCC . Leave open if unused. The pin can also be used as a generic PIO (PIO13).
	SDA / SPI CS_N	3	I/O	DDC Pins	DDC Data if D_SEL = 1 (or open) SPI Chip Select if D_SEL = 0 Leave open if not used.
	SCL / SPI CLK	6	I	DDC Pins	DDC Clock if D_SEL = 1 (or open) SPI Clock if D_SEL = 0. Leave open if not used.
	D_SEL	20	I	selects the interface	Allow selecting UART/DDC or SPI open-> UART/DDC; low->SPI
	SAFEBOOT_N	24	-	SAFEBOOT_N	Leave open
	Reserved	2, 28	-	Reserved	Leave open

Table 1: CAM-M8 Pinout

2.1.1 Pin name changes

Selected pin names have been updated to agree with a common naming convention across u-blox modules. The pins have not changed their operation and are the same physical hardware but with updated names. The table below lists the pins that have changed name along with their old and new names.

No	Previous Name	New name
3	SDA SPI CS_N	SDA / SPI CS_N
6	SCL SPI CLK	SCL / SPI CLK
16	ANT	RF_OUT
20	DSEL	D_SEL
25	TXD SPI MISO	TXD / SPI MISO
26	RXD SPI MOSI	RXD / SPI MOSI
30	ANT_ON	LNA_EN

Table 2: Pin name changes

2.2 Minimal design

This is a minimal setup for a GNSS receiver with CAM-M8 modules:

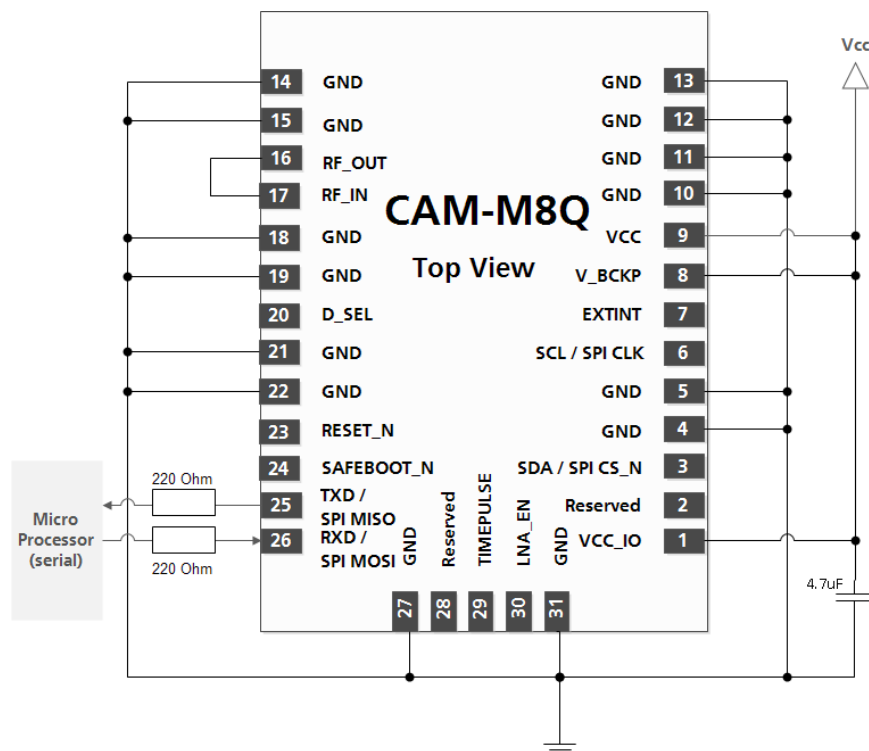

Figure 3: CAM-M8 embedded antenna design

In order to reduce risk for EMI leakage, which can reduce GNSS performance, add 220 Ω series resistors to **TXD** and **RXD**. Also add 220 Ω external series resistors at each digital I/O signal, if being used. See section 4.3 Electromagnetic interference (EMI).

2.3 Suggested pad layout

The suggested paste mask openings are the same as the pad layout. Note the keep-out (void area) 4.8 x 7.2 mm for copper & trace & components for all layers under the embedded chip antenna.

- Be sure to comply with special PCB layout design rules to ensure proper embedded antenna operation when the customer PCB is used as part of antenna. This requires solid ground plane around the module; see section 2.6 for layout suggestions.

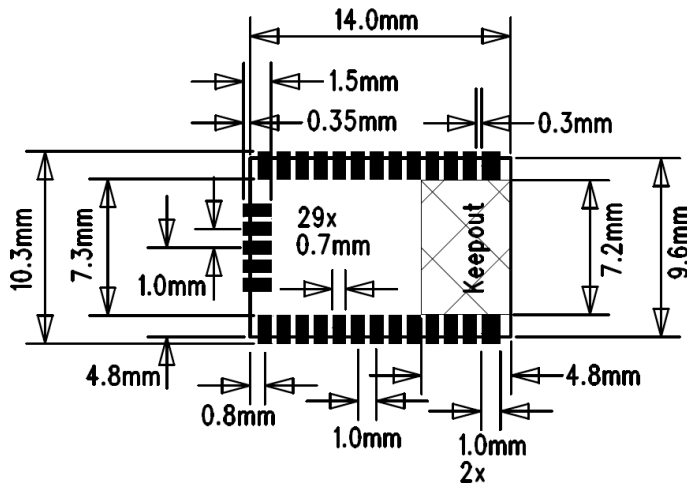

Figure 4: Suggested pad layout and occupied area, top view

2.4 Antenna

CAM-M8 concurrent GNSS modules are designed with an integrated GNSS chip antenna. Optionally, the CAM-M8 can be connected to an external active GNSS antenna.

Antenna input

The module has an embedded GNSS chip antenna and a SAW band-pass filter before LNA, which provides excellent protection against out-of-band GNSS blocking caused by possible near-by wireless transmitters. The signal is further amplified by the internal Low Noise Amplifier (LNA), which is available at **RF_OUT** output.

The antenna signal, **RF_OUT**, shall be connected externally to the **RF_IN** antenna input signal via a short trace between pads. The **RF_OUT** signal and the **RF_IN** are internally AC-coupled.

- Be sure to comply with special PCB layout design rules to ensure proper embedded antenna operation when the customer PCB is used as part of antenna. This requires solid ground plane around the module; see section 2.6 for layout suggestions.

External GNSS antenna connectivity

CAM-M8 modules can also use an external active antenna signal as an optional addition to the embedded chip antenna. An active antenna requires an external antenna switch in order to select the path between **RF_IN** input and the external GNSS antenna signal. When the switch detects the external active antenna presence, e.g. by using the active antenna bias current detection, it switches the antenna signal path to external antenna. When the module is in Standby or Backup state, the antenna switch and bias can be switched off externally by using **LNA_EN** signal output.

- Use 100 k Ω (typ.) external pull down resistor at **LNA_EN** signal whenever the signal is used externally.

A second option is to use a suitable RF-conductor with built-in switching operation. The customer may use an external active GNSS antenna connected with a RF-conductor (e.g. MCX) + Switch combo (e.g. Aliner 36-301AA). It is suggested that the active antenna has a net gain *including cable loss* in the range of +10 dB to +30 dB. Specified sensitivity is measured with an external low noise ($NF \leq 1\text{dB}$, $G \geq 15\text{dB}$) amplifier. The antenna shall provide simultaneous reception of GPS, GLONASS, BeiDou and QZSS signals.

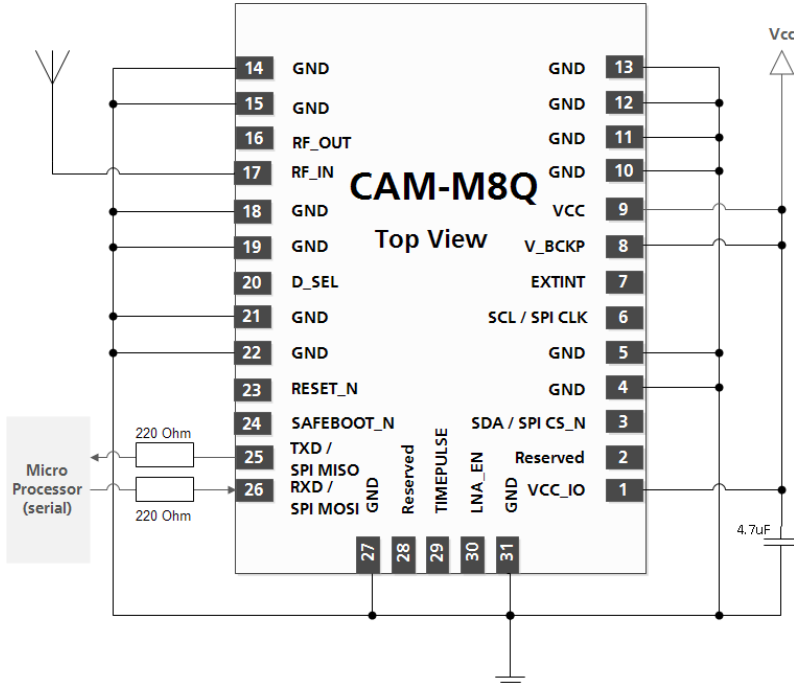

Figure 5: External GNSS antenna

External active antenna

The **LNA_EN** pin can be used to turn on and off an external LNA. This reduces power consumption in Power Save Mode (Back up mode).

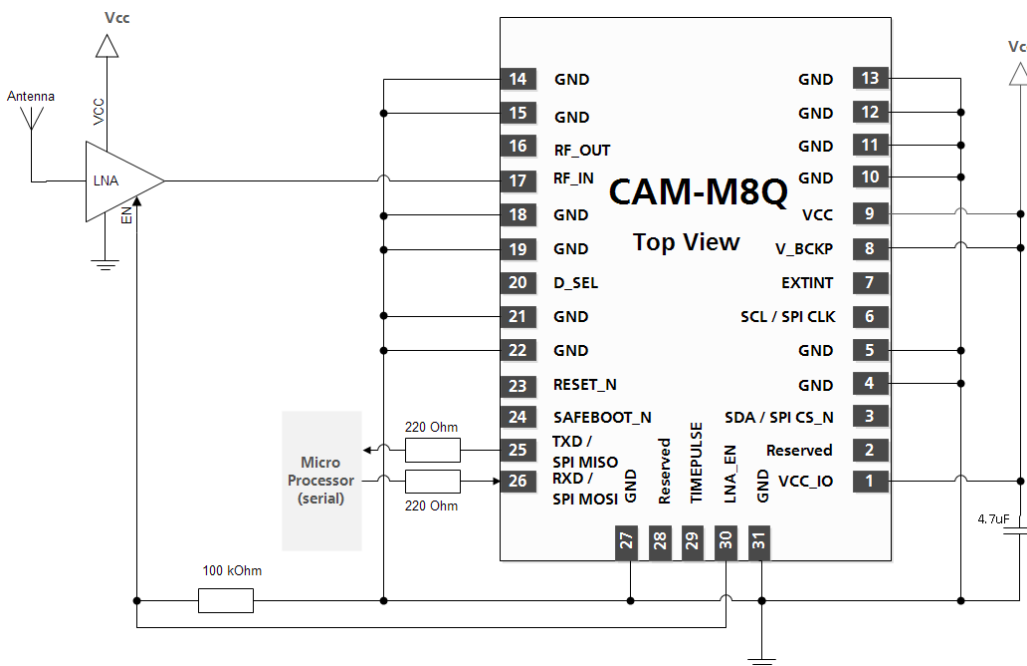

Figure 6: External active antenna

2.5 Embedded antenna operation

The embedded GNSS antenna provides optimal radiation efficiency of 80% (typ.) with an 80 x 40 mm ground plane. The antenna provides linear polarization with a peak gain of 1.1 dBi and a radiation pattern optimized for portable devices. The antenna is insensitive to surroundings and has high tolerance against frequency shifts. However, on small ground plane widths, the antenna gain and radiation efficiency is reduced. For example, a 45 mm wide application board reduces signal levels by at least 6 dB as compared to full 80 x 40 mm ground plane dimensions. *Figure 7* shows the typical free space radiation patterns at 1575 GHz. The radiation pattern of the embedded GNSS antenna is shown in *Figure 7* (on an 80 x 40 mm ground plane).

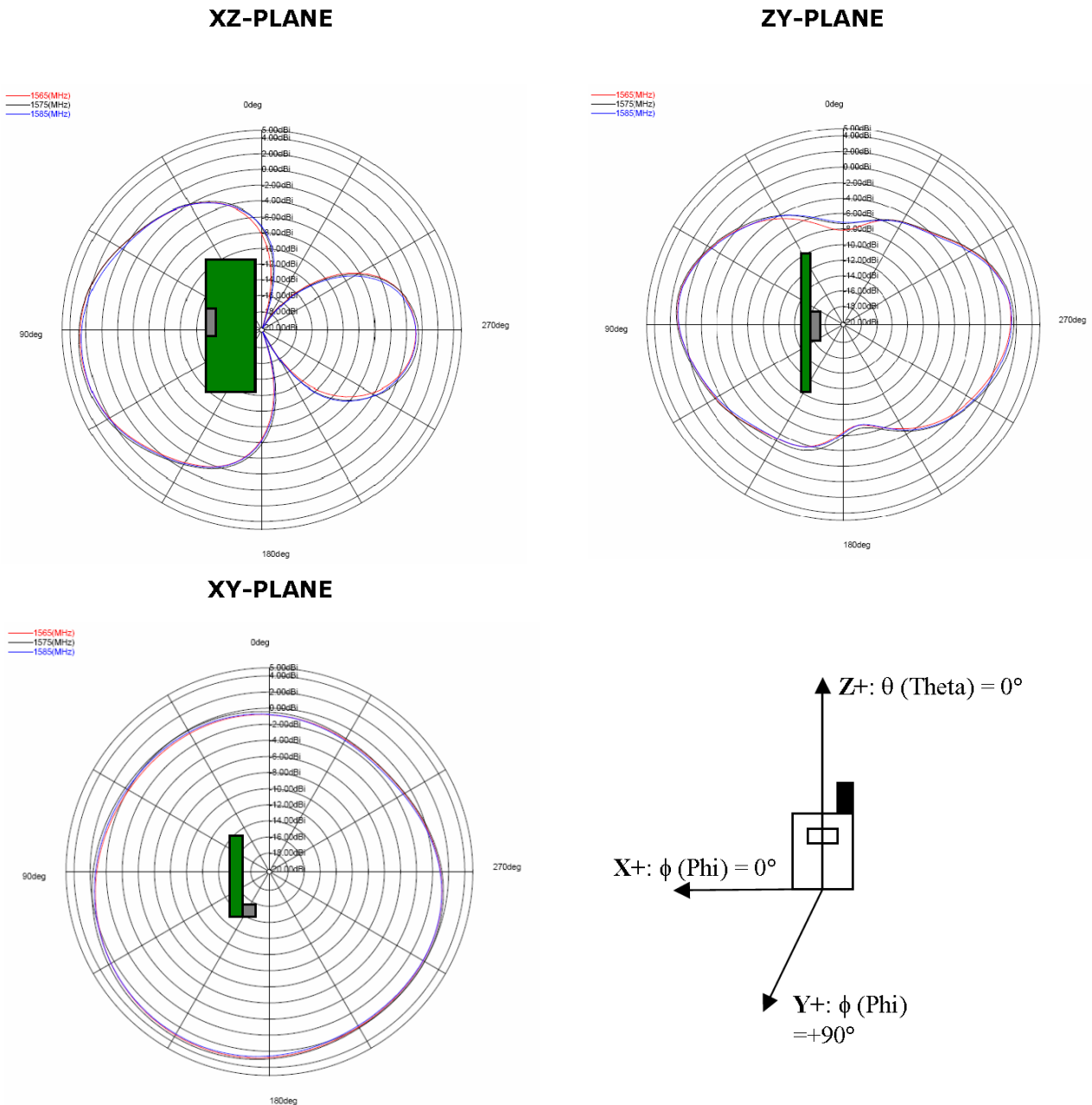

Figure 7: 1.575 GHz typical free space radiation patterns

Avoid placement of the module at a corner of the motherboard. This will reduce radiation efficiency and cause frequency shifts. Optimal placement is at center of top edge; keep at least 10 mm distance to nearest ground plane corner.

Tall nearby components ($h > 3$ mm) should be placed at least $d = 6$ mm away from the embedded antenna. In addition, any adjacent conductive metal plane should have a distance $d = 6$ mm to the top edge of the module. An enclosure or plastic cover should have a minimum distance $d = 1.5$ mm to the antenna.

Placement near a human body (or any biological tissue) is accepted by keeping a minimum distance $d = 10$ mm between motherboard and the body. With smaller distances to the body, the radiation efficiency of the antenna will start to reduce due to signal losses in biological tissue. E.g. $d = 5$ mm to biological tissue will reduce GPS signal levels by about 6 dB. Note that the body will also act as a reflector, and thus the radiation pattern will point perpendicular to the body.

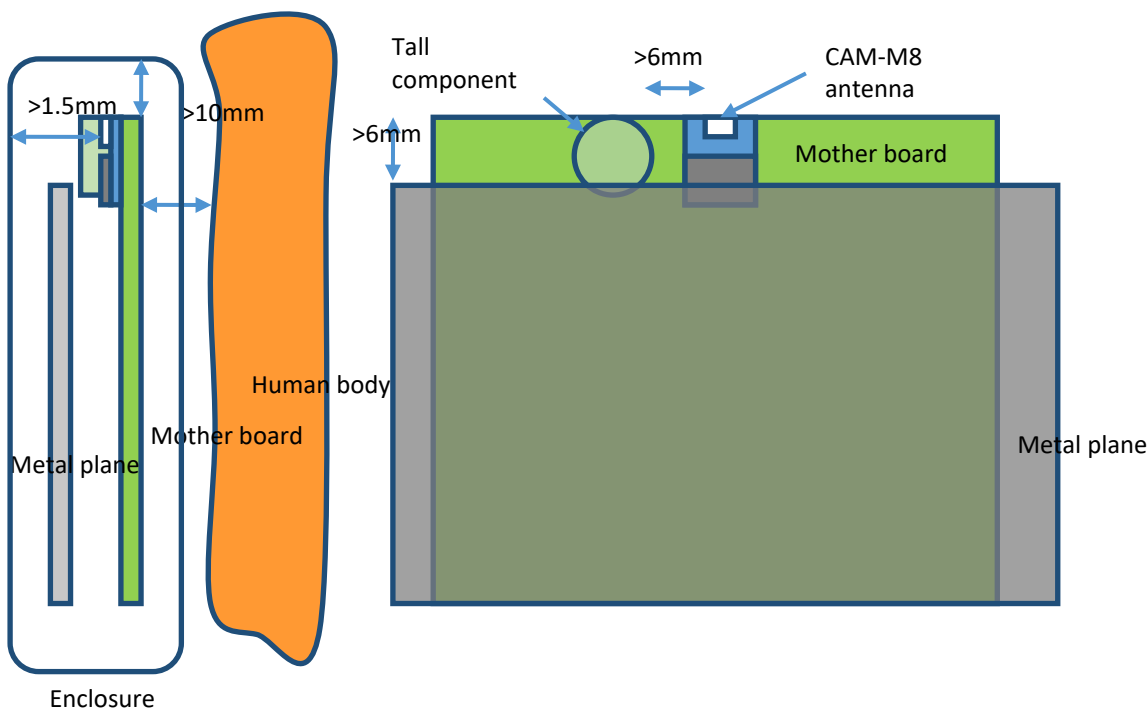

Figure 8: Placement of CAM-M8 relative to surroundings

2.6 PCB layout suggestion

The suggested 4-layer PCB build-up is presented in the following table.

Layer	Description
1	Components + ground plane (opening under CAM-M8 antenna)
2	Signals and RF trace (opening under CAM-M8 antenna)
3	Ground and power planes, signals (opening under CAM-M8 antenna)
4	Ground plane, also short traces allowed (opening under CAM-M8 antenna)

Table 3: Suggested PCB build-up

CAM-M8 antenna modules are intended to be placed at the top edge of the motherboard. The embedded antenna operation relies on the ground plane on the motherboard. The optimum size is 80 x 40 mm, but a larger or smaller ground plane can be used. The suggested minimum ground plane size is 45 x 20 mm for rectangular and $r = 60$ mm for circular ground plane. Optimum placement is at the center of the top edge, but offset placement is allowed by keeping at least 10 mm distance to the nearest ground plane edge. Although a ground plane width of 45 mm is the suggested minimum, to

maximize performance it is recommended to extend the width as far as possible. Conversely, increasing the height of the ground plane beyond 20 mm has little to no effect on antenna performance.

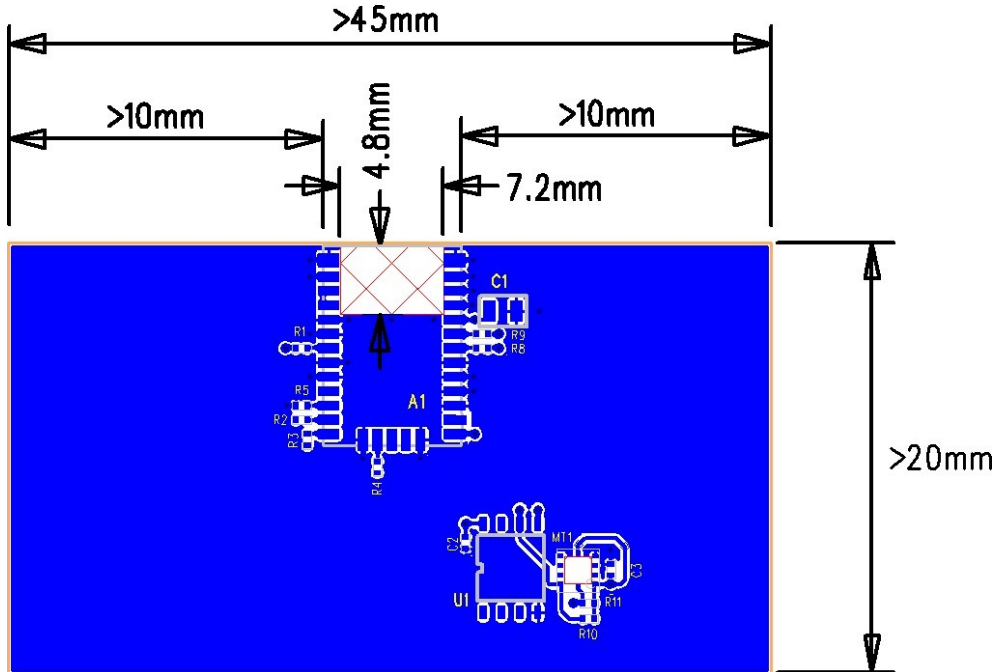

Figure 9: Motherboard ground plane and CAM-M8 placement

- Keep out 4.8 x 7.2 mm under the embedded antenna. Follow also GND via hole suggested locations.

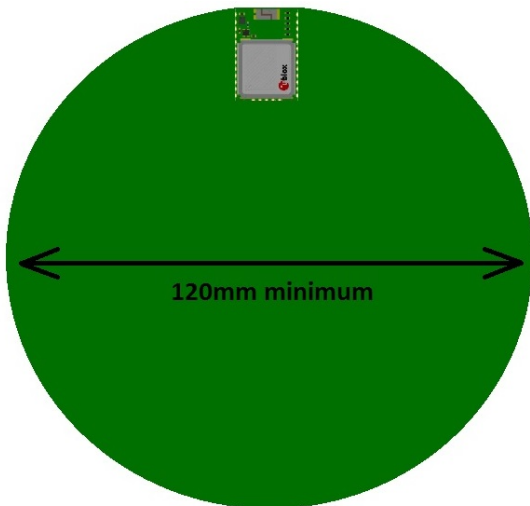

Figure 10: Suggested minimum size is $r = 60$ mm for circular ground plane.

Routing signals directly under the module should be avoided. This area should be dedicated as keep-out to both traces and assigned to ground plane (copper plane), except for via holes, which can be placed close to the pad under the module. If possible, the number of via holes underneath the module should be minimized.

Note that the embedded GNSS antenna requires a small ground plane clearance and void area (keep out 4.8 x 7.2 mm) for copper plane & trace for all layers under the antenna. Placement of other components is not allowed under the keep-out on opposite side.

For a multi-layer PCB, the inner layers below the CAM-M8 antenna modules are suggested to be dedicated signal traces and copper plane for the rest of the area. It is always better to route very long signal traces in the inner layers of the PCB. In this way, the trace can be easily shielded with ground areas from above and below.

The serial resistors at the I/O should be placed as close to the CAM-M8 antenna modules as possible in order to minimize the risk for the EMI leakage. For the same reason, by-pass supply capacitors should be connected very close to the module with short traces to IO contacts and to the ground plane. Place a GND via hole as close as possible to the capacitor. Other components on the motherboard can be added close to the module but a solid ground plane requirement must be maintained in internal and/or on opposite side of the PCB.

Connect the GND soldering pads of the CAM-M8 antenna modules to the ground plane with short traces (thermals) to via holes, which are connected to the ground plane. Preferably, use one via hole for each GND pad.

It is suggested to route an RF signal clearly away from other signals, between two ground planes as a Stripline Transmission Line; this minimizes the possibility of interference and coupling. The proper width for the 50 Ω transmission line impedance depends on the dielectric material of the substrate, width of the signal trace and the height (separation) of the two ground planes. With FR-4 material, the width of the trace shall be about 30% of the ground plane height. E.g., 0.4 mm ground plane height results to 0.15 mm trace width with FR-4 substrate.

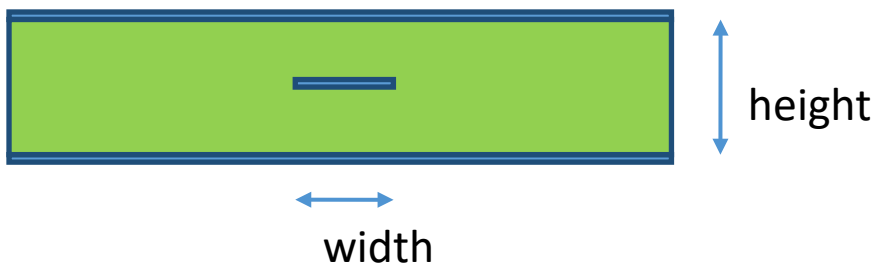

Figure 11: Stripline transmission line

Any board space free of signal traces should be covered with copper areas connected to ground net; in this way, a solid RF ground plane is achieved throughout the circuit board. Several via holes should be used to connect the ground areas between different layers.

Additionally, it is important that the PCB build-up is symmetrical on both sides of the PCB core. This can be achieved by choosing identical copper content on each layers, and adding copper areas to route-free areas. If the circuit board is heavily asymmetric, the board may bend (wrap) during the PCB manufacturing or reflow soldering. Bending and wrapping may cause soldering failures and reduce end product reliability.

A reference board layout described in next chapter can be also used as layout reference implementation.

In addition, a 2-layer PCB motherboard design is possible in order to reduce PCB cost, but the layout design must be made carefully to fulfill ground plane minimum size requirements. The following pictures show suggested 2-layer GND plane and signal trace routing.

Notes on a 2-layer PCB motherboard design:

- Keep Bottom side ground plane as solid as possible; at least the minimum recommended 45 x 20 mm
- Route signal traces away from the module on Top layer
- When necessary, allow signal swap from top to bottom layer clearly away from module > 20 mm
- Use copper pour ground planes on top and bottom layers; use multiple GND net via holes to tie separate ground plane areas tightly together

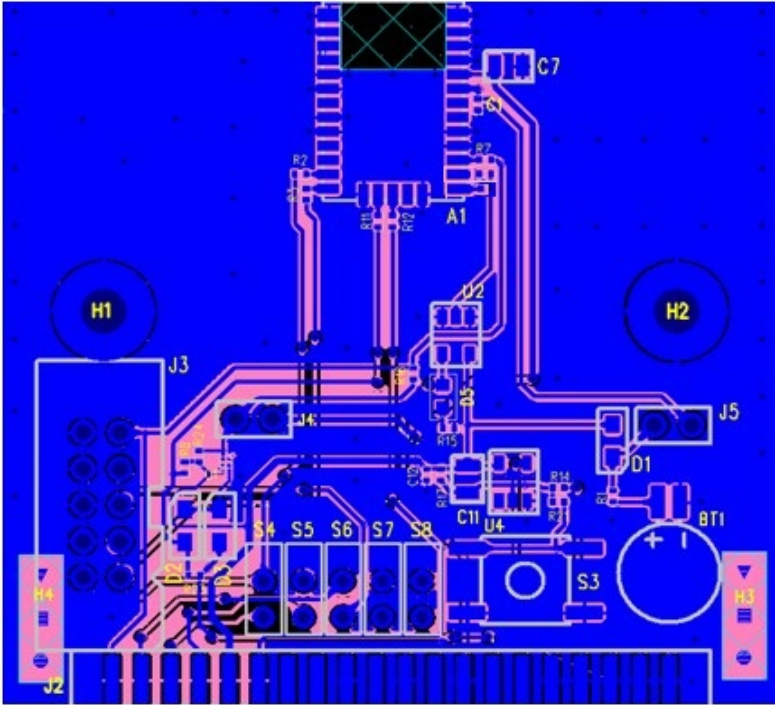

Figure 12: Example of 2-layer PCB, top layer

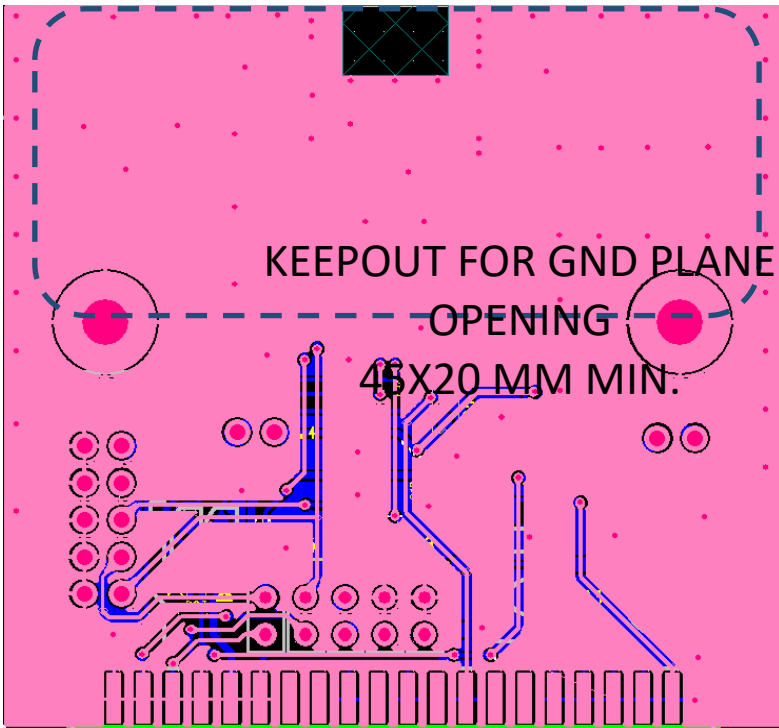



Figure 13: Example of 2-layer PCB, bottom layer

3 Product handling

3.1 Packaging, shipping, storage and moisture preconditioning

For information pertaining to reels and tapes, Moisture Sensitivity levels (MSL), shipment and storage information, as well as drying for preconditioning see the *CAM-M8 Data Sheet* [1].

Population of Modules

-  When populating the modules, make sure that the pick and place machine is aligned to the copper pins of the module and not to the module edge.

3.2 Soldering

Soldering paste

Use of "No Clean" soldering paste is strongly recommended, as it does not require cleaning after the soldering process has taken place. The paste listed in the example below meets these criteria.

Soldering Paste: OM338 SAC405 / Nr.143714 (Cookson Electronics)

Alloy specification: Sn 95.5/ Ag 4/ Cu 0.5 (95.5% Tin/ 4% Silver/ 0.5% Copper)

Melting Temperature: 217 °C

Stencil Thickness: 150 µm

The final choice of the soldering paste depends on the approved manufacturing procedures.

The paste-mask geometry for applying soldering paste should meet the recommendations.

-  The quality of the solder joints on the connectors ("half vias") should meet the appropriate IPC specification.

Reflow soldering

A convection type soldering oven is highly recommended over the infrared type radiation oven. Convection heated ovens allow precise control of the temperature, and all parts will heat up evenly, regardless of material properties, thickness of components and surface color.

As a reference, see the "IPC-7530 Guidelines for temperature profiling for mass soldering (reflow and wave) processes", published in 2001.

Preheat phase

During the initial heating of component leads and balls, residual humidity will be dried out. Note that this preheat phase will not replace prior baking procedures.

- Temperature rise rate: max. 3 °C/s. If the temperature rise is too rapid in the preheat phase it may cause excessive slumping.
- Time: 60 - 120 s. If the preheat is insufficient, rather large solder balls tend to be generated. Conversely, if performed excessively, fine balls and large balls will be generated in clusters.
- End Temperature: 150 - 200 °C. If the temperature is too low, non-melting tends to be caused in areas containing large heat capacity.

Heating/ Reflow phase

The temperature rises above the liquidus temperature of 217°C. Avoid a sudden rise in temperature as the slump of the paste could become worse.

- Limit time above 217 °C liquidus temperature: 40 - 60 s

- Peak reflow temperature: 245 °C

Cooling phase

A controlled cooling avoids negative metallurgical effects of the solder (becoming more brittle) and possible mechanical tensions in the products. Controlled cooling helps to achieve bright solder fillets with a good shape and low contact angle.

- Temperature fall rate: max 4 °C/s

 To avoid falling off, the CAM-M8 antenna module should be placed on the topside of the motherboard during soldering.

The final soldering temperature chosen at the factory depends on additional external factors such as choice of soldering paste, size, thickness and properties of the baseboard. Exceeding the maximum soldering temperature in the recommended soldering profile may permanently damage the module.

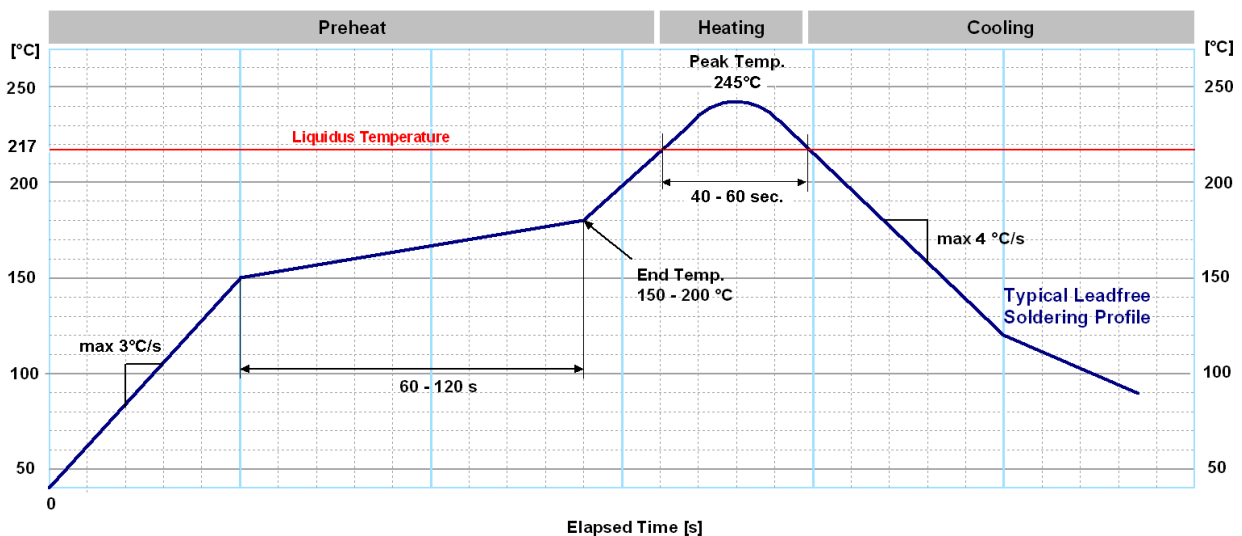



Figure 14: Recommended soldering profile

 CAM-M8 modules **must not** be soldered with a damp heat process.

Optical inspection

After soldering the CAM-M8 antenna module, consider an optical inspection step to check whether:

- The module is properly aligned and centered over the pads
- All pads are properly soldered
- No excess solder has created contacts to neighboring pads, or possibly to pad stacks and vias nearby

Cleaning

In general, cleaning the populated modules is strongly discouraged. Residues underneath the modules cannot be easily removed with a washing process.

- Cleaning with water will lead to capillary effects where water is absorbed in the gap between the baseboard and the module. The combination of residues of soldering flux and encapsulated water leads to short circuits or resistor-like interconnections between neighboring pads.
- Cleaning with alcohol or other organic solvents can result in soldering flux residues flooding into the two housings, areas that are not accessible for post-wash inspections. The solvent will also damage the sticker and the ink-jet printed text.
- Ultrasonic cleaning will permanently damage the module, in particular the quartz oscillators.

The best approach is to use a "no clean" soldering paste and eliminate the cleaning step after the soldering.

Repeated reflow soldering

Only single reflow soldering processes are recommended for boards populated with CAM-M8 antenna modules. The CAM-M8 antenna modules should not be submitted to two reflow cycles on a board populated with components on both sides in order to avoid upside down orientation during the second reflow cycle. In this case, the modules should always be placed on the side of the board that is submitted into the last reflow cycle. The reason for this (besides others) is the risk of the module falling off due to the significantly higher weight in relation to other components.

Two reflow cycles can be considered by excluding the above described upside down scenario and taking into account the rework conditions described in the section 4 Product handling.

 Repeated reflow soldering processes and soldering the module upside down are not recommended.

Wave soldering

Baseboards with combined through-hole technology (THT) components and surface-mount technology (SMT) devices require wave soldering to solder the THT components. Only a single wave soldering process is encouraged for boards populated with CAM-M8 antenna modules.

Hand soldering

Hand soldering is allowed. Use a soldering iron temperature setting equivalent to 350 °C. Place the module precisely on the pads. Start with a cross-diagonal fixture soldering (e.g. pins 1 and 15), and then continue from left to right.

Rework

The CAM-M8 modules can be unsoldered from the baseboard using a hot air gun. When using a hot air gun for unsoldering the module, a maximum of one reflow cycle is allowed. In general, we do not recommend using a hot air gun because this is an uncontrolled process and might damage the module.

 Attention: use of a hot air gun can lead to overheating and severely damage the module. Always avoid overheating the module.

After the module is removed, clean the pads before placing and hand soldering a new module.

 Never attempt a rework on the module itself, e.g. replacing individual components. Such actions immediately terminate the warranty.

In addition to the two reflow cycles, manual rework on particular pins by using a soldering iron is allowed. Manual rework steps on the module can be done several times.

Conformal coating

Certain applications employ a conformal coating of the PCB using HumiSeal® or other related coating products. These materials affect the HF properties of the GNSS module and it is important to prevent them from flowing into the module. The RF shields do not provide 100% protection for the module from coating liquids with low viscosity; therefore, care is required in applying the coating.

 Conformal Coating of the module will void the warranty.

Casting

If casting is required, use viscose or another type of silicon pottant. The OEM is strongly advised to qualify such processes in combination with the CAM-M8 antenna modules before implementing this in the production.

 Casting will void the warranty.

Grounding metal covers

Attempts to improve grounding by soldering ground cables, wick or other forms of metal strips directly onto the EMI covers is done at the customer's own risk. The numerous ground pins should be sufficient to provide optimum immunity to interferences and noise.

 u-blox makes no warranty for damages to the CAM-M8 antenna modules caused by soldering metal cables or any other forms of metal strips directly onto the EMI covers.

Use of ultrasonic processes

Some components on the CAM-M8 modules are sensitive to ultrasonic waves. Use of any ultrasonic processes (cleaning, welding etc.) may cause damage to the GNSS Receiver.

 u-blox offers no warranty against damages to the CAM-M8 antenna modules caused by any ultrasonic processes.

3.3 EOS/ESD/EMI precautions

When integrating GNSS positioning modules into wireless systems, careful consideration must be given to electromagnetic and voltage susceptibility issues. Wireless systems include components that can produce Electrical Overstress (EOS) and Electro-Magnetic Interference (EMI). CMOS devices are more sensitive to such influences because their failure mechanism is defined by the applied voltage, whereas bipolar semiconductors are more susceptible to thermal overstress. The following design guidelines are provided to help in designing robust yet cost effective solutions.

 To avoid overstress damage during production or in the field it is essential to observe strict EOS/ESD/EMI handling and protection measures.

 To prevent overstress damage at the RF_IN of your receiver, never exceed the maximum input power (see the *CAM-M8 Data Sheet* [1]).

Electrostatic discharge (ESD)

Electrostatic discharge (ESD) is the sudden and momentary electric current that flows between two objects at different electrical potentials caused by direct contact or induced by an electrostatic field. The term is usually used in the electronics and other industries to describe momentary unwanted currents that may cause damage to electronic equipment.



ESD handling precautions

ESD prevention is based on establishing an Electrostatic Protective Area (EPA). The EPA can be a small working station or a large manufacturing area. The main principle of an EPA is that there are no highly charging materials near ESD sensitive electronics, all conductive materials are grounded, workers are grounded, and charge build-up on ESD sensitive electronics is prevented. International standards are used to define typical EPA and can be obtained for example from International Electrotechnical Commission (IEC) or American National Standards Institute (ANSI).

GNSS positioning modules are sensitive to ESD and require special precautions when handling. Particular care must be exercised when handling patch antennas, due to the risk of electrostatic charges. In addition to standard ESD safety practices, the following measures should be taken into account whenever handling the receiver.

- Unless there is a galvanic coupling between the local GND (i.e. the work table) and the PCB GND, then the first point of contact when handling the PCB must always be between the local GND and PCB GND.
- Before mounting an antenna patch, connect ground of the device
- When handling the RF pin, do not come into contact with any charged capacitors and be careful when contacting materials that can develop charges (e.g. patch antenna ~10 pF, coax cable ~50 - 80 pF/m, soldering iron, ...)
- To prevent electrostatic discharge through the RF input, do not touch any exposed antenna area. If there is any risk that such exposed antenna area is touched in non ESD protected work area, implement proper ESD protection measures in the design.
- When soldering RF connectors and patch antennas to the receiver's RF pin, make sure to use an ESD safe soldering iron (tip).



Failure to observe these precautions can result in severe damage to the GNSS module!

ESD protection measures

- GNSS positioning modules are sensitive to Electrostatic Discharge (ESD). Special precautions are required when handling.
- For more robust designs, employ additional ESD protection measures. Using an active antenna with appropriate ESD rating can provide increases ESD protection.

Most defects caused by ESD can be prevented by following strict ESD protection rules for production and handling.

Electrical overstress (EOS)

Electrical overstress (EOS) usually describes situations when the maximum input power exceeds the maximum specified ratings. EOS failure can happen if RF emitters are close to a GNSS receiver or its antenna. EOS causes damage to the chip structures. If the RF_IN is damaged by EOS, it is hard to determine whether the chip structures have been damaged by ESD or EOS.

EOS protection measures

For designs with GNSS positioning modules and wireless (e.g. GSM/GPRS) transceivers in close proximity, ensure sufficient isolation between the wireless and GNSS antennas. If wireless power output causes the specified maximum power input at the GNSS RF_IN to be exceeded, employ EOS protection measures to prevent overstress damage.

For robustness, the EOS protection measures shown in *Figure 15* are recommended for designs combining wireless communication transceivers (e.g. GSM, GPRS) and GNSS in the same design or in close proximity.

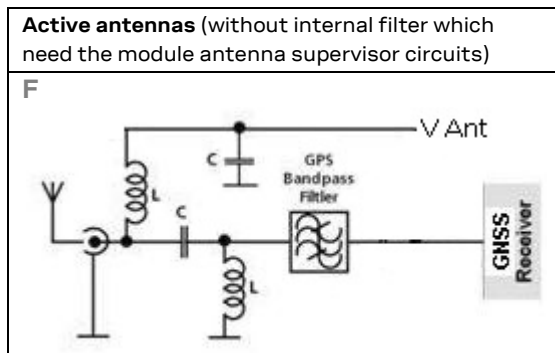

Figure 15: EOS and ESD Precautions

3.3.1 Electromagnetic interference (EMI)

Electromagnetic interference (EMI) is the addition or coupling of energy originating from any RF emitting device. This can cause a spontaneous reset of the GNSS receiver or result in unstable performance. Any unshielded line or segment (>3 mm) connected to the GNSS receiver can effectively act as antenna and lead to EMI disturbances or damage.

The following elements are critical regarding EMI:

- Unshielded connectors (e.g. pin rows etc.)
- Weakly shielded lines on PCB (e.g. on top or bottom layer and especially at the border of a PCB)
- Weak GND concept (e.g. small and/or long ground line connections)

EMI protection measures are recommended when RF emitting devices are near the GNSS receiver. To minimize the effect of EMI a robust grounding concept is essential. To achieve electromagnetic robustness follow the standard EMI suppression techniques.

<http://www.murata.com/products/emc/knowhow/index.html>
<http://www.murata.com/products/emc/knowhow/pdf/4to5e.pdf>

Improved EMI protection can be achieved by inserting a resistor (e.g. $R > 20 \Omega$), or better yet a ferrite bead (BLM15HD102SN1) or an inductor (LQG15HS47NJ02), into any unshielded PCB lines connected to the GNSS receiver. Place the resistor as close as possible to the GNSS receiver pin.

Alternatively, feed-thru capacitors with good GND connection can be used to protect e.g. the **VCC** supply pin against EMI. A selection of feed-thru capacitors are listed in Table 6.

Intended use

In order to mitigate any performance degradation of a radio equipment under EMC disturbance, system integration shall adopt appropriate EMC design practice and not contain cables over three meters on signal and supply ports.

3.4 Applications with cellular modules

GSM terminals transmit power levels up to 2 W (+33 dBm) peak, 3G and LTE up to 250 mW continuous. Consult the *corresponding product data sheet* in Related documents for the absolute maximum power input at the GNSS receiver.

See the GPS Implementation and Aiding Features in u-blox wireless modules [7].

Isolation between GNSS and cellular antenna

In a handheld type design, an isolation of approximately 20 dB can be reached with careful placement of the antennas. If such isolation cannot be achieved, e.g. in the case of an integrated cellular /GNSS antenna, an additional input filter is needed on the GNSS side to block the high energy emitted by the cellular transmitter. Examples of these kinds of filters would be the SAW Filters from Epcos (B9444 or B7839) or Murata.

Increasing interference immunity

Interference signals come from in-band and out-band frequency sources.

In-band interference

With in-band interference, the signal frequency is very close to the GNSS constellation frequency used, e.g. GPS frequency of 1575 MHz (see *Figure 16*). Such interference signals are typically caused by harmonics from displays, micro-controller, bus systems, etc.

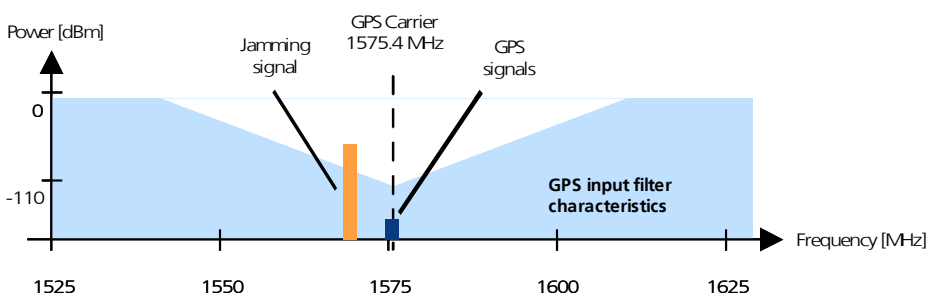

Figure 16: In-band interference signals

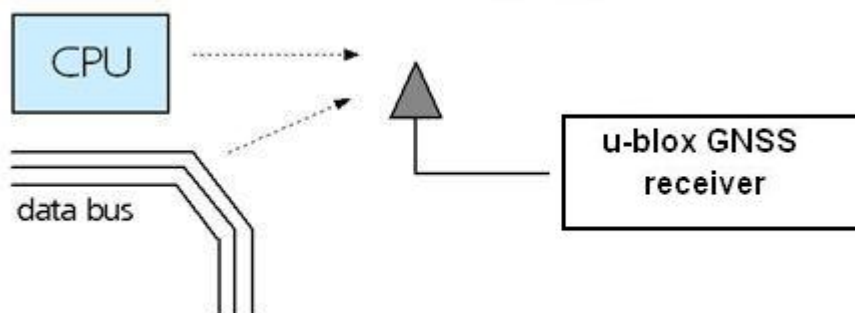

Figure 17: In-band interference sources

Measures against in-band interference include:

- Maintaining a good grounding concept in the design
- Shielding
- Layout optimization
- Filtering
- Placement of the GNSS antenna
- Adding a CDMA, cellular, WCDMA band pass filter before handset antenna

Out-band interference

Out-band interference is caused by signal frequencies that are different from the GNSS carrier (see *Figure 18*). The main sources are wireless communication systems such as cellular, CDMA, WCDMA, Wi-Fi, BT, etc.

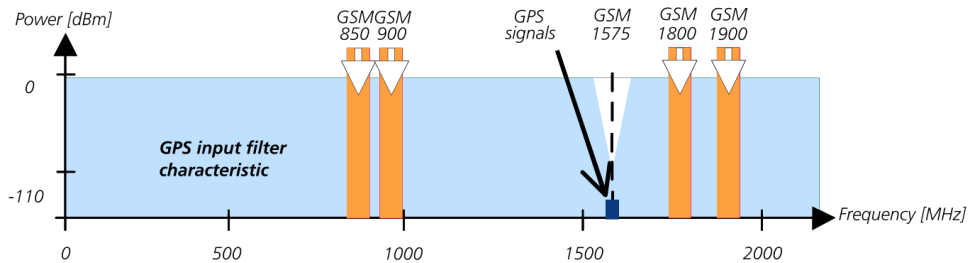

Figure 18: Out-band interference signals

Measures against out-band interference include maintaining a good grounding concept in the design and adding a SAW or band pass ceramic filter (as recommend in section 3) into the antenna input line to the GNSS receiver (see *Figure 19*).



Figure 19: Measures against out-band interference

See the GPS Implementation and Aiding Features in u-blox wireless modules [7]

Appendix

A Glossary

Abbreviation	Definition
ANSI	American National Standards Institute
BeiDou	Chinese navigation satellite system
CDMA	Code Division Multiple Access
EMC	Electromagnetic compatibility
EMI	Electromagnetic interference
EOS	Electrical Overstress
EPA	Electrostatic Protective Area
ESD	Electrostatic discharge
Galileo	European navigation system
GLONASS	Russian satellite system
GND	Ground
GNSS	Global Navigation Satellite System
GPS	Global Positioning System
GSM	Global System for Mobile Communications
IEC	International Electrotechnical Commission
PCB	Printed circuit board
QZSS	Quasi-Zenith Satellite System

Table 4: Explanation of the abbreviations and terms used

B Recommended parts

Recommended parts are selected on data sheet basis only. Other components may also be used.

Manufacturer	Part ID	Remarks	Parameters to consider
Diode ON Semiconductor	ESD9R3.3ST5G	Standoff Voltage>3.3 V	Low Capacitance < 0.5 pF
	ESD9L3.3ST5G	Standoff Voltage>3.3 V	Standoff Voltage > Voltage for active antenna
	ESD9L5.0ST5G	Standoff Voltage>5 V	Low Inductance
SAW	TDK/ EPCOS B8401: B39162-B8401-P810	GPS+GLONASS	High attenuation
	TDK/ EPCOS B3913: B39162B3913U410	GPS+GLONASS+BeiDou	For automotive application
	TDK/ EPCOS B4310: B39162B4310P810	GPS+GLONASS	Compliant to the AEC-Q200 standard
	ReyConns NDF9169	GPS+BeiDou	Low insertion loss, Only for mobile application
	muRata SAFFB1G56KB0F0A	GPS+GLONASS+BeiDou	Low insertion loss, Only for mobile application
	muRata SAFEA1G58KB0F00	GPS+GLONASS	Low insertion loss, only for mobile application
	muRata SAFEA1G58KA0F00	GPS+GLONASS	High attenuation, only for mobile application

Manufacturer	Part ID	Remarks	Parameters to consider
muRata	SAFFB1G58KA0F0A	GPS+GLONASS	High attenuation, only for mobile application
muRata	SAFFB1G58KB0F0A	GPS+GLONASS	Low insertion loss, Only for mobile application
TAI-SAW	TA1573A	GPS+GLONASS	Low insertion loss
TAI-SAW	TA1343A	GPS+GLONASS+BeiDou	Low insertion loss
TAI-SAW	TA0638A	GPS+GLONASS+BeiDou	Low insertion loss
LNA	JRC	NJG1143UA2	LNA Low noise figure, up to 15 dBm RF input power
Inductor	Murata	LQG15H Series, e.g. LQG15HS47NJ02 LQG15HN27NJ02	L, 47 nH down to 27 nH Impedance @ freq GPS > 500 Ω
	Murata	LQW15A Series, e.g. LQW15AN47NJ80 LQW15AN75NJ80	L, 47 nH up to 75 nH
	Johanson Technology	L-07W Series e.g. 39 nH L-07W39NJV4T	or any other inductance compatible with the above MuRata inductors
Capacitor	Murata	GRM1555C1E470JZ01	C, 47 pF DC-block
Ferrite Bead	Murata	BLM15HD102SN1	FB High IZI @ fGSM
Feed thru Capacitor for Signal	Murata	NFL18SP157X1A3	Monolithic Type For data signals, 34 pF load capacitance
		NFA18SL307V1A45	Array Type For data signals, 4 circuits in 1 package
Feed thru Capacitor	Murata	NFM18PC	0603 2A Rs < 0.5 Ω
		NFM21P....	0805 4A
Resistor		10 Ω ± 10%, min 0.250 W	R _{bias}
		560 Ω ± 5%	R2
		100 kΩ ± 5%	R3, R4

Table 5: Recommended parts

Recommended antennas

Manufacturer	Order No.	Comments
Hirschmann (www.hirschmann-car.com)	GLONASS 9 M	GPS+GLONASS active
Taoglas (www.taoglas.com)	AA.160.301111	36*36*4 mm, 3-5V 30mA active
Taoglas (www.taoglas.com)	AA.161.301111	36*36*3 mm, 1.8 to 5.5V / 10mA at 3V active
INPAQ (www.inpaq.com.tw)	B3G02G-S3-01-A	2.7 to 3.9 V / 10 mA active
Amotech (www.amotech.co.kr)	B35-3556920-2J2	35x35x3 mm GPS+GLONASS passive
Amotech (www.amotech.co.kr)	A25-4102920-2J3	25x25x4 mm GPS+GLONASS passive
Amotech (www.amotech.co.kr)	A18-4135920-AMT04	18x18x4 mm GPS+GLONASS passive
Amotech (www.amotech.co.kr)	Amotech AGA363913-S0-A1	GPS+GLONASS+ BeiDou active
INPAQ (www.inpaq.com.tw)	ACM4-5036-A1-CC-S	5.2 x 3.7 x 0.7 mm GPS+GLONASS passive

Additional antenna Manufacturer: Allis Communications, Tallysman Wireless

Table 6: Recommend antenna

Related documents

- [1] CAM-M8 (FW3) Data Sheet, Doc. No. [UBX-15031574](#)
- [2] u-blox 8 / u-blox M8 Receiver Description Including Protocol Specification (Public version), Doc. No. [UBX-13003221](#)
- [3] GNSS FW3.01 Release Notes (Public version), Doc. No. [UBX-16000319](#)
- [4] GPS Antenna Application Note, Doc. No. GPS-X-08014
- [5] GPS Compendium, Doc. No. GPS-X-02007
- [6] I2C-bus specification, Rev. 6 - 4 April 2014,
http://www.nxp.com/documents/user_manual/UM10204.pdf
- [7] GPS Implementation and Aiding Features in u-blox wireless modules, Doc. No. GSM.G1-CS-09007
- [8] u-blox M8 FW SPG3.01 Migration Guide, Doc. No. [UBX-15028330](#)

 For regular updates to u-blox documentation and to receive product change notifications, register on our homepage (www.u-blox.com).

Revision history

Revision	Date	Name	Comments
R01	15-Sep-2016	jfur	Advance Information
R02	8-Nov-2016	jesk	Production Information
R03	20-Nov-2017	msul	Added information on RED DoC in European Union regulatory compliance (page 2), added Intended use statement in section 4.3 EOS/ESD/EMI precautions, updated legal statement in cover page and added Documentation feedback e-mail address in contacts page.
R04	7-Feb-2019	rmak	Added information on EXTINT pin usage as generic PIO13 in Section 2.1 and Table 1: CAM-M8 Pinout. Updated Table 6.

Contact

For complete contact information, visit us at www.u-blox.com.

u-blox Offices

North, Central and South America

u-blox America, Inc.

Phone: +1 703 483 3180

E-mail: info_us@u-blox.com

Regional Office West Coast:

Phone: +1 408 573 3640

E-mail: info_us@u-blox.com

Technical Support:

Phone: +1 703 483 3185

E-mail: support@u-blox.com

Headquarters

Europe, Middle East, Africa

u-blox AG

Phone: +41 44 722 74 44

E-mail: info@u-blox.com

Support: support@u-blox.com

Asia, Australia, Pacific

u-blox Singapore Pte. Ltd.

Phone: +65 6734 3811

E-mail: info_ap@u-blox.com

Support: support_ap@u-blox.com

Regional Office Australia:

Phone: +61 2 8448 2016

E-mail: info_au@u-blox.com

Support: support_ap@u-blox.com

Regional Office China (Beijing):

Phone: +86 10 68 133 545

E-mail: info_cn@u-blox.com

Support: support_cn@u-blox.com

Regional Office China (Chongqing):

Phone: +86 23 6815 1588

E-mail: info_cn@u-blox.com

Support: support_cn@u-blox.com

Regional Office China (Shanghai):

Phone: +86 21 6090 4832

E-mail: info_cn@u-blox.com

Support: support_cn@u-blox.com

Regional Office China (Shenzhen):

Phone: +86 755 8627 1083

E-mail: info_cn@u-blox.com

Support: support_cn@u-blox.com

Regional Office India:

Phone: +91 80 405 092 00

E-mail: info_in@u-blox.com

Support: support_in@u-blox.com

Regional Office Japan (Osaka):

Phone: +81 6 6941 3660

E-mail: info_jp@u-blox.com

Support: support_jp@u-blox.com

Regional Office Japan (Tokyo):

Phone: +81 3 5775 3850

E-mail: info_jp@u-blox.com

Support: support_jp@u-blox.com

Regional Office Korea:

Phone: +82 2 542 0861

E-mail: info_kr@u-blox.com

Support: support_kr@u-blox.com

Regional Office Taiwan:

Phone: +886 2 2657 1090

E-mail: info_tw@u-blox.com

Support: support_tw@u-blox.com