

# Image Reject Mixer

## 8 - 26 GHz



MAMX-011040

Rev. V2

### Features

- Passive Mixer—No Bias required
- Usable as IR Downconverter or as Single Sideband (SSB) Upconverter
- Wideband 8-26 GHz RF/LO range
- Low Conversion Loss: 8 dB
- Operates at low LO level of +10 dBm
- LO Power Operating Range: 10 - 18 dBm
- Nominal LO drive of +14 dBm
- High Linearity: 17 dBm IIP3
- High Image Rejection: 22 dBc
- Wide IF Bandwidth: DC to 4.0 GHz
- High Isolation
- Package Size: 4 mm QFN 24-lead
- RoHS\* Compliant

### Applications

- Test & Measurement, Microwave Radio, and Radar

### Description

MAMX-011040 is an image-reject passive diode mixer MMIC. The mixer offers low conversion loss, high linearity, high image rejection over wideband 8-26 GHz range, and wide IF bandwidth up to 4GHz. The nominal LO drive is +14 dBm. However, the MAMX-011040 exhibits excellent Conversion Loss and Image Rejection performance at 10dBm. The overall LO operating range is +10 dBm to +18 dBm. The image-reject circuit configuration provides excellent port isolation while internal 50-ohm matching simplifies its application.

### Ordering Information<sup>1,2</sup>

Part Number	Package
MAMX-011040	Bulk
MAMX-011040-TR0100	100 Piece Reel
MAMX-011040-TR0500	500 Piece Reel
MAMX-011040-SB1	Sample Board

1. Reference Application Note M513 for reel size information.
2. All sample boards include 5 loose parts.

### Functional Schematic

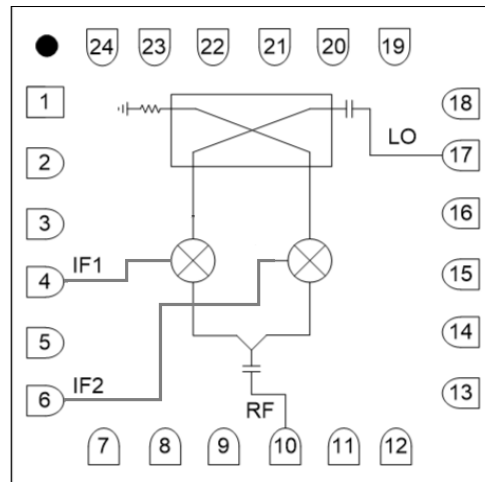

### Pin Configuration<sup>3</sup>

Pin #	Function
1 - 3	Ground
4	IF1
5	Ground
6	IF2
7 - 9	Ground
10	RF
11 - 16	Ground
17	LO
18 - 24	Ground
25	Paddle <sup>4</sup>

3. MACOM recommends connecting unused package pins to ground.
4. The exposed pad centered on the package bottom must be connected to RF, DC and thermal ground.

\* Restrictions on Hazardous Substances, compliant to current RoHS EU directive.

# Image Reject Mixer

## 8 - 26 GHz



MAMX-011040

Rev. V2

### Electrical Specifications<sup>5</sup>: $F_{IF} = 100 \text{ MHz}$ , $P_{LO} = +14 \text{ dBm}$ , $T_A = +25^\circ\text{C}$ , $Z_0 = 50 \Omega$

Parameter	Test Conditions	Units	Min.	Typ.	Max.
LO and RF Frequency	—	GHz	8	—	26
IF Frequency	—	GHz	0	—	4
LO Power	—	dBm	—	14	—
Conversion Loss	8 - 12 GHz 12 - 26 GHz	dB	—	8 9	9.5 11.5
Input P1dB	—	dBm	—	9	—
Input IP3	$P_{RF} = -10 \text{ dBm/tone}$ , $\Delta f = 1 \text{ MHz}$	dBm	—	17	—
Input IP2	—	dBm	—	40	—
LO-to-RF Isolation	—	dB	—	35	—
LO-to-IF Isolation	—	dB	—	35	—
RF-to-IF Isolation	—	dB	—	15	—
Image Rejection	—	dBc	17	22	—
Amplitude Imbalance	—	dB	—	$\pm 2.0$	—
Phase Imbalance	—	°	—	$\pm 10.0$	—
RF Return Loss	—	dB	—	6	—
IF Return Loss	—	dB	—	12	—

5. All specifications refer to down-conversion operation with upper sideband selected, unless otherwise noted.

### Absolute Maximum Ratings<sup>4,5</sup>

Parameter	Absolute Maximum
LO Power	+23 dBm
RF or IF Power	+20 dBm
Junction Temperature <sup>6</sup>	+150°C
Operating Temperature	-40°C to +85°C
Storage Temperature	-65°C to +150°C

- Exceeding any one or combination of these limits may cause permanent damage to this device.
- MACOM does not recommend sustained operation near these survivability limits.
- Operating at nominal conditions with  $T_J \leq +150^\circ\text{C}$  will ensure  $MTTF > 1 \times 10^6$  hours. Thermal resistance,  $\Theta_{JC}$  is  $85^\circ\text{C/W}$ .

### Handling Procedures

Please observe the following precautions to avoid damage:

### Static Sensitivity

These electronic devices are sensitive to electrostatic discharge (ESD) and can be damaged by static electricity. Proper ESD control techniques should be used when handling these HBM Class 1A devices.

### Assembly Information

- Do not subject the device to excessive force, especially at elevated temperatures  $>60^\circ\text{C}$ .
- No-clean flux is required for assembly. Post SMT washing is not recommended.

### Typical Performance Curves Lower Side Band (LSB) High Side LO at 100 MHz IF

**Down Conversion Gain over LO drive**  
Data captured with 90deg hybrid at 100MHz IF

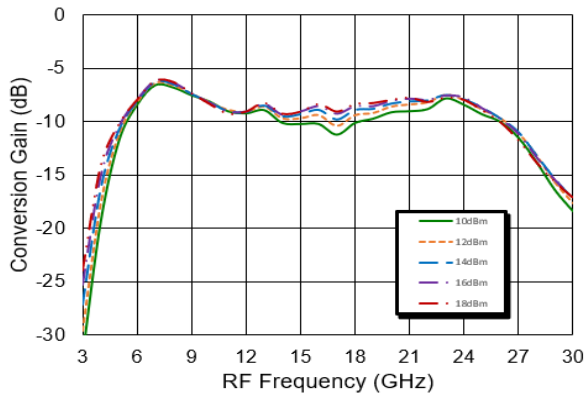

**Down Conversion Image Rejection over LO drive**  
Data captured with 90deg hybrid at 100MHz IF

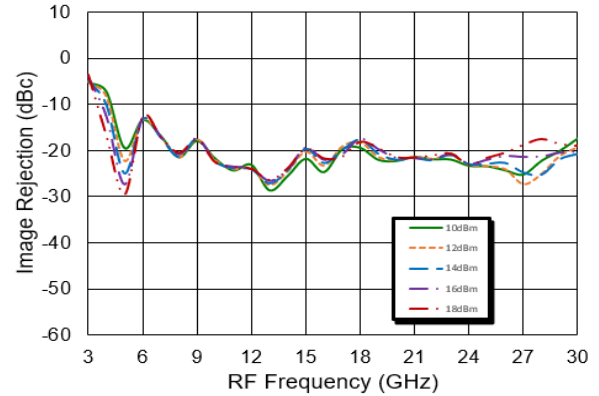

**IIP3 over LO drive**  
Data captured with 90deg hybrid at 100MHz IF

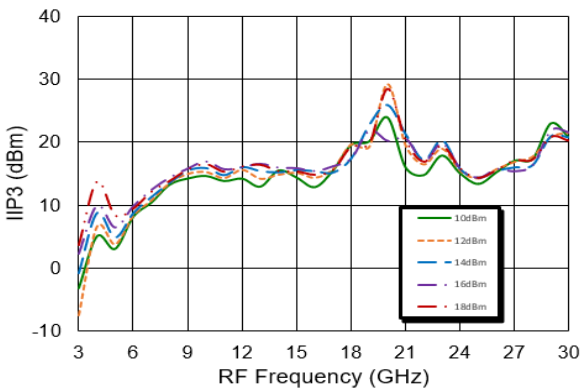

**IIP2 over LO drive**  
Data captured with 90deg hybrid at 100MHz IF

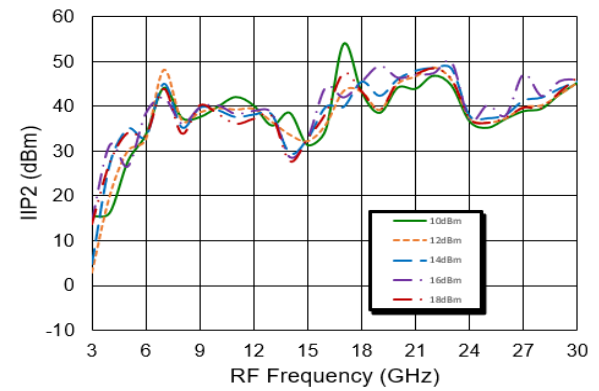

**Amplitude Imbalance over LO drive**

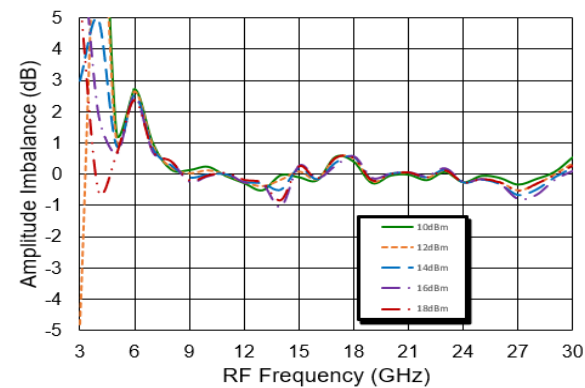

**Phase Imbalance over LO drive**

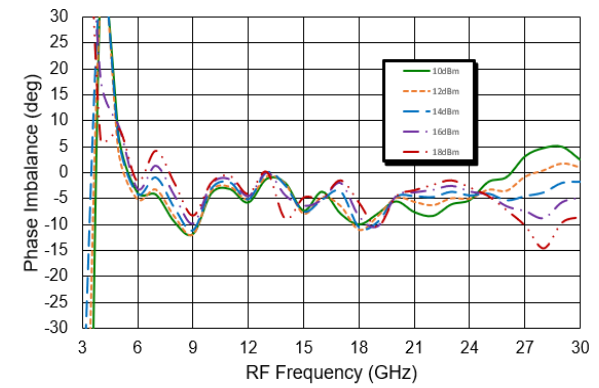

# Image Reject Mixer

## 8 - 26 GHz



MAMX-011040  
Rev. V2

### Typical Performance Curves Lower Side Band (LSB) High Side LO at 100 MHz IF

**Down Conversion Gain over temperature**  
Data captured with 90deg hybrid at 100MHz IF

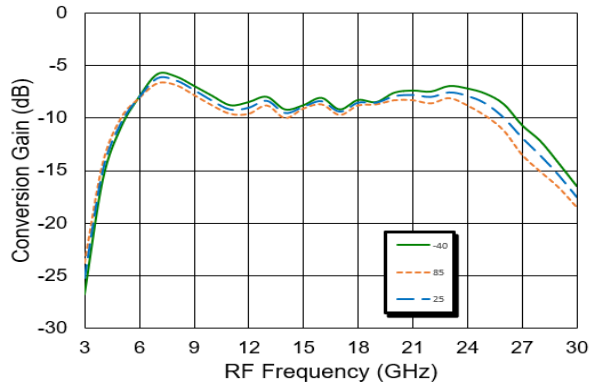

**Down Conversion Image Rejection over temperature**  
Data captured with 90deg hybrid at 100MHz IF

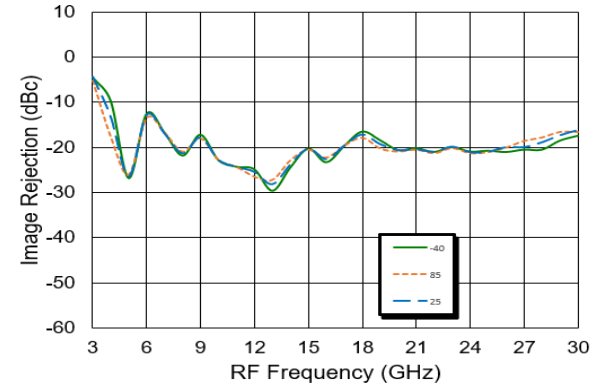

**IIP3 over temperature**  
Data captured with 90deg hybrid at 100MHz IF

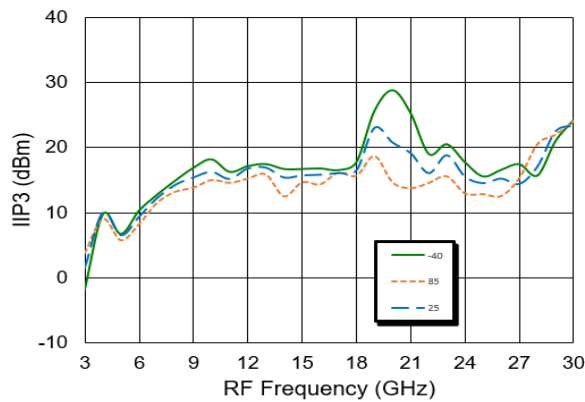

**IIP2 over temperature**  
Data captured with 90deg hybrid at 100MHz IF

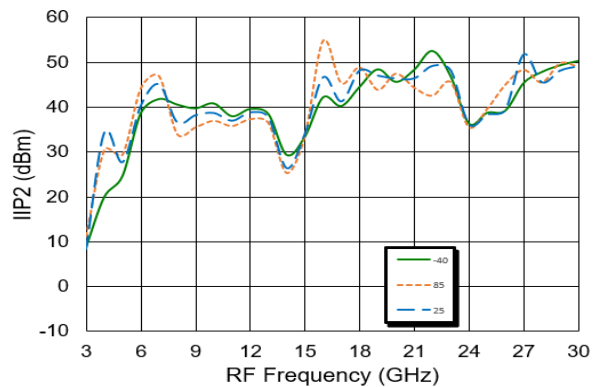

### Typical Performance Curves Upper Side Band (USB) Low Side LO at 100 MHz IF

*Down Conversion Gain over LO drive*

*Data captured with 90deg hybrid at 100MHz IF*

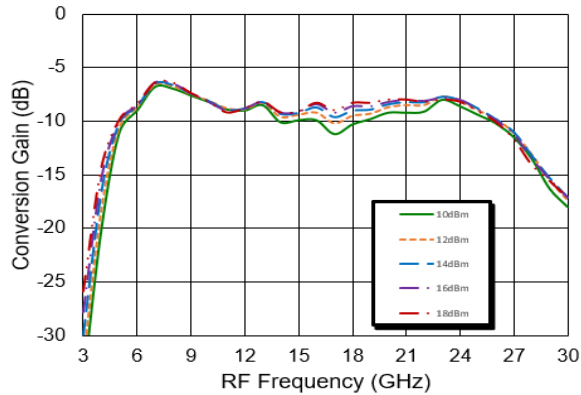

*Down Conversion Image Rejection over LO drive*

*Data captured with 90deg hybrid at 100MHz IF*

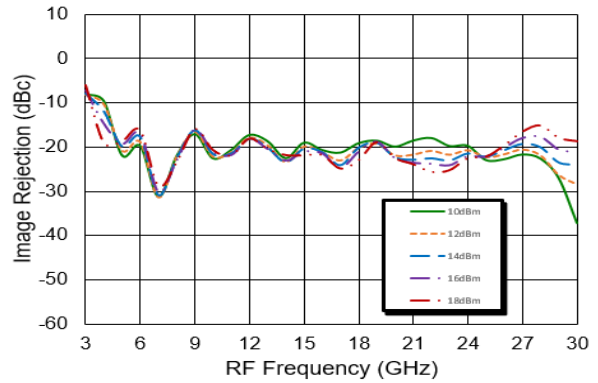

*IIP3 over LO drive*

*Data captured with 90deg hybrid at 100MHz IF*

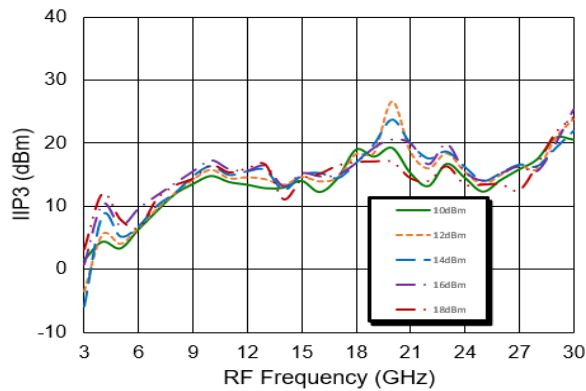

*IIP2 over LO drive*

*Data captured with 90deg hybrid at 100MHz IF*

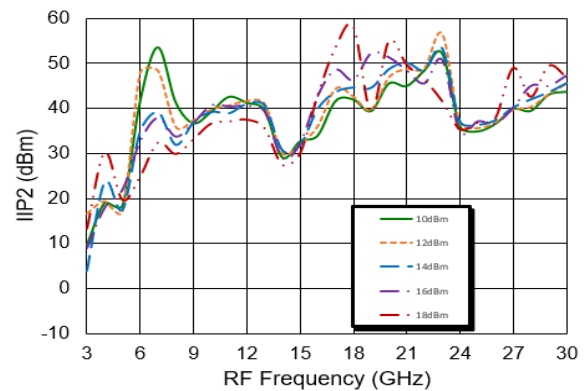

*Amplitude Imbalance over LO drive*

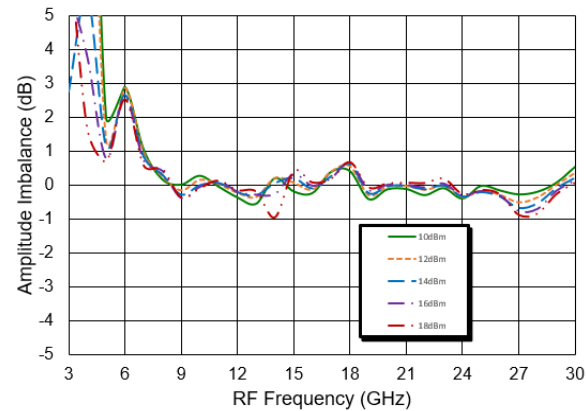

*Phase Imbalance over LO drive*

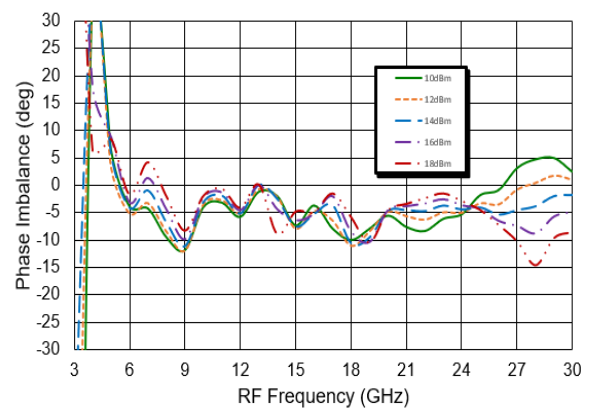

### Typical Performance Curves Upper Side Band (USB) Low Side LO at 100 MHz IF

**Down Conversion Gain over temperature**  
Data captured with 90deg hybrid at 100MHz IF

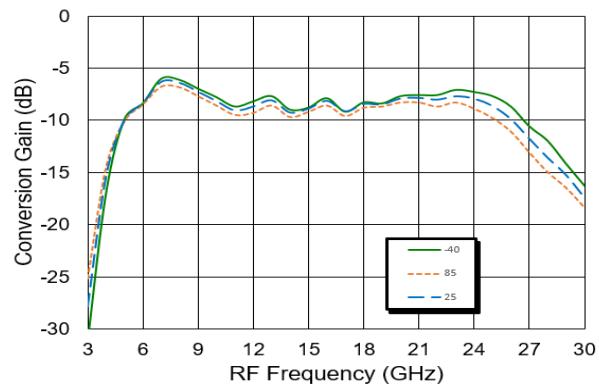

**Down Conversion Image Rejection over temperature**  
Data captured with 90deg hybrid at 100MHz IF

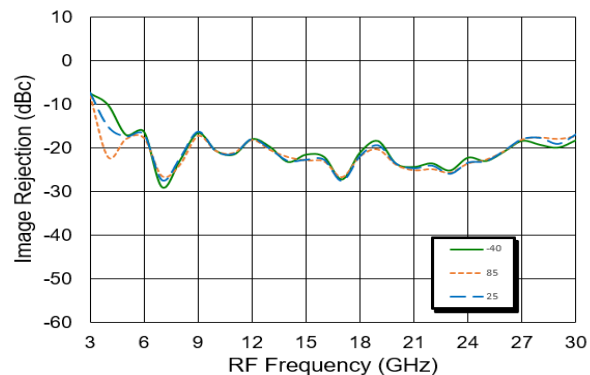

**IIP3 over temperature**  
Data captured with 90deg hybrid at 100MHz IF

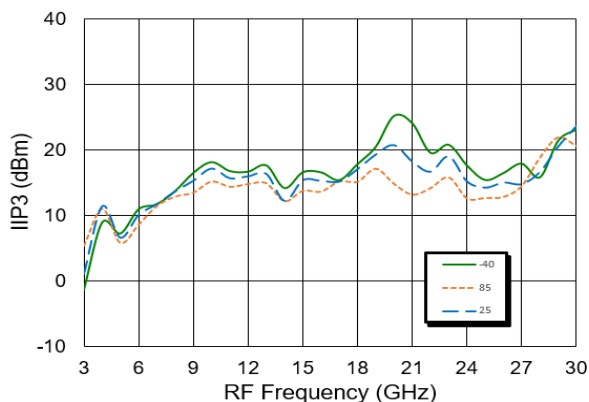

**IIP2 over temperature**  
Data captured with 90deg hybrid at 100MHz IF

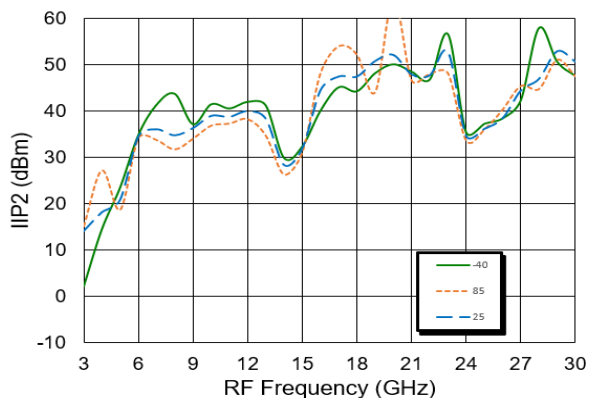

### Typical Performance Curves Lower Side Band (LSB) High Side LO at 100 MHz IF

**Up Conversion Gain over LO drive**  
Data captured with 90deg hybrid at 100MHz IF

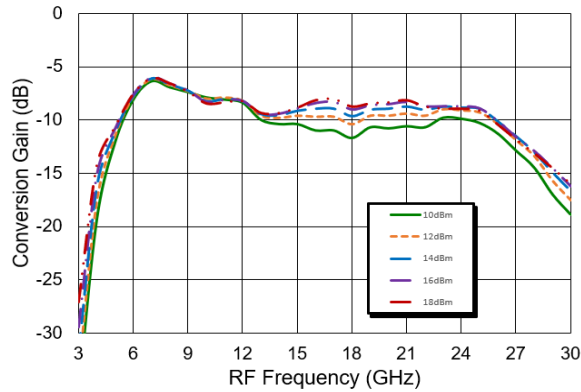

**Up Conversion SSB over LO drive**  
Data captured with 90deg hybrid at 100MHz IF

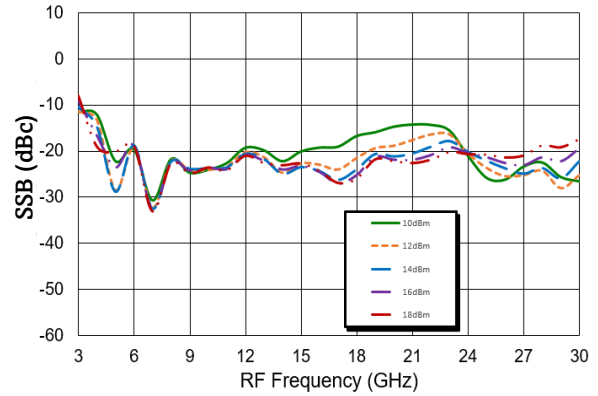

### Typical Performance Curves Upper Side Band (USB) Low Side LO

**Up Conversion Gain over LO drive**  
Data captured with 90deg hybrid at 100MHz IF

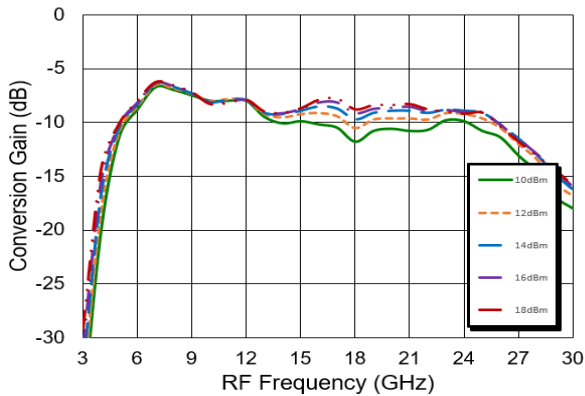

**Up Conversion SSB over LO drive**  
Data captured with 90deg hybrid at 100MHz IF

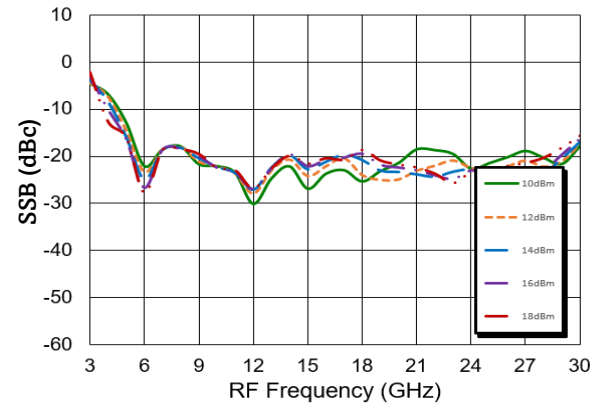

### Typical Performance Curves Lower Side Band (LSB) High Side LO at 2GHz IF

**Down Conversion Gain over LO drive**  
Data captured with 90deg hybrid at 2GHz IF

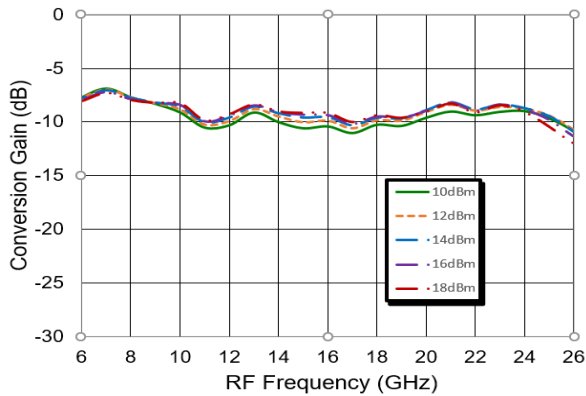

**Down Conversion Image Rejection over LO drive**  
Data captured with 90deg hybrid at 2GHz IF

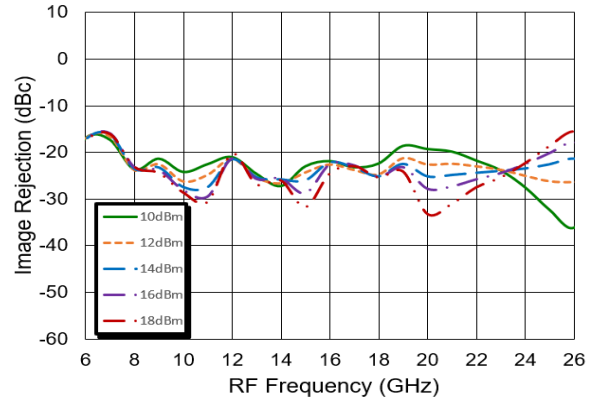

**IIP3 over LO drive**  
Data captured with 90deg hybrid at 2GHz IF

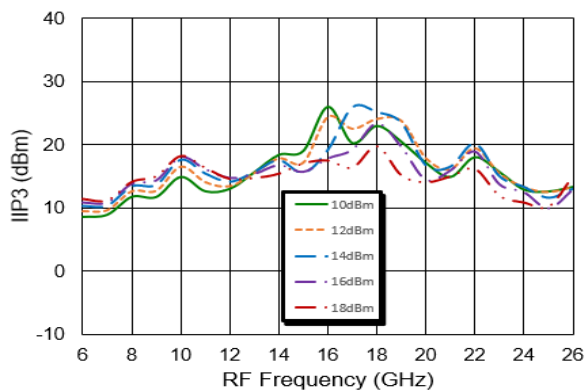

**IIP2 over LO drive**  
Data captured with 90deg hybrid at 2GHz IF

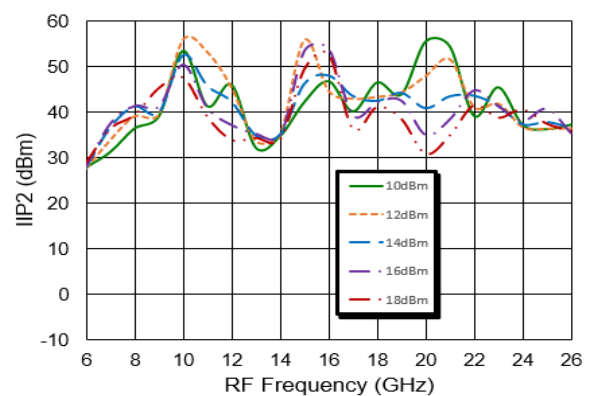



### Typical Performance Curves Lower Side Band (USB) Low Side LO at 2GHz IF

**Down Conversion Gain over LO drive**  
Data captured with 90deg hybrid at 2GHz IF

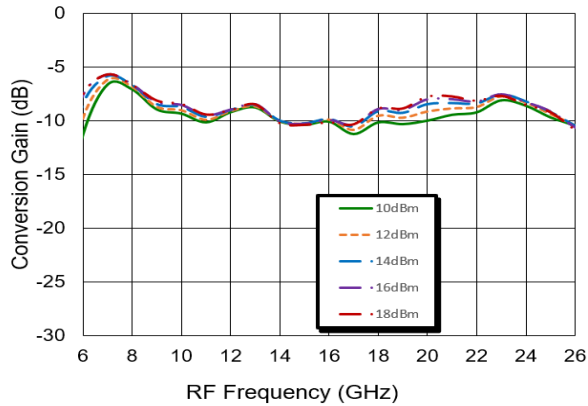

**Down Conversion Image Rejection over LO drive**  
Data captured with 90deg hybrid at 2GHz IF

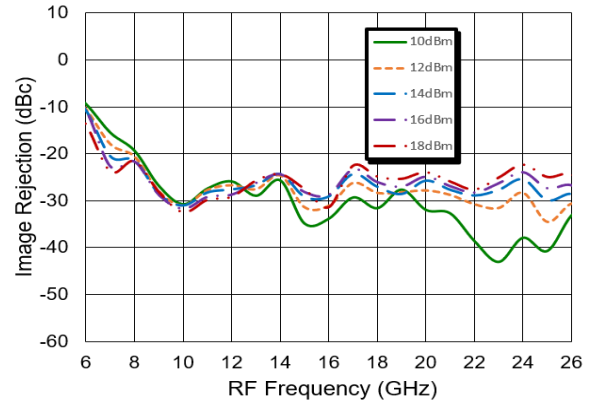

**IIP3 over LO drive**  
Data captured with 90deg hybrid at 2GHz IF

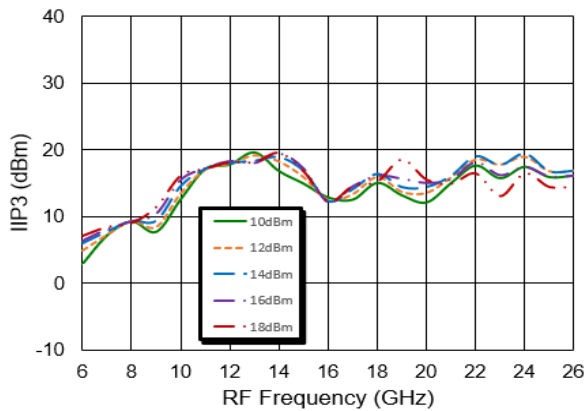

**IIP2 over LO drive**  
Data captured with 90deg hybrid at 2GHz IF

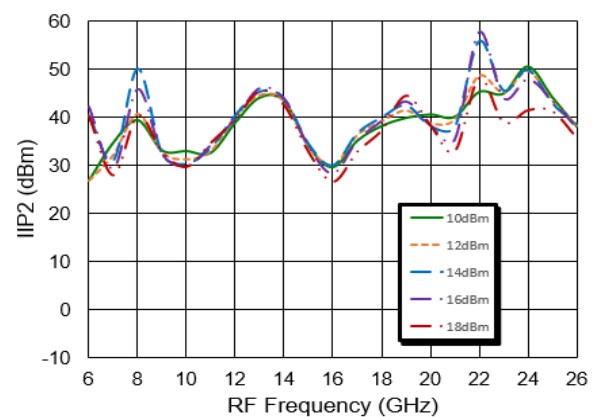

### Typical Performance Curves

**Isolations**

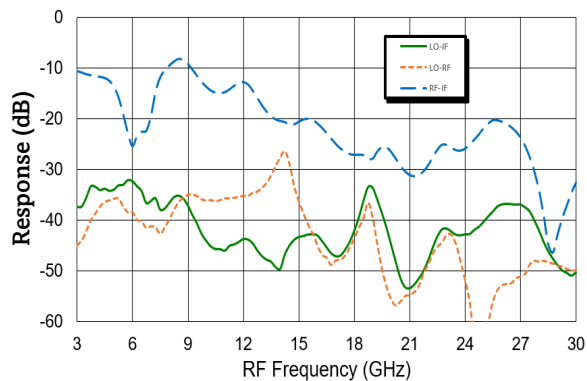

**IF Bandwidth**

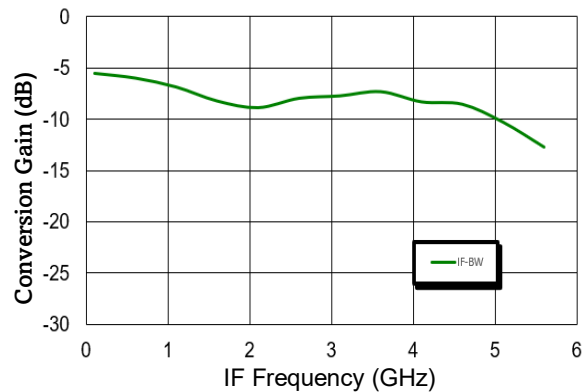

**RF Return Loss**

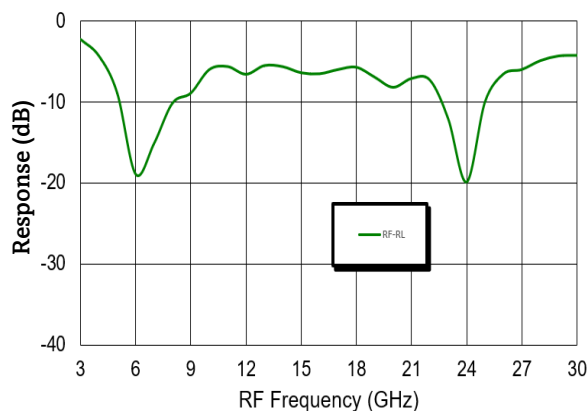

**P1dB vs LO power**

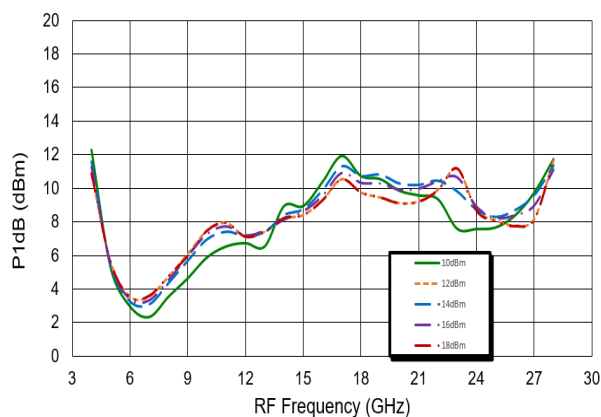

**IF Return Loss**

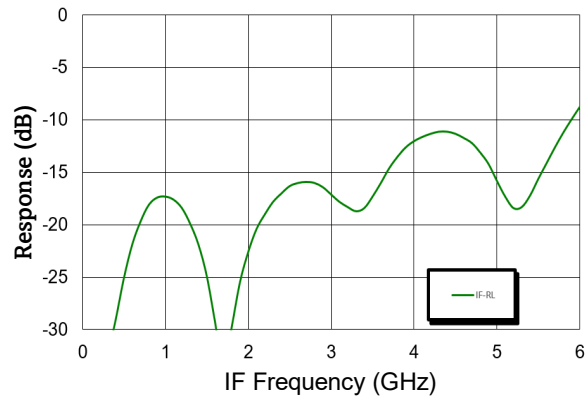

# Image Reject Mixer

## 8 - 26 GHz



MAMX-011040

Rev. V2

### MxN Spurious Rejection @ IF Port

RF 15.9 GHz at -10 dBm, LO 16 GHz at +14 dBm  
All values in dBc below the IF output power level

	nxLO				
mxRF	0	1	2	3	4
0	x	11	14	28	X
1	22	0	52	64.1	46
2	82	68	61	58.6	73
3	74.9	X	90	79	78
4	x	x	x	100.2	89.3

### LO Harmonics

LO +14 dBm  
Values in dBc below input LO level measured at RF

n LO spur at RF port				
LO GHz	1	2	3	4
6	37.9	46.1	60.8	50.2
8	46.6	53.9	51.9	59.1
10	42.3	56.6	51.2	51.4
12	37.9	56.6	81.2	38.2
14	30.4	52.1	47.8	N/A
16	42.8	52.1	47.8	N/A
18	42.6	83.3	N/A	N/A
20	55.4	52.6	N/A	N/A
22	39.9	54.4	N/A	N/A
24	52.7	53.6	N/A	N/A
26	N/A	N/A	N/A	N/A

### Sample Board

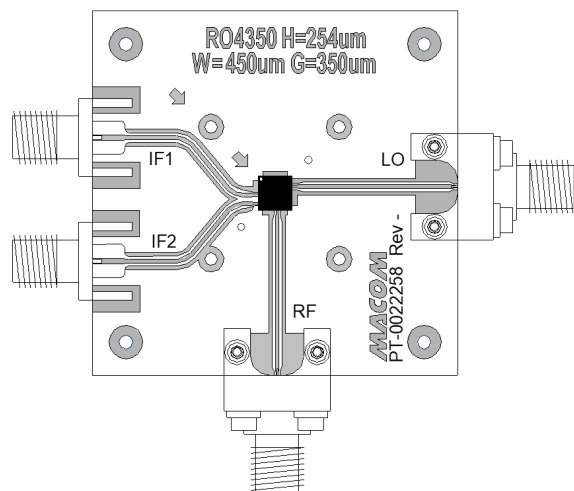

- Material: Rogers 4350B
- Dielectric thickness 0.254 mm
- Finished copper thickness 17 microns (0.5 oz) plated to 44 microns +/- 10 microns
- Finish both sides: ENIG, 0.05-0.15  $\mu\text{m}$  gold over 3-6  $\mu\text{m}$  nickel
- DXF available on request

### Application Schematic

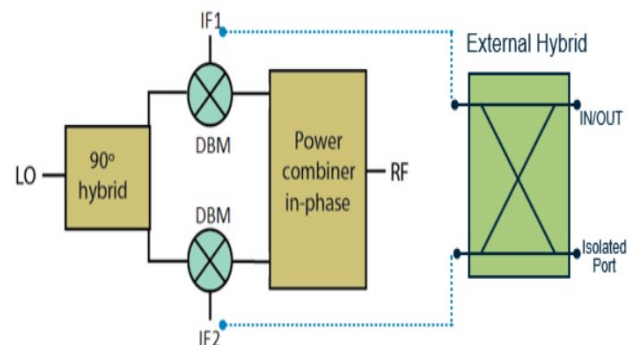

### External Hybrid

- Down conversion and Up conversion data captured with external hybrid 90° coupler part number: Innovative IPP-2345.
- RF Upper Side Band (USB) mode connect hybrid 0° port to IF1 mixer port, 90° hybrid port to IF2 mixer port.
- RF Lower Side Band (LSB) mode connect hybrid 0° port to IF2 mixer port, 90° hybrid port to IF1 mixer port.



MACOM Technology Solutions Inc. ("MACOM"). All rights reserved.

These materials are provided in connection with MACOM's products as a service to its customers and may be used for informational purposes only. Except as provided in its Terms and Conditions of Sale or any separate agreement, MACOM assumes no liability or responsibility whatsoever, including for (i) errors or omissions in these materials; (ii) failure to update these materials; or (iii) conflicts or incompatibilities arising from future changes to specifications and product descriptions, which MACOM may make at any time, without notice. These materials grant no license, express or implied, to any intellectual property rights.

THESE MATERIALS ARE PROVIDED "AS IS" WITH NO WARRANTY OR LIABILITY, EXPRESS OR IMPLIED, RELATING TO SALE AND/OR USE OF MACOM PRODUCTS INCLUDING FITNESS FOR A PARTICULAR PURPOSE, MERCHANTABILITY, INFRINGEMENT OF INTELLECTUAL PROPERTY RIGHT, ACCURACY OR COMPLETENESS, OR SPECIAL, INDIRECT, INCIDENTAL, OR CONSEQUENTIAL DAMAGES WHICH MAY RESULT FROM USE OF THESE MATERIALS.

MACOM products are not intended for use in medical, lifesaving or life sustaining applications. MACOM customers using or selling MACOM products for use in such applications do so at their own risk and agree to fully indemnify MACOM for any damages resulting from such improper use or sale.