

REGULATORY COMPLIANCE

 Lead Free COMPLIANT	 EU RoHS 2011/65 + 2015/863 COMPLIANT	 China RoHS COMPLIANT	 REACH SVHC COMPLIANT	 DRC CONFLICT FREE
--	--	--	--	--

ITEM DESCRIPTION

Quartz Crystal Resonator 2.5mm x 3.2mm x 0.8mm 4 Pad Ceramic Surface Mount (SMD)

ELECTRICAL SPECIFICATIONS

Nominal Frequency	10MHz to 54MHz
Frequency Tolerance/Stability	± 50 ppm at 25°C, ± 100 ppm over 0°C to +70°C ± 50 ppm at 25°C, ± 100 ppm over -20°C to +70°C ± 50 ppm at 25°C, ± 100 ppm over -40°C to +85°C ± 50 ppm at 25°C, ± 100 ppm over -40°C to +125°C ± 30 ppm at 25°C, ± 50 ppm over 0°C to +70°C ± 30 ppm at 25°C, ± 50 ppm over -20°C to +70°C ± 30 ppm at 25°C, ± 50 ppm over -40°C to +85°C ± 30 ppm at 25°C, ± 50 ppm over -40°C to +125°C ± 15 ppm at 25°C, ± 30 ppm over 0°C to +70°C ± 15 ppm at 25°C, ± 30 ppm over -20°C to +70°C ± 15 ppm at 25°C, ± 30 ppm over -40°C to +85°C ± 15 ppm at 25°C, ± 20 ppm over 0°C to +70°C ± 15 ppm at 25°C, ± 20 ppm over -20°C to +70°C ± 15 ppm at 25°C, ± 20 ppm over -40°C to +85°C ± 10 ppm at 25°C, ± 15 ppm over 0°C to +70°C ± 10 ppm at 25°C, ± 15 ppm over -20°C to +70°C ± 10 ppm at 25°C, ± 15 ppm over -40°C to +85°C (Only available over Nominal Frequency range of 12MHz to 54MHz) ± 10 ppm at 25°C, ± 10 ppm over 0°C to +70°C ± 10 ppm at 25°C, ± 10 ppm over -20°C to +70°C ± 10 ppm at 25°C, ± 10 ppm over -40°C to +85°C (Only available over Nominal Frequency range of 12MHz to 54MHz) ± 10 ppm at 25°C, ± 10 ppm over -30°C to +75°C (Only available over Nominal Frequency range of 20.000001MHz to 54MHz)
Aging at 25°C	± 3 ppm/year Maximum
Load Capacitance	Series Resonant, 8pF Parallel Resonant to 30pF Parallel Resonant
Shunt Capacitance	5pF Maximum
Equivalent Series Resistance	250 Ohms Maximum over Nominal Frequency of 10MHz to 11.999999MHz 150 Ohms Maximum over Nominal Frequency of 12MHz to 13.999999MHz 100 Ohms Maximum over Nominal Frequency of 14MHz to 15.999999MHz 80 Ohms Maximum over Nominal Frequency of 16MHz to 19.999999MHz 60 Ohms Maximum over Nominal Frequency of 20MHz to 29.999999MHz 50 Ohms Maximum over Nominal Frequency of 30MHz to 53.999999MHz 35 Ohms Maximum over Nominal Frequency of 54MHz to 54MHz
Mode of Operation	AT-Cut Fundamental
Drive Level	100 μ Watts Maximum
Crystal Cut	AT-Cut
Spurious Response	Measured from Fo to Fo +5000ppm -3dB Minimum
Storage Temperature Range	-40°C to +150°C
Insulation Resistance	Measured at 100Vdc 500 Megaohms Minimum

PART NUMBERING GUIDE

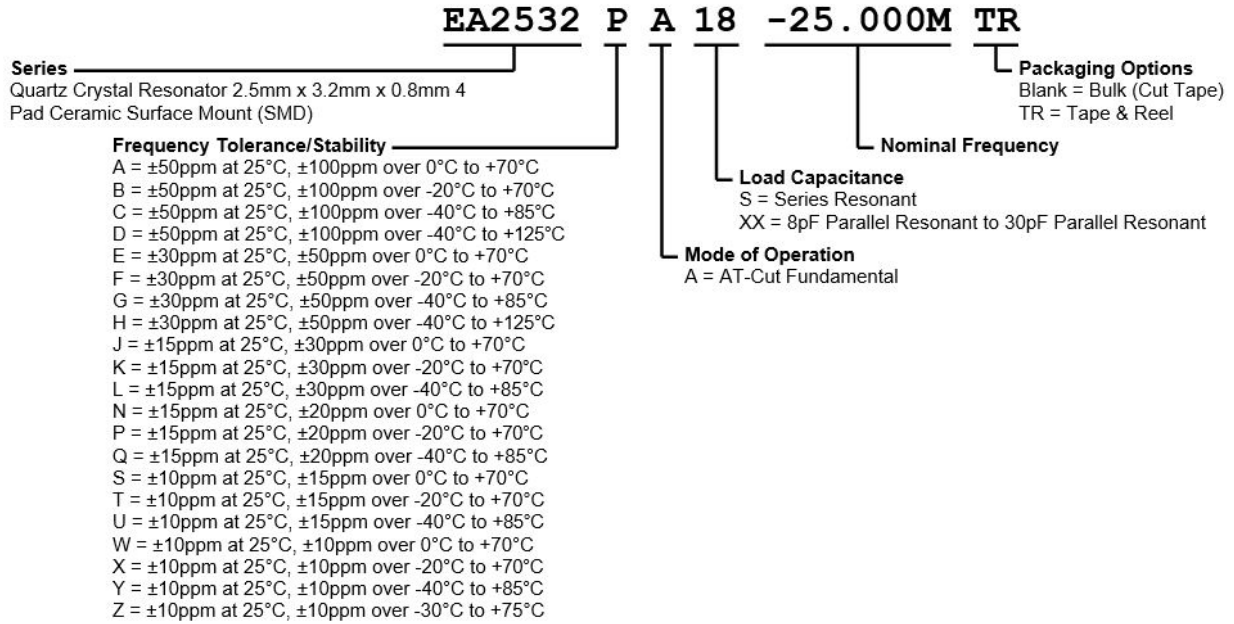

EA2532 Series

MECHANICAL DIMENSIONS

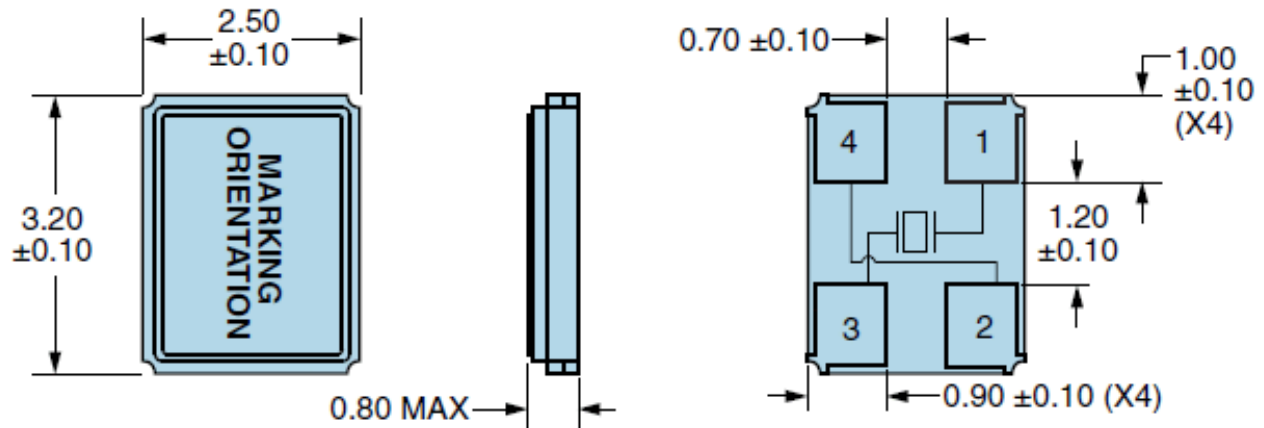

Note: Chamfer not shown.

Seam Sealed

Terminal Plating Thickness: Gold (0.3 to 1.0µm) over Nickel (1.27 to 8.89µm).

SUGGESTED SOLDER PAD LAYOUT

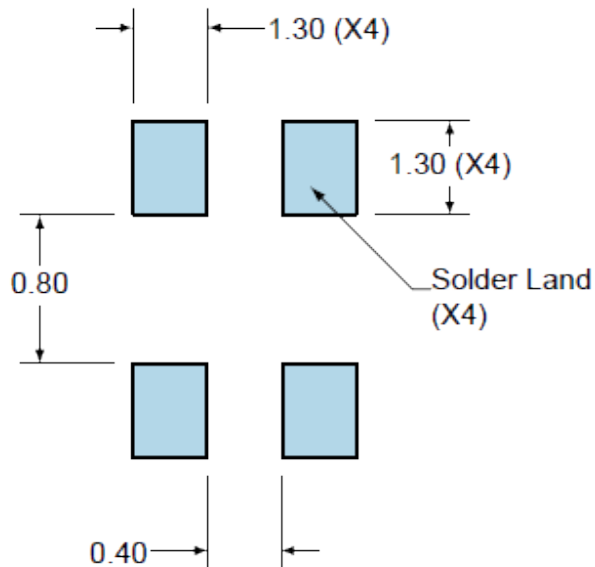

PIN	CONNECTION
1	Crystal
2	Cover/Ground
3	Crystal
4	Cover/Ground

All Tolerances are ±0.1

All Dimensions in Millimeters

TAPE & REEL DIMENSIONS

Quantity per Reel: 1,000 Units

All Dimensions in Millimeters

Compliant to EIA-481

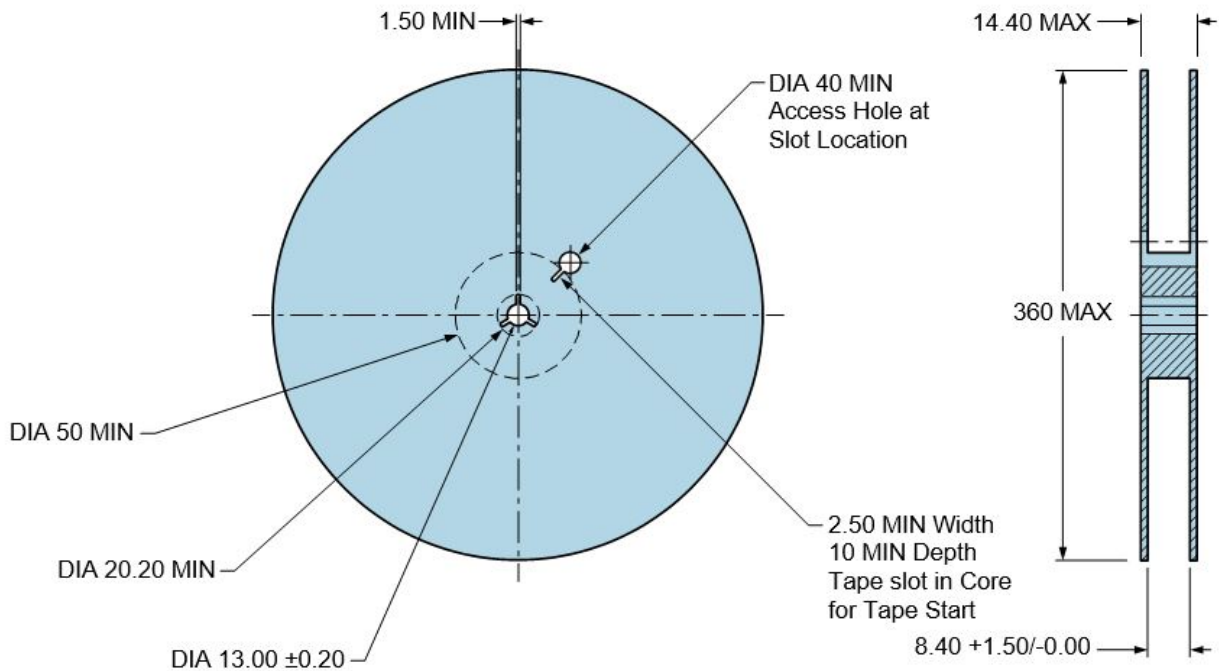
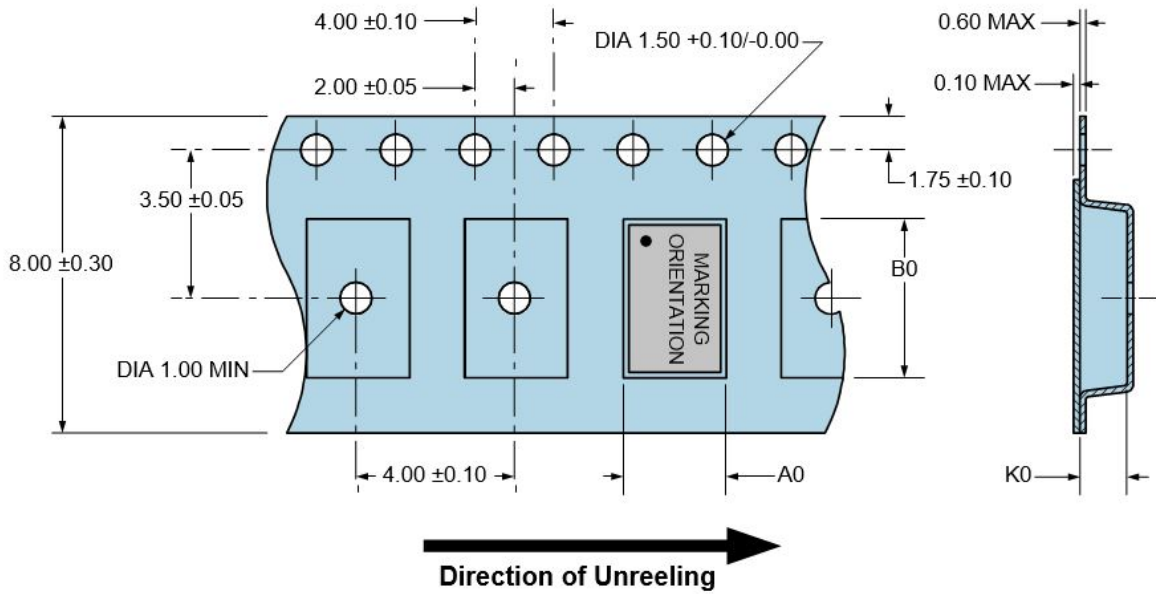

RECOMMENDED SOLDER REFLOW METHODS

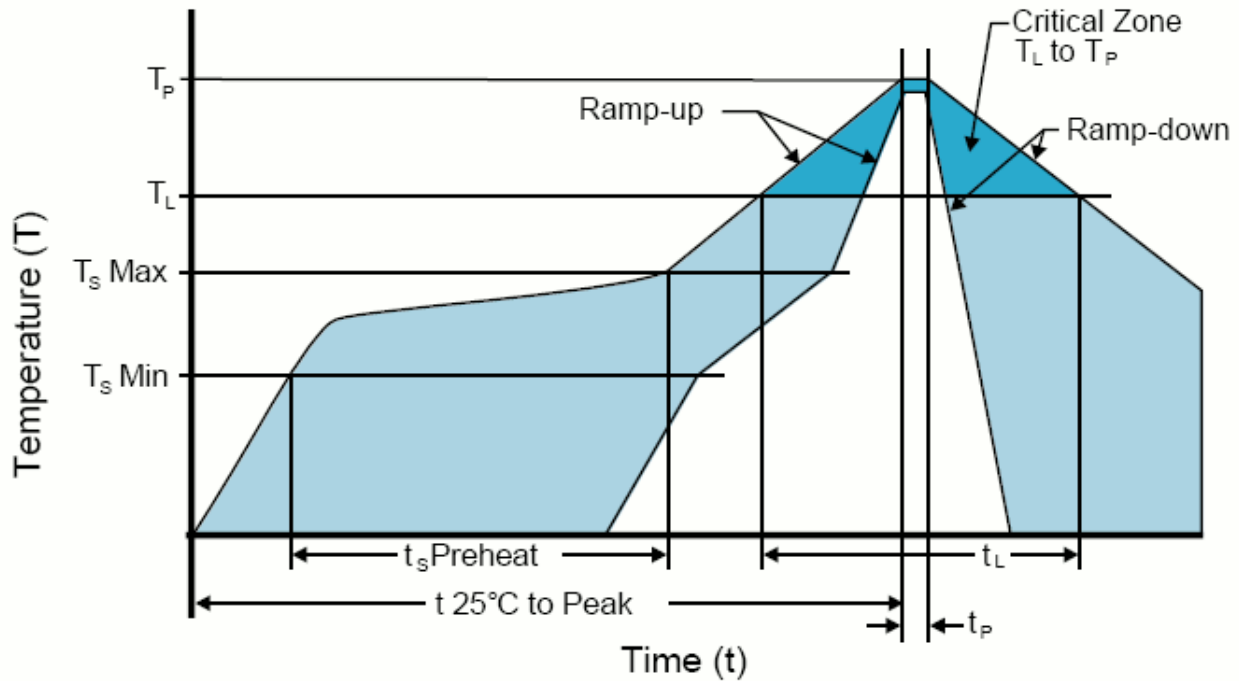

HIGH TEMPERATURE INFRARED/CONVECTION

T_S MAX to T_L (Ramp-up Rate)	3°C/Second Maximum
Preheat	
- Temperature Minimum (T_S MIN)	150°C
- Temperature Typical (T_S TYP)	175°C
- Temperature Maximum (T_S MAX)	200°C
- Time (t_s MIN)	60 - 180 Seconds
Ramp-up Rate (T_L to T_P)	3°C/Second Maximum
Time Maintained Above:	
- Temperature (T_L)	217°C
- Time (t_L)	60 - 150 Seconds
Peak Temperature (T_P)	260°C Maximum for 10 Seconds Maximum
Target Peak Temperature (T_P Target)	250°C +0/-5°C
Time within 5°C of actual peak (t_p)	20 - 40 Seconds
Ramp-down Rate	6°C/Second Maximum
Time 25°C to Peak Temperature (t)	8 Minutes Maximum
Moisture Sensitivity Level	Level 1
Additional Notes	Temperatures shown are applied to body of device.

High Temperature Manual Soldering

260°C Maximum for 5 Seconds Maximum, 2 times Maximum. (Temperatures shown are applied to body of device.)

RECOMMENDED SOLDER REFLOW METHODS

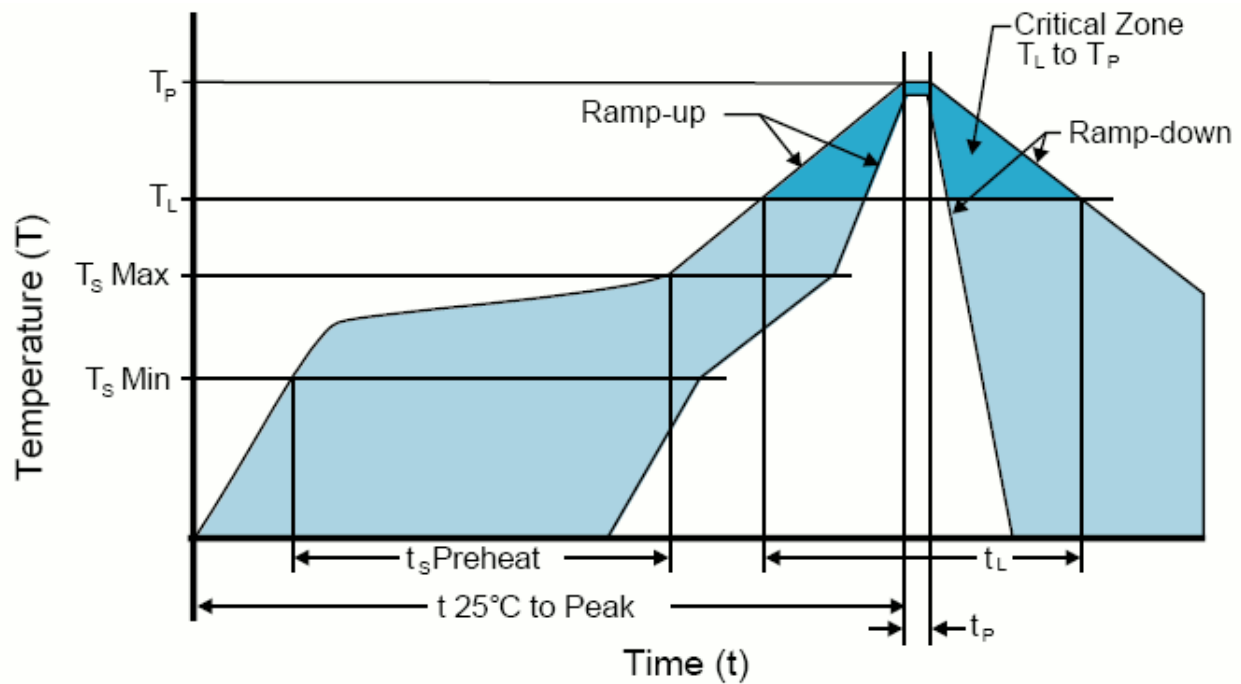

LOW TEMPERATURE INFRARED/CONVECTION

T_S MAX to T_L (Ramp-up Rate)	5°C/Second Maximum
Preheat	
- Temperature Minimum (T_S MIN)	N/A
- Temperature Typical (T_S TYP)	150°C
- Temperature Maximum (T_S MAX)	N/A
- Time (t_s MIN)	30 - 60 Seconds
Ramp-up Rate (T_L to T_P)	5°C/Second Maximum
Time Maintained Above:	
- Temperature (T_L)	150°C
- Time (t_L)	200 Seconds Maximum
Peak Temperature (T_P)	245°C Maximum
Target Peak Temperature (T_P Target)	245°C Maximum 2 Times / 230°C Maximum 1 Time
Time within 5°C of actual peak (t_P)	10 Seconds Maximum 2 Times / 80 Seconds Maximum 1 Time
Ramp-down Rate	5°C/Second Maximum
Time 25°C to Peak Temperature (t)	N/A
Moisture Sensitivity Level	Level 1
Additional Notes	Temperatures shown are applied to body of device.

Low Temperature Manual Soldering

185°C Maximum for 10 Seconds Maximum, 2 times Maximum. (Temperatures shown are applied to body of device.)