

# AMC1106x Small, High-Precision, Basic Isolated Delta-Sigma Modulators

## 1 Features

- $\pm 50$ -mV input voltage range optimized for current measurement with shunt resistors
- Manchester coded or uncoded bitstream options
- Excellent DC performance for high-precision sensing on system level:
  - Offset error and drift:  $\pm 50 \mu\text{V}$ ,  $\pm 1 \mu\text{V}/^\circ\text{C}$  (max)
  - Gain error and drift:  $\pm 0.2\%$ ,  $\pm 40 \text{ ppm}/^\circ\text{C}$  (max)
- 3.3-V operation for reduced power dissipation on both sides of the isolation barrier
- System-level diagnostic features
- High electromagnetic field immunity (see the [ISO72x Digital Isolator Magnetic-Field Immunity application report](#))
- Safety-related certifications:
  - 5657- $V_{\text{PK}}$  basic isolation per DIN VDE V 0884-11: 2017-01
  - 4000- $V_{\text{RMS}}$  isolation for 1 minute per UL1577
  - CAN/CSA No. 5A-component acceptance service notice and DIN EN 61010-1 end equipment standard

## 2 Applications

Shunt-resistor-based current sensing in 3-phase electricity meters

## 3 Description

The AMC1106 is a precision, delta-sigma ( $\Delta\Sigma$ ) modulator with the output separated from the input circuitry by a capacitive isolation barrier that is highly resistant to magnetic interference.

The input stage of the AMC1106 is optimized for direct connection to shunt resistors or other low voltage-level signal sources commonly used in multi-phase electricity meters to achieve excellent ac and dc performance. The device low input voltage range of  $\pm 50$ -mV allows use of small shunt resistor values to minimize power dissipation. Decimate the output bitstream of the AMC1106 with an appropriate digital filter. The [MSP430F67x](#), [TMS320F2807x](#), and [TMS320F2837x](#) microcontrollers, and the [AMC1210](#) integrate these digital filters for seamless operation with the AMC1106.

On the high-side, the modulator is supplied by a 3.3-V or 5-V power supply (AVDD). The isolated digital interface operates from a 3.0-V, 3.3-V, or 5-V power supply (DVDD).

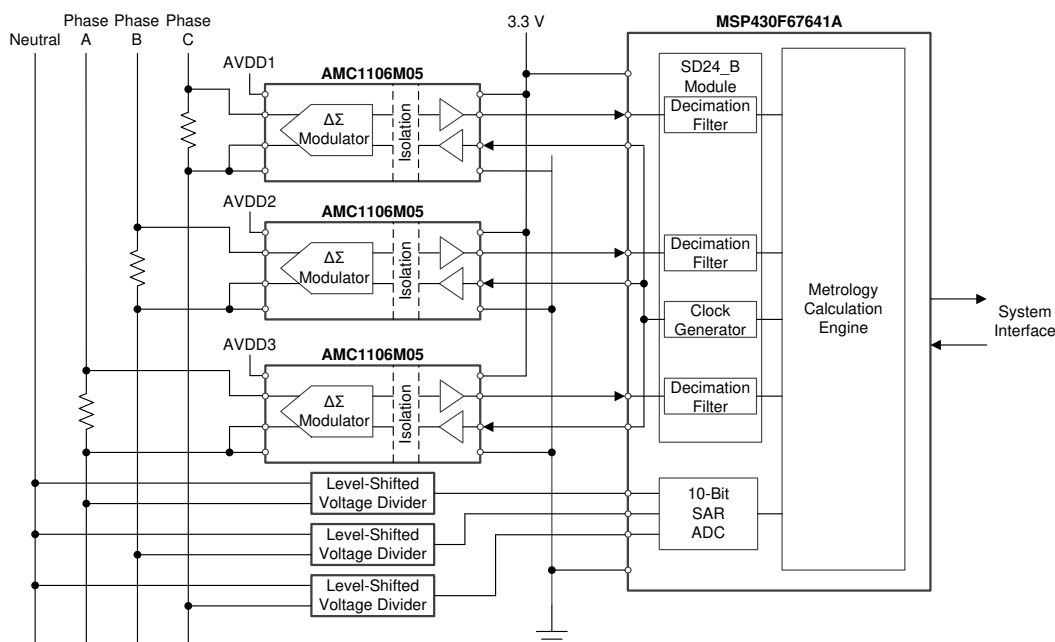
The AMC1106 is specified over the extended industrial temperature range of  $-40^\circ\text{C}$  to  $+125^\circ\text{C}$ .

### Device Information<sup>(1)</sup>

PART NUMBER	PACKAGE	BODY SIZE (NOM)
AMC1106x	SOIC (8)	5.85 mm x 7.50 mm

(1) For all available packages, see the orderable addendum at the end of the datasheet.

### Simplified Schematic



## Table of Contents

<b>1 Features</b> .....	<b>1</b>	8.1 Overview .....	<b>17</b>
<b>2 Applications</b> .....	<b>1</b>	8.2 Functional Block Diagram .....	<b>17</b>
<b>3 Description</b> .....	<b>1</b>	8.3 Feature Description .....	<b>18</b>
<b>4 Revision History</b> .....	<b>2</b>	8.4 Device Functional Modes .....	<b>22</b>
<b>5 Device Comparison Table</b> .....	<b>3</b>	<b>9 Application and Implementation</b> .....	<b>23</b>
<b>6 Pin Configuration and Functions</b> .....	<b>3</b>	9.1 Application Information .....	<b>23</b>
<b>7 Specifications</b> .....	<b>4</b>	9.2 Typical Application .....	<b>24</b>
7.1 Absolute Maximum Ratings .....	<b>4</b>	<b>10 Power Supply Recommendations</b> .....	<b>27</b>
7.2 ESD Ratings .....	<b>4</b>	<b>11 Layout</b> .....	<b>28</b>
7.3 Recommended Operating Conditions .....	<b>4</b>	11.1 Layout Guidelines .....	<b>28</b>
7.4 Thermal Information .....	<b>4</b>	11.2 Layout Example .....	<b>28</b>
7.5 Power Ratings .....	<b>4</b>	<b>12 Device and Documentation Support</b> .....	<b>29</b>
7.6 Insulation Specifications .....	<b>5</b>	12.1 Device Support .....	<b>29</b>
7.7 Safety-Related Certifications .....	<b>6</b>	12.2 Documentation Support .....	<b>29</b>
7.8 Safety Limiting Values .....	<b>6</b>	12.3 Related Links .....	<b>29</b>
7.9 Electrical Characteristics: AMC1106x .....	<b>7</b>	12.4 Receiving Notification of Documentation Updates .....	<b>29</b>
7.10 Timing Requirements .....	<b>9</b>	12.5 Support Resources .....	<b>29</b>
7.11 Switching Characteristics .....	<b>9</b>	12.6 Trademarks .....	<b>30</b>
7.12 Insulation Characteristics Curves .....	<b>10</b>	12.7 Electrostatic Discharge Caution .....	<b>30</b>
7.13 Typical Characteristics .....	<b>11</b>	12.8 Glossary .....	<b>30</b>
<b>8 Detailed Description</b> .....	<b>17</b>	<b>13 Mechanical, Packaging, and Orderable Information</b> .....	<b>30</b>

## 4 Revision History

NOTE: Page numbers for previous revisions may differ from page numbers in the current version.

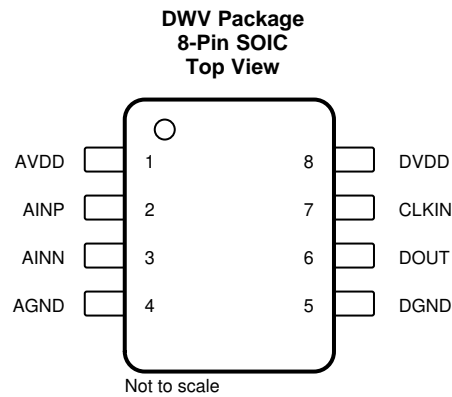
<b>Changes from Revision A (June 2018) to Revision B</b>	<b>Page</b>
• Changed safety-related certifications details as per ISO standard .....	<b>1</b>
• Changed CLR and CPG values from 9 mm to 8.5 mm in <i>Insulation Specifications</i> table .....	<b>5</b>
• Changed <i>Insulation Specifications</i> table per ISO standard .....	<b>5</b>
• Changed <i>Safety-Related Certification</i> table per ISO standard .....	<b>6</b>
• Changed <i>Safety Limiting Values</i> table format per latest standard .....	<b>6</b>

<b>Changes from Original (October 2017) to Revision A</b>	<b>Page</b>
• Changed test conditions of DTI parameter .....	<b>5</b>
• Changed test conditions of $V_{IOSM}$ parameter .....	<b>5</b>
• Changed test conditions of second $q_{pd}$ parameter row .....	<b>5</b>
• Changed test conditions of third $q_{pd}$ parameter row .....	<b>5</b>
• Changed VDE certification details in <i>Safety Related Certifications</i> table .....	<b>6</b>
• Changed <i>Block Diagram of an Isolation Channel</i> figure .....	<b>20</b>

## 5 Device Comparison Table

PART NUMBER	DIGITAL OUTPUT INTERFACE
AMC1106E05	Manchester coded CMOS
AMC1106M05	Uncoded CMOS

## 6 Pin Configuration and Functions



### Pin Functions

PIN		I/O	DESCRIPTION
NO.	NAME		
1	AVDD	—	Analog (high-side) power supply, 3.0 V to 5.5 V. See the <a href="#">Power Supply Recommendations</a> section for decoupling recommendations.
2	AINP	I	Noninverting analog input
3	AINN	I	Inverting analog input
4	AGND	—	Analog (high-side) ground reference
5	DGND	—	Digital (controller-side) ground reference
6	DOUT	O	Modulator data output. This pin is a Manchester coded output for the AMC1106E05.
7	CLKIN	I	Modulator clock input
8	DVDD	—	Digital (controller-side) power supply, 2.7 V to 5.5 V. See the <a href="#">Power Supply Recommendations</a> section for decoupling recommendations.

## 7 Specifications

### 7.1 Absolute Maximum Ratings

 see <sup>(1)</sup>

	MIN	MAX	UNIT
Supply voltage, AVDD to AGND or DVDD to DGND	-0.3	6.5	V
Analog input voltage at AINP, AINN	AGND – 6	AVDD + 0.5	V
Digital output voltage at DOUT, or digital input voltage on CLKIN	DGND – 0.5	DVDD + 0.5	V
Input current to any pin except supply pins	-10	10	mA
Junction temperature, T <sub>J</sub>		150	°C
Storage temperature, T <sub>stg</sub>	-65	150	°C

(1) Stresses beyond those listed under *Absolute Maximum Ratings* may cause permanent damage to the device. These are stress ratings only, which do not imply functional operation of the device at these or any other conditions beyond those indicated under *Recommended Operating Conditions*. Exposure to absolute-maximum-rated conditions for extended periods may affect device reliability.

### 7.2 ESD Ratings

			VALUE	UNIT
V <sub>(ESD)</sub>	Electrostatic discharge	Human-body model (HBM), per ANSI/ESDA/JEDEC JS-001 <sup>(1)</sup>	±2000	V
		Charged-device model (CDM), per JEDEC specification JESD22-C101 <sup>(2)</sup>	±1000	

(1) JEDEC document JEP155 states that 500-V HBM allows safe manufacturing with a standard ESD control process.

(2) JEDEC document JEP157 states that 250-V CDM allows safe manufacturing with a standard ESD control process.

### 7.3 Recommended Operating Conditions

over operating ambient temperature range (unless otherwise noted)

		MIN	NOM	MAX	UNIT
AVDD	Analog (high-side) supply voltage (AVDD to AGND)	3.0	5.0	5.5	V
DVDD	Digital (controller-side) supply voltage (DVDD to DGND)	2.7	3.3	5.5	V
T <sub>A</sub>	Operating ambient temperature	-40		125	°C

### 7.4 Thermal Information

THERMAL METRIC <sup>(1)</sup>		AMC1106x	UNIT
		DWV (SOIC)	
		8 PINS	
R <sub>θJA</sub>	Junction-to-ambient thermal resistance	112.2	°C/W
R <sub>θJC(top)</sub>	Junction-to-case (top) thermal resistance	47.6	°C/W
R <sub>θJB</sub>	Junction-to-board thermal resistance	60.0	°C/W
ψ <sub>JT</sub>	Junction-to-top characterization parameter	23.1	°C/W
ψ <sub>JB</sub>	Junction-to-board characterization parameter	60.0	°C/W
R <sub>θJC(bot)</sub>	Junction-to-case (bottom) thermal resistance	N/A	°C/W

(1) For more information about traditional and new thermal metrics, see the [Semiconductor and IC Package Thermal Metrics](#) application report.

### 7.5 Power Ratings

PARAMETER		TEST CONDITIONS	MIN	TYP	MAX	UNIT
P <sub>D</sub>	Maximum power dissipation (both sides)	AMC1106E05, AVDD = DVDD = 5.5 V			91.85	mW
		AMC1106M05, AVDD = DVDD = 5.5 V			86.90	
P <sub>D1</sub>	Maximum power dissipation (high-side supply)	AVDD = 5.5 V			53.90	mW
P <sub>D2</sub>	Maximum power dissipation (low-side supply)	AMC1106E05, AVDD = DVDD = 5.5 V			37.95	mW
		AMC1106M05, AVDD = DVDD = 5.5 V			33.00	

## 7.6 Insulation Specifications

over operating ambient temperature range (unless otherwise noted)

PARAMETER		TEST CONDITIONS	VALUE	UNIT
<b>GENERAL</b>				
CLR	External clearance <sup>(1)</sup>	Shortest pin-to-pin distance through air	≥ 8.5	mm
CPG	External creepage <sup>(1)</sup>	Shortest pin-to-pin distance across the package surface	≥ 8.5	mm
DTI	Distance through insulation	Minimum internal gap (internal clearance) of the insulation	≥ 0.021	mm
CTI	Comparative tracking index	DIN EN 60112 (VDE 0303-11); IEC 60112	≥ 600	V
	Material group	According to IEC 60664-1	I	
	Overvoltage category per IEC 60664-1	Rated mains voltage ≤ 300 V <sub>RMS</sub>	I-IV	
		Rated mains voltage ≤ 600 V <sub>RMS</sub>	I-IV	
<b>DIN VDE V 0884-11: 2017-01<sup>(2)</sup></b>				
V <sub>IORM</sub>	Maximum repetitive peak isolation voltage	At ac voltage (bipolar)	849	V <sub>PK</sub>
V <sub>IOWM</sub>	Maximum-rated isolation working voltage	At ac voltage (sine wave)	600	V <sub>RMS</sub>
		At dc voltage	849	V <sub>DC</sub>
V <sub>IOTM</sub>	Maximum transient isolation voltage	V <sub>TEST</sub> = V <sub>IOTM</sub> , t = 60 s (qualification test)	5657	V <sub>PK</sub>
		V <sub>TEST</sub> = 1.2 × V <sub>IOTM</sub> , t = 1 s (100% production test)	6789	
V <sub>IOSM</sub>	Maximum surge isolation voltage <sup>(3)</sup>	Test method per IEC 60065, 1.2/50-μs waveform, V <sub>TEST</sub> = 1.3 × V <sub>IOSM</sub> = 7800 V <sub>PK</sub> (qualification)	6000	V <sub>PK</sub>
q <sub>pd</sub>	Apparent charge <sup>(4)</sup>	Method a, after input/output safety test subgroup 2 / 3, V <sub>ini</sub> = V <sub>IOTM</sub> , t <sub>ini</sub> = 60 s, V <sub>pd(m)</sub> = 1.2 × V <sub>IORM</sub> = 1019 V <sub>PK</sub> , t <sub>m</sub> = 10 s	≤ 5	pC
		Method a, after environmental tests subgroup 1, V <sub>ini</sub> = V <sub>IOTM</sub> , t <sub>ini</sub> = 60 s, V <sub>pd(m)</sub> = 1.3 × V <sub>IORM</sub> = 1104 V <sub>PK</sub> , t <sub>m</sub> = 10 s	≤ 5	
		Method b1, at routine test (100% production) and preconditioning (type test), V <sub>ini</sub> = V <sub>IOTM</sub> , t <sub>ini</sub> = 1 s, V <sub>pd(m)</sub> = 1.5 × V <sub>IORM</sub> = 1274 V <sub>PK</sub> , t <sub>m</sub> = 1 s	≤ 5	
C <sub>IO</sub>	Barrier capacitance, input to output <sup>(5)</sup>	V <sub>IO</sub> = 0.5 V <sub>PP</sub> at 1 MHz	1.2	pF
R <sub>IO</sub>	Insulation resistance, input to output <sup>(5)</sup>	V <sub>IO</sub> = 500 V at T <sub>S</sub> = 150°C	> 10 <sup>9</sup>	Ω
	Pollution degree		2	
	Climatic category		40/125/21	
<b>UL1577</b>				
V <sub>ISO</sub>	Withstand isolation voltage	V <sub>TEST</sub> = V <sub>ISO</sub> = 4000 V <sub>RMS</sub> or 5657 V <sub>DC</sub> , t = 60 s (qualification), V <sub>TEST</sub> = 1.2 × V <sub>ISO</sub> = 4800 V <sub>RMS</sub> , t = 1 s (100% production test)	4000	V <sub>RMS</sub>

- (1) Apply creepage and clearance requirements according to the specific equipment isolation standards of an application. Care must be taken to maintain the creepage and clearance distance of a board design to ensure that the mounting pads of the isolator on the printed circuit board (PCB) do not reduce this distance. Creepage and clearance on a PCB become equal in certain cases. Techniques such as inserting grooves and ribs on the PCB are used to help increase these specifications.
- (2) This coupler is suitable for *safe electrical insulation* only within the safety ratings. Compliance with the safety ratings shall be ensured by means of suitable protective circuits.
- (3) Testing is carried out in air or oil to determine the intrinsic surge immunity of the isolation barrier.
- (4) Apparent charge is electrical discharge caused by a partial discharge (pd).
- (5) All pins on each side of the barrier are tied together, creating a two-pin device.

## 7.7 Safety-Related Certifications

VDE	UL
Certified according to DIN VDE V 0884-11: 2017-01 and DIN EN 61010-1 (VDE 0411-1): 2011-07	Recognized under 1577 component recognition and CSA component acceptance NO 5 programs
Basic insulation	Single protection
Certificate number: 40047657	File number: E181974

## 7.8 Safety Limiting Values

Safety limiting intends to minimize potential damage to the isolation barrier upon failure of input or output circuitry.

PARAMETER		TEST CONDITIONS	MIN	TYP	MAX	UNIT
I <sub>S</sub>	Safety input, output, or supply current, see <a href="#">Figure 3</a>	R <sub>θJA</sub> = 112.2°C/W, VDD1 = VDD2 = 5.5 V, T <sub>J</sub> = 150°C, T <sub>A</sub> = 25°C			202.5	mA
		R <sub>θJA</sub> = 112.2°C/W, VDD1 = VDD2 = 3.6 V, T <sub>J</sub> = 150°C, T <sub>A</sub> = 25°C			309.4	
P <sub>S</sub>	Safety input, output, or total power, see <a href="#">Figure 4</a>	R <sub>θJA</sub> = 112.2°C/W, T <sub>J</sub> = 150°C, T <sub>A</sub> = 25°C			1114 <sup>(1)</sup>	mW
T <sub>S</sub>	Maximum safety temperature				150	°C

- (1) The maximum safety temperature, T<sub>S</sub>, has the same value as the maximum junction temperature, T<sub>J</sub>, specified for the device. The I<sub>S</sub> and P<sub>S</sub> parameters represent the safety current and safety power, respectively. Do not exceed the maximum limits of I<sub>S</sub> and P<sub>S</sub>. These limits vary with the ambient temperature, T<sub>A</sub>.

The junction-to-air thermal resistance, R<sub>θJA</sub>, in the [Thermal Information](#) table is that of a device installed on a high-K test board for leaded surface-mount packages. Use these equations to calculate the value for each parameter:

$T_J = T_A + R_{\theta JA} \times P$ , where P is the power dissipated in the device.

$T_{J(max)} = T_S = T_A + R_{\theta JA} \times P_S$ , where T<sub>J(max)</sub> is the maximum junction temperature.

$P_S = I_S \times AVDD_{max} + I_S \times AVDD_{max}$ , where AVDD<sub>max</sub> is the maximum high-side supply voltage and DVDD<sub>max</sub> is the maximum controller-side supply voltage.

## 7.9 Electrical Characteristics: AMC1106x

minimum and maximum specifications apply from  $T_A = -40^\circ\text{C}$  to  $+125^\circ\text{C}$ ,  $AVDD = 3.0\text{ V}$  to  $5.5\text{ V}$ ,  $DVDD = 2.7\text{ V}$  to  $5.5\text{ V}$ ,  $AINP = -50\text{ mV}$  to  $50\text{ mV}$ ,  $AINN = AGND$ , and sinc<sup>3</sup> filter with OSR = 256 (unless otherwise noted); typical specifications are at  $T_A = 25^\circ\text{C}$ ,  $CLKIN = 20\text{ MHz}$ ,  $AVDD = 5\text{ V}$ , and  $DVDD = 3.3\text{ V}$

PARAMETER		TEST CONDITIONS	MIN	TYP	MAX	UNIT
<b>ANALOG INPUTS</b>						
$V_{Clipping}$	Differential input voltage before clipping output	$V_{IN} = AINP - AINN$		±64		mV
FSR	Specified linear differential full-scale	$V_{IN} = AINP - AINN$	-50		50	mV
	Absolute common-mode input voltage <sup>(1)</sup>	$(AINP + AINN) / 2$ to AGND	-2		AVDD	V
$V_{CM}$	Operating common-mode input voltage	$(AINP + AINN) / 2$ to AGND	-0.032		AVDD - 2.1	V
$V_{CMov}$	Common-mode overvoltage detection level <sup>(2)</sup>	$(AINP + AINN) / 2$ to AGND	AVDD - 2			V
$C_{IN}$	Single-ended input capacitance	$AINN = AGND$		4		pF
$C_{IND}$	Differential input capacitance			2		pF
$I_{IB}$	Input bias current	$AINP = AINN = AGND$ , $I_{IB} = I_{IBP} + I_{IBN}$	-97	-72	-57	µA
$R_{IN}$	Single-ended input resistance	$AINN = AGND$		4.75		kΩ
$R_{IND}$	Differential input resistance			4.9		kΩ
$I_{IO}$	Input offset current			±10		nA
CMTI	Common-mode transient immunity		15			kV/µs
CMRR	Common-mode rejection ratio	$AINP = AINN$ , $f_{IN} = 0\text{ Hz}$ , $V_{CM\ min} \leq V_{IN} \leq V_{CM\ max}$		-99		dB
		$AINP = AINN$ , $f_{IN}$ from 0.1 Hz to 50 kHz, $V_{CM\ min} \leq V_{IN} \leq V_{CM\ max}$		-98		
BW	Input bandwidth <sup>(3)</sup>			800		kHz
<b>DC ACCURACY</b>						
DNL	Differential nonlinearity	Resolution: 16 bits	-0.99		0.99	LSB
INL	Integral nonlinearity <sup>(4)</sup>	Resolution: 16 bits, $4.5\text{ V} \leq AVDD \leq 5.5\text{ V}$	-4	±1	4	LSB
		Resolution: 16 bits, $3.0\text{ V} \leq AVDD \leq 3.6\text{ V}$	-5	±1.5	5	
$E_O$	Offset error	Initial, at $25^\circ\text{C}$ , $AINP = AINN = AGND$	-50	±2.5	50	µV
$TCE_O$	Offset error thermal drift <sup>(5)</sup>		-1	±0.25	1	µV/°C
$E_G$	Gain error	Initial, at $25^\circ\text{C}$	-0.2%	±0.005%	0.2%	
$TCE_G$	Gain error thermal drift <sup>(6)</sup>		-40	±20	40	ppm/°C
PSRR	Power-supply rejection ratio	$AINP = AINN = AGND$ , $3.0\text{ V} \leq AVDD \leq 5.5\text{ V}$ , at dc		-108		dB
		$AINP = AINN = AGND$ , $3.0\text{ V} \leq AVDD \leq 5.5\text{ V}$ , 10 kHz, 100-mV ripple		-107		
<b>AC ACCURACY</b>						
SNR	Signal-to-noise ratio	$f_{IN} = 1\text{ kHz}$	78	82.5		dB
SINAD	Signal-to-noise + distortion	$f_{IN} = 1\text{ kHz}$	77.5	82.3		dB
THD	Total harmonic distortion	$4.5\text{ V} \leq AVDD \leq 5.5\text{ V}$ , $5\text{ MHz} \leq f_{CLKIN} \leq 21\text{ MHz}$ , $f_{IN} = 1\text{ kHz}$		-98	-84	dB
		$3.0\text{ V} \leq AVDD \leq 3.6\text{ V}$ , $5\text{ MHz} \leq f_{CLKIN} \leq 20\text{ MHz}$ , $f_{IN} = 1\text{ kHz}$		-93	-83	
SFDR	Spurious-free dynamic range	$f_{IN} = 1\text{ kHz}$	83	100		dB

- Steady-state voltage supported by the device in case of a system failure. See the specified common-mode input voltage  $V_{CM}$  for normal operation. Observe the analog input voltage range as specified in the [Absolute Maximum Ratings](#) table.
- The common-mode overvoltage detection level has a typical hysteresis of 90 mV.
- This parameter is the -3-dB, second-order, roll-off frequency of the integrated differential input amplifier to consider for antialiasing filter designs.
- Integral nonlinearity is defined as the maximum deviation from a straight line passing through the end-points of the ideal ADC transfer function expressed as a number of LSBs or as a percent of the specified linear full-scale range (FSR).
- Offset error drift is calculated using the box method, as described by the following equation:

$$TCE_O = \frac{value_{MAX} - value_{MIN}}{TempRange}$$

- Gain error drift is calculated using the box method, as described by the following equation:

$$TCE_G (ppm) = \left( \frac{value_{MAX} - value_{MIN}}{value \times TempRange} \right) \times 10^6$$

**Electrical Characteristics: AMC1106x (continued)**

minimum and maximum specifications apply from  $T_A = -40^\circ\text{C}$  to  $+125^\circ\text{C}$ ,  $AVDD = 3.0\text{ V}$  to  $5.5\text{ V}$ ,  $DVDD = 2.7\text{ V}$  to  $5.5\text{ V}$ ,  $A\text{INP} = -50\text{ mV}$  to  $50\text{ mV}$ ,  $A\text{INN} = \text{AGND}$ , and sinc<sup>3</sup> filter with  $\text{OSR} = 256$  (unless otherwise noted); typical specifications are at  $T_A = 25^\circ\text{C}$ ,  $\text{CLKIN} = 20\text{ MHz}$ ,  $AVDD = 5\text{ V}$ , and  $DVDD = 3.3\text{ V}$

PARAMETER		TEST CONDITIONS	MIN	TYP	MAX	UNIT
<b>DIGITAL INPUTS/OUTPUTS (CMOS Logic With Schmitt-Trigger)</b>						
$I_{\text{IN}}$	Input current	$\text{DGND} \leq V_{\text{CLKIN}} \leq \text{DVDD}$	0		7	$\mu\text{A}$
$C_{\text{IN}}$	Input capacitance			4		$\text{pF}$
$V_{\text{IH}}$	High-level input voltage		$0.7 \times \text{DVDD}$		$\text{DVDD} + 0.3$	$\text{V}$
$V_{\text{IL}}$	Low-level input voltage		-0.3		$0.3 \times \text{DVDD}$	$\text{V}$
$V_{\text{OH}}$	High-level output voltage	$I_{\text{OH}} = -20\ \mu\text{A}$	$\text{DVDD} - 0.1$			$\text{V}$
		$I_{\text{OH}} = -4\ \text{mA}$	$\text{DVDD} - 0.4$			
$V_{\text{OL}}$	Low-level output voltage	$I_{\text{OL}} = 20\ \mu\text{A}$			0.1	$\text{V}$
		$I_{\text{OL}} = 4\ \text{mA}$			0.4	
$C_{\text{LOAD}}$	Output load capacitance			30		$\text{pF}$
<b>POWER SUPPLY</b>						
$I_{\text{AVDD}}$	High-side supply current	$3.0\ \text{V} \leq \text{AVDD} \leq 3.6\ \text{V}$		6.3	8.5	$\text{mA}$
		$4.5\ \text{V} \leq \text{AVDD} \leq 5.5\ \text{V}$		7.2	9.8	
$I_{\text{DVDD}}$	Controller-side supply current	AMC1106E05, $2.7\ \text{V} \leq \text{DVDD} \leq 3.6\ \text{V}$ , $C_{\text{LOAD}} = 15\ \text{pF}$		4.1	5.5	$\text{mA}$
		AMC1106M05, $2.7\ \text{V} \leq \text{DVDD} \leq 3.6\ \text{V}$ , $C_{\text{LOAD}} = 15\ \text{pF}$		3.3	4.8	
		AMC1106E05, $4.5\ \text{V} \leq \text{DVDD} \leq 5.5\ \text{V}$ , $C_{\text{LOAD}} = 15\ \text{pF}$		5.0	6.9	
		AMC1106M05, $4.5\ \text{V} \leq \text{DVDD} \leq 5.5\ \text{V}$ , $C_{\text{LOAD}} = 15\ \text{pF}$		3.9	6.0	



## 7.10 Timing Requirements

over operating ambient temperature range (unless otherwise noted)

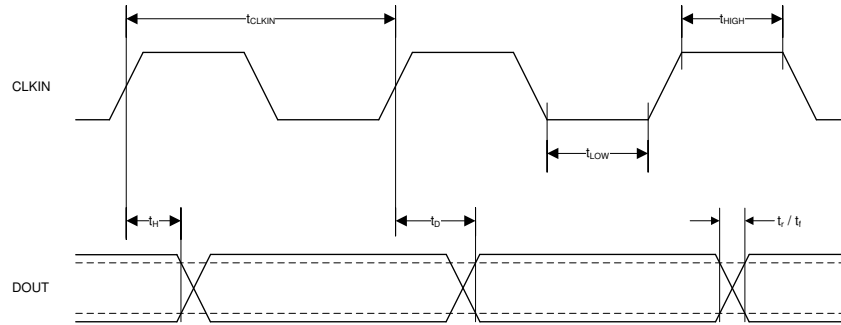
			MIN	NOM	MAX	UNIT
f <sub>CLKIN</sub>	CLKIN clock frequency	4.5 V ≤ AVDD ≤ 5.5 V	5		21	MHz
		3.0 V ≤ AVDD ≤ 5.5 V	5		20	
t <sub>CLKIN</sub>	CLKIN clock period, see <a href="#">Figure 1</a>	4.5 V ≤ AVDD ≤ 5.5 V	47.6		200	ns
		3.0 V ≤ AVDD ≤ 5.5 V	50		200	
t <sub>HIGH</sub>	CLKIN clock high time, see <a href="#">Figure 1</a>		20	25	120	ns
t <sub>LOW</sub>	CLKIN clock low time, see <a href="#">Figure 1</a>		20	25	120	ns

## 7.11 Switching Characteristics

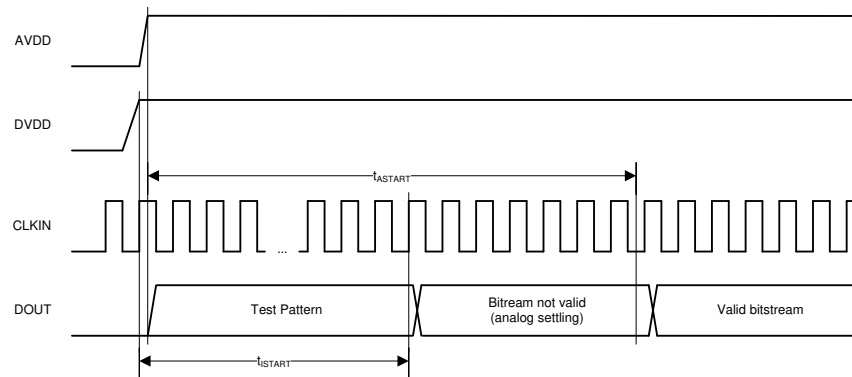
over operating ambient temperature range (unless otherwise noted)

PARAMETER		TEST CONDITIONS	MIN	TYP	MAX	UNIT
t <sub>H</sub>	DOUT hold time after rising edge of CLKIN, see <a href="#">Figure 1</a>	AMC1106M05 <sup>(1)</sup> , C <sub>LOAD</sub> = 15 pF	3.5			ns
t <sub>D</sub>	Rising edge of CLKIN to DOUT valid delay, see <a href="#">Figure 1</a>	AMC1106M05 <sup>(1)</sup> , C <sub>LOAD</sub> = 15 pF			15	ns
t <sub>r</sub>	DOUT rise time, see <a href="#">Figure 1</a>	10% to 90%, 2.7 V ≤ DVDD ≤ 3.6 V, C <sub>LOAD</sub> = 15 pF		0.8	3.5	ns
		10% to 90%, 4.5 V ≤ DVDD ≤ 5.5 V, C <sub>LOAD</sub> = 15 pF		1.8	3.9	
t <sub>f</sub>	DOUT fall time, see <a href="#">Figure 1</a>	90% to 10%, 2.7 V ≤ DVDD ≤ 3.6 V, C <sub>LOAD</sub> = 15 pF		0.8	3.5	ns
		90% to 10%, 4.5 V ≤ DVDD ≤ 5.5 V, C <sub>LOAD</sub> = 15 pF		1.8	3.9	
t <sub>START</sub>	Interface startup time, see <a href="#">Figure 2</a>	DVDD at 2.7 V (min) to DOUT valid with AVDD ≥ 3.0 V	32		32	t <sub>CLKIN</sub>
t <sub>ASTART</sub>	Analog startup time, see <a href="#">Figure 2</a>	AVDD step to 3.0 V with DVDD ≥ 2.7 V, 0.1% settling		0.5		ms

- (1) The output of the Manchester encoded versions of the AMC1106E05 can change with every edge of CLKIN with a typical delay of 6 ns; see the [Manchester Coding Feature](#) section for additional details.

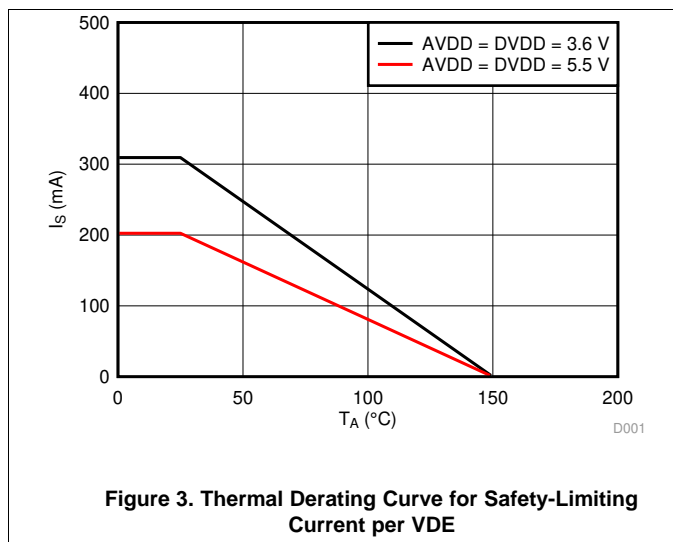


**Figure 1. Digital Interface Timing**

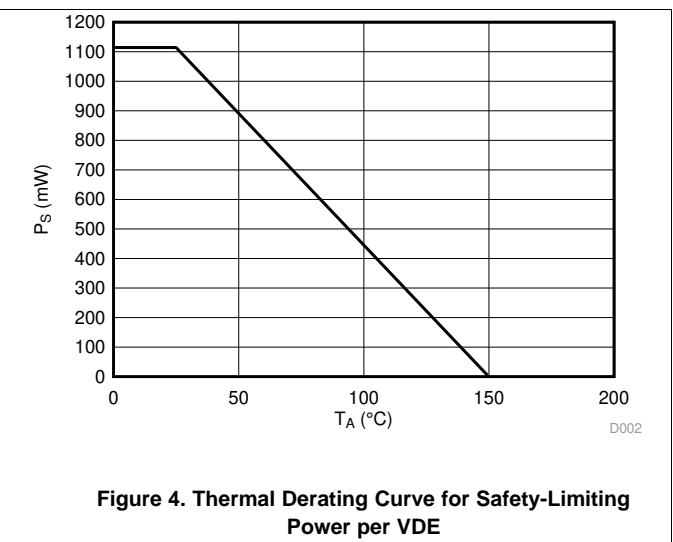


**Figure 2. Device Startup Timing**

**7.12 Insulation Characteristics Curves**



**Figure 3. Thermal Derating Curve for Safety-Limiting Current per VDE**



**Figure 4. Thermal Derating Curve for Safety-Limiting Power per VDE**

### 7.13 Typical Characteristics

at  $T_A = 25^\circ\text{C}$ ,  $AVDD = 5\text{ V}$ ,  $DVDD = 3.3\text{ V}$ ,  $AINP = -50\text{ mV}$  to  $50\text{ mV}$ ,  $AINN = AGND$ ,  $f_{CLKIN} = 20\text{ MHz}$ , and sinc<sup>3</sup> filter with  $OSR = 256$  (unless otherwise noted)

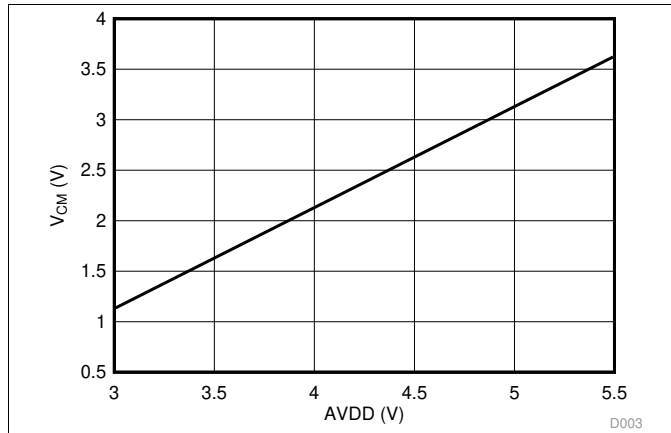


Figure 5. Maximum Operating Common-Mode Input Voltage vs High-Side Supply Voltage

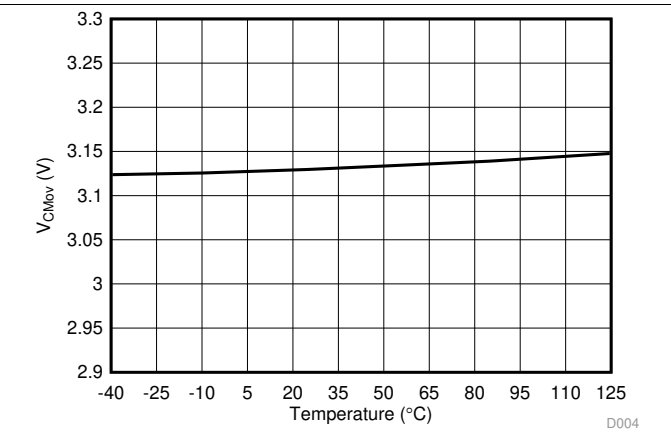


Figure 6. Common-Mode Overvoltage Detection Level vs Temperature

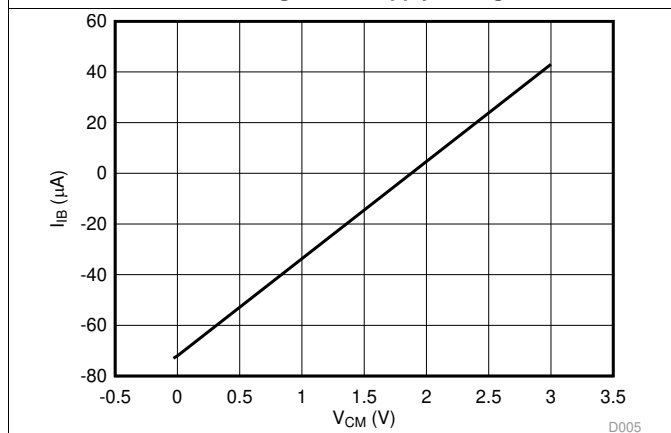


Figure 7. Input Bias Current vs Common-Mode Input Voltage

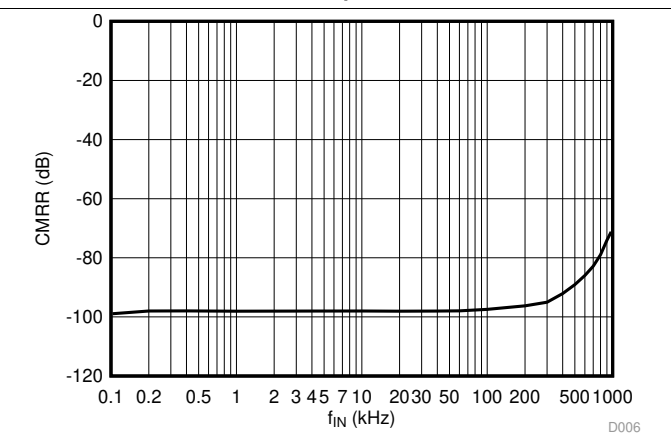


Figure 8. Common-Mode Rejection Ratio vs Input Signal Frequency

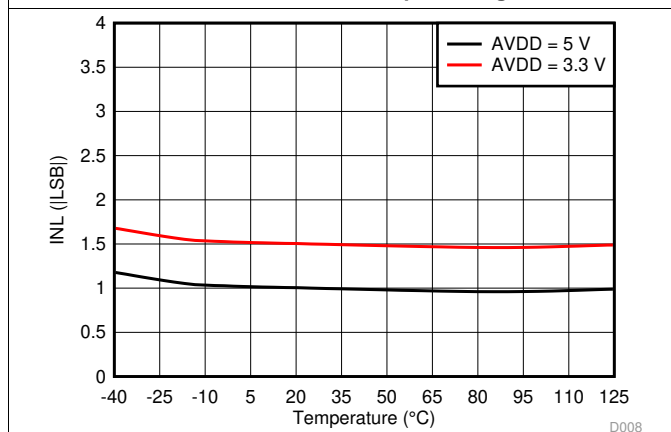


Figure 9. Integral Nonlinearity vs Temperature

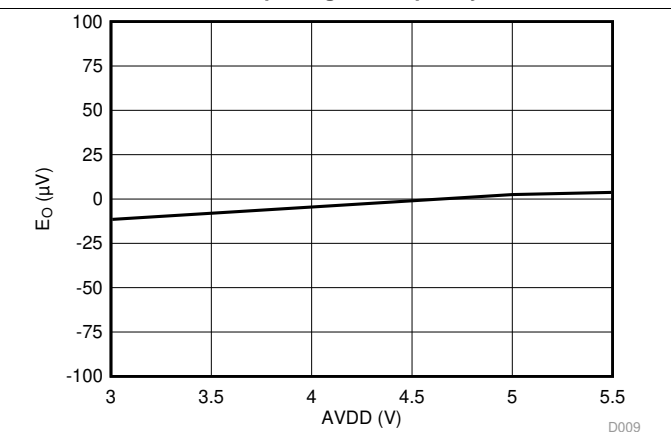


Figure 10. Offset Error vs High-Side Supply Voltage

### Typical Characteristics (continued)

at  $T_A = 25^\circ\text{C}$ ,  $AVDD = 5\text{ V}$ ,  $DVDD = 3.3\text{ V}$ ,  $AINP = -50\text{ mV to }50\text{ mV}$ ,  $AINN = \text{AGND}$ ,  $f_{\text{CLKIN}} = 20\text{ MHz}$ , and sinc<sup>3</sup> filter with OSR = 256 (unless otherwise noted)

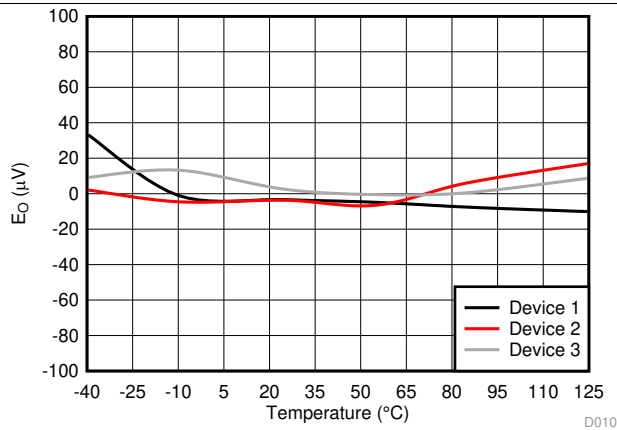


Figure 11. Offset Error vs Temperature

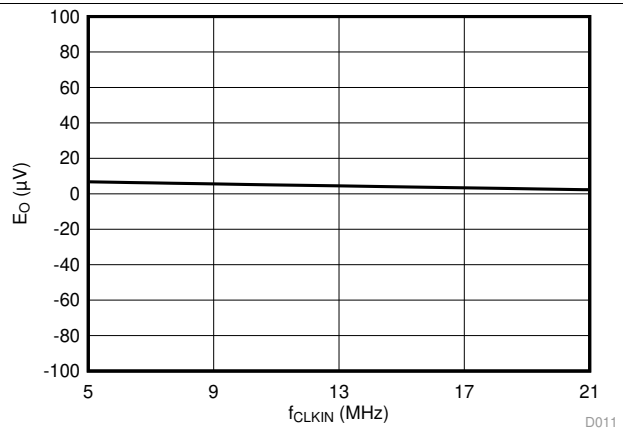


Figure 12. Offset Error vs Clock Frequency

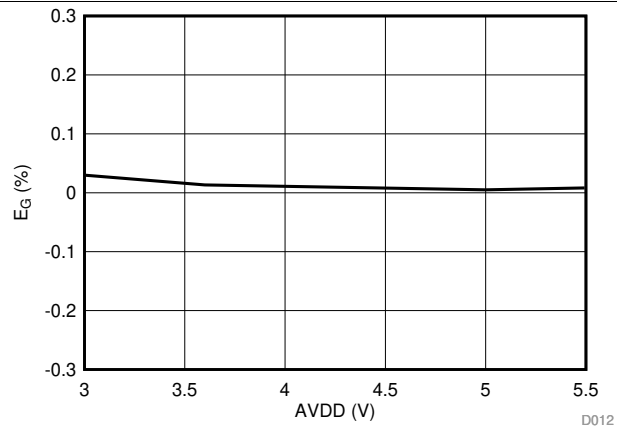


Figure 13. Gain Error vs High-Side Supply Voltage

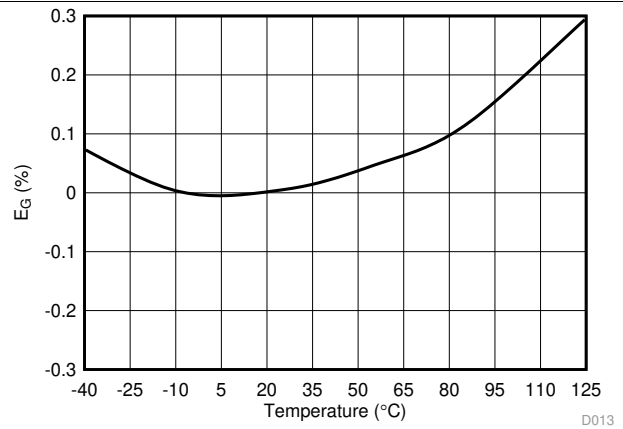


Figure 14. Gain Error vs Temperature

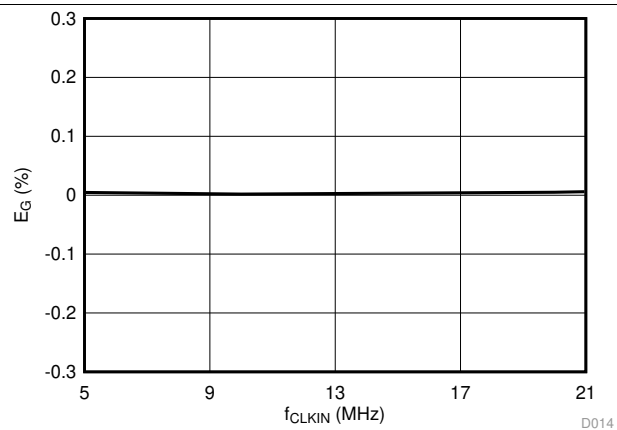


Figure 15. Gain Error vs Clock Frequency

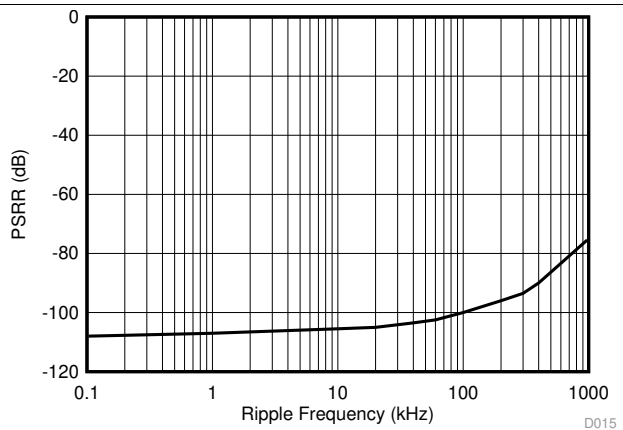


Figure 16. Power-Supply Rejection Ratio vs Ripple Frequency

Typical Characteristics (continued)

at  $T_A = 25^\circ\text{C}$ ,  $AVDD = 5\text{ V}$ ,  $DVDD = 3.3\text{ V}$ ,  $AINP = -50\text{ mV to }50\text{ mV}$ ,  $AINN = AGND$ ,  $f_{CLKIN} = 20\text{ MHz}$ , and sinc<sup>3</sup> filter with OSR = 256 (unless otherwise noted)

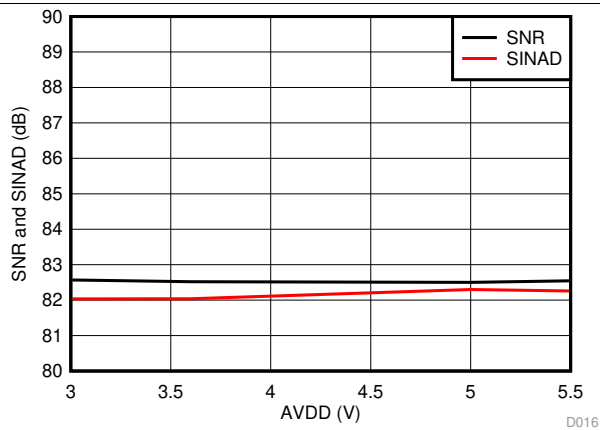


Figure 17. Signal-to-Noise Ratio and Signal-to-Noise + Distortion vs High-Side Supply Voltage

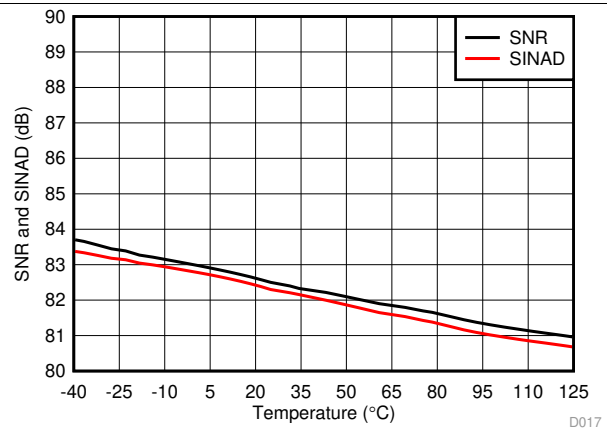


Figure 18. Signal-to-Noise Ratio and Signal-to-Noise + Distortion vs Temperature

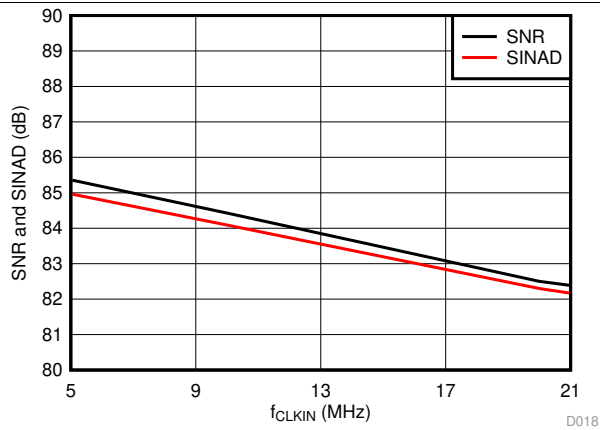


Figure 19. Signal-to-Noise Ratio and Signal-to-Noise + Distortion vs Clock Frequency

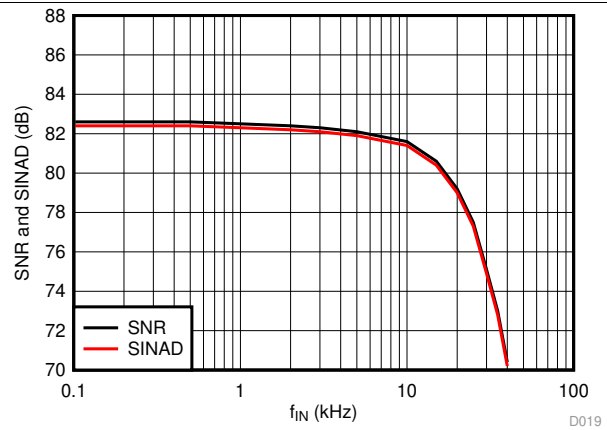


Figure 20. Signal-to-Noise Ratio and Signal-to-Noise + Distortion vs Input Signal Frequency

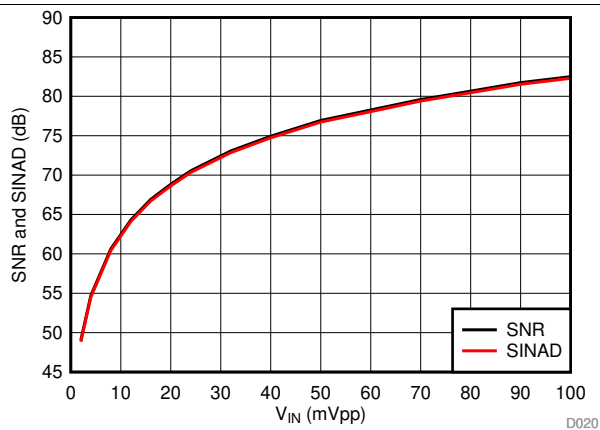


Figure 21. Signal-to-Noise Ratio and Signal-to-Noise + Distortion vs Input Signal Amplitude

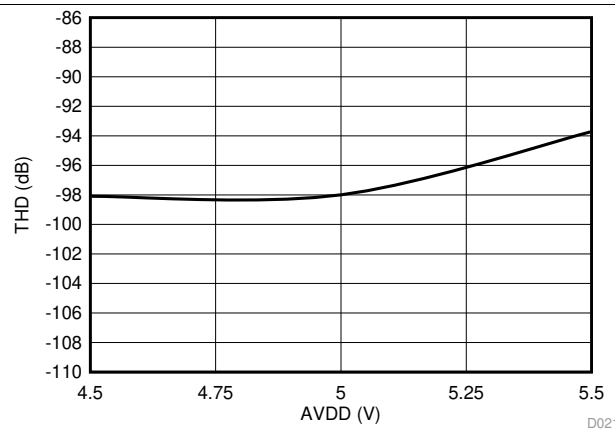
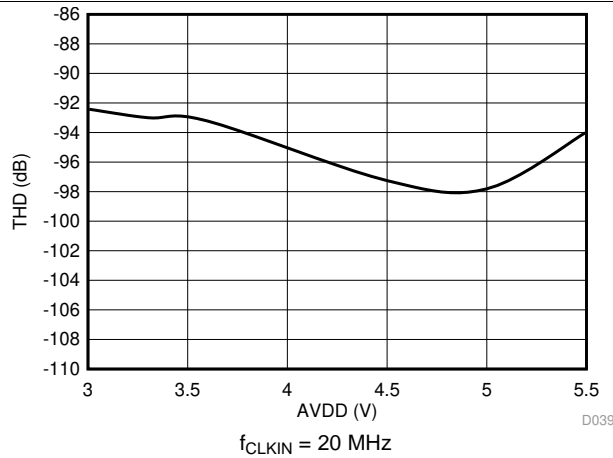


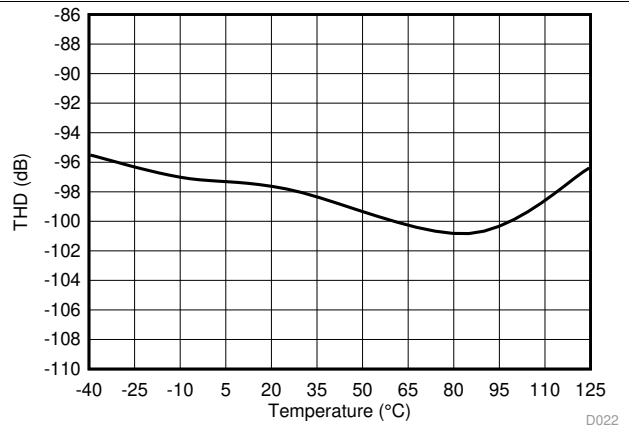
Figure 22. Total Harmonic Distortion vs High-Side Supply Voltage

**Typical Characteristics (continued)**

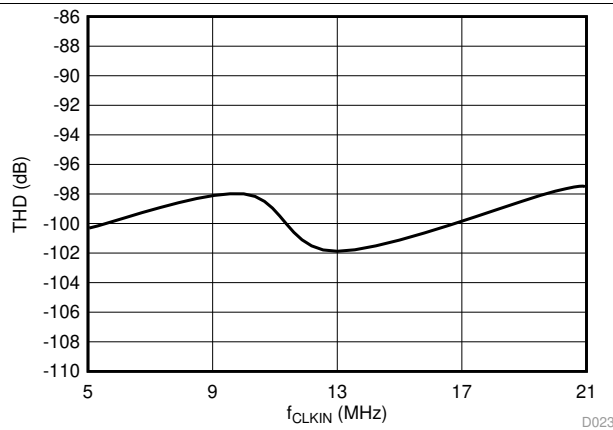
at  $T_A = 25^\circ\text{C}$ ,  $AVDD = 5\text{ V}$ ,  $DVDD = 3.3\text{ V}$ ,  $AINP = -50\text{ mV to }50\text{ mV}$ ,  $AINN = \text{AGND}$ ,  $f_{\text{CLKIN}} = 20\text{ MHz}$ , and sinc<sup>3</sup> filter with OSR = 256 (unless otherwise noted)



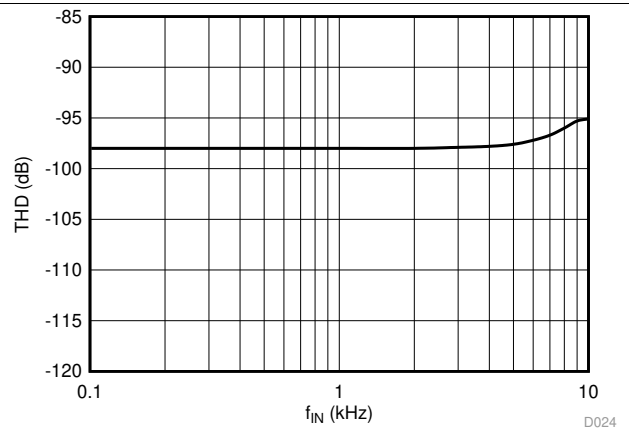
**Figure 23. Total Harmonic Distortion vs High-Side Supply Voltage**



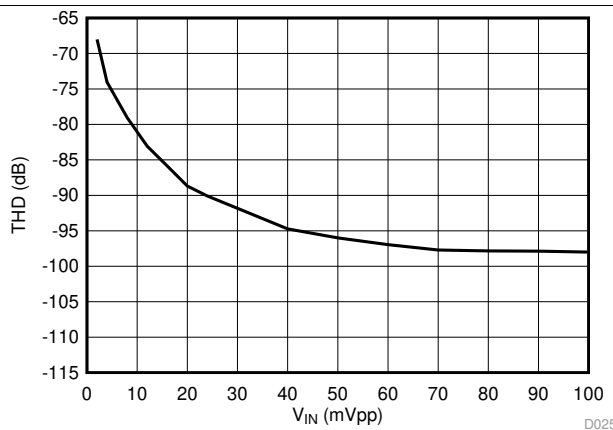
**Figure 24. Total Harmonic Distortion vs Temperature**



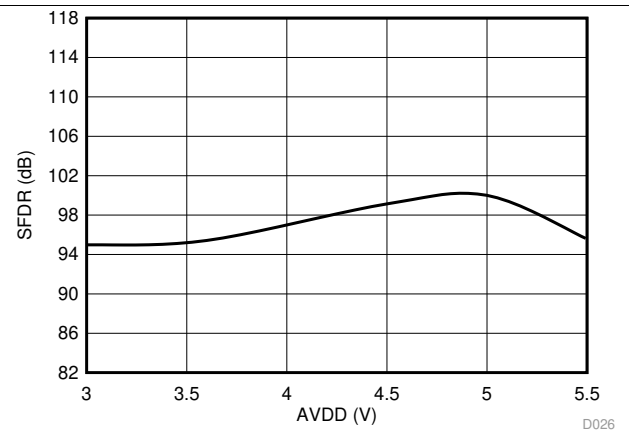
**Figure 25. Total Harmonic Distortion vs Clock Frequency**



**Figure 26. Total Harmonic Distortion vs Input Signal Frequency**



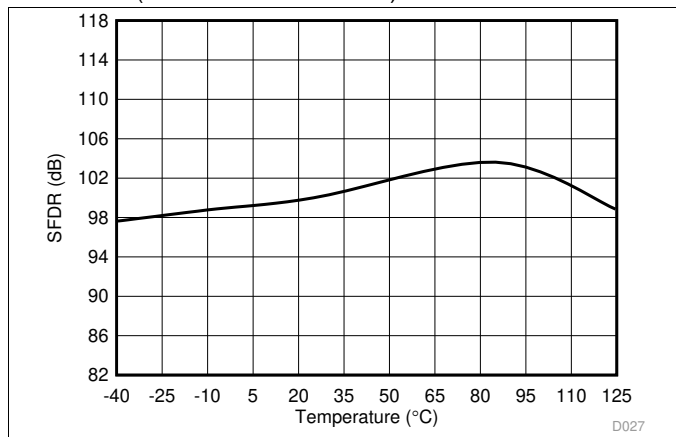
**Figure 27. Total Harmonic Distortion vs Input Signal Amplitude**



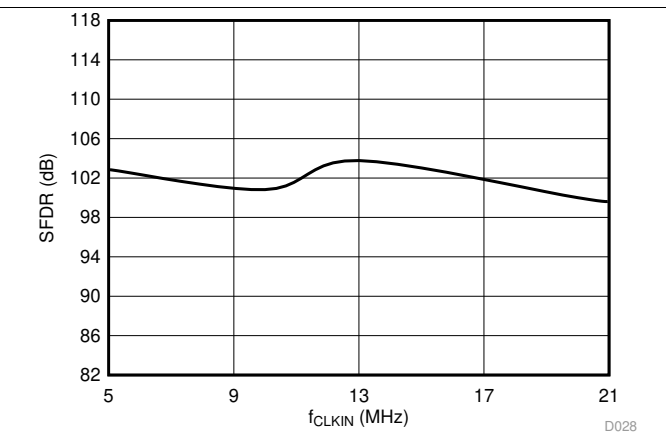
**Figure 28. Spurious-Free Dynamic Range vs High-Side Supply Voltage**

**Typical Characteristics (continued)**

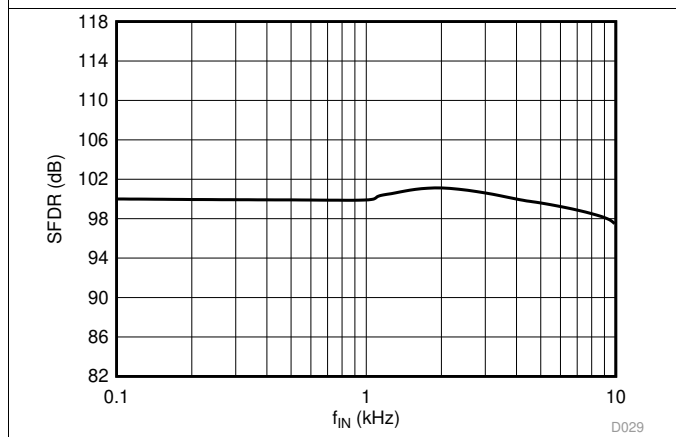
at  $T_A = 25^\circ\text{C}$ ,  $AVDD = 5\text{ V}$ ,  $DVDD = 3.3\text{ V}$ ,  $AINP = -50\text{ mV to }50\text{ mV}$ ,  $AINN = AGND$ ,  $f_{CLKIN} = 20\text{ MHz}$ , and sinc<sup>3</sup> filter with OSR = 256 (unless otherwise noted)



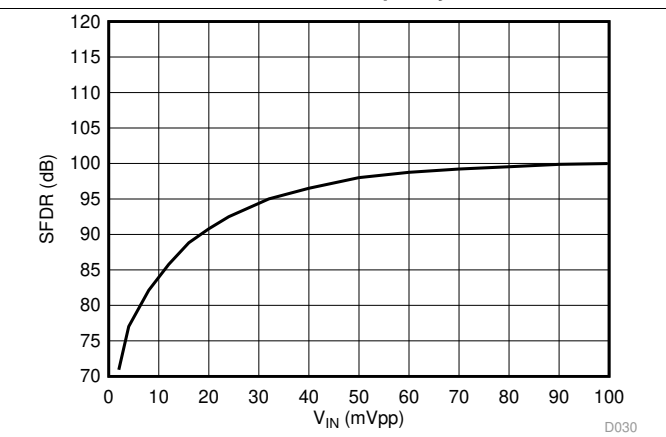
**Figure 29. Spurious-Free Dynamic Range vs Temperature**



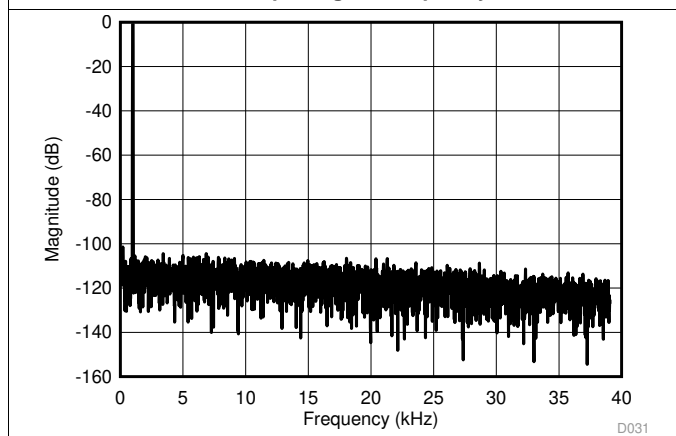
**Figure 30. Spurious-Free Dynamic Range vs Clock Frequency**



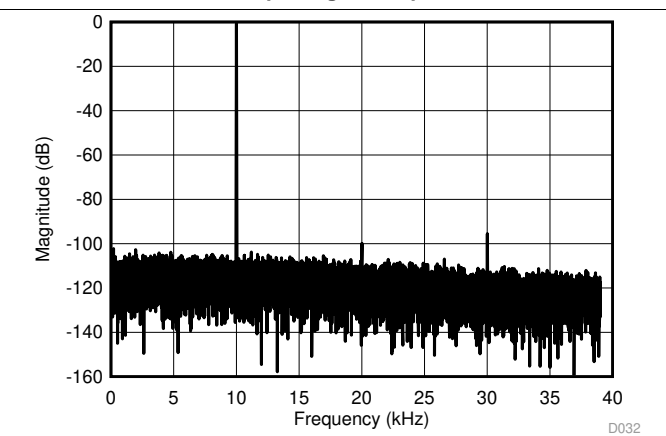
**Figure 31. Spurious-Free Dynamic Range vs Input Signal Frequency**



**Figure 32. Spurious-Free Dynamic Range vs Input Signal Amplitude**



**Figure 33. Frequency Spectrum With 1-kHz Input Signal**



**Figure 34. Frequency Spectrum With 10-kHz Input Signal**

Typical Characteristics (continued)

at  $T_A = 25^\circ\text{C}$ ,  $AVDD = 5\text{ V}$ ,  $DVDD = 3.3\text{ V}$ ,  $AINP = -50\text{ mV to }50\text{ mV}$ ,  $AINN = AGND$ ,  $f_{CLKIN} = 20\text{ MHz}$ , and sinc<sup>3</sup> filter with  $OSR = 256$  (unless otherwise noted)

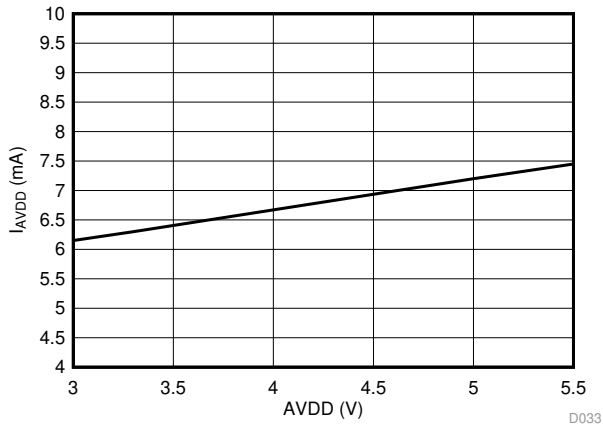


Figure 35. High-Side Supply Current vs High-Side Supply Voltage

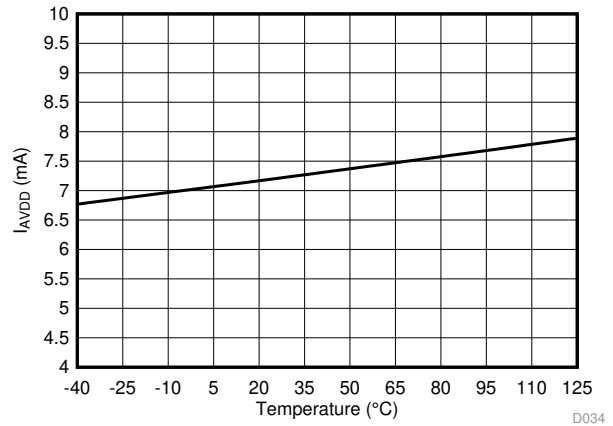


Figure 36. High-Side Supply Current vs Temperature

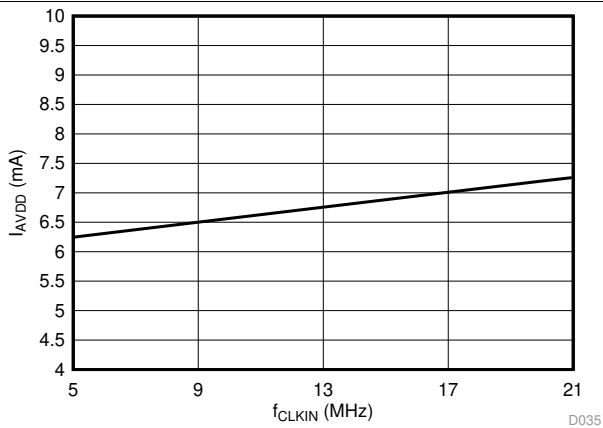


Figure 37. High-Side Supply Current vs Clock Frequency

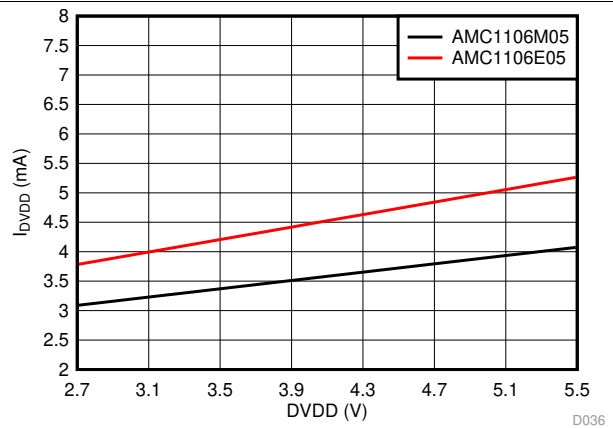


Figure 38. Controller-Side Supply Current vs Controller-Side Supply Voltage

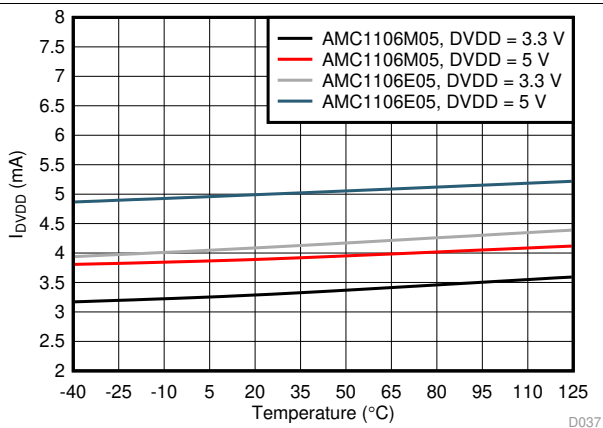


Figure 39. Controller-Side Supply Current vs Temperature

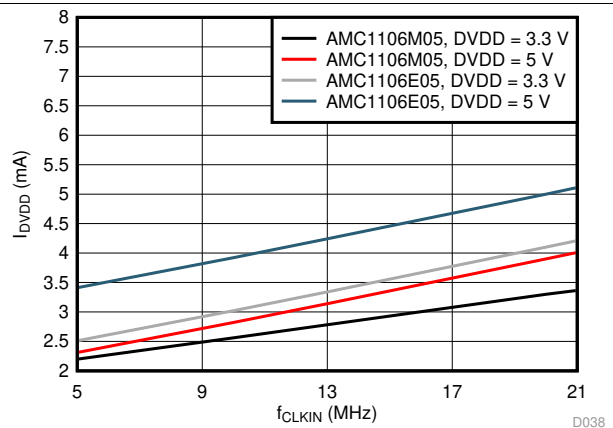


Figure 40. Controller-Side Supply Current vs Clock Frequency



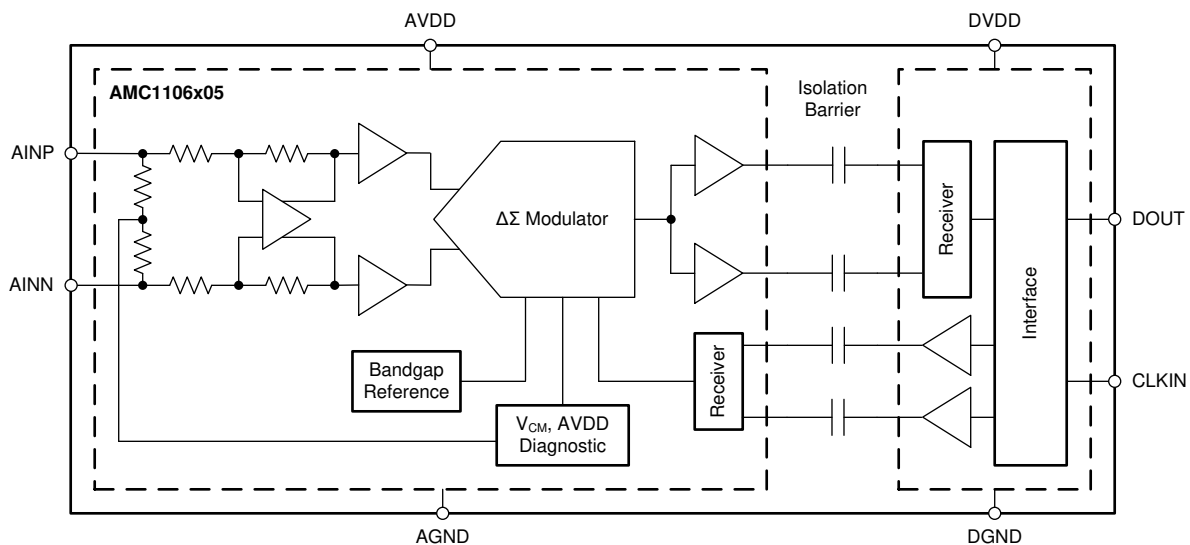
## 8 Detailed Description

### 8.1 Overview

The analog input stage of the AMC1106 is a fully differential amplifier that feeds the second-order, delta-sigma ( $\Delta\Sigma$ ) modulator that digitizes the input signal into a 1-bit output stream. The isolated data output DOUT of the converter provides a stream of digital ones and zeros that is synchronous to the externally-provided clock source at the CLKIN pin with a frequency as specified in the [Switching Characteristics](#) table. The time average of this serial bitstream output is proportional to the analog input voltage.

The [Functional Block Diagram](#) section shows a detailed block diagram of the AMC1106. The analog input range is tailored to directly accommodate a voltage drop across a shunt resistor used for current sensing. The silicon-dioxide ( $\text{SiO}_2$ ) based capacitive isolation barrier supports a high level of magnetic field immunity as described in the [ISO72x Digital Isolator Magnetic-Field Immunity](#) application report, available for download at [www.ti.com](#). The external clock input simplifies the synchronization of multiple current-sensing channels on the system level. The extended frequency range of up to 21 MHz supports higher performance levels compared to the other solutions available on the market.

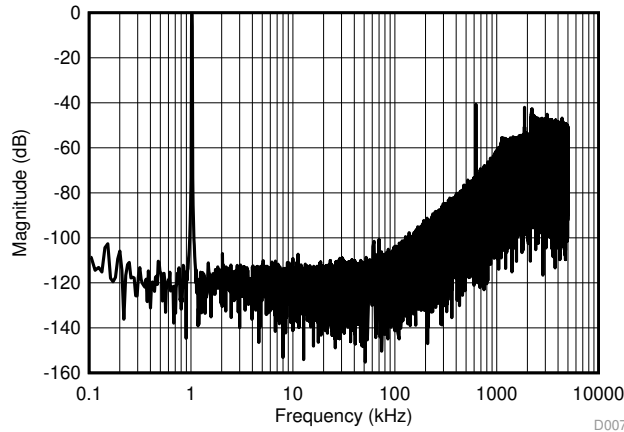
### 8.2 Functional Block Diagram



### 8.3 Feature Description

#### 8.3.1 Analog Input

The AMC1106 incorporates front-end circuitry that contains a differential amplifier and sampling stage, followed by a  $\Delta\Sigma$  modulator. The gain of the differential amplifier is set by internal precision resistors to a factor of 20 with a differential input resistance of 4.9 k $\Omega$ . For reduced offset and offset drift, the differential amplifier is chopper-stabilized with the switching frequency set at  $f_{CLKIN} / 32$ . Figure 41 shows that the switching frequency generates a spur. The impact of this spur on the overall system-level performance depends on the digital filter settings.



$\text{sinc}^3$  filter,  $\text{OSR} = 2$ ,  $f_{CLKIN} = 20 \text{ MHz}$ ,  $f_{IN} = 1 \text{ kHz}$

**Figure 41. Quantization Noise Shaping**

There are two restrictions on the analog input signals (AINP and AINN). First, if the input voltage exceeds the range  $\text{AGND} - 6 \text{ V}$  to  $\text{AVDD} + 0.5 \text{ V}$ , the input current must be limited to 10 mA because the device input electrostatic discharge (ESD) diodes turn on. In addition, the linearity and noise performance of the device are ensured only when the differential analog input voltage remains within the specified linear full-scale range (FSR) and within the specified input common-mode voltage range ( $V_{CM}$ ).

## Feature Description (continued)

### 8.3.2 Modulator

The modulator implemented in the AMC1106 (such as the one conceptualized in Figure 42) is a second-order, switched-capacitor, feed-forward  $\Delta\Sigma$  modulator. The analog input voltage  $V_{IN}$  and the output  $V_5$  of the 1-bit digital-to-analog converter (DAC) are subtracted, providing an analog voltage  $V_1$  at the input of the first integrator stage. The output of the first integrator feeds the input of the second integrator stage, resulting in output voltage  $V_3$  that is subtracted from the input signal  $V_{IN}$  and the output of the first integrator  $V_2$ . Depending on the polarity of the resulting voltage  $V_4$ , the output of the comparator is changed. In this case, the 1-bit DAC responds on the next clock pulse by changing its analog output voltage  $V_5$ , causing the integrators to progress in the opposite direction and forcing the value of the integrator output to track the average value of the input.

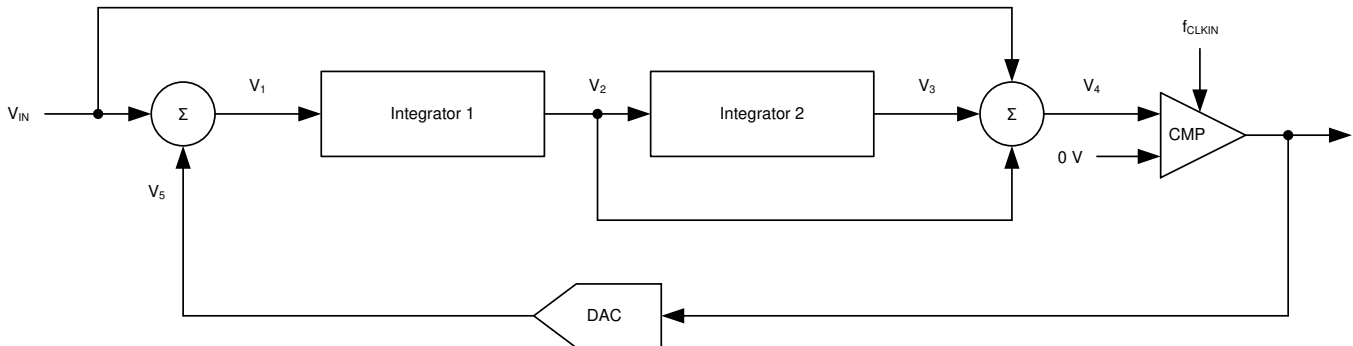


Figure 42. Block Diagram of a Second-Order Modulator

The modulator shifts the quantization noise to high frequencies; see Figure 41. Therefore, use a low-pass digital filter at the output of the device to increase the overall performance. This filter is also used to convert from the 1-bit data stream at a high sampling rate into a higher-bit data word at a lower rate (decimation). TI's microcontroller family MSP430F67x offers a path to directly access the integrated sinc-filters of the SD24\_B ADCs for a simple system-level solution for multichannel, isolated current sensing. Also, the microcontroller families TMS320F2807x and TMS320F2837x offer a suitable programmable, hardwired filter structure termed a *sigma-delta filter module* (SDFM) optimized for usage with the AMC1106. An additional option is to use a suitable application-specific device, such as the AMC1210 (a four-channel digital sinc-filter). Alternatively, a field-programmable gate array (FPGA) can be used to implement the filter.

## Feature Description (continued)

### 8.3.3 Isolation Channel Signal Transmission

The AMC1106 uses an on-off keying (OOK) modulation scheme to transmit the modulator output bitstream across the capacitive SiO<sub>2</sub>-based isolation barrier. The transmitter modulates the bitstream at TX IN in [Figure 43](#) with an internally-generated, 480-MHz carrier across the isolation barrier to represent a digital *one* and sends a *no signal* to represent the digital *zero*. The receiver demodulates the signal after advanced signal conditioning and produces the output. The symmetrical design of each isolation channel improves the CMTI performance and reduces the radiated emissions caused by the high-frequency carrier. [Figure 43](#) shows a block diagram of an isolation channel integrated in the AMC1106.

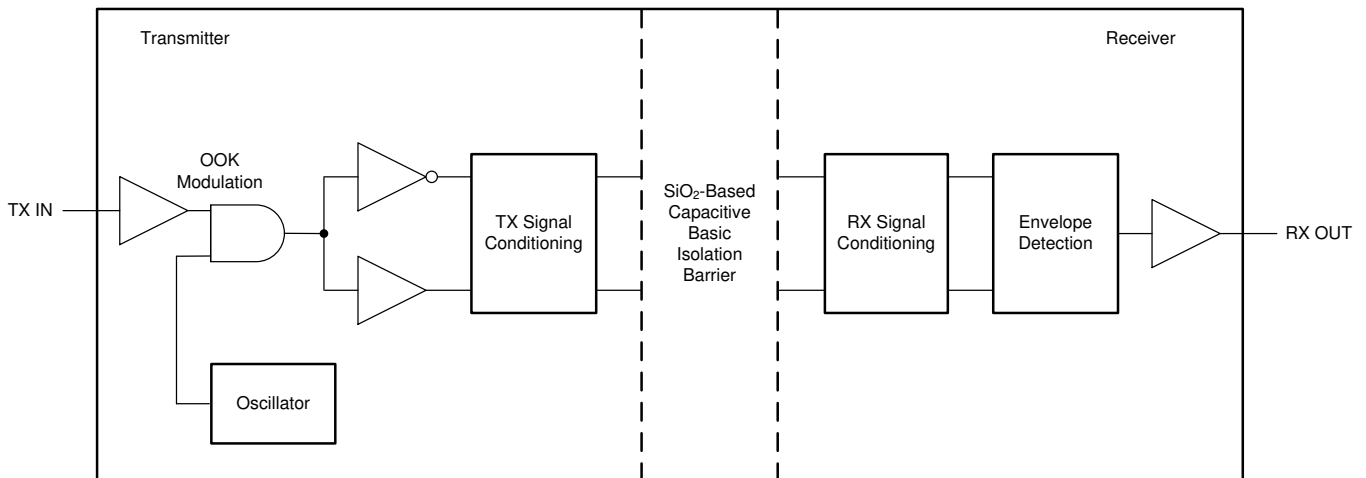


Figure 43. Block Diagram of an Isolation Channel

[Figure 44](#) shows the concept of the on-off keying scheme.

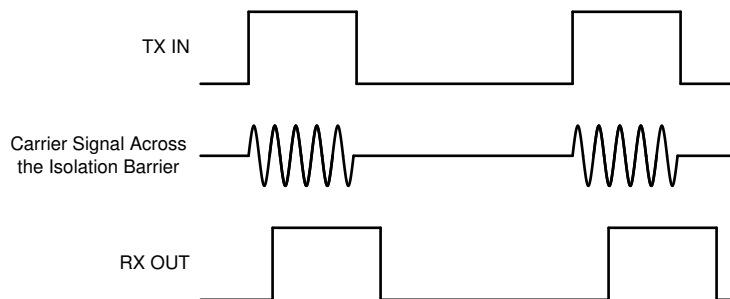
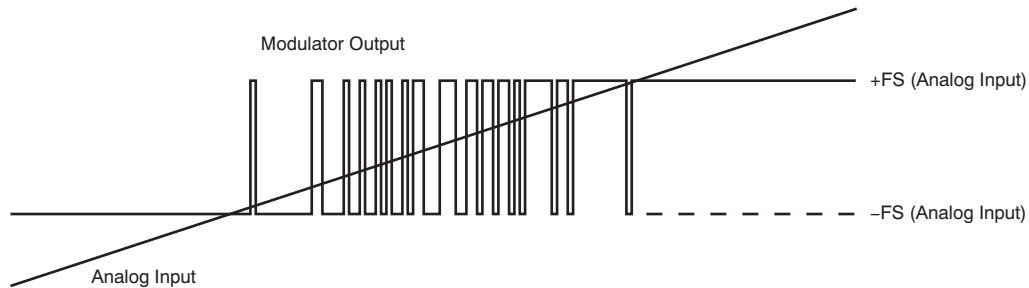


Figure 44. OOK-Based Modulation Scheme

## Feature Description (continued)

### 8.3.4 Digital Output

A differential input signal of 0 V ideally produces a stream of ones and zeros that are high 50% of the time. A differential input of 50 mV produces a stream of ones and zeros that are high 89.06% of the time. With 16 bits of resolution on the decimation filter, that percentage ideally corresponds to code 58368. A differential input of –50 mV produces a stream of ones and zeros that are high 10.94% of the time and ideally results in code 7168 with a 16-bit resolution decimation filter. This –50-mV to 50-mV input voltage range is also the specified linear range FSR of the AMC1106 with performance as specified in this document. If the input voltage value exceeds this range, the output of the modulator shows nonlinear behavior where the quantization noise increases. The output of the modulator clips with a stream of only zeros with an input less than or equal to –64 mV or with a stream of only ones with an input greater than or equal to 64 mV. In this case, however, the AMC1106 generates a single 1 (if the input is at negative full-scale) or 0 every 128 clock cycles to indicate proper device function (see the [Fail-Safe Output](#) section for more details). [Figure 45](#) shows the input voltage versus the modulator output signal.



**Figure 45. Analog Input versus AMC1106 Modulator Output**

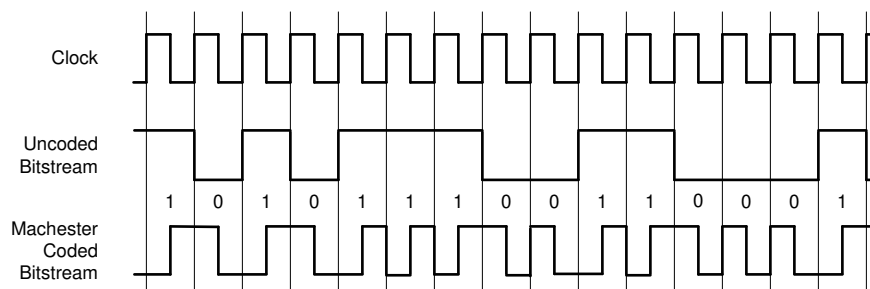
[Equation 1](#) calculates the density of ones in the output bitstream for any input voltage value (with the exception of a full-scale input signal, as described in the [Output Behavior in Case of a Full-Scale Input](#) section):

$$\frac{V_{IN} + V_{Clipping}}{2 \times V_{Clipping}} \quad (1)$$

The AMC1106 system clock is provided externally at the CLKIN pin. For more details, see the [Switching Characteristics](#) table and the [Manchester Coding Feature](#) section.

### 8.3.5 Manchester Coding Feature

The AMC1106E05 offers the IEEE 802.3-compliant Manchester coding feature that generates at least one transition per bit to support clock signal recovery from the bitstream. A Manchester coded bitstream is free of dc components and supports single-wire data and clock transfer without having to consider the setup and hold time requirements of the receiving device. The Manchester coding combines the clock and data information using exclusive or (XOR) logical operation. [Figure 46](#) shows the resulting bitstream. The duty cycle of the Manchester encoded bitstream depends on the duty cycle of the input clock CLKIN.



**Figure 46. Manchester Coded Output of the AMC1106E05**

## 8.4 Device Functional Modes

### 8.4.1 Fail-Safe Output

In the case of a missing AVDD high-side supply voltage, the output of the  $\Delta\Sigma$  modulator is not defined and can cause a system malfunction. In systems with high safety requirements, this behavior is not acceptable. Therefore, as shown in Figure 47, the AMC1106 implements a fail-safe output function that ensures that the DOUT output of the device offers a steady-state bitstream of logic 0's in case of a missing AVDD.

Similarly, as also shown in Figure 47, if the common-mode voltage of the input reaches or exceeds the specified common-mode overvoltage detection level  $V_{CMov}$  as defined in the *Electrical Characteristics* table, the AMC1106 generates a steady-state bitstream of logic 1's at the DOUT output.

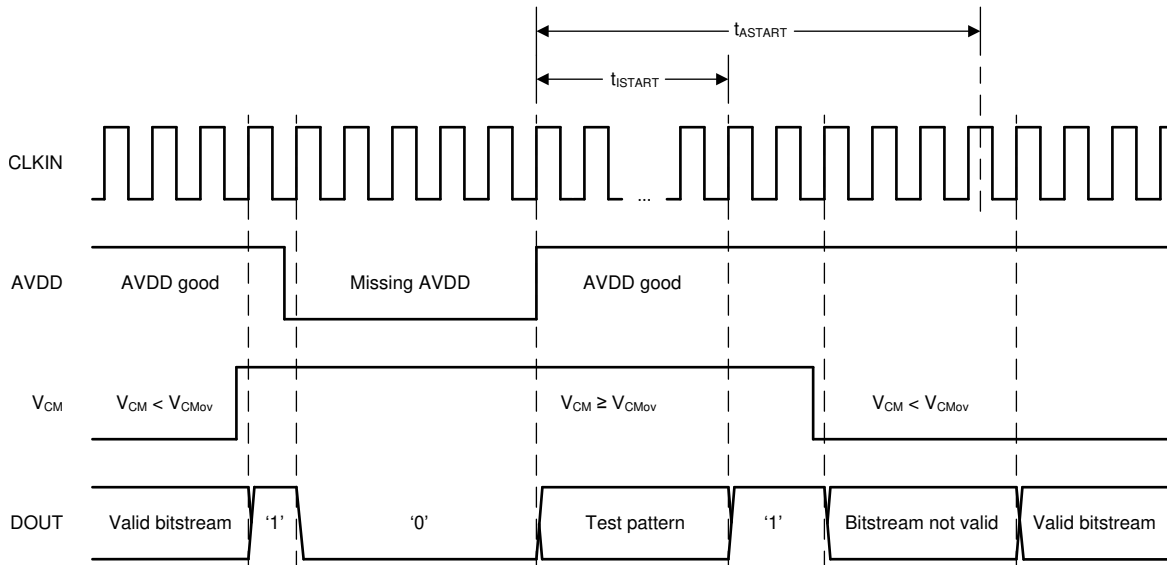


Figure 47. Fail-Safe Output of the AMC1106

### 8.4.2 Output Behavior in Case of a Full-Scale Input

If a full-scale input signal is applied to the AMC1106 (that is,  $|V_{IN}| \geq |V_{Clipping}|$ ), Figure 48 shows that the device generates a single one or zero every 128 bits at DOUT, depending on the actual polarity of the signal being sensed. In this way, differentiating between a missing AVDD and a full-scale input signal is possible on the system level.

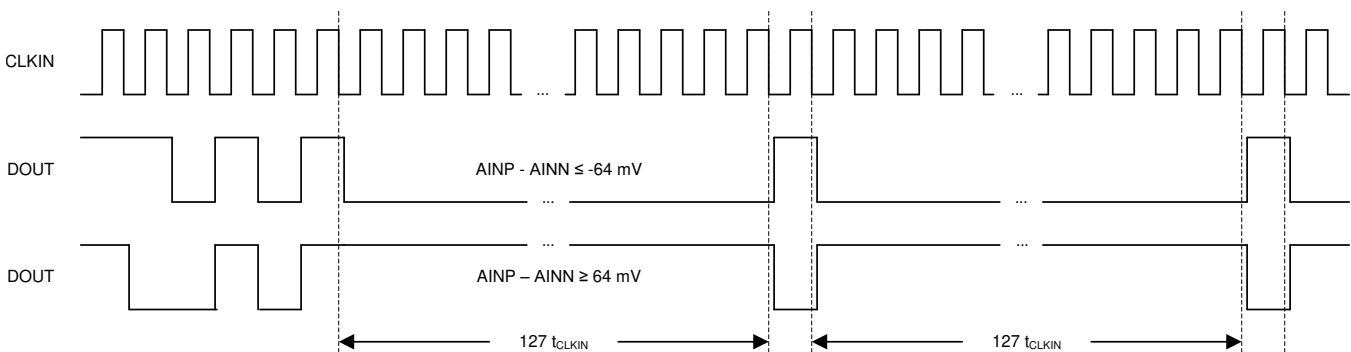


Figure 48. Overrange Output of the AMC1106

## 9 Application and Implementation

### NOTE

Information in the following applications sections is not part of the TI component specification, and TI does not warrant its accuracy or completeness. TI's customers are responsible for determining suitability of components for their purposes. Customers should validate and test their design implementation to confirm system functionality.

---

### 9.1 Application Information

#### 9.1.1 Digital Filter Usage

The modulator generates a bit stream that is processed by a digital filter to obtain a digital word similar to a conversion result of a conventional analog-to-digital converter (ADC). A very simple filter, shown in [Equation 2](#), built with minimal effort and hardware, is a sinc<sup>3</sup>-type filter:

$$H(z) = \left( \frac{1 - z^{-OSR}}{1 - z^{-1}} \right)^3 \quad (2)$$

This filter provides the best output performance at the lowest hardware size (count of digital gates) for a second-order modulator. All the characterization in this document is also done with a sinc<sup>3</sup> filter with an oversampling ratio (OSR) of 256 and an output word width of 16 bits.

An example code for implementing a sinc<sup>3</sup> filter in an FPGA is discussed in application note [Combining ADS1202 with FPGA Digital Filter for Current Measurement in Motor Control Applications](#), available for download at [www.ti.com](http://www.ti.com).

## 9.2 Typical Application

$\Delta\Sigma$  ADCs are widely used for current measurement in electricity meters because of the high ac accuracy obtained over a wide dynamic range that is achieved by averaging in the digital filter. As a result of their inherent isolation, current transformers (CT) were commonly used as current sensors in 3-phase electricity meters in the past. A strong magnetic field can saturate a CT and stop proper energy measurement. Shunt resistors are immune to magnetic fields and can be used to design temper-free electricity meters. The input structure of the AMC1106 is optimized for use with low-impedance shunt resistors to minimize the power dissipation of the circuit. The transformerless galvanic isolation of the bitstream as implemented in the AMC1106 is tailored for shunt-based current sensing in modern 3-phase electricity meter designs.

Figure 49 shows a simplified schematic of the AMC1106 in a shunt-based, 3-phase electricity meter application.

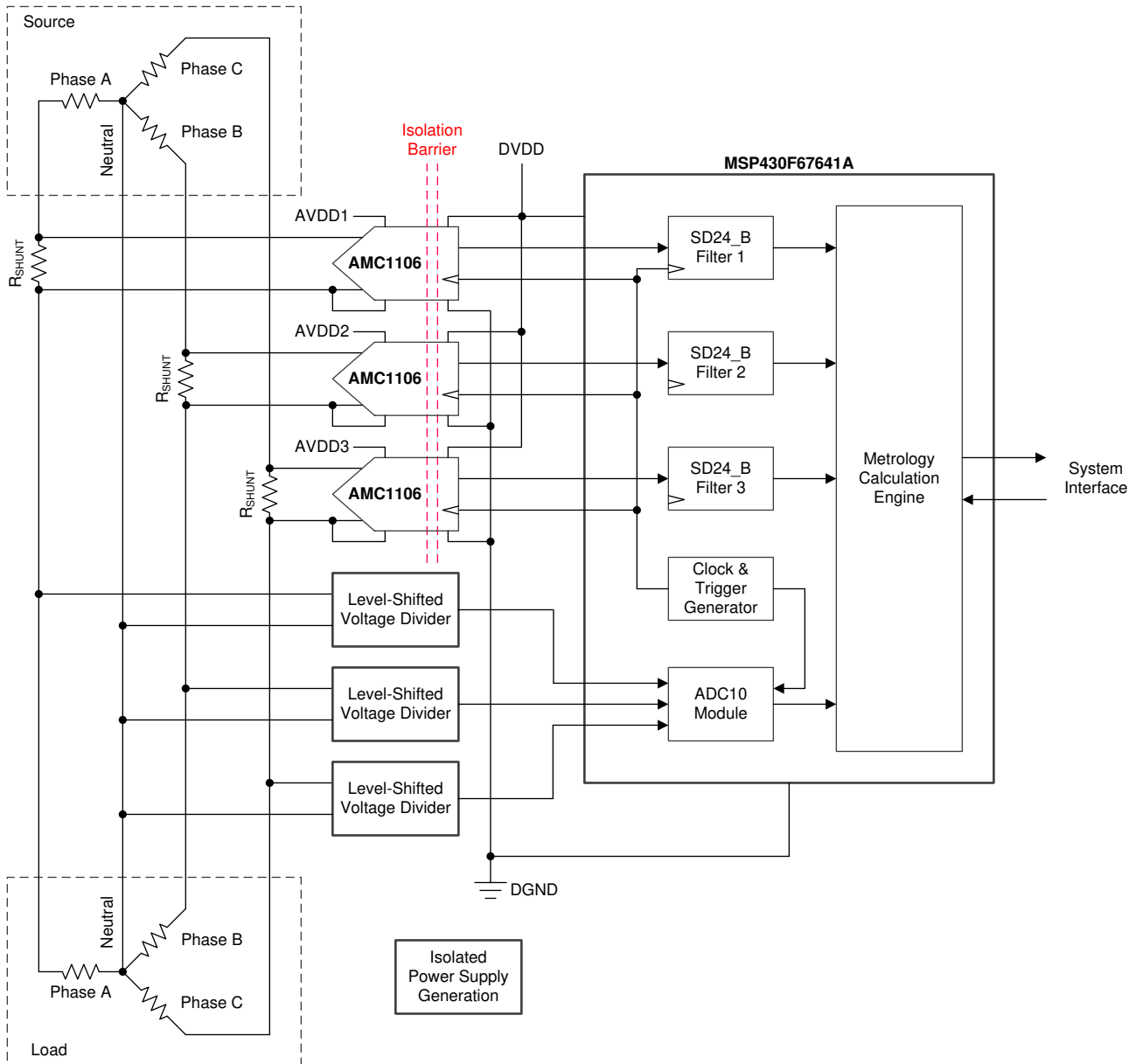


Figure 49. The AMC1106 in a 3-Phase Electricity Meter Application



## Typical Application (continued)

### 9.2.1 Design Requirements

Table 1 lists the parameters for the this typical application.

**Table 1. Design Requirements**

PARAMETER	VALUE
AVDD1, AVDD2, and AVDD3 high-side supply voltages	3.3 V or 5 V
DVDD low-side supply voltage	3.3 V or 5 V
Voltage drop across the shunt for a linear response	±50 mV (maximum)
Accuracy	Class 0.5 or better

### 9.2.2 Detailed Design Procedure

The high-side power supply (AVDD) for the AMC1106 is externally derived from either a capacitive-drop or a coreless transformer power-supply circuit. Further details are provided in the [Power Supply Recommendations](#) section.

The floating ground reference (AGND) is derived from one of the ends of the shunt resistor that is connected to the analog inputs of the AMC1106. If a four-pin shunt is used, the inputs of the device are connected to the inner leads and AGND is connected to one of the outer shunt leads.

Use Ohm's Law to calculate the voltage drop across the shunt resistor ( $V_{SHUNT}$ ) for the desired measured current:  $V_{SHUNT} = I \times R_{SHUNT}$ .

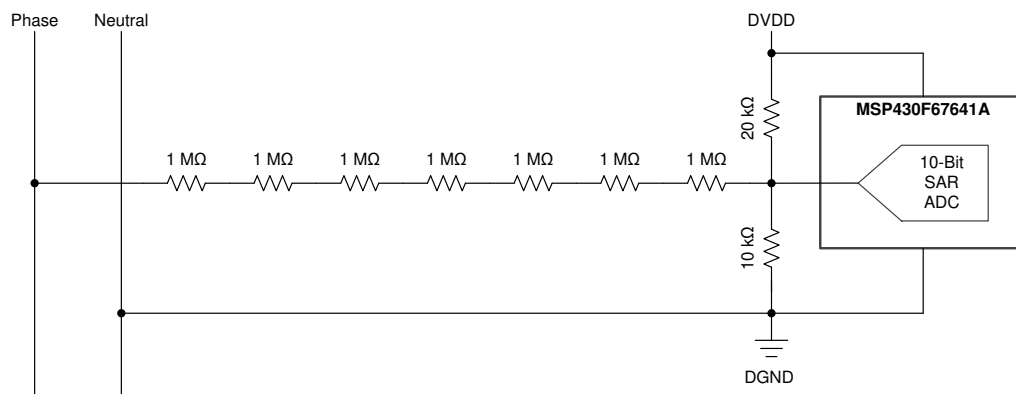
Consider the following two restrictions to choose the proper value of the shunt resistor  $R_{SHUNT}$ :

- The voltage drop caused by the nominal current range must not exceed the recommended differential input voltage range:  $V_{SHUNT} \leq \pm 50 \text{ mV}$
- The voltage drop caused by the maximum allowed overcurrent must not exceed the input voltage that causes a clipping output:  $|V_{SHUNT}| \leq |V_{Clipping}|$

Use an RC filter in front of the AMC1106 to improve the overall signal-to-noise performance of the system and improve the immunity of the circuit to high-frequency electromagnetic fields.

For the AMC1106 output bitstream averaging, a poly-phase device version from TI's [MSP430F67x](#) family of low-power microcontrollers (MCUs) is recommended. This family offers the sigma-delta module (SD24\_B) that allows for bypassing the internal modulator and directly accessing the digital filter. The integrated trigger and clock generator support synchronization of all three AMC1106 devices and the internal 10-bit SAR ADC that is used to deliver the voltage information of all phases.

Figure 50 shows a voltage divider circuit with a common-mode set to 1/3 of the supply voltage that is used to adjust the mains voltage signal to the input voltage range of the SAR ADC used in the MSP430F67641A.

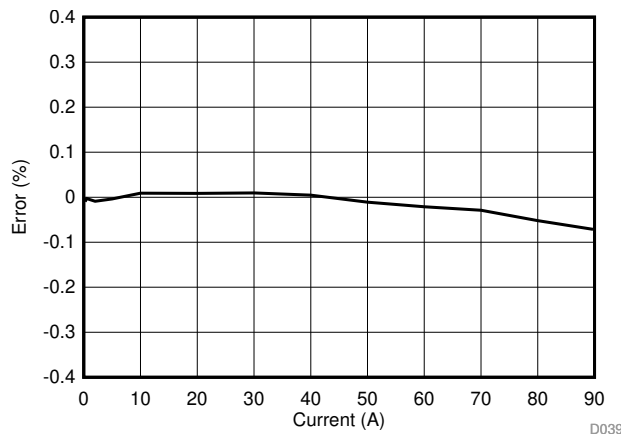


**Figure 50. Level-Shifted Voltage Divider**

For further design recommendations and system level considerations, see the [Multi-Phase Power Quality Measurement With Isolated Shunt Sensors](#) or the [Magnetically Immune Transformerless Power Supply for Isolated Shunt Current Measurement](#) reference designs offered by TI.

### 9.2.3 Application Curve

In electricity metering applications, the initial calibration of the offset, gain, and phase errors is absolutely necessary to correctly sense the current and voltage signals, and calculate the power with the required system level accuracy as per regional regulations. After system calibration, an electricity meter circuit based on the shunt resistors, the AMC1106, and the MSP430F67x support error levels below  $\pm 0.2\%$ , as shown in [Figure 51](#) and the documentation of the reference designs listed previously.



**Figure 51. Active Energy Error**

### 9.2.4 What To Do and What Not To Do

Do not leave the inputs of the AMC1106 unconnected (floating) when the device is powered up. If both modulator inputs are left floating, the input bias current drives these inputs to the output common-mode voltage level of the differential amplifier of approximately 1.9 V. If that voltage is above the specified input common-mode range, the gain of the differential amplifier diminishes and the modulator outputs a bitstream resembling a zero differential input voltage.

## 10 Power Supply Recommendations

For lowest system-level cost, the high-side power supply (AVDD) for the AMC1106 is derived from an external capacitive-drop power supply. The *Magnetically Immune Transformerless Power Supply for Isolated Shunt Current Measurement* reference design and Figure 52 shows a proven solution based on a 6.2-V diode and the TLV70450 5-V low dropout (LDO) regulator. A low equivalent series resistance (ESR) decoupling capacitor of 0.1  $\mu\text{F}$  is recommended for filtering this power-supply path. Place this capacitor (C5 in Figure 52) as close as possible to the AVDD pin of the AMC1106 for best performance.

The floating ground reference (AGND) is derived from the end of the shunt resistor that is also connected to the negative input (AINN) of the device. If a four-pin shunt is used, the device inputs are connected to the inner leads and AGND is connected to one of the outer leads of the shunt.

For decoupling of the digital power supply on the controller side, TI recommends using a 0.1- $\mu\text{F}$  capacitor (C6 in Figure 52) assembled as close to the DVDD pin of the AMC1106 as possible, followed by an additional capacitor in the range of 1  $\mu\text{F}$  to 10  $\mu\text{F}$ .

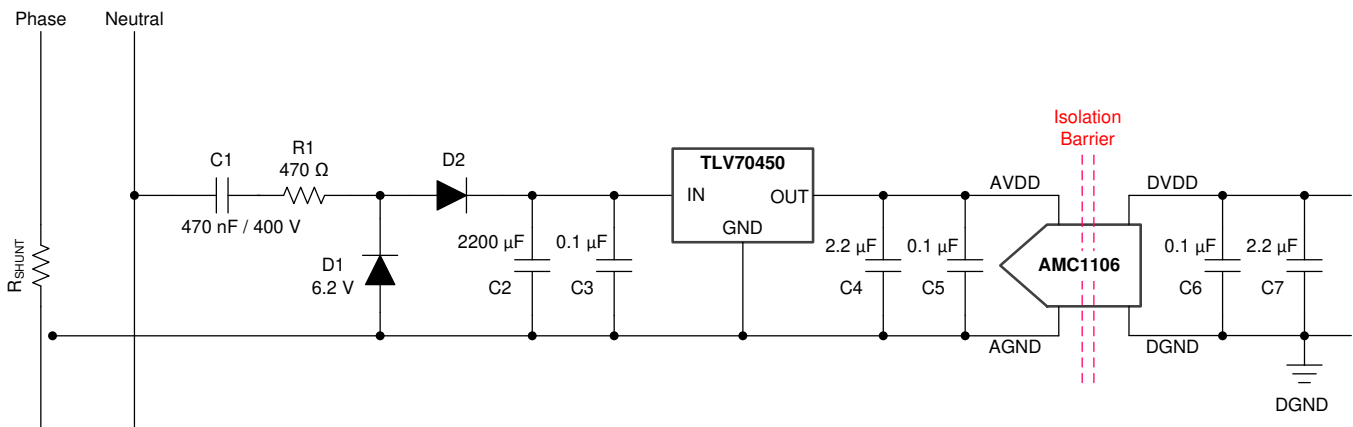


Figure 52. Capacitive-Drop Solution for the AMC1106 AVDD Supply

## 11 Layout

### 11.1 Layout Guidelines

Figure 53 shows a layout recommendation example based on an on-board, 4-wire shunt resistor that details the critical placement of the decoupling capacitors (as close as possible to the AMC1106 supply pins) and the placement of the other components required by the device. For best performance, place the shunt resistor close to the AINP and AINN inputs of the AMC1106 and keep the layout of both connections symmetrical.

### 11.2 Layout Example

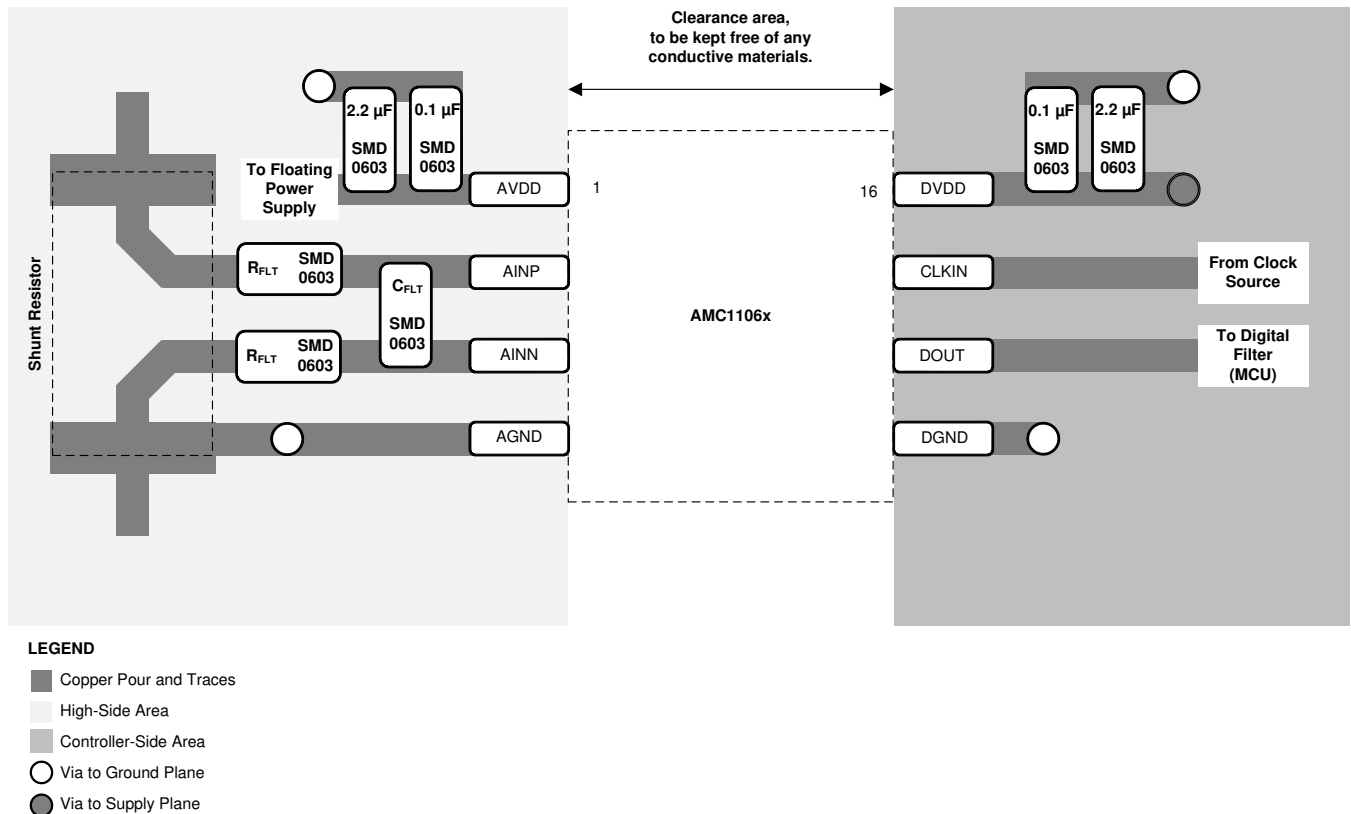


Figure 53. Recommended Layout of the AMC1106

## 12 Device and Documentation Support

### 12.1 Device Support

#### 12.1.1 Device Nomenclature

##### 12.1.1.1 Isolation Glossary

See the [Isolation Glossary](#)

### 12.2 Documentation Support

#### 12.2.1 Related Documentation

For related documentation see the following:

- Texas Instruments, [AMC1210 Quad Digital Filter for 2nd-Order Delta-Sigma Modulator data sheet](#)
- Texas Instruments, [MSP430F67x Polyphase Metering SoCs data sheet](#)
- Texas Instruments, [TMS320F2807x Piccolo™ Microcontrollers data sheet](#)
- Texas Instruments, [TMS320F2837xD Dual-Core Delfino™ Microcontrollers data sheet](#)
- Texas Instruments, [TLV704 24-V Input Voltage, 150-mA, Ultralow I<sub>Q</sub> Low-Dropout Regulators data sheet](#)
- Texas Instruments, [ISO72x Digital Isolator Magnetic-Field Immunity application report](#)
- Texas Instruments, [Combining ADS1202 with FPGA Digital Filter for Current Measurement in Motor Control Applications application report](#)
- Texas Instruments, [Multi-Phase Power Quality Measurement With Isolated Shunt Sensors](#)
- Texas Instruments, [Magnetically Immune Transformerless Power Supply for Isolated Shunt Current Measurement](#)

### 12.3 Related Links

The table below lists quick access links. Categories include technical documents, support and community resources, tools and software, and quick access to order now.

**Table 2. Related Links**

PARTS	PRODUCT FOLDER	ORDER NOW	TECHNICAL DOCUMENTS	TOOLS & SOFTWARE	SUPPORT & COMMUNITY
AMC1106E05	<a href="#">Click here</a>	<a href="#">Click here</a>	<a href="#">Click here</a>	<a href="#">Click here</a>	<a href="#">Click here</a>
AMC1106M05	<a href="#">Click here</a>	<a href="#">Click here</a>	<a href="#">Click here</a>	<a href="#">Click here</a>	<a href="#">Click here</a>

### 12.4 Receiving Notification of Documentation Updates

To receive notification of documentation updates, navigate to the device product folder on ti.com. In the upper right corner, click on *Alert me* to register and receive a weekly digest of any product information that has changed. For change details, review the revision history included in any revised document.

### 12.5 Support Resources

TI E2E™ [support forums](#) are an engineer's go-to source for fast, verified answers and design help — straight from the experts. Search existing answers or ask your own question to get the quick design help you need.

Linked content is provided "AS IS" by the respective contributors. They do not constitute TI specifications and do not necessarily reflect TI's views; see TI's [Terms of Use](#).

## 12.6 Trademarks

E2E is a trademark of Texas Instruments.  
All other trademarks are the property of their respective owners.

## 12.7 Electrostatic Discharge Caution



This integrated circuit can be damaged by ESD. Texas Instruments recommends that all integrated circuits be handled with appropriate precautions. Failure to observe proper handling and installation procedures can cause damage.

ESD damage can range from subtle performance degradation to complete device failure. Precision integrated circuits may be more susceptible to damage because very small parametric changes could cause the device not to meet its published specifications.

## 12.8 Glossary

[SLYZ022](#) — *TI Glossary*.

This glossary lists and explains terms, acronyms, and definitions.

## 13 Mechanical, Packaging, and Orderable Information

The following pages include mechanical, packaging, and orderable information. This information is the most current data available for the designated devices. This data is subject to change without notice and revision of this document. For browser-based versions of this data sheet, refer to the left-hand navigation.

**PACKAGING INFORMATION**

Orderable Device	Status (1)	Package Type	Package Drawing	Pins	Package Qty	Eco Plan (2)	Lead finish/ Ball material (6)	MSL Peak Temp (3)	Op Temp (°C)	Device Marking (4/5)	Samples
AMC1106E05DWV	ACTIVE	SOIC	DWV	8	64	RoHS & Green	NIPDAU	Level-3-260C-168 HR	-40 to 125	1106E05	<a href="#">Samples</a>
AMC1106E05DWVR	ACTIVE	SOIC	DWV	8	1000	RoHS & Green	NIPDAU	Level-3-260C-168 HR	-40 to 125	1106E05	<a href="#">Samples</a>
AMC1106M05DWV	ACTIVE	SOIC	DWV	8	64	RoHS & Green	NIPDAU	Level-3-260C-168 HR	-40 to 125	1106M05	<a href="#">Samples</a>
AMC1106M05DWVR	ACTIVE	SOIC	DWV	8	1000	RoHS & Green	NIPDAU	Level-3-260C-168 HR	-40 to 125	1106M05	<a href="#">Samples</a>

(1) The marketing status values are defined as follows:

**ACTIVE:** Product device recommended for new designs.

**LIFEBUY:** TI has announced that the device will be discontinued, and a lifetime-buy period is in effect.

**NRND:** Not recommended for new designs. Device is in production to support existing customers, but TI does not recommend using this part in a new design.

**PREVIEW:** Device has been announced but is not in production. Samples may or may not be available.

**OBSOLETE:** TI has discontinued the production of the device.

(2) **RoHS:** TI defines "RoHS" to mean semiconductor products that are compliant with the current EU RoHS requirements for all 10 RoHS substances, including the requirement that RoHS substance do not exceed 0.1% by weight in homogeneous materials. Where designed to be soldered at high temperatures, "RoHS" products are suitable for use in specified lead-free processes. TI may reference these types of products as "Pb-Free".

**RoHS Exempt:** TI defines "RoHS Exempt" to mean products that contain lead but are compliant with EU RoHS pursuant to a specific EU RoHS exemption.

**Green:** TI defines "Green" to mean the content of Chlorine (Cl) and Bromine (Br) based flame retardants meet JS709B low halogen requirements of <=1000ppm threshold. Antimony trioxide based flame retardants must also meet the <=1000ppm threshold requirement.

(3) MSL, Peak Temp. - The Moisture Sensitivity Level rating according to the JEDEC industry standard classifications, and peak solder temperature.

(4) There may be additional marking, which relates to the logo, the lot trace code information, or the environmental category on the device.

(5) Multiple Device Markings will be inside parentheses. Only one Device Marking contained in parentheses and separated by a "-" will appear on a device. If a line is indented then it is a continuation of the previous line and the two combined represent the entire Device Marking for that device.

(6) Lead finish/Ball material - Orderable Devices may have multiple material finish options. Finish options are separated by a vertical ruled line. Lead finish/Ball material values may wrap to two lines if the finish value exceeds the maximum column width.

**Important Information and Disclaimer:**The information provided on this page represents TI's knowledge and belief as of the date that it is provided. TI bases its knowledge and belief on information provided by third parties, and makes no representation or warranty as to the accuracy of such information. Efforts are underway to better integrate information from third parties. TI has taken and

continues to take reasonable steps to provide representative and accurate information but may not have conducted destructive testing or chemical analysis on incoming materials and chemicals. TI and TI suppliers consider certain information to be proprietary, and thus CAS numbers and other limited information may not be available for release.

In no event shall TI's liability arising out of such information exceed the total purchase price of the TI part(s) at issue in this document sold by TI to Customer on an annual basis.



## TAPE AND REEL INFORMATION



### QUADRANT ASSIGNMENTS FOR PIN 1 ORIENTATION IN TAPE



\*All dimensions are nominal

Device	Package Type	Package Drawing	Pins	SPQ	Reel Diameter (mm)	Reel Width W1 (mm)	A0 (mm)	B0 (mm)	K0 (mm)	P1 (mm)	W (mm)	Pin1 Quadrant
AMC1106E05DWVR	SOIC	DWV	8	1000	330.0	16.4	12.05	6.15	3.3	16.0	16.0	Q1
AMC1106M05DWVR	SOIC	DWV	8	1000	330.0	16.4	12.05	6.15	3.3	16.0	16.0	Q1

**TAPE AND REEL BOX DIMENSIONS**


\*All dimensions are nominal

Device	Package Type	Package Drawing	Pins	SPQ	Length (mm)	Width (mm)	Height (mm)
AMC1106E05DWVR	SOIC	DWV	8	1000	350.0	350.0	43.0
AMC1106M05DWVR	SOIC	DWV	8	1000	350.0	350.0	43.0

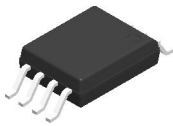
**TUBE**


\*All dimensions are nominal

Device	Package Name	Package Type	Pins	SPQ	L (mm)	W (mm)	T (μm)	B (mm)
AMC1106E05DWV	DWV	SOIC	8	64	505.46	13.94	4826	6.6
AMC1106M05DWV	DWV	SOIC	8	64	505.46	13.94	4826	6.6

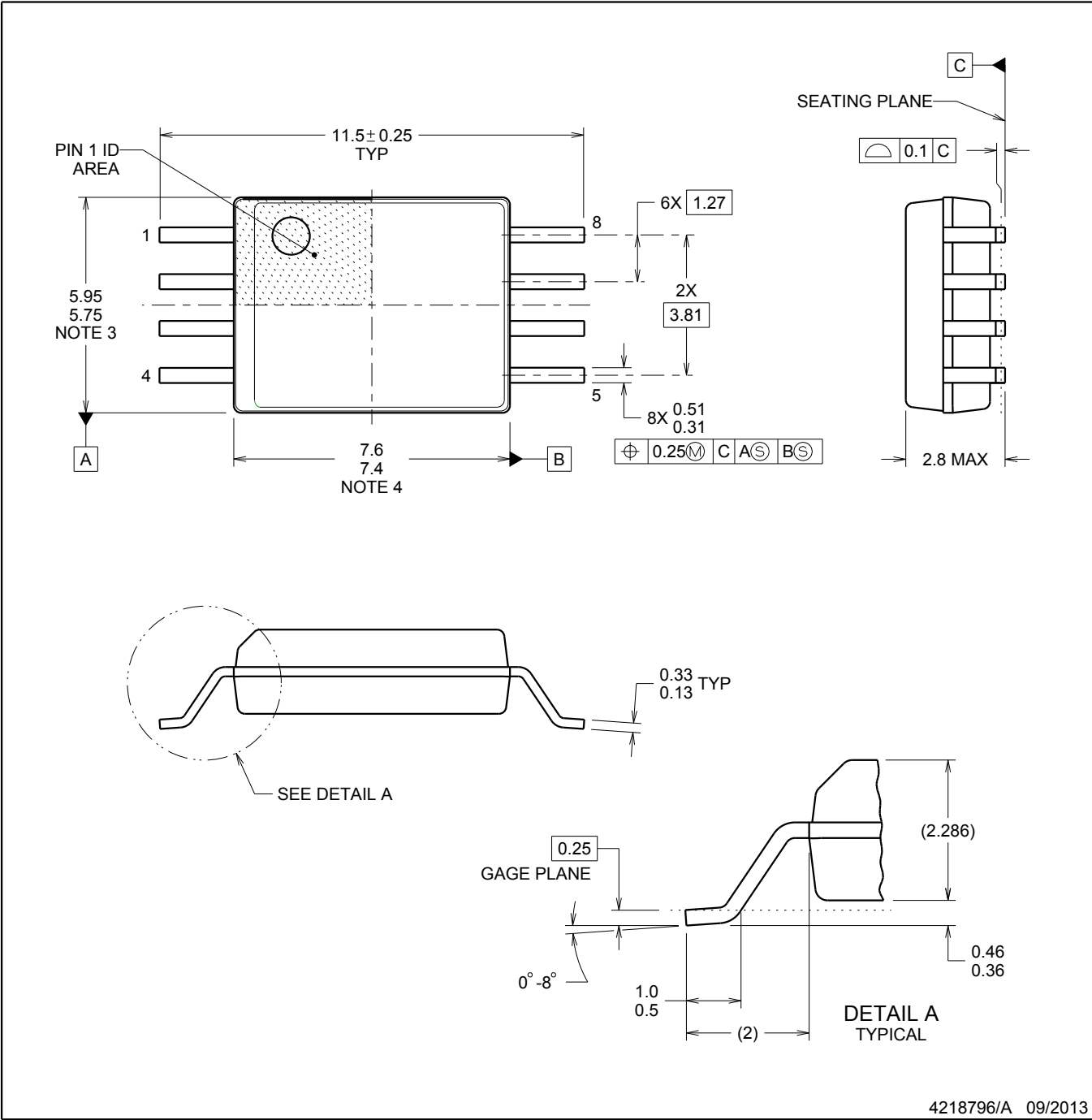
# PACKAGE OUTLINE

DWV0008A



SOIC - 2.8 mm max height

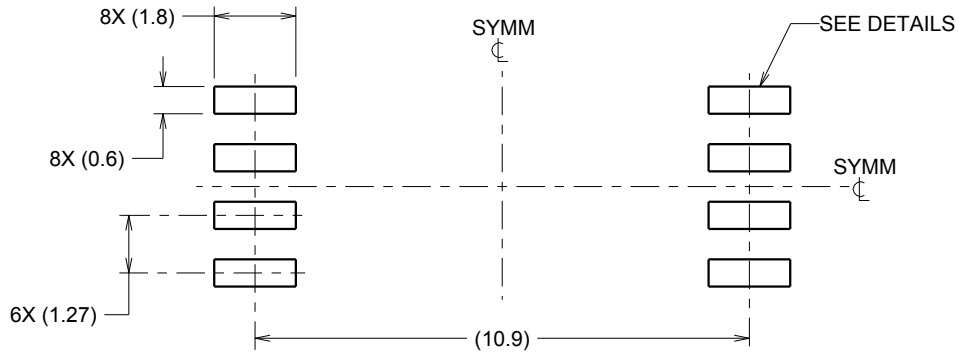
SOIC



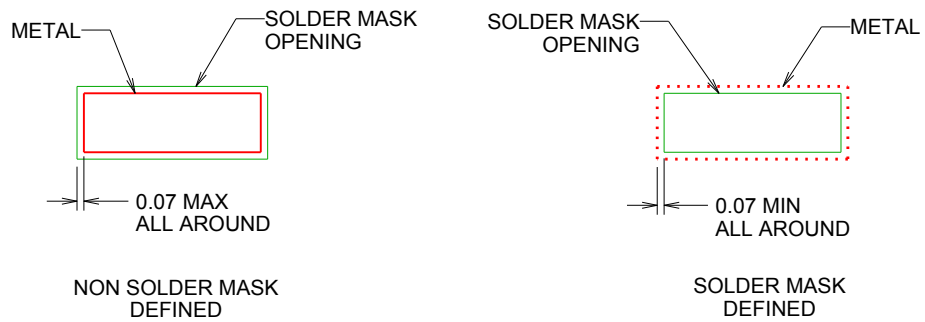
4218796/A 09/2013

**NOTES:**

1. All linear dimensions are in millimeters. Dimensions in parenthesis are for reference only. Dimensioning and tolerancing per ASME Y14.5M.
2. This drawing is subject to change without notice.
3. This dimension does not include mold flash, protrusions, or gate burrs. Mold flash, protrusions, or gate burrs shall not exceed 0.15 mm, per side.
4. This dimension does not include interlead flash. Interlead flash shall not exceed 0.25 mm, per side.



LAND PATTERN EXAMPLE  
 9.1 mm NOMINAL CLEARANCE/CREEPAGE  
 SCALE:6X

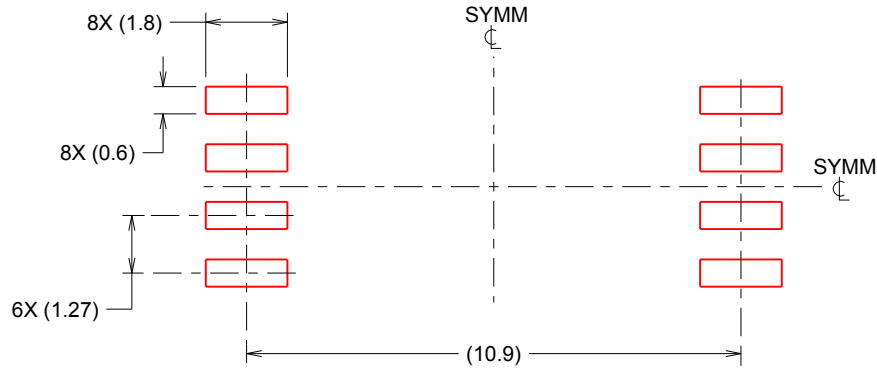


SOLDER MASK DETAILS

4218796/A 09/2013

NOTES: (continued)

- 5. Publication IPC-7351 may have alternate designs.
- 6. Solder mask tolerances between and around signal pads can vary based on board fabrication site.



SOLDER PASTE EXAMPLE  
 BASED ON 0.125 mm THICK STENCIL  
 SCALE:6X

4218796/A 09/2013

NOTES: (continued)

- 7. Laser cutting apertures with trapezoidal walls and rounded corners may offer better paste release. IPC-7525 may have alternate design recommendations.
- 8. Board assembly site may have different recommendations for stencil design.

## IMPORTANT NOTICE AND DISCLAIMER

TI PROVIDES TECHNICAL AND RELIABILITY DATA (INCLUDING DATA SHEETS), DESIGN RESOURCES (INCLUDING REFERENCE DESIGNS), APPLICATION OR OTHER DESIGN ADVICE, WEB TOOLS, SAFETY INFORMATION, AND OTHER RESOURCES "AS IS" AND WITH ALL FAULTS, AND DISCLAIMS ALL WARRANTIES, EXPRESS AND IMPLIED, INCLUDING WITHOUT LIMITATION ANY IMPLIED WARRANTIES OF MERCHANTABILITY, FITNESS FOR A PARTICULAR PURPOSE OR NON-INFRINGEMENT OF THIRD PARTY INTELLECTUAL PROPERTY RIGHTS.

These resources are intended for skilled developers designing with TI products. You are solely responsible for (1) selecting the appropriate TI products for your application, (2) designing, validating and testing your application, and (3) ensuring your application meets applicable standards, and any other safety, security, regulatory or other requirements.

These resources are subject to change without notice. TI grants you permission to use these resources only for development of an application that uses the TI products described in the resource. Other reproduction and display of these resources is prohibited. No license is granted to any other TI intellectual property right or to any third party intellectual property right. TI disclaims responsibility for, and you will fully indemnify TI and its representatives against, any claims, damages, costs, losses, and liabilities arising out of your use of these resources.

TI's products are provided subject to [TI's Terms of Sale](#) or other applicable terms available either on [ti.com](http://ti.com) or provided in conjunction with such TI products. TI's provision of these resources does not expand or otherwise alter TI's applicable warranties or warranty disclaimers for TI products.

TI objects to and rejects any additional or different terms you may have proposed.

Mailing Address: Texas Instruments, Post Office Box 655303, Dallas, Texas 75265  
Copyright © 2022, Texas Instruments Incorporated