

Silicon Carbide (SiC) Module – EliteSiC, 40 mohm SiC M1 MOSFET, 1200 V + 40 A, 1200 V SiC Diode, Two Channel Full SiC Boost, Q0 Package

NXH40B120MNQ0SNG

Description

The NXH40B120MNQ0SNG is a power module containing a dual boost stage. The integrated SiC MOSFETs and SiC Diodes provide lower conduction losses and switching losses, enabling designers to achieve high efficiency and superior reliability.

Features

- 1200 V, 40 mΩ SiC MOSFETs
- Low Reverse Recovery and Fast Switching SiC Diodes
- 1200 V Bypass and Anti-parallel Diodes
- Low Inductive Layout
- Solder Pins
- Thermistor
- These Device is Pb-Free, Halogen Free and is RoHS Compliant

Typical Applications

- Solar Inverter
- Uninterruptible Power Supplies

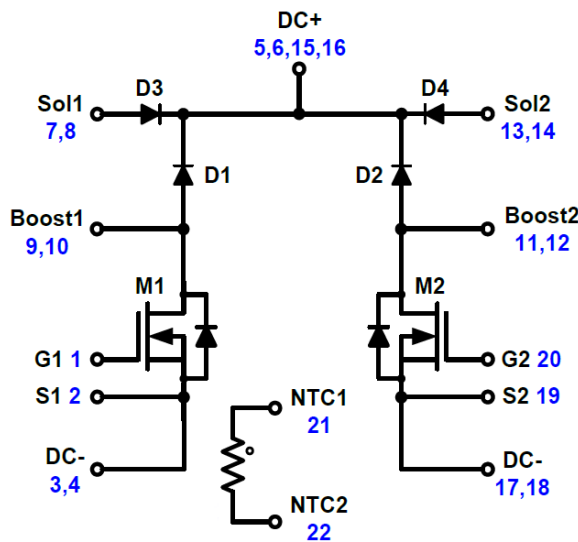
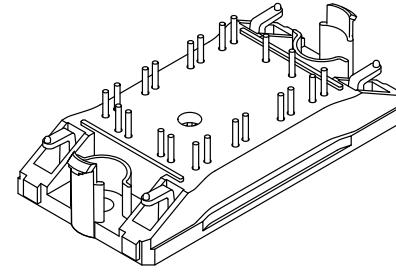
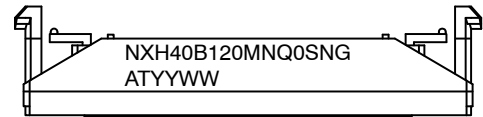

Figure 1. NXH40B120MNQ0SNG Schematic Diagram



Q0BOOST
CASE 180AJ
SOLDER PINS

MARKING DIAGRAM



A = Assembly Site Code
T = Test Site Code
G = Pb-Free Package
YYWW = Year and Work Week Code
NXH40B120MNQ0SNG = Specific Device Code

PIN CONNECTIONS

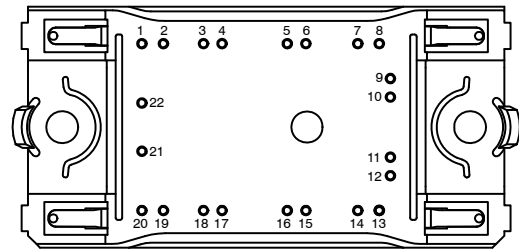

ORDERING INFORMATION

See detailed ordering and shipping information on page 4 of this data sheet.

NXH40B120MNQ0SNG

ABSOLUTE MAXIMUM RATINGS (Note 1) ($T_J = 25^\circ\text{C}$ unless otherwise noted)

Rating	Symbol	Value	Unit
BOOST MOSFET			
Drain–Source Voltage	V_{DS}	1200	V
Gate–Source Voltage	V_{GS}	-15/+25	V
Continuous Drain Current (@ $V_{GS} = 20\text{ V}$, $T_C = 80^\circ\text{C}$)	I_D	38	A
Pulsed Drain Current @ $T_C = 80^\circ\text{C}$ ($T_J = 175^\circ\text{C}$)	$I_{D(Pulse)}$	114	A
Maximum Power Dissipation @ $T_C = 80^\circ\text{C}$ ($T_J = 175^\circ\text{C}$)	P_{tot}	118	W
Minimum Operating Junction Temperature	T_{JMIN}	-40	$^\circ\text{C}$
Maximum Operating Junction Temperature	T_{JMAX}	175	$^\circ\text{C}$

BOOST DIODE

Peak Repetitive Reverse Voltage	V_{RRM}	1200	V
Continuous Forward Current @ $T_C = 80^\circ\text{C}$	I_F	45	A
Repetitive Peak Forward Current ($T_J = 175^\circ\text{C}$, t_p limited by T_{Jmax})	I_{FRM}	135	A
Maximum Power Dissipation @ $T_C = 80^\circ\text{C}$ ($T_J = 175^\circ\text{C}$)	P_{tot}	118	W
Minimum Operating Junction Temperature	T_{JMIN}	-40	$^\circ\text{C}$
Maximum Operating Junction Temperature	T_{JMAX}	175	$^\circ\text{C}$

BYPASS DIODE

Peak Repetitive Reverse Voltage	V_{RRM}	1200	V
Continuous Forward Current @ $T_C = 80^\circ\text{C}$ ($T_J = 150^\circ\text{C}$)	I_F	50	A
Repetitive Peak Forward Current ($T_J = 150^\circ\text{C}$, t_p limited by T_{Jmax})	I_{FRM}	150	A
Power Dissipation Per Diode @ $T_C = 80^\circ\text{C}$ ($T_J = 175^\circ\text{C}$)	P_{tot}	61	W
Minimum Operating Junction Temperature	T_{JMIN}	-40	$^\circ\text{C}$
Maximum Operating Junction Temperature	T_{JMAX}	150	$^\circ\text{C}$

THERMAL PROPERTIES

Storage Temperature Range	T_{stg}	-40 to 125	$^\circ\text{C}$
---------------------------	-----------	------------	------------------

INSULATION PROPERTIES

Isolation Test Voltage, $t = 1\text{ sec}$, 60 Hz	V_{is}	3000	V_{RMS}
Creepage Distance		12.7	mm

Stresses exceeding those listed in the Maximum Ratings table may damage the device. If any of these limits are exceeded, device functionality should not be assumed, damage may occur and reliability may be affected.

1. Refer to ELECTRICAL CHARACTERISTICS, RECOMMENDED OPERATING RANGES and/or APPLICATION INFORMATION for Safe Operating parameters.

RECOMMENDED OPERATING RANGES

Rating	Symbol	Min	Max	Unit
Module Operating Junction Temperature	T_J	-40	($T_{Jmax} - 25$)	$^\circ\text{C}$

Functional operation above the stresses listed in the Recommended Operating Ranges is not implied. Extended exposure to stresses beyond the Recommended Operating Ranges limits may affect device reliability.

NXH40B120MNQ0SNG

ELECTRICAL CHARACTERISTICS (T_J = 25°C unless otherwise noted)

Parameter	Test Conditions	Symbol	Min	Typ	Max	Unit	
BOOST MOSFET CHARACTERISTICS							
Zero Gate Voltage Drain Current	V _{GS} = 0 V, V _{DS} = 1200 V, T _J = 25°C	I _{DSS}	–	–	200	μA	
Static Drain-to-Source On Resistance	V _{GS} = 20 V, I _D = 40 A, T _J = 25°C	R _{DS(on)}	–	40	55	mΩ	
	V _{GS} = 20 V, I _D = 40 A, T _J = 175°C		–	60	–		
Gate-Source Leakage Current	V _{GS} = -15 V / +25 V, V _{DS} = 0 V	I _{GSS}	–	–	1	μA	
Turn-on Delay Time	T _J = 25°C, V _{DS} = 700 V, I _D = 40 A, V _{GS} = -5 V / 20 V, R _G = 4.7 Ω	t _{d(on)}	–	17	–	ns	
Rise Time		t _r	–	7.5	–		
Turn-off Delay Time		t _{d(off)}	–	43.8	–		
Fall Time		t _f	–	17	–		
Turn-on Switching Loss per Pulse		E _{on}	–	255	–		μJ
Turn-off Switching Loss per Pulse		E _{off}	–	125.5	–		μJ
Turn-on Delay Time	T _J = 125°C, V _{DS} = 700 V, I _D = 40 A, V _{GS} = -5 V / 20 V, R _G = 4.7 Ω	t _{d(on)}	–	15.8	–	ns	
Rise Time		t _r	–	7	–		
Turn-off Delay Time		t _{d(off)}	–	46.5	–		
Fall Time		t _f	–	13.5	–		
Turn-on Switching Loss per Pulse		E _{on}	–	383	–		μJ
Turn-off Switching Loss per Pulse		E _{off}	–	108.5	–		μJ
Input Capacitance	V _{DS} = 20 V, V _{GS} = 0 V, f = 1 MHz	C _{ies}	–	3227	–	pF	
Output Capacitance		C _{oes}	–	829	–	pF	
Reverse Transfer Capacitance		C _{res}	–	19	–	pF	
Total Gate Charge	V _{DS} = 600 V, I _D = 20 A, V _{GS} = 20 V, -15 V	Q _g	–	146.72	–	nC	
Thermal Resistance – Chip-to-Case	Thermal grease, Thickness = 2.1 Mil ±2% λ = 2.9 W/mK	R _{thJC}	–	0.81	–	K/W	
Thermal Resistance – Chip-to-Heatsink		R _{thJH}	–	1.26	–	K/W	
BOOST DIODE CHARACTERISTICS							
Diode Reverse Leakage Current	V _R = 1200 V	I _R	–	–	400	μA	
Diode Forward Voltage	I _F = 40 A, T _J = 25°C	V _F	–	1.50	1.75	V	
	I _F = 40 A, T _J = 175°C		–	2.17	–		
Reverse Recovery Time	T _J = 25°C V _{DS} = 700 V, I _D = 40 A V _{GS} = -5 V / 20 V, R _G = 4.7 Ω	t _{rr}	–	16.7	–	ns	
Reverse Recovery Charge		Q _{rr}	–	329.6	–	nC	
Peak Reverse Recovery Current		I _{RRM}	–	34.3	–	A	
Peak Rate of Fall of Recovery Current		di/dt	–	6684	–	A/μs	
Reverse Recovery Energy		E _{rr}	–	176.6	–	μJ	

NXH40B120MNQ0SNG

ELECTRICAL CHARACTERISTICS ($T_J = 25^\circ\text{C}$ unless otherwise noted) (continued)

Parameter	Test Conditions	Symbol	Min	Typ	Max	Unit
-----------	-----------------	--------	-----	-----	-----	------

BOOST DIODE CHARACTERISTICS

Reverse Recovery Time	$T_J = 125^\circ\text{C}$ $V_{DS} = 700\text{ V}$, $I_D = 40\text{ A}$ $V_{GS} = -5\text{ V} / 20\text{ V}$, $R_G = 4.7\ \Omega$	t_{rr}	–	16.9	–	ns
Reverse Recovery Charge		Q_{rr}	–	361	–	nC
Peak Reverse Recovery Current		I_{RRM}	–	37	–	A
Peak Rate of Fall of Recovery Current		di/dt	–	8067	–	A/ μs
Reverse Recovery Energy		E_{rr}	–	209.1	–	μJ
Thermal Resistance – Chip-to-Case	Thermal grease, Thickness = 2.1 Mil $\pm 2\%$ $\lambda = 2.9\text{ W/mK}$	R_{thJC}	–	0.70	–	K/W
Thermal Resistance – Chip-to-Heatsink		R_{thJH}	–	1.14	–	K/W

BYPASS DIODE CHARACTERISTICS

Diode Reverse Leakage Current	$V_R = 1200\text{ V}$, $T_J = 25^\circ\text{C}$	I_R	–	–	250	μA
Diode Forward Voltage	$I_F = 50\text{ A}$, $T_J = 25^\circ\text{C}$	V_F	–	1.11	1.3	V
	$I_F = 50\text{ A}$, $T_J = 150^\circ\text{C}$		–	1.00	–	
Thermal Resistance – Chip-to-Case	Thermal grease, Thickness = 2.1 Mil $\pm 2\%$ $\lambda = 2.9\text{ W/mK}$	R_{thJC}	–	1.15	–	K/W
Thermal Resistance – Chip-to-Heatsink		R_{thJH}	–	1.75	–	K/W

THERMISTOR CHARACTERISTICS

Nominal Resistance		R_{25}	–	22	–	k Ω
Nominal Resistance	$T = 100^\circ\text{C}$	R_{100}	–	1486	–	Ω
Deviation of R25		$\Delta R/R$	–5	–	5	%
Power Dissipation		P_D	–	200	–	mW
Power Dissipation Constant			–	2	–	mW/K
B-value	B (25/50), tolerance $\pm 3\%$		–	3950	–	K
B-value	B (25/100), tolerance $\pm 3\%$		–	3998	–	K

Product parametric performance is indicated in the Electrical Characteristics for the listed test conditions, unless otherwise noted. Product performance may not be indicated by the Electrical Characteristics if operated under different conditions.

PACKAGE MARKING AND ORDERING INFORMATION

Orderable Part Number	Marking	Package	Shipping
NXH40B120MNQ0SNG	NXH40B120MNQ0SNG	Q0PACK – Case 180AJ (Pb-Free and Halide-Free Solder Pins)	24 Units / Blister Tray

NXH40B120MNQ0SNG

TYPICAL CHARACTERISTICS – MOSFET, BOOST DIODE AND BYPASS DIODE

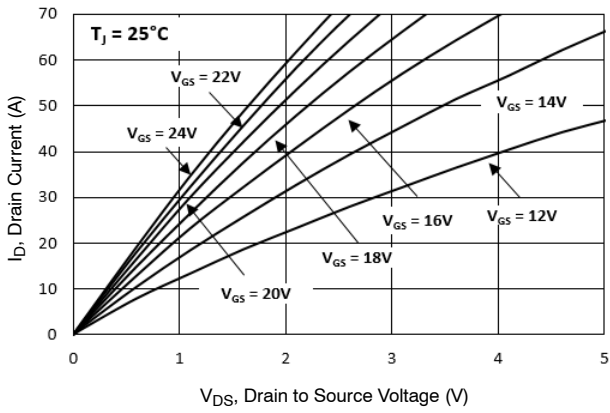

Figure 2. MOSFET on Region Characteristics

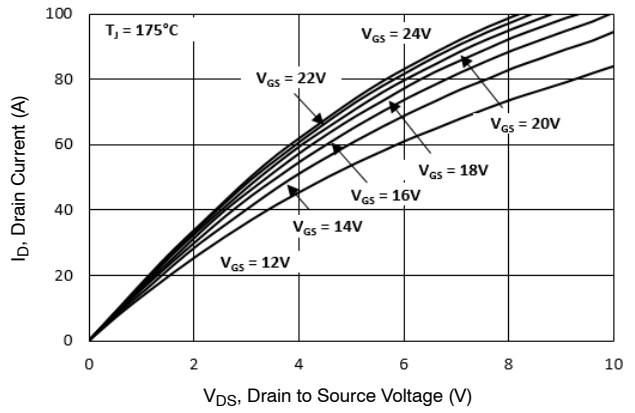

Figure 3. MOSFET on Region Characteristics

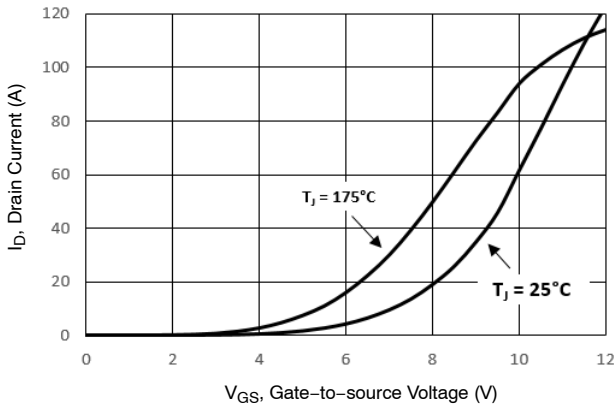

Figure 4. MOSFET Transfer Characteristics

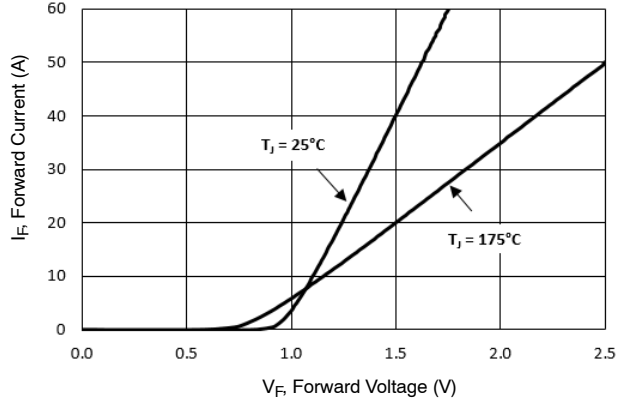

Figure 5. Boost Diode Forward Characteristics

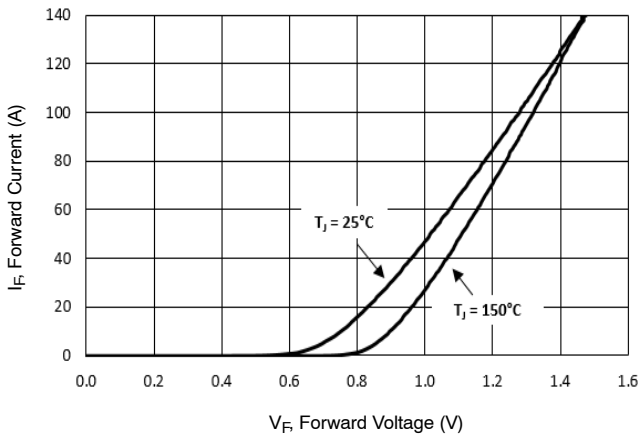

Figure 6. Bypass Diode Forward Characteristics

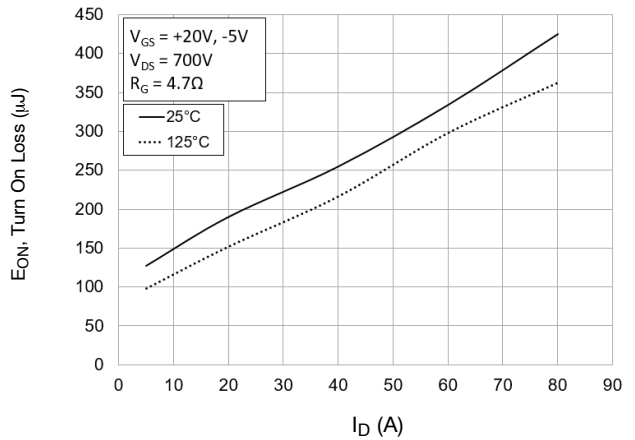

Figure 7. Typical Turn On Loss vs. I_D

NXH40B120MNQ0SNG

TYPICAL CHARACTERISTICS – MOSFET, BOOST DIODE AND BYPASS DIODE (continued)

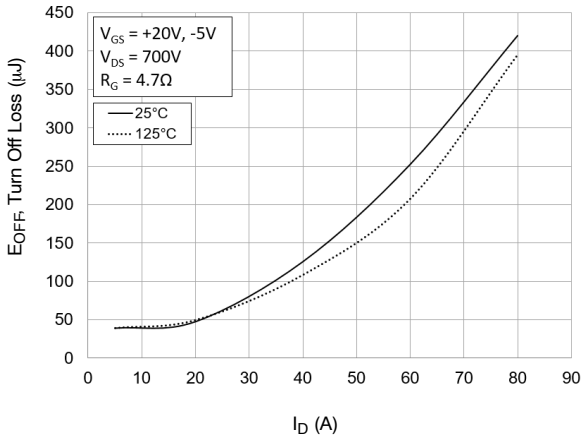

Figure 8. Typical Turn Off Loss vs. I_D

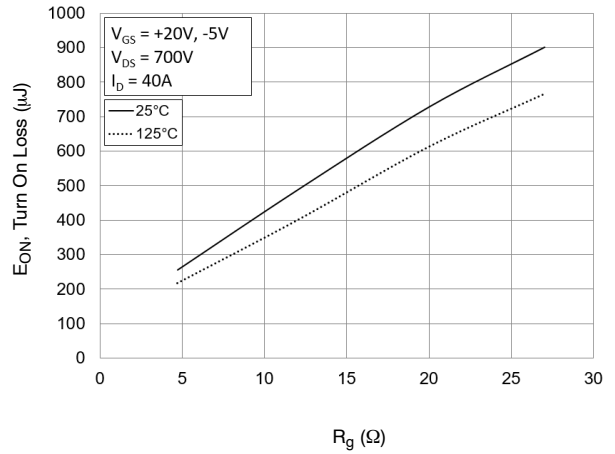

Figure 9. Typical Turn On Loss vs. R_G

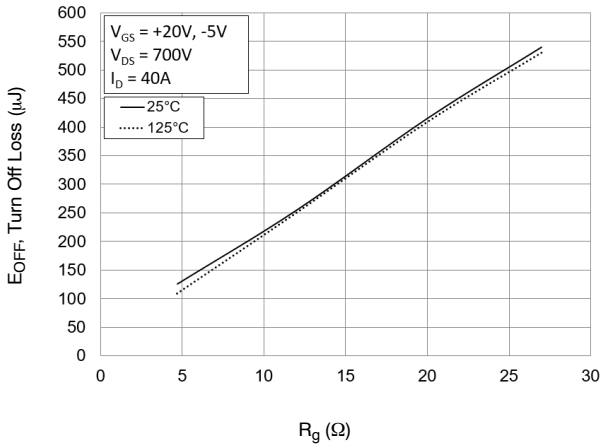

Figure 10. Typical Turn Off Loss vs. R_G

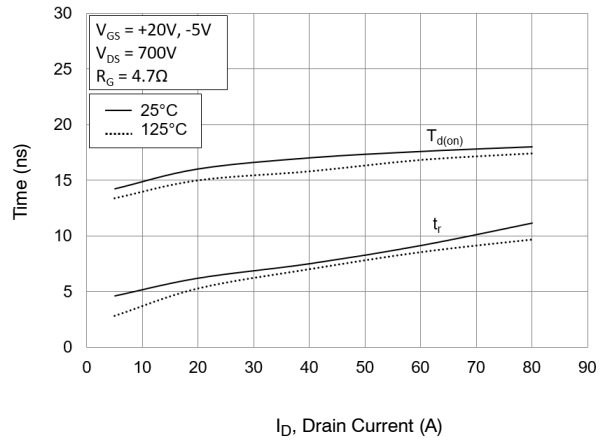

Figure 11. Typical Turn-On Switching Time vs. I_D

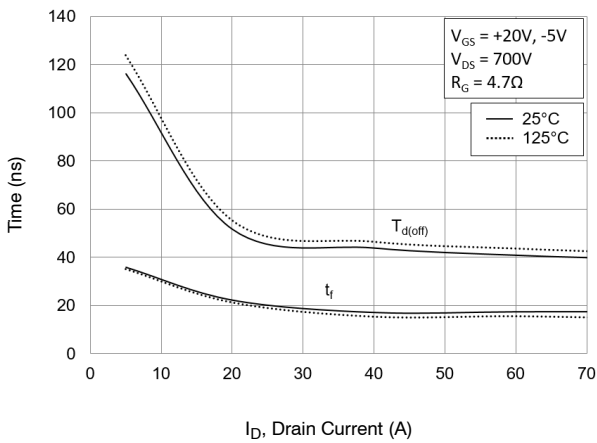

Figure 12. Typical Turn-Off Switching Time vs. I_D

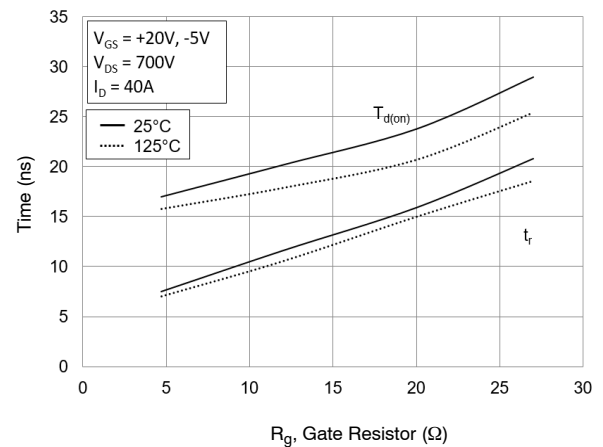

Figure 13. Typical Turn-On Switching Time vs. R_G

NXH40B120MNQ0SNG

TYPICAL CHARACTERISTICS – MOSFET, BOOST DIODE AND BYPASS DIODE (continued)

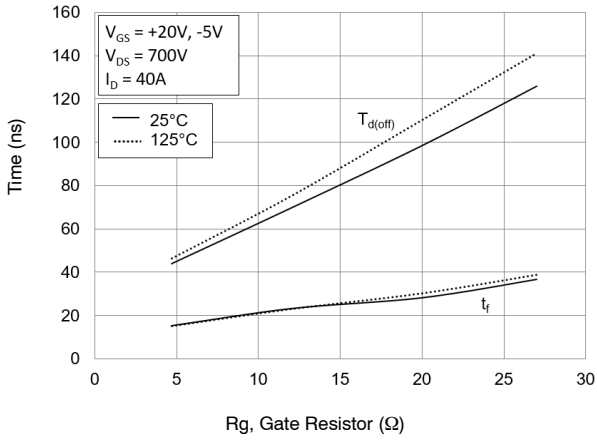

Figure 14. Typical Turn-Off Switching Time vs. R_G

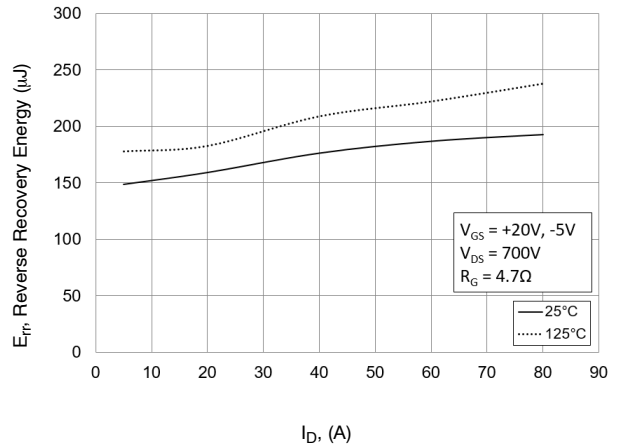

Figure 15. Typical Reverse Recovery Energy Loss vs. I_D

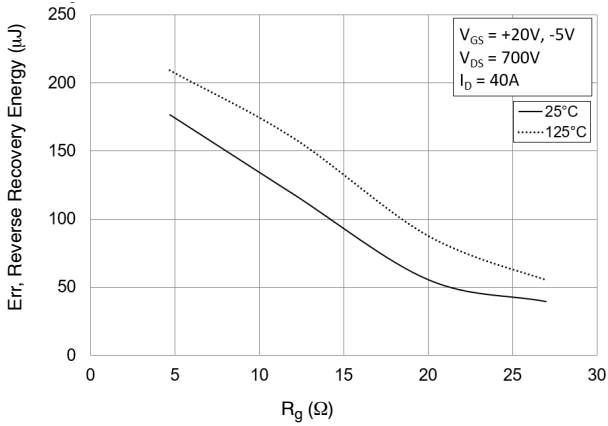

Figure 16. Typical Reverse Recovery Energy Loss vs. R_G

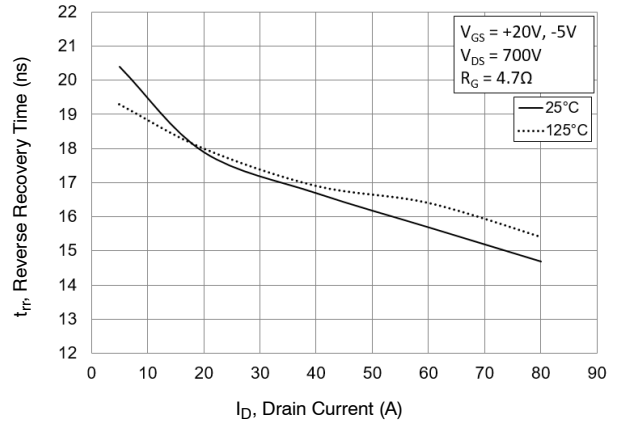

Figure 17. Typical Reverse Recovery Time vs. I_D

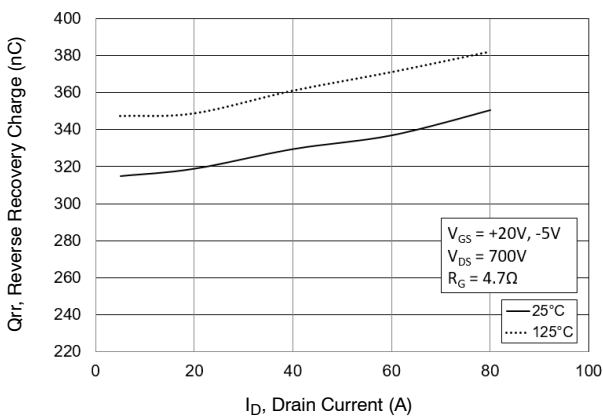

Figure 18. Typical Reverse Recovery Charge vs. I_D

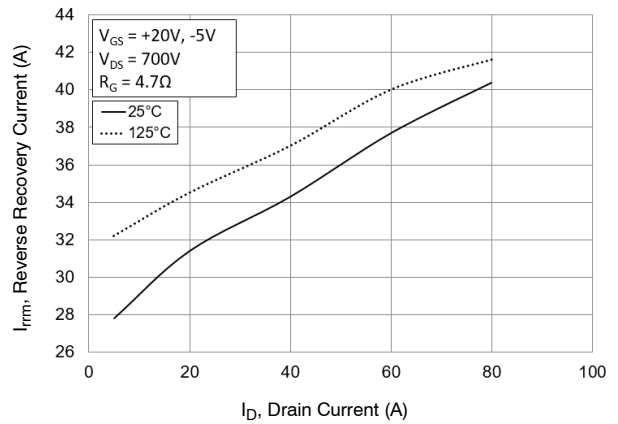

Figure 19. Typical Reverse Recovery Peak Current vs. I_D

NXH40B120MNQ0SNG

TYPICAL CHARACTERISTICS – MOSFET, BOOST DIODE AND BYPASS DIODE (continued)

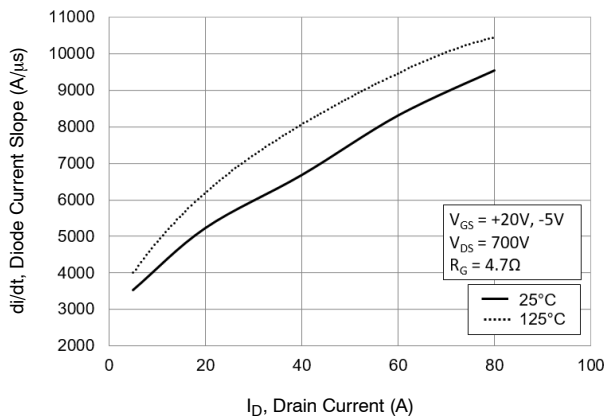

Figure 20. Typical di/dt Current Slope vs. I_D

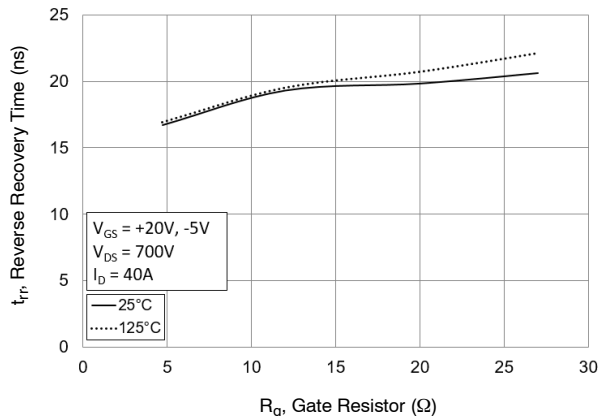

Figure 21. Typical Reverse Recovery Time vs. R_G

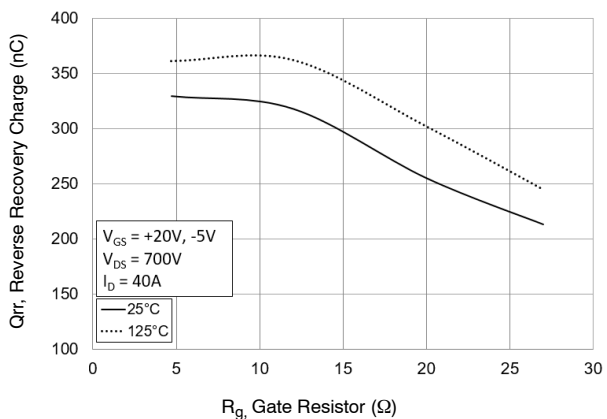

Figure 22. Typical Reverse Recovery Charge vs. R_G

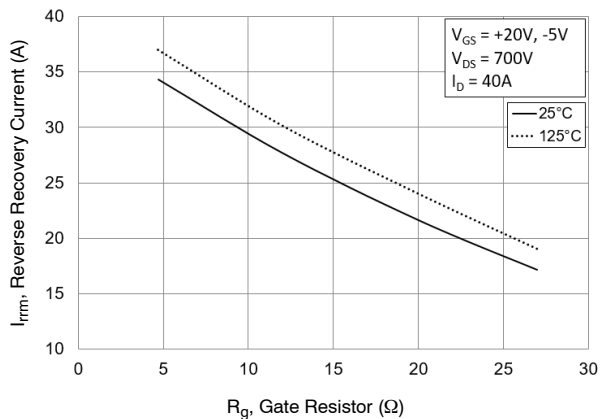

Figure 23. Typical Reverse Recovery Peak Current vs. R_G

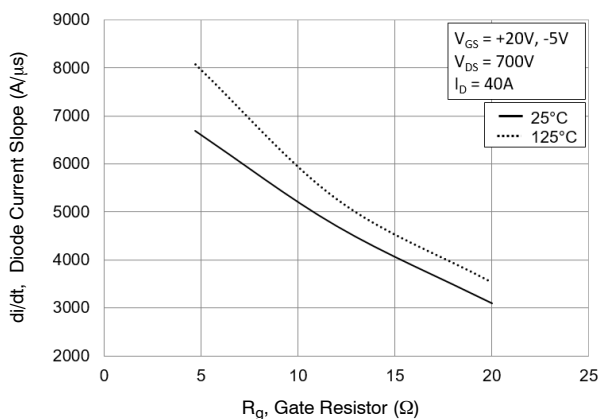

Figure 24. Typical di/dt vs. R_G

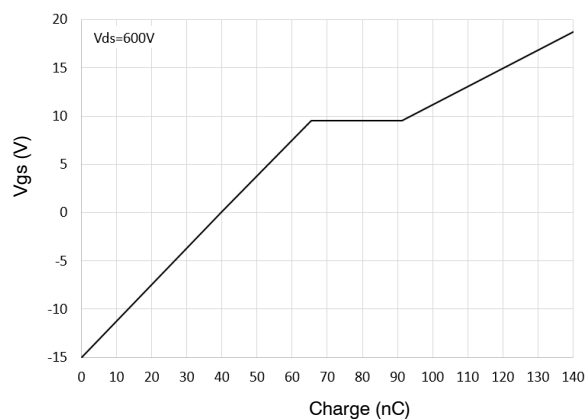

Figure 25. Gate Voltage vs. Gate Charge

NXH40B120MNQ0SNG

TYPICAL CHARACTERISTICS – MOSFET, BOOST DIODE AND BYPASS DIODE (continued)

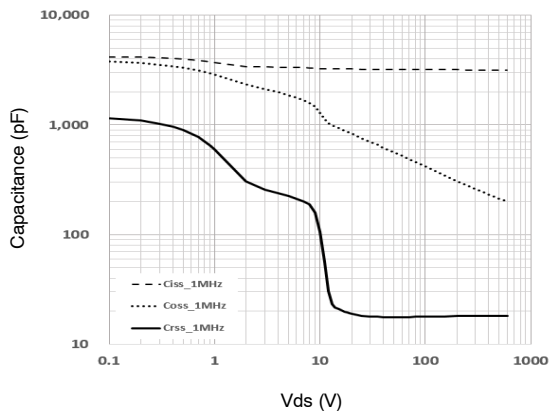

Figure 26. Capacitance Charge

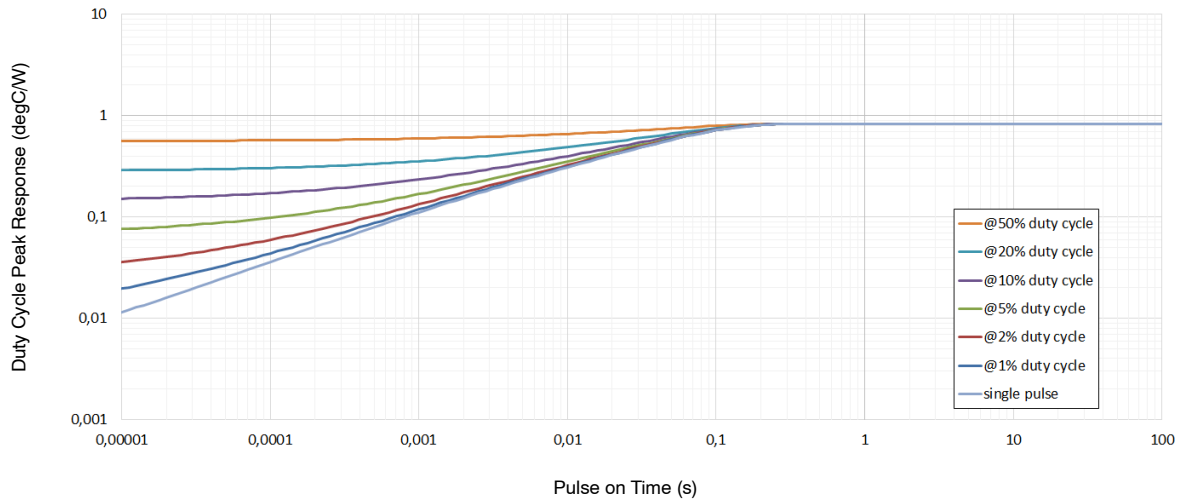

Figure 27. Mosfet Transient Thermal Impedance

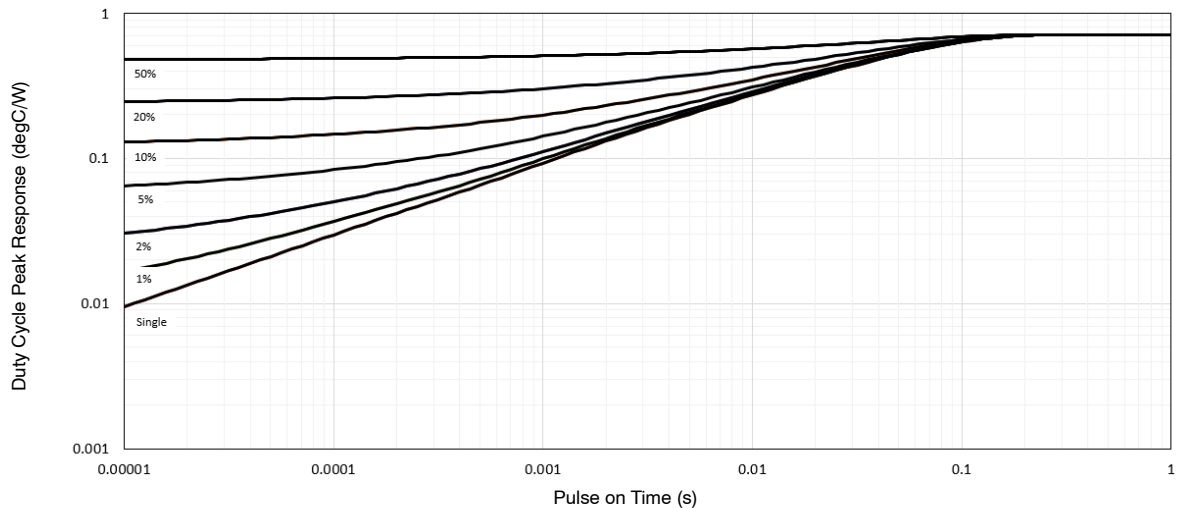

Figure 28. Boost Diode Transient Thermal Impedance

NXH40B120MNQ0SNG

TYPICAL CHARACTERISTICS – MOSFET, BOOST DIODE AND BYPASS DIODE (continued)

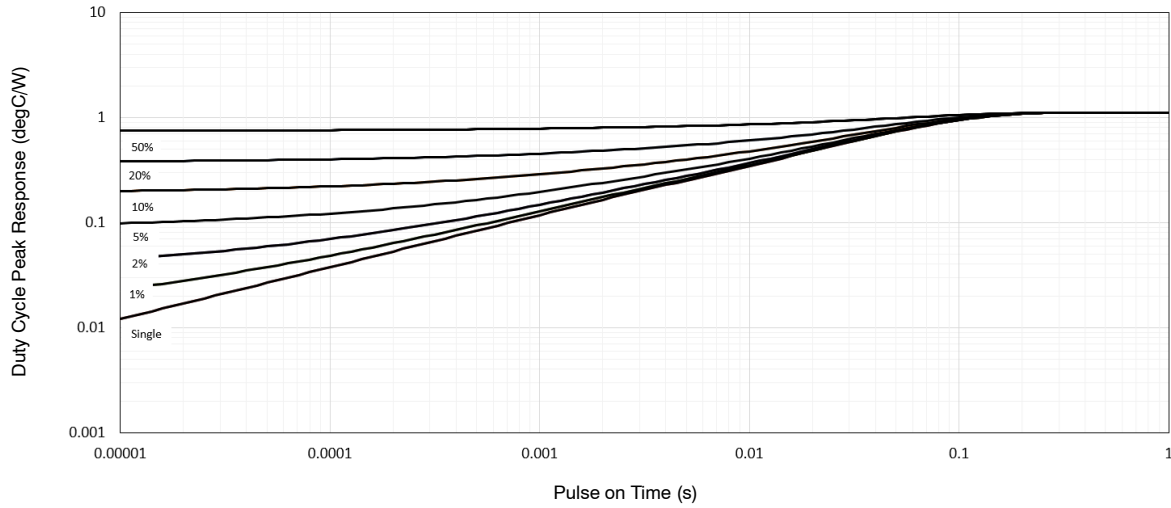

Figure 29. Bypass Diode Transient Thermal Impedance

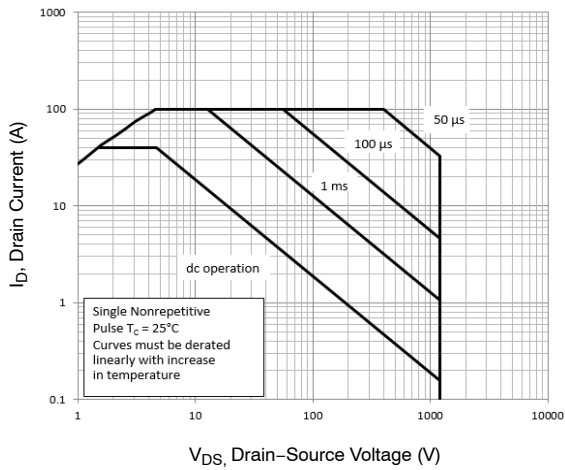

Figure 30. FBSOA for MOSFET

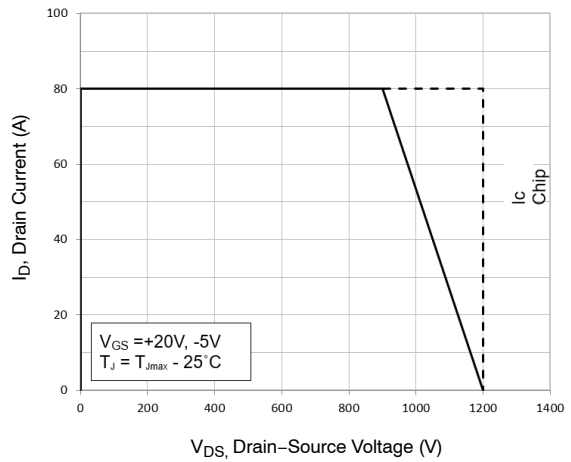

Figure 31. RBSOA for MOSFET

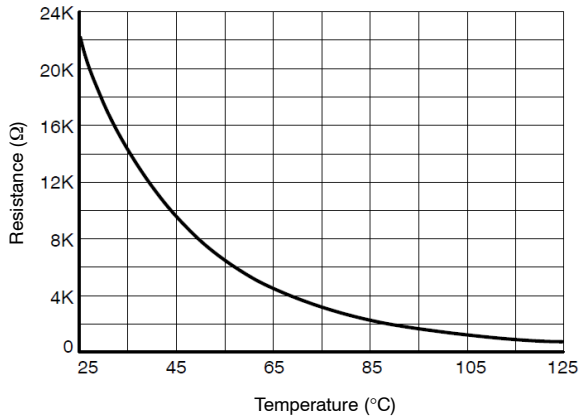

Figure 32. Thermistor Characteristics

MECHANICAL CASE OUTLINE

PACKAGE DIMENSIONS

ON Semiconductor®



PIM22, 55x32.5 / Q0BOOST CASE 180AJ ISSUE B

DATE 08 NOV 2017

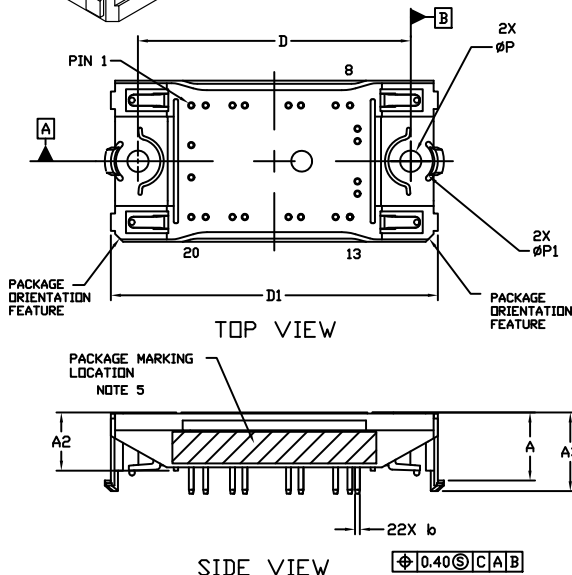
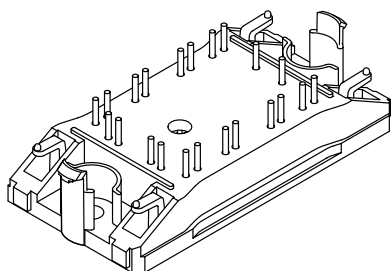

NOTES:

1. DIMENSIONING AND TOLERANCING PER ASME Y14.5M, 2009.
2. CONTROLLING DIMENSION: MILLIMETERS
3. DIMENSION b APPLIES TO THE PLATED TERMINALS AND IS MEASURED BETWEEN 1.00 AND 3.00 FROM THE TERMINAL TIP.
4. POSITION OF THE CENTER OF THE TERMINALS IS DETERMINED FROM DATUM B THE CENTER OF DIMENSION D, X DIRECTION, AND FROM DATUM A, Y DIRECTION. POSITIONAL TOLERANCE, AS NOTED IN DRAWING, APPLIES TO EACH TERMINAL IN BOTH DIRECTIONS.
5. PACKAGE MARKING IS LOCATED AS SHOWN ON THE SIDE OPPOSITE THE PACKAGE ORIENTATION FEATURES.

DIM	MILLIMETERS	
	MIN.	NDM.
A	13.50	13.90
A1	0.10	0.30
A2	11.50	11.90
A3	15.65	16.05
A4	16.35	REF
b	0.95	1.05
D	54.80	55.20
D1	65.60	66.20
E	32.20	32.80
P	4.20	4.40
P1	8.90	9.10

MOUNTING HOLE POSITION

NOTE 4

PIN	HOLE POSITION		PIN	PIN POSITION		PIN	PIN POSITION		PIN	PIN POSITION	
	X	Y		X	Y		X	Y		X	Y
1	-16.75	-11.25	12	16.75	6.55	1	-16.75	11.25	12	16.75	-6.55
2	-13.85	-11.25	13	15.25	11.25	2	-13.85	11.25	13	15.25	-11.25
3	-8.45	-11.25	14	12.35	11.25	3	-8.45	11.25	14	12.35	-11.25
4	-5.95	-11.25	15	5.35	11.25	4	-5.95	11.25	15	5.35	-11.25
5	2.85	-11.25	16	2.85	11.25	5	2.85	11.25	16	2.85	-11.25
6	5.35	-11.25	17	-5.95	11.25	6	5.35	11.25	17	-5.95	-11.25
7	12.35	-11.25	18	-8.45	11.25	7	12.35	11.25	18	-8.45	-11.25
8	15.25	-11.25	19	-13.85	11.25	8	15.25	11.25	19	-13.85	-11.25
9	16.75	-6.55	20	-16.75	11.25	9	16.75	6.55	20	-16.75	-11.25
10	16.75	-4.05	21	-16.75	3.25	10	16.75	4.05	21	-16.75	-3.25
11	16.75	4.05	22	-16.75	-3.25	11	16.75	-4.05	22	-16.75	3.25

GENERIC MARKING DIAGRAM*

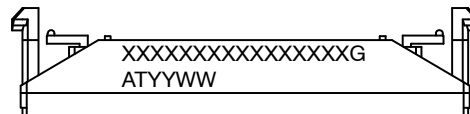

XXXXX = Specific Device Code
 G = Pb-Free Package
 AT = Assembly & Test Site Code
 YYWW = Year and Work Week Code

*This information is generic. Please refer to device data sheet for actual part marking. Pb-Free indicator, "G" or microdot "•", may or may not be present. Some products may not follow the Generic Marking.

DOCUMENT NUMBER:	98AON63481G	Electronic versions are uncontrolled except when accessed directly from the Document Repository. Printed versions are uncontrolled except when stamped "CONTROLLED COPY" in red.
DESCRIPTION:	PIM22 55X32.5 / Q0BOOST (SOLDER PIN)	PAGE 1 OF 2

ON Semiconductor and ON are trademarks of Semiconductor Components Industries, LLC dba ON Semiconductor or its subsidiaries in the United States and/or other countries. ON Semiconductor reserves the right to make changes without further notice to any products herein. ON Semiconductor makes no warranty, representation or guarantee regarding the suitability of its products for any particular purpose, nor does ON Semiconductor assume any liability arising out of the application or use of any product or circuit, and specifically disclaims any and all liability, including without limitation special, consequential or incidental damages. ON Semiconductor does not convey any license under its patent rights nor the rights of others.

PIM22, 55x32.5 / Q0BOOST
CASE 180AJ
ISSUE B

DATE 08 NOV 2017

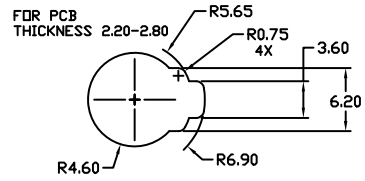
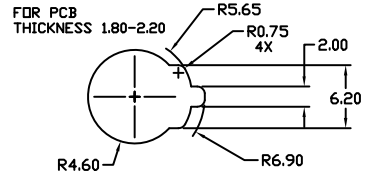
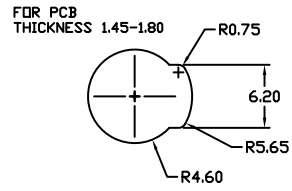
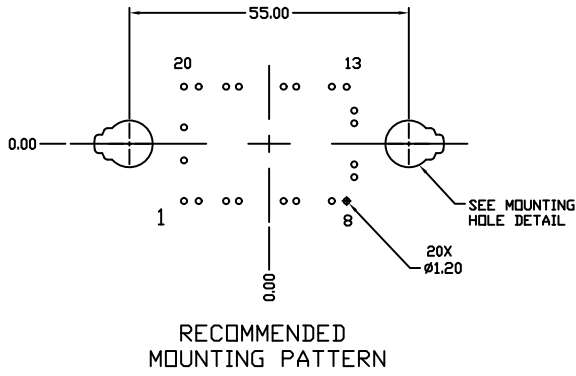

MOUNTING HOLE DETAIL

DOCUMENT NUMBER:	98AON63481G	Electronic versions are uncontrolled except when accessed directly from the Document Repository. Printed versions are uncontrolled except when stamped "CONTROLLED COPY" in red.
DESCRIPTION:	PIM22 55X32.5 / Q0BOOST (SOLDER PIN)	PAGE 2 OF 2

ON Semiconductor and  are trademarks of Semiconductor Components Industries, LLC dba ON Semiconductor or its subsidiaries in the United States and/or other countries. ON Semiconductor reserves the right to make changes without further notice to any products herein. ON Semiconductor makes no warranty, representation or guarantee regarding the suitability of its products for any particular purpose, nor does ON Semiconductor assume any liability arising out of the application or use of any product or circuit, and specifically disclaims any and all liability, including without limitation special, consequential or incidental damages. ON Semiconductor does not convey any license under its patent rights nor the rights of others.

onsemi, **Onsemi**, and other names, marks, and brands are registered and/or common law trademarks of Semiconductor Components Industries, LLC dba "**onsemi**" or its affiliates and/or subsidiaries in the United States and/or other countries. **onsemi** owns the rights to a number of patents, trademarks, copyrights, trade secrets, and other intellectual property. A listing of **onsemi**'s product/patent coverage may be accessed at www.onsemi.com/site/pdf/Patent-Marking.pdf. **onsemi** reserves the right to make changes at any time to any products or information herein, without notice. The information herein is provided "as-is" and **onsemi** makes no warranty, representation or guarantee regarding the accuracy of the information, product features, availability, functionality, or suitability of its products for any particular purpose, nor does **onsemi** assume any liability arising out of the application or use of any product or circuit, and specifically disclaims any and all liability, including without limitation special, consequential or incidental damages. Buyer is responsible for its products and applications using **onsemi** products, including compliance with all laws, regulations and safety requirements or standards, regardless of any support or applications information provided by **onsemi**. "Typical" parameters which may be provided in **onsemi** data sheets and/or specifications can and do vary in different applications and actual performance may vary over time. All operating parameters, including "Typicals" must be validated for each customer application by customer's technical experts. **onsemi** does not convey any license under any of its intellectual property rights nor the rights of others. **onsemi** products are not designed, intended, or authorized for use as a critical component in life support systems or any FDA Class 3 medical devices or medical devices with a same or similar classification in a foreign jurisdiction or any devices intended for implantation in the human body. Should Buyer purchase or use **onsemi** products for any such unintended or unauthorized application, Buyer shall indemnify and hold **onsemi** and its officers, employees, subsidiaries, affiliates, and distributors harmless against all claims, costs, damages, and expenses, and reasonable attorney fees arising out of, directly or indirectly, any claim of personal injury or death associated with such unintended or unauthorized use, even if such claim alleges that **onsemi** was negligent regarding the design or manufacture of the part. **onsemi** is an Equal Opportunity/Affirmative Action Employer. This literature is subject to all applicable copyright laws and is not for resale in any manner.

ADDITIONAL INFORMATION

TECHNICAL PUBLICATIONS:

Technical Library: www.onsemi.com/design/resources/technical-documentation
onsemi Website: www.onsemi.com

ONLINE SUPPORT: www.onsemi.com/support

For additional information, please contact your local Sales Representative at www.onsemi.com/support/sales