

# Data sheet | Item number: 765-4201/100-000

8-Port IO-Link Master Class A; EtherCAT; DC 24 V / 2.0 A; 8xM12 connection; WideLine

[www.wago.com/765-4201/100-000](http://www.wago.com/765-4201/100-000)



*i* Picture differs from the item.

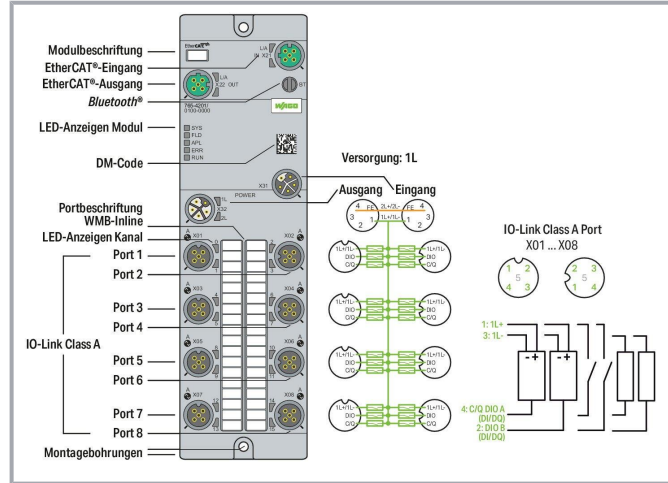

## Data

### Technical data

### Fieldbus

|   |                                     |
|---|-------------------------------------|
| Communication                                 | EtherCAT®<br>AoE, EoE, FoE          |
| Connection technology: communication/fieldbus | 2 x D-coded M12; 4-pole             |
| Interface standard                            | 10BASE-T/100BASE-TX; potential-free |
| Autonegotiation; autocrossover                | yes                                 |

### Device functions

|           |                                |
|-----------|--------------------------------|
| Parameter | Input filter<br>Output current |
|-----------|--------------------------------|

Subject to changes. Please also observe the further product documentation!

WAGO GmbH & Co. KG  
 Hansastr. 27  
 32423 Minden  
 Phone: +49571 887-0 | Fax: +49571 887-169  
 Email: [info.de@wago.com](mailto:info.de@wago.com) | Web: [www.wago.com](http://www.wago.com)

Do you have any questions about our products?  
 We are always happy to take your call at +49 (571) 887-44222.



|                  |  |
|------------------|--|
|                  | Temperature  |
| Diagnostics      | Undervoltage; Overcurrent; Overload; Overtemperature |
| Device functions | Bluetooth®<br>OPC UA Server                          |
| Visualization    | Android/iOS app<br>Web server                        |

### IO-Link master

|                               |  |
|-------------------------------|--|
| IO-Link master classification | Class A; V1.1 specification  |
| Port mode                     | IO-Link: autoconfig, manual, tool-based<br>DI<br>DO  |
| Cycle time                    | 400 µs (min.)  |
| Operating mode                | IO-Link master, DI or DO (adjustable for pin 4 per port); DI or DO (adjustable for pin 2 per port) |

### IO-Link ports

|                                       |   |
|---------------------------------------|---|
| Number of digital inputs              | 16                                      |
| Number of digital outputs             | 16                                      |
| Connection technology: inputs/outputs | 8 x A-coded M12; 5-pole                 |
| Signal type (voltage)                 | 24 VDC                                  |
| Input characteristic                  | High-side switching                     |
| Input filter                          | 0.2 ... 20 ms                           |
| Input characteristic                  | Type 3, per IEC 61131-2                 |
| Output current (per channel)          | 2 A (typ.) for DO                       |
| Supply current per port               | 1L: 1 A for IO-Link; 4 A (max.) for DIO |

### Supply (module)

|                               |  |
|-------------------------------|--|
| Connection technology: supply | 2 x L-coded M12; 5-pole                                |
| Supply voltage                | 24 VDC (18 ... 31.2 V); 1L                             |
| Current consumption (max.)    | 16000 mA   |
| Current consumption (note)    | per supply line; overload- and short-circuit-protected |
| Reverse voltage protection    | Yes  |

### Physical data

|        |                       |
|--------|-----------------------|
| Width  | 60 mm / 2.362 inches  |
| Height | 30 mm / 1.181 inches  |
| Depth  | 210 mm / 8.268 inches |

Subject to changes. Please also observe the further product documentation!

## Mechanical Data

|                    |       |
|--------------------|-------|
| Weight             | 670 g |
| Conformity marking | CE    |

## Environmental requirements

|  |  |
|--|--|
| Ambient temperature (operation)          | -25 ... +70 °C   |
| Ambient temperature (storage)            | -40 ... +80 °C   |
| Protection type                          | IP67   |
| Protection class                         | III per EN 61140, IEC 61140, VDE 0140-1  |
| Operating altitude                       | 0 ... 2000 m / 0 ... 6562 ft   |
| Pollution degree                         | 3 (EN 60664-1)   |
| Overvoltage category                     | II (EN 60664-1)  |
| Relative humidity (without condensation) | 95 %   |
| Vibration resistance                     | 5g per IEC 60068-2-6   |
| Shock resistance                         | Short-term: 50g/11 ms/half-sine per IEC 60068-2-27; Long-term: 30g/6 ms/half-sine per IEC 60068-2-29 |
| EMC immunity to interference             | per EN 61000-6-2   |
| EMC emission of interference             | per EN 61000-6-4   |

## Commercial data

|                       |               |
|-----------------------|---------------|
| ETIM 8.0              | EC001601      |
| ETIM 7.0              | EC001601      |
| PU (SPU)              | 1 pcs         |
| Country of origin     | DE            |
| GTIN                  | 4066966063134 |
| Customs tariff number | 85371098990   |

## Environmental Product Compliance

|                        |                         |
|------------------------|-------------------------|
| RoHS Compliance Status | Compliant, No Exemption |
|------------------------|-------------------------|

## Required accessories

|   |  |
|---|--|
| Cover   |  |
|  | Item no.: 756-8102<br>M12 protective cap; for unused sockets     |
|   | <a href="http://www.wago.com/756-8102">www.wago.com/756-8102</a> |

Subject to changes. Please also observe the further product documentation!

|   |   |  |
|---|---|--|
|  | <b>Item no.: 756-8103</b><br>M12 protective cap; for unused plugs | <a href="http://www.wago.com/756-8103">www.wago.com/756-8103</a> |
|---|---|--|

**Tool**

|   |  |  |
|---|--|--|
| Assembly tool   |  |  |
|  | <b>Item no.: 206-701</b><br>Torque wrench M8 and M12; Assembly kit | <a href="http://www.wago.com/206-701">www.wago.com/206-701</a> |

**Marking accessories**







|  |  |  |
|--|--|--|
| Marking strip  |  |  |
|  | <b>Item no.: 2009-110</b><br>Marking strips; for Smart Printer; on reel; not stretchable; plain; snap-on type; white | <a href="http://www.wago.com/2009-110">www.wago.com/2009-110</a> |

**Marker**











|  |   |  |
|--|---|--|
|  | <b>Item no.: 2009-115</b><br>WMB-Inline; for Smart Printer; 1500 pieces on roll; stretchable 5 - 5.2 mm; plain; snap-on type; white | <a href="http://www.wago.com/2009-115">www.wago.com/2009-115</a> |
|--|---|--|

**Optional accessories**

**Cables and pluggable connectors**

|  |   |  |
|--|---|--|
| Sensor/actuator cable  |   |  |
|   | <b>Item no.: 756-5402/040-010</b><br>Sensor/Actuator cable; M12A socket; straight; M12A plug; angled; 4-pole; Length: 1 m | <a href="http://www.wago.com/756-5402/040-010">www.wago.com/756-5402/040-010</a> |
|  | <b>Item no.: 756-5402/040-020</b><br>Sensor/Actuator cable; M12A socket; straight; M12A plug; angled; 4-pole; Length: 2 m | <a href="http://www.wago.com/756-5402/040-020">www.wago.com/756-5402/040-020</a> |
|  | <b>Item no.: 756-5311/040-050</b><br>Sensor/Actuator cable; M12A plug; straight; 4-pole; Length: 5 m                      | <a href="http://www.wago.com/756-5311/040-050">www.wago.com/756-5311/040-050</a> |
|  | <b>Item no.: 756-5311/040-015</b><br>Sensor/Actuator cable; M12A plug; straight; 4-pole; Length: 1.5 m                    | <a href="http://www.wago.com/756-5311/040-015">www.wago.com/756-5311/040-015</a> |
|  | <b>Item no.: 756-5311/040-100</b><br>Sensor/Actuator cable; M12A plug; straight; 4-pole; Length: 10 m                     | <a href="http://www.wago.com/756-5311/040-100">www.wago.com/756-5311/040-100</a> |
|  | <b>Item no.: 756-5404/040-020</b><br>Sensor/Actuator cable; M12A socket; angled; M12A plug; angled; 4-pole; Length: 2 m   | <a href="http://www.wago.com/756-5404/040-020">www.wago.com/756-5404/040-020</a> |
|  | <b>Item no.: 756-5510/040-010</b><br>Sensor/Actuator cable; M8 socket; angled; M12A plug; angled; 4-pole; Length: 1 m     | <a href="http://www.wago.com/756-5510/040-010">www.wago.com/756-5510/040-010</a> |

Subject to changes. Please also observe the further product documentation!

|  |   |  |
|--|---|--|
|    | <b>Item no.: 756-5510/040-020</b><br>Sensor/Actuator cable; M8 socket; angled; M12A plug; angled; 4-pole; Length: 2 m       | <a href="http://www.wago.com/756-5510/040-020">www.wago.com/756-5510/040-020</a> |
|    | <b>Item no.: 756-5401/040-020</b><br>Sensor/Actuator cable; M12A socket; straight; M12A plug; straight; 4-pole; Length: 2 m | <a href="http://www.wago.com/756-5401/040-020">www.wago.com/756-5401/040-020</a> |
|    | <b>Item no.: 756-5401/040-010</b><br>Sensor/Actuator cable; M12A socket; straight; M12A plug; straight; 4-pole; Length: 1 m | <a href="http://www.wago.com/756-5401/040-010">www.wago.com/756-5401/040-010</a> |
|    | <b>Item no.: 756-5507/040-010</b><br>Sensor/Actuator cable; M8 socket; straight; M12A plug; straight; 4-pole; Length: 1 m   | <a href="http://www.wago.com/756-5507/040-010">www.wago.com/756-5507/040-010</a> |
|    | <b>Item no.: 756-5507/040-020</b><br>Sensor/Actuator cable; M8 socket; straight; M12A plug; straight; 4-pole; Length: 2 m   | <a href="http://www.wago.com/756-5507/040-020">www.wago.com/756-5507/040-020</a> |
|    | <b>Item no.: 756-5404/040-010</b><br>Sensor/Actuator cable; M12A socket; angled; M12A plug; angled; 4-pole; Length: 1 m     | <a href="http://www.wago.com/756-5404/040-010">www.wago.com/756-5404/040-010</a> |
|    | <b>Item no.: 756-5312/040-015</b><br>Sensor/Actuator cable; M12A plug; angled; 4-pole; Length: 1.5 m                        | <a href="http://www.wago.com/756-5312/040-015">www.wago.com/756-5312/040-015</a> |
|  | <b>Item no.: 756-5312/040-050</b><br>Sensor/Actuator cable; M12A plug; angled; 4-pole; Length: 5 m                          | <a href="http://www.wago.com/756-5312/040-050">www.wago.com/756-5312/040-050</a> |
|  | <b>Item no.: 756-5509/040-010</b><br>Sensor/Actuator cable; M8 socket; angled; M12A plug; straight; 4-pole; Length: 1 m     | <a href="http://www.wago.com/756-5509/040-010">www.wago.com/756-5509/040-010</a> |
|  | <b>Item no.: 756-5509/040-020</b><br>Sensor/Actuator cable; M8 socket; angled; M12A plug; straight; 4-pole; Length: 2 m     | <a href="http://www.wago.com/756-5509/040-020">www.wago.com/756-5509/040-020</a> |
|  | <b>Item no.: 756-5403/040-010</b><br>Sensor/Actuator cable; M12A socket; angled; M12A plug; straight; 4-pole; Length: 1 m   | <a href="http://www.wago.com/756-5403/040-010">www.wago.com/756-5403/040-010</a> |
|  | <b>Item no.: 756-5312/040-100</b><br>Sensor/Actuator cable; M12A plug; angled; 4-pole; Length: 10 m                         | <a href="http://www.wago.com/756-5312/040-100">www.wago.com/756-5312/040-100</a> |
|  | <b>Item no.: 756-5403/040-020</b><br>Sensor/Actuator cable; M12A socket; angled; M12A plug; straight; 4-pole; Length: 2 m   | <a href="http://www.wago.com/756-5403/040-020">www.wago.com/756-5403/040-020</a> |

Subject to changes. Please also observe the further product documentation!



**Item no.:** 756-5508/040-010

Sensor/Actuator cable; M8 socket; straight; M12A plug; angled; 4-pole; Length: 1 m

[www.wago.com/756-5508/040-010](http://www.wago.com/756-5508/040-010)



**Item no.:** 756-5508/040-020

Sensor/Actuator cable; M8 socket; straight; M12A plug; angled; 4-pole; Length: 2 m

[www.wago.com/756-5508/040-020](http://www.wago.com/756-5508/040-020)

#### Configurable connectors



**Item no.:** 756-9202/040-000

Fitted pluggable connector; 4-pole; M12 plug, straight, A-coded; Spring

[www.wago.com/756-9202/040-000](http://www.wago.com/756-9202/040-000)



**Item no.:** 756-9205/040-000

Fitted pluggable connector; 4-pole; M12 plug, right angle; Spring

[www.wago.com/756-9205/040-000](http://www.wago.com/756-9205/040-000)



**Item no.:** 756-9711/050-000

Fitted pluggable connector; 5-pole, shielded; M12 socket, straight; IDC technology

[www.wago.com/756-9711/050-000](http://www.wago.com/756-9711/050-000)



**Item no.:** 756-9701/050-000

Fitted pluggable connector; 5-pole, shielded; M12 plug, straight; IDC technology

[www.wago.com/756-9701/050-000](http://www.wago.com/756-9701/050-000)

#### Configurable shielded connectors



**Item no.:** 756-9501/060-000

Fitted pluggable connector; 4-pole, shielded; M12 plug, straight, D-coded; Spring

[www.wago.com/756-9501/060-000](http://www.wago.com/756-9501/060-000)



**Item no.:** 756-9501/040-000

Accessories; M12 plug, right angle; 4-pole

[www.wago.com/756-9501/040-000](http://www.wago.com/756-9501/040-000)

#### Power cable



**Item no.:** 756-3501/050-075

Power cable; M12L socket; straight; 5-pole; Length: 7.5 m

[www.wago.com/756-3501/050-075](http://www.wago.com/756-3501/050-075)



**Item no.:** 756-3501/050-100

Power cable; M12L socket; straight; 5-pole; Length: 10 m

[www.wago.com/756-3501/050-100](http://www.wago.com/756-3501/050-100)



**Item no.:** 756-3501/050-150

Power cable; M12L socket; straight; 5-pole; Length: 15 m

[www.wago.com/756-3501/050-150](http://www.wago.com/756-3501/050-150)

Subject to changes. Please also observe the further product documentation!

WAGO GmbH & Co. KG

Hansastr. 27













32423 Minden

Phone: +49571 887-0 | Fax: +49571 887-169













Email: [info.de@wago.com](mailto:info.de@wago.com) | Web: [www.wago.com](http://www.wago.com)

Do you have any questions about our products?

We are always happy to take your call at +49 (571) 887-44222.











|   |   |  |
|---|---|--|
|     | <b>Item no.: 756-3501/050-050</b><br>Power cable; M12L socket; straight; 5-pole; Length: 5 m                        | <a href="http://www.wago.com/756-3501/050-050">www.wago.com/756-3501/050-050</a> |
|     | <b>Item no.: 756-3502/050-050</b><br>Power cable; M12L socket; angled; 5-pole; Length: 5 m                          | <a href="http://www.wago.com/756-3502/050-050">www.wago.com/756-3502/050-050</a> |
|     | <b>Item no.: 756-3502/050-150</b><br>Power cable; M12L socket; angled; 5-pole; Length: 15 m                         | <a href="http://www.wago.com/756-3502/050-150">www.wago.com/756-3502/050-150</a> |
|     | <b>Item no.: 756-3502/050-075</b><br>Power cable; M12L socket; angled; 5-pole; Length: 7.5 m                        | <a href="http://www.wago.com/756-3502/050-075">www.wago.com/756-3502/050-075</a> |
|     | <b>Item no.: 756-3502/050-100</b><br>Power cable; M12L socket; angled; 5-pole; Length: 10 m                         | <a href="http://www.wago.com/756-3502/050-100">www.wago.com/756-3502/050-100</a> |
|   | <b>Item no.: 756-3503/050-075</b><br>Power cable; M12L plug; straight; 5-pole; Length: 7.5 m                        | <a href="http://www.wago.com/756-3503/050-075">www.wago.com/756-3503/050-075</a> |
|  | <b>Item no.: 756-3503/050-150</b><br>Power cable; M12L plug; straight; 5-pole; Length: 15 m                         | <a href="http://www.wago.com/756-3503/050-150">www.wago.com/756-3503/050-150</a> |
|  | <b>Item no.: 756-3503/050-100</b><br>Power cable; M12L plug; straight; 5-pole; Length: 10 m                         | <a href="http://www.wago.com/756-3503/050-100">www.wago.com/756-3503/050-100</a> |
|   | <b>Item no.: 756-3505/050-003</b><br>Power cable; M12L socket; straight; M12L plug; straight; 5-pole; Length: 0.3 m | <a href="http://www.wago.com/756-3505/050-003">www.wago.com/756-3505/050-003</a> |
|   | <b>Item no.: 756-3505/050-005</b><br>Power cable; M12L socket; straight; M12L plug; straight; 5-pole; Length: 0.5 m | <a href="http://www.wago.com/756-3505/050-005">www.wago.com/756-3505/050-005</a> |
|   | <b>Item no.: 756-3505/050-020</b><br>Power cable; M12L socket; straight; M12L plug; straight; 5-pole; Length: 2 m   | <a href="http://www.wago.com/756-3505/050-020">www.wago.com/756-3505/050-020</a> |
|   | <b>Item no.: 756-3505/050-010</b><br>Power cable; M12L socket; straight; M12L plug; straight; 5-pole; Length: 1 m   | <a href="http://www.wago.com/756-3505/050-010">www.wago.com/756-3505/050-010</a> |

Subject to changes. Please also observe the further product documentation!

|  |   |  |
|--|---|--|
|    | <b>Item no.: 756-3505/050-050</b><br>Power cable; M12L socket; straight; M12L plug; straight; 5-pole; Length: 5 m   | <a href="http://www.wago.com/756-3505/050-050">www.wago.com/756-3505/050-050</a> |
|    | <b>Item no.: 756-3505/050-075</b><br>Power cable; M12L socket; straight; M12L plug; straight; 5-pole; Length: 7.5 m | <a href="http://www.wago.com/756-3505/050-075">www.wago.com/756-3505/050-075</a> |
|    | <b>Item no.: 756-3505/050-100</b><br>Power cable; M12L socket; straight; M12L plug; straight; 5-pole; Length: 10 m  | <a href="http://www.wago.com/756-3505/050-100">www.wago.com/756-3505/050-100</a> |
|    | <b>Item no.: 756-3506/050-100</b><br>Power cable; M12L socket; angled; M12L plug; angled; 5-pole; Length: 10 m      | <a href="http://www.wago.com/756-3506/050-100">www.wago.com/756-3506/050-100</a> |
|    | <b>Item no.: 756-3506/050-075</b><br>Power cable; M12L socket; angled; M12L plug; angled; 5-pole; Length: 7.5 m     | <a href="http://www.wago.com/756-3506/050-075">www.wago.com/756-3506/050-075</a> |
|    | <b>Item no.: 756-3506/050-150</b><br>Power cable; M12L socket; angled; M12L plug; angled; 5-pole; Length: 15 m      | <a href="http://www.wago.com/756-3506/050-150">www.wago.com/756-3506/050-150</a> |
|   | <b>Item no.: 756-3501/050-020</b><br>Power cable; M12L socket; straight; 5-pole; Length: 2 m                        | <a href="http://www.wago.com/756-3501/050-020">www.wago.com/756-3501/050-020</a> |
|  | <b>Item no.: 756-3502/050-020</b><br>Power cable; M12L socket; angled; 5-pole; Length: 2 m                          | <a href="http://www.wago.com/756-3502/050-020">www.wago.com/756-3502/050-020</a> |
|  | <b>Item no.: 756-3503/050-020</b><br>Power cable; M12L plug; straight; 5-pole; Length: 2 m                          | <a href="http://www.wago.com/756-3503/050-020">www.wago.com/756-3503/050-020</a> |
|  | <b>Item no.: 756-3503/050-050</b><br>Power cable; M12L plug; straight; 5-pole; Length: 5 m                          | <a href="http://www.wago.com/756-3503/050-050">www.wago.com/756-3503/050-050</a> |
|  | <b>Item no.: 756-3504/050-020</b><br>Power cable; M12L plug; angled; 5-pole; Length: 2 m                            | <a href="http://www.wago.com/756-3504/050-020">www.wago.com/756-3504/050-020</a> |
|  | <b>Item no.: 756-3504/050-050</b><br>Power cable; M12L plug; angled; 5-pole; Length: 5 m                            | <a href="http://www.wago.com/756-3504/050-050">www.wago.com/756-3504/050-050</a> |

Subject to changes. Please also observe the further product documentation!

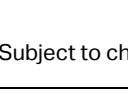

|   |   |  |
|---|---|--|
|    | <b>Item no.: 756-3504/050-075</b><br>Power cable; M12L plug; angled; 5-pole; Length: 7.5 m                                  | <a href="http://www.wago.com/756-3504/050-075">www.wago.com/756-3504/050-075</a> |
|    | <b>Item no.: 756-3504/050-100</b><br>Power cable; M12L plug; angled; 5-pole; Length: 10 m                                   | <a href="http://www.wago.com/756-3504/050-100">www.wago.com/756-3504/050-100</a> |
|    | <b>Item no.: 756-3504/050-150</b><br>Power cable; M12L plug; angled; 5-pole; Length: 15 m                                   | <a href="http://www.wago.com/756-3504/050-150">www.wago.com/756-3504/050-150</a> |
|     | <b>Item no.: 756-3505/050-150</b><br>Power cable; M12L socket; straight; M12L plug; straight; 5-pole; Length: 15 m          | <a href="http://www.wago.com/756-3505/050-150">www.wago.com/756-3505/050-150</a> |
|    | <b>Item no.: 756-3506/050-003</b><br>Power cable; M12L socket; angled; M12L plug; angled; 5-pole; Length: 0.3 m             | <a href="http://www.wago.com/756-3506/050-003">www.wago.com/756-3506/050-003</a> |
|   | <b>Item no.: 756-3506/050-005</b><br>Power cable; M12L socket; angled; M12L plug; angled; 5-pole; Length: 0.5 m             | <a href="http://www.wago.com/756-3506/050-005">www.wago.com/756-3506/050-005</a> |
|  | <b>Item no.: 756-3506/050-020</b><br>Power cable; M12L socket; angled; M12L plug; angled; 5-pole; Length: 2 m               | <a href="http://www.wago.com/756-3506/050-020">www.wago.com/756-3506/050-020</a> |
|  | <b>Item no.: 756-3506/050-010</b><br>Power cable; M12L socket; angled; M12L plug; angled; 5-pole; Length: 1 m               | <a href="http://www.wago.com/756-3506/050-010">www.wago.com/756-3506/050-010</a> |
|  | <b>Item no.: 756-3506/050-050</b><br>Power cable; M12L socket; angled; M12L plug; angled; 5-pole; Length: 5 m               | <a href="http://www.wago.com/756-3506/050-050">www.wago.com/756-3506/050-050</a> |
| Distribution connector  |   |  |
|   | <b>Item no.: 756-5513/040-010</b><br>Sensor/Actuator cable; 2xM8 socket; straight; M12A plug; straight; 4-pole; Length: 1 m | <a href="http://www.wago.com/756-5513/040-010">www.wago.com/756-5513/040-010</a> |
|   | <b>Item no.: 756-5513/040-020</b><br>Sensor/Actuator cable; 2xM8 socket; straight; M12A plug; straight; 4-pole; Length: 2 m | <a href="http://www.wago.com/756-5513/040-020">www.wago.com/756-5513/040-020</a> |
|   | <b>Item no.: 756-5514/040-010</b><br>Sensor/Actuator cable; 2xM8 socket; angled; M12A plug; straight; 4-pole; Length: 1 m   | <a href="http://www.wago.com/756-5514/040-010">www.wago.com/756-5514/040-010</a> |

Subject to changes. Please also observe the further product documentation!



**Item no.:** 756-5514/040-020  
Sensor/Actuator cable; 2xM8 socket; angled; M12A plug; straight; 4-pole; Length: 2 m

[www.wago.com/756-5514/040-020](http://www.wago.com/756-5514/040-020)



**Item no.:** 756-5516/040-010  
Sensor/Actuator cable; 2xM12 socket; straight; M12A plug; straight; 4-pole; Length: 1 m

[www.wago.com/756-5516/040-010](http://www.wago.com/756-5516/040-010)



**Item no.:** 756-5516/040-020  
Sensor/Actuator cable; 2xM12 socket; straight; M12A plug; straight; 4-pole; Length: 2 m

[www.wago.com/756-5516/040-020](http://www.wago.com/756-5516/040-020)



**Item no.:** 756-5517/040-010  
Sensor/Actuator cable; 2xM12 socket; angled; M12A plug; straight; 4-pole; Length: 1 m

[www.wago.com/756-5517/040-010](http://www.wago.com/756-5517/040-010)



**Item no.:** 756-5517/040-020  
Sensor/Actuator cable; 2xM12 socket; angled; M12A plug; straight; 4-pole; Length: 2 m

[www.wago.com/756-5517/040-020](http://www.wago.com/756-5517/040-020)



**Item no.:** 756-9301/050-000  
Accessories; 5-pole

[www.wago.com/756-9301/050-000](http://www.wago.com/756-9301/050-000)



**Item no.:** 756-9301/040-000  
Accessories; 4-pole

[www.wago.com/756-9301/040-000](http://www.wago.com/756-9301/040-000)

#### ETHERNET/PROFINET cable



**Item no.:** 756-1202/060-200  
ETHERNET cable; M12D plug; angled; 4-pole; Length: 20 m

[www.wago.com/756-1202/060-200](http://www.wago.com/756-1202/060-200)



**Item no.:** 756-1201/060-100  
ETHERNET cable; M12D plug; straight; 4-pole; Length: 10 m

[www.wago.com/756-1201/060-100](http://www.wago.com/756-1201/060-100)



**Item no.:** 756-1201/060-050  
ETHERNET cable; M12D plug; straight; 4-pole; Length: 5 m

[www.wago.com/756-1201/060-050](http://www.wago.com/756-1201/060-050)



**Item no.:** 756-1203/060-050  
ETHERNET cable; M12D plug; straight; M12D plug; straight; 4-pole; Length: 5 m













[www.wago.com/756-1203/060-050](http://www.wago.com/756-1203/060-050)



**Item no.:** 756-1203/060-020  
ETHERNET cable; M12D plug; straight; M12D plug; straight; 4-pole; Length: 2 m

[www.wago.com/756-1203/060-020](http://www.wago.com/756-1203/060-020)

Subject to changes. Please also observe the further product documentation!

|   |   |  |
|---|---|--|
|    | <b>Item no.: 756-1202/060-020</b><br>ETHERNET cable; M12D plug; angled; 4-pole; Length: 2 m                         | <a href="http://www.wago.com/756-1202/060-020">www.wago.com/756-1202/060-020</a> |
|     | <b>Item no.: 756-1201/060-200</b><br>ETHERNET cable; M12D plug; straight; 4-pole; Length: 20 m                      | <a href="http://www.wago.com/756-1201/060-200">www.wago.com/756-1201/060-200</a> |
|     | <b>Item no.: 756-1204/060-050</b><br>ETHERNET cable; M12D plug; angled; M12D plug; angled; 4-pole; Length: 5 m      | <a href="http://www.wago.com/756-1204/060-050">www.wago.com/756-1204/060-050</a> |
|     | <b>Item no.: 756-1204/060-100</b><br>ETHERNET cable; M12D plug; angled; M12D plug; angled; 4-pole; Length: 10 m     | <a href="http://www.wago.com/756-1204/060-100">www.wago.com/756-1204/060-100</a> |
|     | <b>Item no.: 756-1204/060-200</b><br>ETHERNET cable; M12D plug; angled; M12D plug; angled; 4-pole; Length: 20 m     | <a href="http://www.wago.com/756-1204/060-200">www.wago.com/756-1204/060-200</a> |
|     | <b>Item no.: 756-1203/060-200</b><br>ETHERNET cable; M12D plug; straight; M12D plug; straight; 4-pole; Length: 20 m | <a href="http://www.wago.com/756-1203/060-200">www.wago.com/756-1203/060-200</a> |
|    | <b>Item no.: 756-1203/060-100</b><br>ETHERNET cable; M12D plug; straight; M12D plug; straight; 4-pole; Length: 10 m | <a href="http://www.wago.com/756-1203/060-100">www.wago.com/756-1203/060-100</a> |
|   | <b>Item no.: 756-1204/060-010</b><br>ETHERNET cable; M12D plug; angled; M12D plug; angled; 4-pole; Length: 1 m      | <a href="http://www.wago.com/756-1204/060-010">www.wago.com/756-1204/060-010</a> |
|   | <b>Item no.: 756-1204/060-030</b><br>ETHERNET cable; M12D plug; angled; M12D plug; angled; 4-pole; Length: 3 m      | <a href="http://www.wago.com/756-1204/060-030">www.wago.com/756-1204/060-030</a> |
|   | <b>Item no.: 756-1204/060-020</b><br>ETHERNET cable; M12D plug; angled; M12D plug; angled; 4-pole; Length: 2 m      | <a href="http://www.wago.com/756-1204/060-020">www.wago.com/756-1204/060-020</a> |
|  | <b>Item no.: 756-1202/060-050</b><br>ETHERNET cable; M12D plug; angled; 4-pole; Length: 5 m                         | <a href="http://www.wago.com/756-1202/060-050">www.wago.com/756-1202/060-050</a> |
|  | <b>Item no.: 756-1202/060-100</b><br>ETHERNET cable; M12D plug; angled; 4-pole; Length: 10 m                        | <a href="http://www.wago.com/756-1202/060-100">www.wago.com/756-1202/060-100</a> |

Subject to changes. Please also observe the further product documentation!



Item no.: 756-1201/060-020  
ETHERNET cable; M12D plug; straight; 4-pole; Length: 2 m

## Downloads

### Documentation

#### Manual

|   |                        |               |          |
|---|------------------------|---------------|----------|
| Product Manual 8-Port-IO Link Master Class A; EtherCAT; 24 VDC / 2.0 A;<br>8xM12 Connection; WideLine | V 2.0.0<br>2022 Jul 19 | pdf<br>9.1 MB | Download |
|---|------------------------|---------------|----------|

#### Instruction Leaflet

|                                 |             |               |          |
|---------------------------------|-------------|---------------|----------|
| I/O System Field package insert | 2021 Dec 15 | pdf<br>1.1 MB | Download |
|---------------------------------|-------------|---------------|----------|

#### System Description

|  |  |               |          |
|--|--|---------------|----------|
| WAGO I/O System Field; General Product Information |  | pdf<br>1.0 MB | Download |
|--|--|---------------|----------|

## Application Notes

### Application Note e!COCKPIT

|   |                      |                |          |
|---|----------------------|----------------|----------|
| e!COCKPIT Application Note EtherCAT IO-Field (a2022003)<br>WAGO EtherCAT Master, EoE access with IO-Field devices | 1.0.0<br>2023 Mar 23 | pptx<br>2.2 MB | Download |
|---|----------------------|----------------|----------|

## Engineering-Software

### WAGO IO-Link Configurator

|                           |                            |                |          |
|---------------------------|----------------------------|----------------|----------|
| WAGO IO-Link Configurator | V5.1.1-6618<br>2022 Feb 16 | ZIP<br>91.8 MB | Download |
|---------------------------|----------------------------|----------------|----------|

WAGO IO-Link Configurator allows configuration, parameterization, operation and monitoring of WAGO IO-Link Masters in the WAGO I/O System 750 and WAGO I/O System Field, and especially of the WAGO IO-Link devices connected to them.

Additionally, WAGO IO-Link Configurator can be used for complete configuration and operation of all IO-Link devices of third-party manufacturers, as long as they comply with the IO-Link specification. A product's process data can be visualized graphically and stored in trend curves. Up to eight elements can be selected for visualization, and the data can be recorded for up to 24 hours.

Device description files for the IO-Link Masters (IOLM) or IO-Link Devices (IODD) can be used to integrate new devices into the tool at any time. Convenient access to the IO-Link user organization's IODDfinder is available for the IODDs. This allows automated, selective download of IODDs when integrating new IO-Link devices. An integrated IODD viewer allows detailed insight into the IODD device description.

Subject to changes. Please also observe the further product documentation!



WAGO IO-Link Configurator can be used either as a standalone program or integrated into engineering systems with a TCI interface and *WAGO-I/O-CHECK*.

IO-Link Configurator can also be used to integrate the IO-Link Master (750-657) of the WAGO I/O System 750 Series and to access all the configurator's functions. This is made possible by the WAGO I/O System 750 IO-Link Adapter, which can be retrofitted. The WAGO I/O System 750 IO-Link Adapter requires the current version of WAGO IO-Link Configurator and a current version of *WAGO-I/O-CHECK*.

In addition, the download file contains the device descriptions for the respective fieldbus systems of the WAGO I/O System Field modules. These are pre-installed in the Configurator setup.

The WAGO IO-Link Configurator license is assigned to the specific PC on which it is installed (a workstation license).

Register now and test our engineering software for 30 days at no cost.

---

## Runtime Software

### Firmware

|                                 |            |        |          |
|---------------------------------|------------|--------|----------|
| 0765-x2xx, EtherCat IO-Field    | V 04       | zip    | Download |
| WAGO_FW0765-x2xx_V01010021_IX04 | 2023 Feb 2 | 1.6 MB |          |

---

## CAD/CAE-Data

### CAD data

|                               |     |          |
|-------------------------------|-----|----------|
| 2D/3D Models 765-4201/100-000 | URL | Download |
|-------------------------------|-----|----------|

### CAE data

|                                    |     |          |
|------------------------------------|-----|----------|
| EPLAN Data Portal 765-4201/100-000 | URL | Download |
|------------------------------------|-----|----------|

---

## Device Files

### Device Description File

|  |           |                |          |
|--|-----------|----------------|----------|
| Gerätebeschreibungdateien 765-42xx, 765-12xx, EtherCAT | V1_1_0_17 | zip<br>73.6 kB | Download |
|--|-----------|----------------|----------|

---

## Environmental Product Compliance

### Compliance Search

|  |     |          |
|--|-----|----------|
| Environmental Product Compliance 765-4201/100-000<br>8-Port IO-Link Master Class A; EtherCAT; DC 24 V / 2.0 A; 8xM12 connection;<br>WideLine | URL | Download |
|--|-----|----------|

Subject to changes. Please also observe the further product documentation!



## Installation Notes

## Product family

**WAGO I/O System Field**

Show all products from the family

Subject to changes. Please also observe the further product documentation!

---

WAGO GmbH & Co. KG

Hansastr. 27

32423 Minden

Phone: +49571 887-0 | Fax: +49571 887-169

Email: [info.de@wago.com](mailto:info.de@wago.com) | Web: [www.wago.com](http://www.wago.com)

Do you have any questions about our products?

We are always happy to take your call at +49 (571) 887-44222.