

E3D20065D

Silicon Carbide Schottky Diode E-Series Automotive

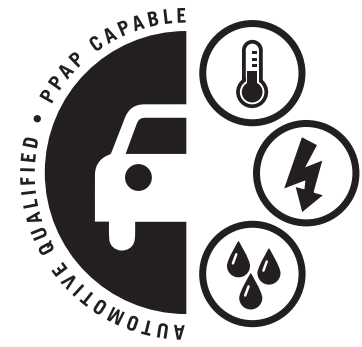

Features

- 650-Volt Schottky Rectifier
- Zero Reverse Recovery Current
- Zero Forward Recovery Voltage
- High-Frequency Operation
- Temperature-Independent Switching Behavior
- Extremely Fast Switching
- Positive Temperature Coefficient on V_F

Benefits

- Higher System Level Efficiency
- Increase System Power Density
- Reduction of Heat Sink Requirements
- Parallel Devices Without Thermal Runaway

Applications

- Automotive and Traction Power Conversion
- Battery Charging Systems
- Boost Diode in PFC or DC/DC Stages
- Free Wheeling Diodes in Inverter Stages
- AC/DC Converters
- PV Inverters

Package

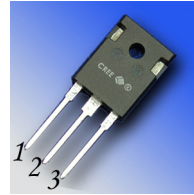

TO-247-3

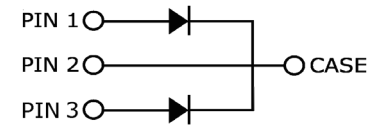

Part Number	Package	Marking
E3D20065D	TO-247-3	E3D20065D

8.0 Maximum Ratings ($T_c = 25^\circ\text{C}$ unless otherwise specified)

Symbol	Parameter	Value	Unit	Test Conditions	Note
V_{RRM}	Repetitive Peak Reverse Voltage	650	V		
V_R	DC Peak Reverse Voltage	650	V		
I_F	Continuous Forward Current	28*/56** 13*/26** 10*/20**	A	$T_c=25^\circ\text{C}$ $T_c=135^\circ\text{C}$ $T_c=150^\circ\text{C}$	Fig. 3
P_{tot}	Power Dissipation	122* 53*	W	$T_c=25^\circ\text{C}$ $T_c=110^\circ\text{C}$	Fig. 4
I_{FRM}	Repetitive Peak Forward Surge Current	37* 22*	A	$T_c=25^\circ\text{C}$, $t_p=10$ ms, Half Sine Pulse $T_c=110^\circ\text{C}$, $t_p=10$ ms, Half Sine Pulse	
dV/dt	Diode dV/dt ruggedness	200	V/ns	$V_R=0-650\text{V}$	
T_J, T_{stg}	Operating Junction and Storage Temperature	-55 to +175	$^\circ\text{C}$		
	TO-247 Mounting Torque	1 8.8	Nm lbf-in	M3 Screw 6-32 Screw	

* Per Leg, ** Per Device

Electrical Characteristics

Symbol	Parameter	Typ.	Max.	Unit	Test Conditions	Note
V_F	Forward Voltage	1.5* 2.0*	1.8* 2.4*	V	$I_F = 10\text{ A}$ $T_J = 25^\circ\text{C}$ $I_F = 10\text{ A}$ $T_J = 175^\circ\text{C}$	Fig. 1
I_R	Reverse Current	12* 24*	60* 220*	μA	$V_R = 650\text{ V}$ $T_J = 25^\circ\text{C}$ $V_R = 650\text{ V}$ $T_J = 175^\circ\text{C}$	Fig. 2
Q_C	Total Capacitive Charge	28*		nC	$V_R = 400\text{ V}$, $I_F = 10\text{ A}$ $T_J = 25^\circ\text{C}$	Fig. 5
C	Total Capacitance	459* 55* 49*		pF	$V_R = 0\text{ V}$, $T_J = 25^\circ\text{C}$, $f = 1\text{ MHz}$ $V_R = 200\text{ V}$, $T_J = 25^\circ\text{C}$, $f = 1\text{ MHz}$ $V_R = 400\text{ V}$, $T_J = 25^\circ\text{C}$, $f = 1\text{ MHz}$	Fig. 6
E_C	Capacitance Stored Energy	4.5*		μJ	$V_R = 400\text{ V}$	Fig. 7

Note: This is a majority carrier diode, so there is no reverse recovery charge.

Thermal Characteristics

Symbol	Parameter	Typ.	Unit	Note
$R_{\theta JC}$	Thermal Resistance from Junction to Case	1.23* 0.62**	$^\circ\text{C}/\text{W}$	Fig. 8

* Per Leg, ** Per Device

Typical Performance (Per Leg)

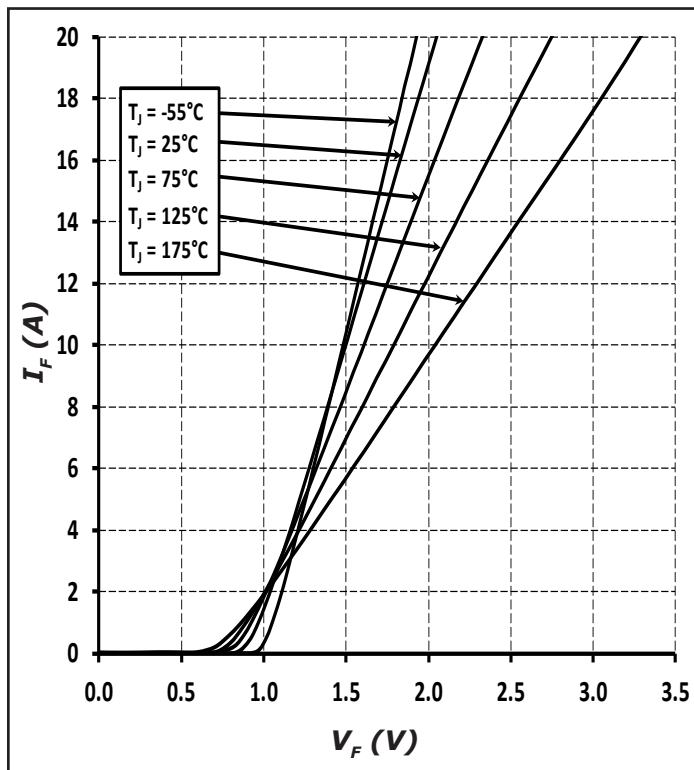

Figure 1. Forward Characteristics

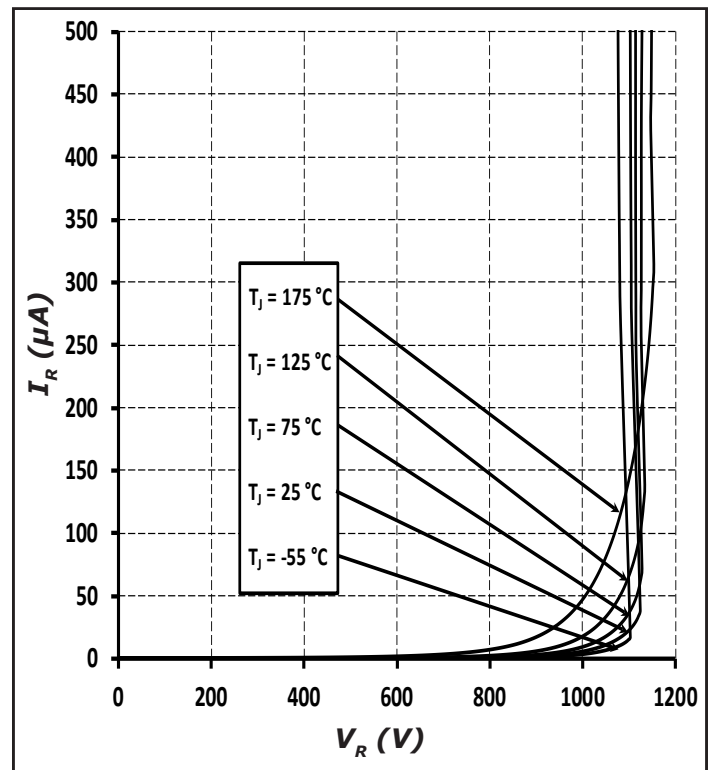

Figure 2. Reverse Characteristics

Typical Performance (Per Leg)

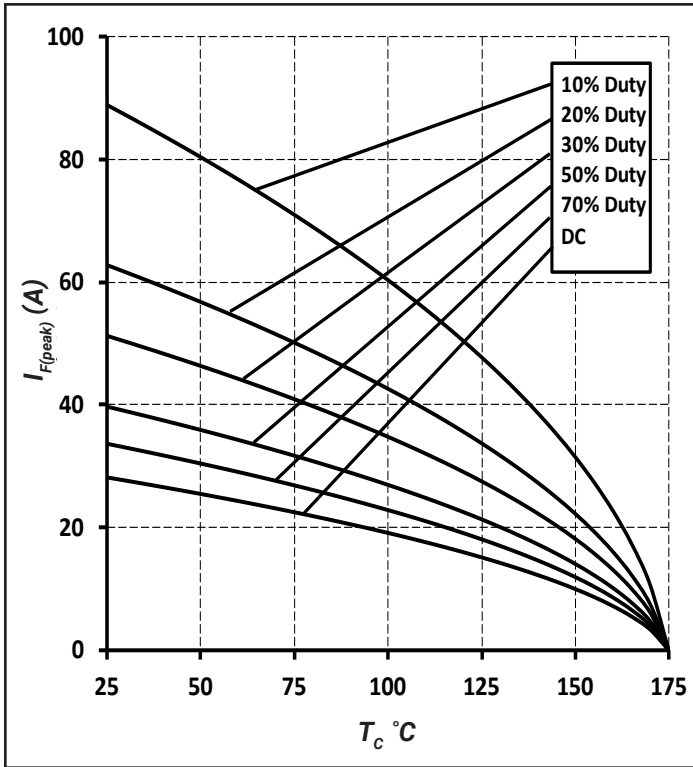

Figure 3. Current Derating

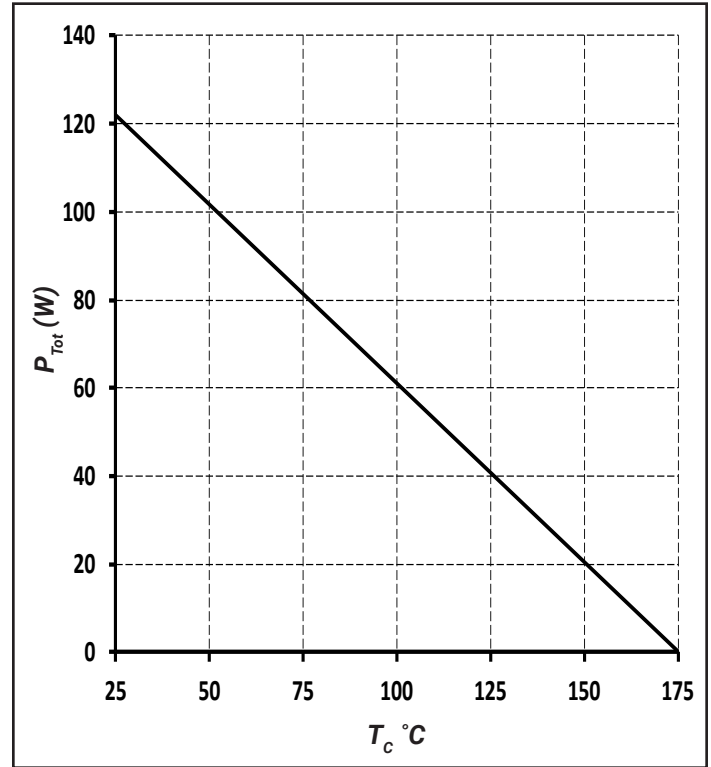

Figure 4. Power Derating

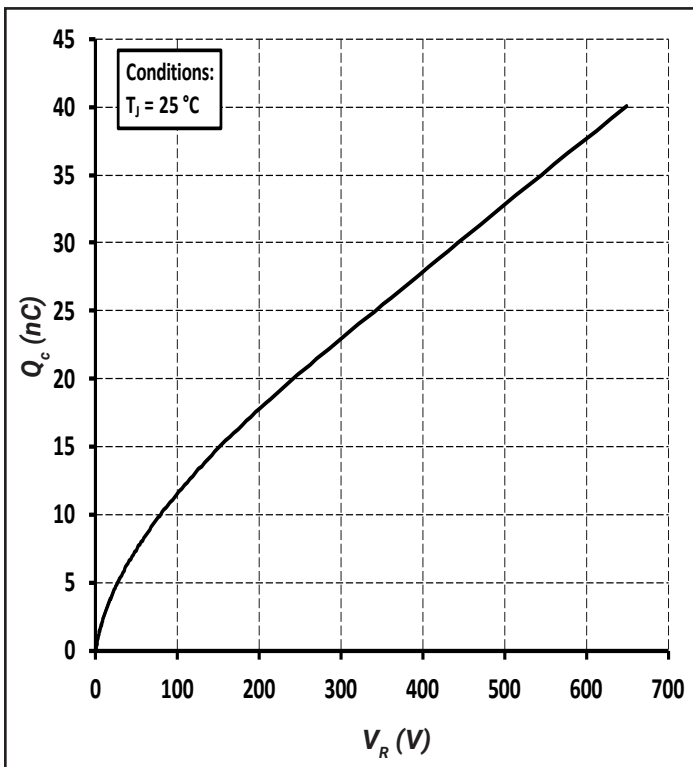

Figure 5. Recovery Charge vs. Reverse Voltage

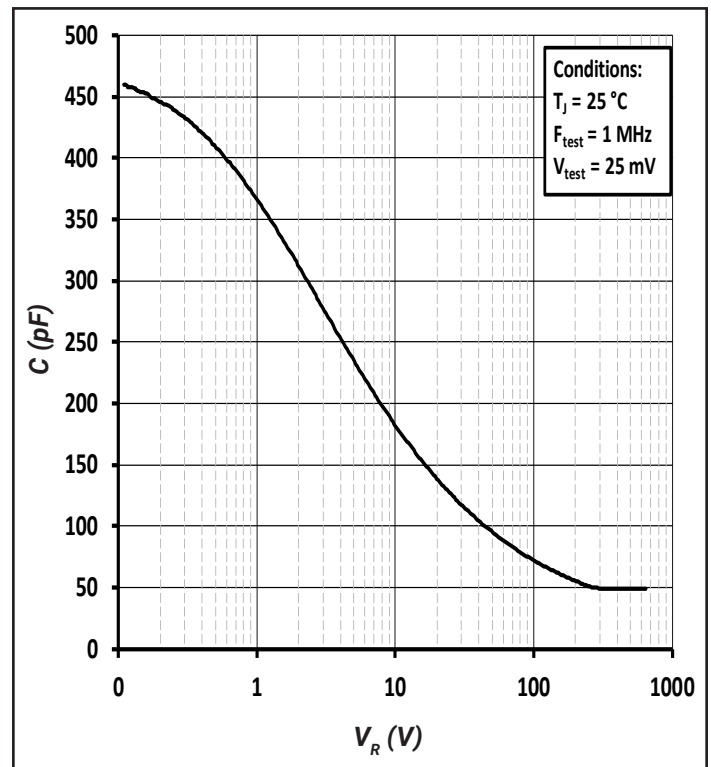

Figure 6. Capacitance vs. Reverse Voltage

Typical Performance (Per Leg)

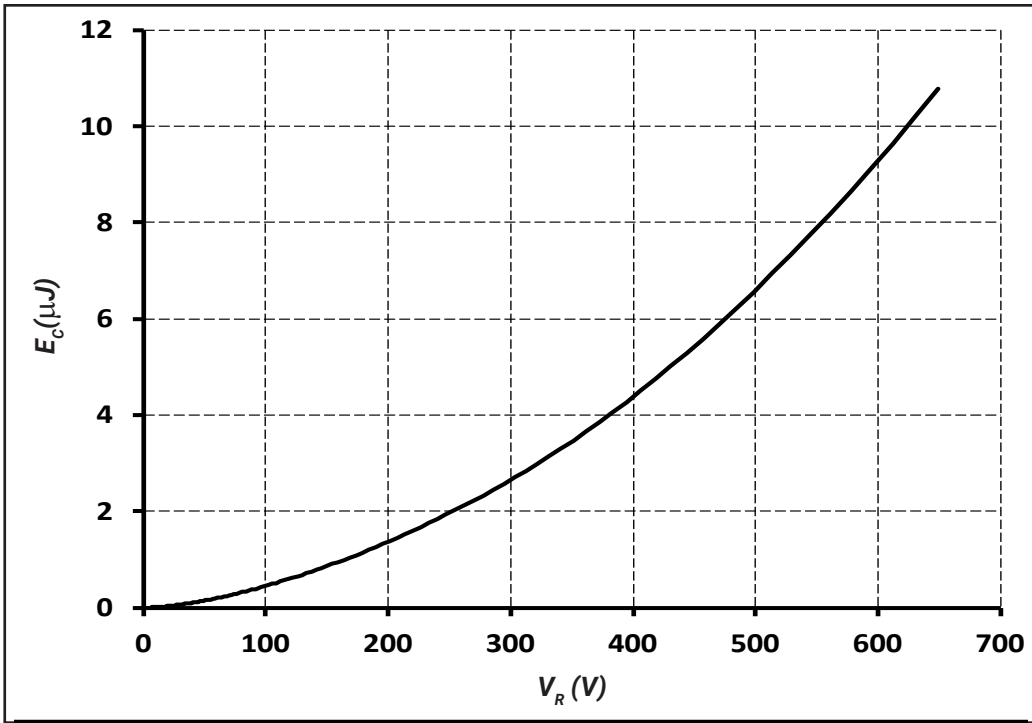

Figure 7. Typical Capacitance Stored Energy

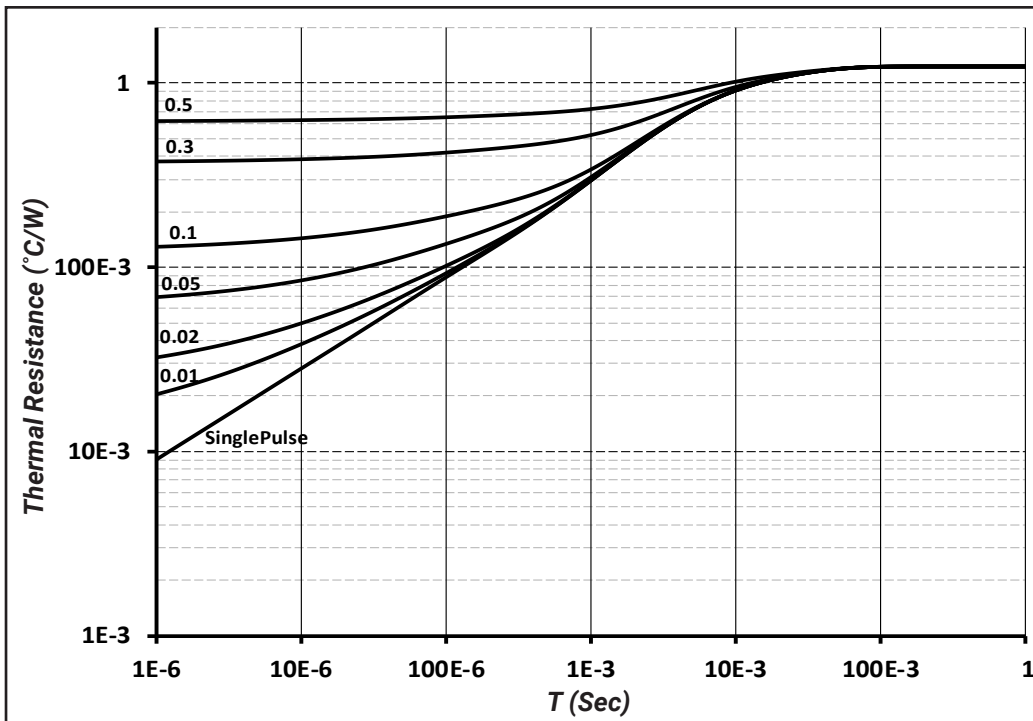
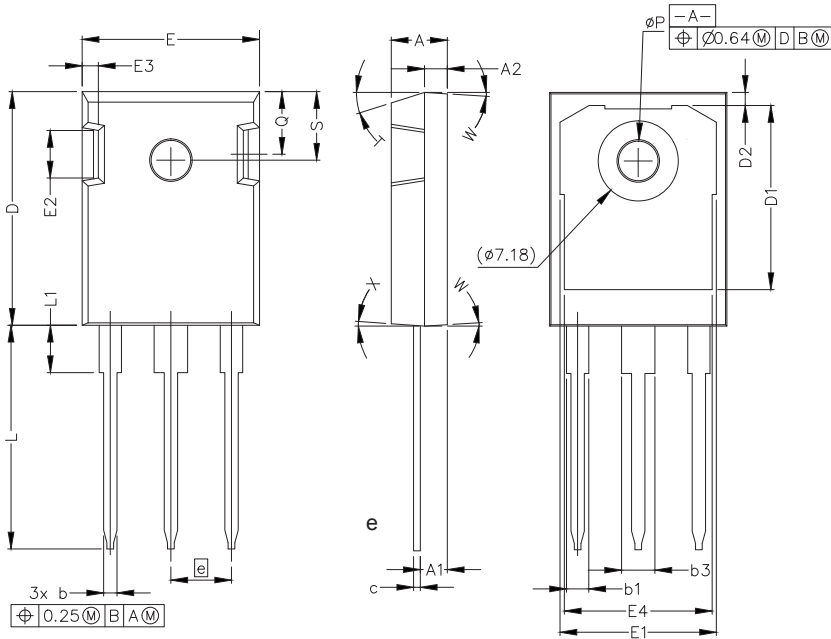

Figure 8. Transient Thermal Impedance

Package Dimensions

Package TO-247-3



POS	Inches		Millimeters	
	Min	Max	Min	Max
A	.190	.205	4.83	5.21
A1	.090	.100	2.29	2.54
A2	.075	.085	1.91	2.16
b	.042	.052	1.07	1.33
b1	.075	.095	1.91	2.41
b3	.113	.133	2.87	3.38
c	.022	.027	0.55	0.68
D	.819	.831	20.80	21.10
D1	.640	.695	16.25	17.65
D2	.037	.049	0.95	1.25
E	.620	.635	15.75	16.13
E1	.516	.557	13.10	14.15
E2	.145	.201	3.68	5.10
E3	.039	.075	1.00	1.90
E4	.487	.529	12.38	13.43
e	.214 BSC		5.44 BSC	
L	.780	.800	19.81	20.32
L1	.161	.173	4.10	4.40
N	3			
ØP	.138	.144	3.51	3.65
Q	.216	.236	5.49	6.00
S	.238	.248	6.04	6.30
T	17.5° REF			
W	3.5° REF			
X	4° REF			

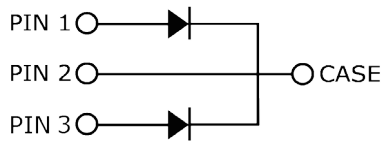

Recommended Solder Pad Layout

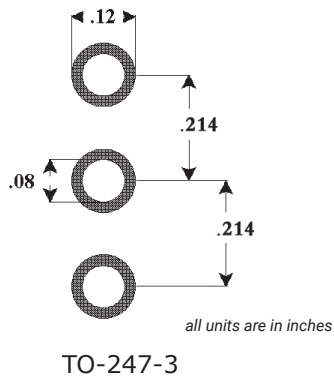

Part Number	Package	Marking
E3D20065D	TO-247-3	E3D20065D

Note: Recommended soldering profiles can be found in the applications note here: http://www.wolfspeed.com/power_app_notes/soldering



Notes

- **RoHS Compliance**

The levels of RoHS restricted materials in this product are below the maximum concentration values (also referred to as the threshold limits) permitted for such substances, or are used in an exempted application, in accordance with EU Directive 2011/65/EC (RoHS2), as implemented January 2, 2013. RoHS Declarations for this product can be obtained from your Wolfspeed representative or from the Product Ecology section of our website at <http://www.wolfspeed.com/power/tools-and-support/product-ecology>.

- **REACH Compliance**

REACH substances of high concern (SVHCs) information is available for this product. Since the European Chemical Agency (ECHA) has published notice of their intent to frequently revise the SVHC listing for the foreseeable future, please contact a Cree representative to insure you get the most up-to-date REACH SVHC Declaration. REACH banned substance information (REACH Article 67) is also available upon request.

- This product has not been designed or tested for use in, and is not intended for use in, applications implanted into the human body nor in applications in which failure of the product could lead to death, personal injury or property damage, including but not limited to equipment used in the operation of nuclear facilities, life-support machines, cardiac defibrillators or similar emergency medical equipment, aircraft navigation or communication or control systems, or air traffic control systems.

Related Links

- Wolfspeed E-Series Family: <http://wolfspeed.com/E-Series>
- Wolfspeed SiC Schottky diode portfolio: <http://www.wolfspeed.com/Power/Products#SiCSchottkyDiodes>
- Schottky diode Spice models: <http://www.wolfspeed.com/power/tools-and-support/DIODE-model-request2>
- SiC MOSFET and diode reference designs: <http://go.pardot.com/l/101562/2015-07-31/349i>