

## T111D196K035AS

Aliases (T111D196K035AS{Bulk})

T111, Tantalum, MnO2 Tantalum, Commercial Grade, 19 uF, 10%, 35 VDC

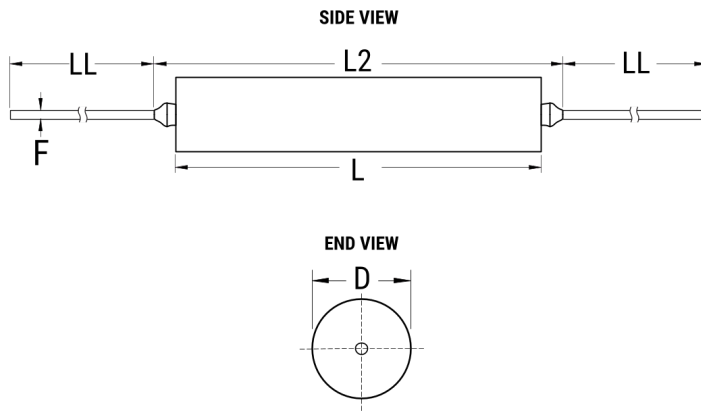

Click [here](#) for the 3D model.

### Dimensions

D	9.55mm +0.25/-0.38mm
L	39.37mm +/-0.79mm
L2	43.82mm
LL	38.1mm +/-6.35mm
F	0.64mm +/-0.05mm

### Packaging Specifications

Packaging	Bulk, Bag
Packaging Quantity	10

### General Information

Series	T111
Dielectric	MnO2 Tantalum
Style	Axial Hermetic
Description	Axial, Solid Tantalum, Hermetically Sealed, Military (Non-ER), Non-Polar
Features	BiPolar, Low Leakage, Low DF
RoHS	No
Prop 65	<b>⚠ WARNING:</b> Cancer and reproductive harm - <a href="http://www.p65warnings.ca.gov">http://www.p65warnings.ca.gov</a> .
SCIP Number	be146961-2c72-4b45-804a-c62bf7a8b23e
Termination	Lead (SnPb)
Lead	Wire Leads
AEC-Q200	No
Construction	Hermetic
Notes	Dimensions Include Insulation Sleeve.

### Specifications

Capacitance	19 uF
Capacitance Tolerance	10%
Voltage DC	35 VDC (85C), 28 VDC (125C Surge), 23 VDC (125C Reverse)
Temperature Range	-55/+125°C
Rated Temperature	85°C
Dissipation Factor	4%
Leakage Current	6 uA (25°C)