

8-Channel, Programmable T/R Switch for Ultrasound

Check for Samples: [TX810](#)

FEATURES

- Compact T/R Switch for Ultrasound
- Flexible Programmability
 - 8 Bias Current Settings
 - 8 Power/Performance Combinations
 - Easy Power-Up/Down control
- Fast Wake Up Time
- Dual Supply Operation
- Optimized Insertion Loss

APPLICATIONS

- Medical Ultrasound
- Industrial Ultrasound

DESCRIPTION

The TX810 provides an integrated solution for a wide range of ultrasound applications. It is an 8 channel, current programmable, transmit/receive switch in a small 6mm x 6mm package.

The internal diodes limit the output voltage when high voltage transmitter signals are applied to the input. While the insertion loss of TX810 is minimized during receive mode.

Unlike conventional T/R switches, the TX810 contains a 3-bit interface used to program bias current from 7mA to 0mA for different performance and power requirements. When the TX810 bias current is set as 0mA (i.e., high-impedance mode), the device is configured as power-down mode. In the high-impedance mode, TX810 does not add additional load to high-voltage transmitters. In addition, the device can wake up from power-down mode in less than 1 μ s. With these advanced programmability features, significant power saving can be achieved in systems.

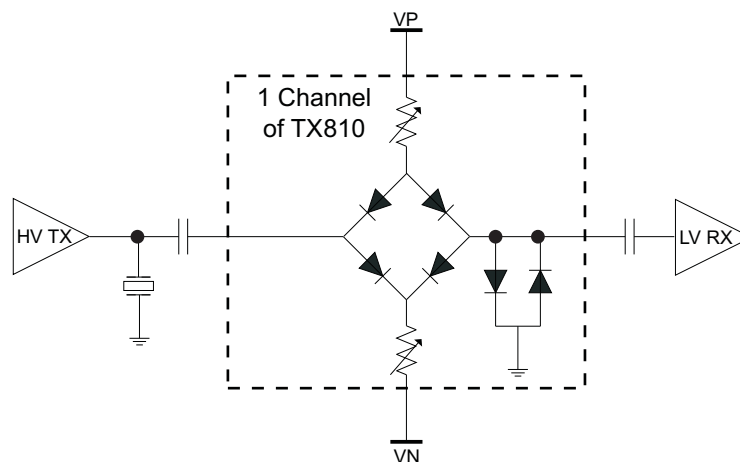

Figure 1. Block Diagram of TX810



Please be aware that an important notice concerning availability, standard warranty, and use in critical applications of Texas Instruments semiconductor products and disclaimers thereto appears at the end of this data sheet.

PowerPAD is a trademark of Texas Instruments.



These devices have limited built-in ESD protection. The leads should be shorted together or the device placed in conductive foam during storage or handling to prevent electrostatic damage to the MOS gates.

ORDERING INFORMATION⁽¹⁾

PACKAGED DEVICES	PACKAGE TYPE	TRANSPORT MEDIA, QUANTITY	OPERATING TEMPERATURE RANGE
TX810IRHHT	S-PVQFN-N36	Tape and Reel, 250	0~70°C
TX810IRHHR		Tape and Reel, 2500	

- (1) For the most current package and ordering information, see the Package Option Addendum at the end of this document, or see the TI website at www.ti.com.

ABSOLUTE MAXIMUM RATINGS⁽¹⁾

over operating free-air temperature range (unless otherwise noted)

	VALUE	UNIT
Supply Voltage, VD	-0.3 ~ +6	V
Supply Voltage, VP	-0.3 ~ +6	V
Supply Voltage, VN	-6 ~ +0.3	V
Supply Voltage, VB	-0.3 ~ +6	V
Input AC voltage, INn	±100	V
Input at Vsub	-6 ~ +0.3	V
Output current, IO	15	mA
Maximum junction temperature, continuous operation, long term reliability ⁽²⁾ TJ	125°C	
Storage temperature range, Tstg	-55°C to 150°C	
ESD ratings	HBM	500
	CDM	750
	MM	200

- (1) Stresses above those listed under absolute maximum ratings may cause permanent damage to the device. These are stress ratings only and functional operation of the device at these or any other conditions beyond those indicated under "recommended operating conditions" is not implied. Exposure to absolute maximum rated conditions for extended periods may degrade device reliability.
- (2) The absolute maximum junction temperature for continuous operation is limited by the package constraints. Operation above this temperature may result in reduced reliability and/or lifetime of the device.

THERMAL INFORMATION

	THERMAL METRIC ⁽¹⁾ (OLFM Airflow Assumed)	TX810	UNITS
		RHH	
		36 PINS	
θ_{JA}	Junction-to-ambient thermal resistance ⁽²⁾	29.7	°C/W
$\theta_{JC(top)}$	Junction-to-case(top) thermal resistance ⁽³⁾	27	
θ_{JB}	Junction-to-board thermal resistance ⁽⁴⁾	7.2	
ψ_{JT}	Junction-to-top characterization parameter ⁽⁵⁾	0.1	
ψ_{JB}	Junction-to-board characterization parameter ⁽⁶⁾	7.2	

- (1) For more information about traditional and new thermal metrics, see the *IC Package Thermal Metrics* application report, [SPRA953](#).
- (2) The junction-to-ambient thermal resistance under natural convection is obtained in a simulation on a JEDEC-standard, High-K board, as specified in JESD51-7, in an environment described in JESD51-2a.
- (3) The junction-to-case(top) thermal resistance is obtained by simulating a cold plate test on the package top. No specific JEDEC-standard test exists, but a close description can be found in the ANSI SEMI standard G30-88.
- (4) The junction-to-board thermal resistance is obtained by simulating in an environment with a ring cold plate fixture to control the PCB temperature, as described in JESD51-8.
- (5) The junction-to-top characterization parameter, ψ_{JT} , estimates the junction temperature of a device in a real system and is extracted from the simulation data for obtaining θ_{JA} , using a procedure described in JESD51-2a (sections 6 and 7).
- (6) The junction-to-board characterization parameter, ψ_{JB} , estimates the junction temperature of a device in a real system and is extracted from the simulation data for obtaining θ_{JA} , using a procedure described in JESD51-2a (sections 6 and 7).

DEVICE INFORMATION

PIN FUNCTIONS

PIN		DESCRIPTION
NUMBER	NAME	
1, 3, 7, 9, 10, 12, 34, 36	INn	Inputs for Channel n
16, 18, 19, 21, 25, 27, 28, 30	OUTn	Outputs for Channel n
33	VD	Logic Supply Voltage; +2.5 V to +5 V; bypass to ground with 0.1 μ F and 10 μ F capacitors
31	VP	Positive Supply Voltage; +5 V; bypass to ground with 0.1 μ F and 10 μ F capacitors
15	VN	Negative Supply Voltage; –5 V; bypass to ground with 0.1 μ F and 10 μ F capacitors
13	VB	Bias voltage; connect to 0 V (GND) for \pm 5 V operation
2, 8, 11, 14, 17, 20, 26, 29, 32, 35	GND	Ground
24	B1	Bit 1; Current program bit
23	B2	Bit 2; Current program bit
22	B3	Bit 3; Current program bit
4, 5, 6	NC	No internal connection.
0	Vsub	PowerPAD™ of the package. –5 V to 0 V for \pm 5 V operation. The thermal pad is needed for thermal dissipation.

**PQFN (RHH) Package
6 × 6mm, 0.5mm Pitch
(Top View)**

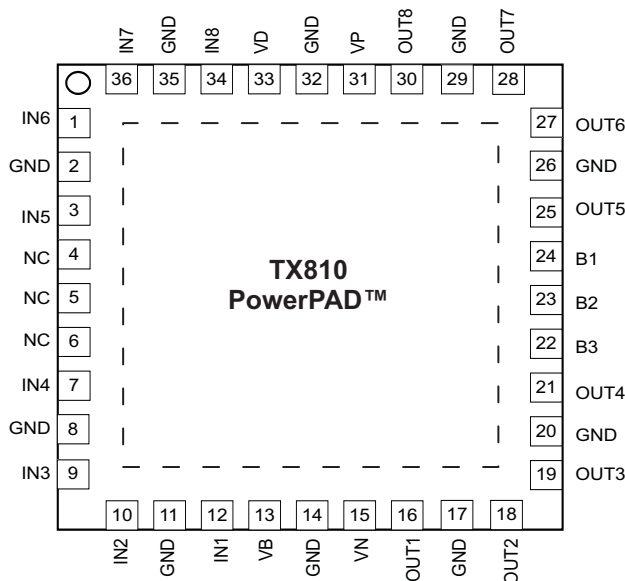

ELECTRICAL CHARACTERISTICS

All Specifications at $T_A = 25^\circ\text{C}$, $V_P = 5\text{V}$, $V_N = -5\text{V}$, $V_B = 0\text{V}$, $V_{\text{sub}} = -5\text{V}$, $R_{\text{LOAD}} = 400\Omega$; $f = 5\text{MHz}$, $B3B2B1 = 111$, $V_{\text{IN}} = 0.25V_{\text{PP}}$, unless otherwise noted. Test Level: A: Final tester limits; B: bench evaluation/simulation; C: Simulation

PARAMETER	TEST CONDITIONS	MIN	TYP	MAX	UNIT	Test Level
DC POWER SPECIFICATIONS						
Positive Supply V_P			5		V	B
Negative Supply V_N			-5			
Quiescent current, V_P , V_N	No Signal			50	μA	A
Substrate Voltage, V_{SUB}	PowerPAD™		V_N	0	V	B
Digital Supply, V_D		2.5	5		V	B
Quiescent current, V_D	No Signal			50	μA	A
Bias current, V_P , V_N path	B3B2B1 = 001	1.25	1	0.75	mA/CH	A
Bias current, V_P , V_N path	B3B2B1 = 111	5.95	7	8.05	mA/CH	A
Leakage Current	Any output; B3B2B1 = 000; No Input			0.5	μA	A
LOGIC INPUTS						
Logic High Input Voltage; V_{IH}		2		V_D	V	A
Logic High Input Current; I_{IH}				20	μA	A
Logic Low Input Voltage; V_{IL}		0		0.4	V	A
Logic Low Input Current; I_{IL} Input				20	μA	A
Capacitance, C_{IN}			5		pF	C
POWER DISSIPATION						
Power-Down Dissipation	B3B2B1 = 000; no signal			200	μW	A
Total Power Dissipation	B3B2B1 = 001; no signal		80	92	mW	A
	B3B2B1 = 111; no signal		560	644	mW	A
AC SPECIFICATIONS						
Input Amplitude, V_{IN}	1 μs positive and negative pulse applied separately at PRF = 10 kHz	-90		90	V	A
	CW mode (continuous wave)	-10		10	V	B
Insertion loss, I_L	B3B2B1 = 111		-0.9	-1.8	dB	A
	B3B2B1 = 100		-1.1	-1.8	dB	A
	B3B2B1 = 001		-1.3	-2	dB	A
	B3B2B1 = 111, $R_{\text{LOAD}} = 50\Omega$		-4.1		dB	B
	B3B2B1 = 001, $R_{\text{LOAD}} = 50\Omega$		-7		dB	B
Channel to channel I_L matching	B3B2B1 = 111		0.06		dB	B
Insertion Loss, I_L	B3B2B1 = 111, at 20MHz		-0.9		dB	B
Equivalent Resistance, R_{ON}	B3B2B1 = 111, $R_{\text{LOAD}} = 50\Omega$		30		Ω	B
	B3B2B1 = 001, $R_{\text{LOAD}} = 50\Omega$		62		Ω	B
	B3B2B1 = 111		44		Ω	B
	B3B2B1 = 001		67		Ω	B
-3dB Bandwidth, BW	B3B2B1 = 111		140		MHz	B
	B3B2B1 = 100		115		MHz	B
	B3B2B1 = 001		65		MHz	B
2nd Harmonic Distortion, HD2, 5MHz	B3B2B1 = 111, $V_{\text{IN}} = 0.5V_{\text{PP}}$ 5MHz		-74		dBc	B
	B3B2B1 = 100, $V_{\text{IN}} = 0.5V_{\text{PP}}$ 5MHz		-74		dBc	B
	B3B2B1 = 001, $V_{\text{IN}} = 0.5V_{\text{PP}}$ 5MHz		-73		dBc	B

ELECTRICAL CHARACTERISTICS (continued)

All Specifications at $T_A = 25^\circ\text{C}$, $V_P = 5\text{V}$, $V_N = -5\text{V}$, $V_B = 0\text{V}$, $V_{\text{sub}} = -5\text{V}$, $R_{\text{LOAD}} = 400\Omega$; $f = 5\text{MHz}$, $B3B2B1 = 111$, $V_{\text{IN}} = 0.25V_{\text{PP}}$, unless otherwise noted. Test Level: A: Final tester limits; B: bench evaluation/simulation; C: Simulation

PARAMETER	TEST CONDITIONS	MIN	TYP	MAX	UNIT	Test Level
2nd Harmonic Distortion, HD2, 10MHz	B3B2B1 = 111, $V_{\text{IN}} = 0.5 V_{\text{PP}}$ 10MHz		-78		dBc	B
	B3B2B1 = 100, $V_{\text{IN}} = 0.5 V_{\text{PP}}$ 10MHz		-77		dBc	B
	B3B2B1 = 001, $V_{\text{IN}} = 0.5 V_{\text{PP}}$ 10MHz		-74		dBc	B
Cross-talk, Xtalk	B3B2B1 = 111 at 10MHz		-70		dBc	B
	B3B2B1 = 100 at 10MHz		-69		dBc	B
	B3B2B1 = 001 at 10MHz		-61		dBc	B
3rd order Intermodulation, IMD3 ⁽¹⁾	B3B2B1 = 111		-68		dBc	B
	B3B2B1 = 100		-65		dBc	B
	B3B2B1 = 001		-50		dBc	B
Power Supply Modulation Ratio, PSMR ⁽²⁾	B3B2B1 = 111		-76		dBc	B
	B3B2B1 = 100		-76		dBc	B
	B3B2B1 = 001		-76		dBc	B
Power Supply Rejection Ratio, PSRR	B3B2B1 = 111, 1KHz and 1MHz		-64		dBc	B
Input Referred Noise, IRN	B3B2B1 = 111		0.91		nV/rtHz	B
	B3B2B1 = 100		1.05		nV/rtHz	B
	B3B2B1 = 001		1.12		nV/rtHz	B
Recovery Time 140 V_{PP} IN, $V_{\text{OUT}} < 20mV_{\text{PP}}$	B3B2B1 = 111		1		μs	B
	B3B2B1 = 100		0.5		μs	B
	B3B2B1 = 001		0.3		μs	B
Turn-on Delay Time ⁽³⁾ , $t_{\text{EN_ON}}$	B3B2B1 = 000→111		0.6		μs	B
	B3B2B1 = 000→100		0.5		μs	B
	B3B2B1 = 000→001		0.5		μs	B
Turn-off Delay Time ⁽³⁾ , $t_{\text{EN_OFF}}$	B3B2B1 = 111→000		2.4		μs	B
	B3B2B1 = 100→000		2.7		μs	B
	B3B2B1 = 001→000		2.2		μs	B
Bias Current Switching Time	B3B2B1 = 001→111		0.7		μs	B
Propagation Delay Time ⁽³⁾ , t_{DELAY}	B3B2B1 = 111		1.3		ns	B
	B3B2B1 = 100		1.6		ns	B
	B3B2B1 = 001		1.7		ns	B
Clamp Voltage, excludes overshoot	B3B2B1 = 111		1.9		V_{PP}	B
	B3B2B1 = 001		1.7		V_{PP}	B
	B3B2B1 = 000		1.4		V_{PP}	B

(1) 5MHz $1V_{\text{PP}}$, and 5.01MHz $0.5V_{\text{PP}}$ input.

(2) PSMR is defined as the ratio between carrier 5MHz and side band signals with 1KHz and 1MHz $50mV_{\text{PP}}$ Noise applied on supply pins.

(3) See the timing diagram show in [Figure 2](#).

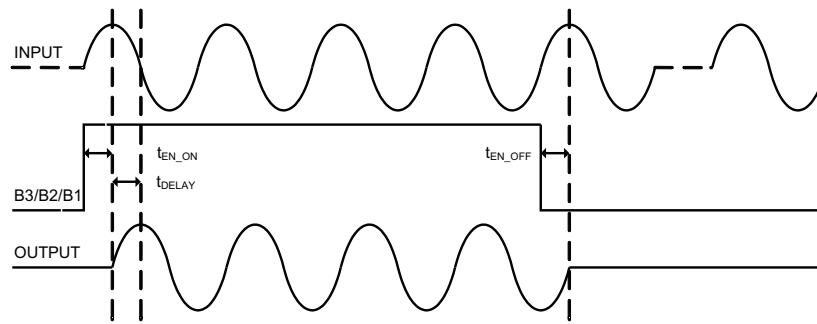

Figure 2. Timing Diagram

TYPICAL CHARACTERISTICS

All Specifications at $T_A = 25^\circ\text{C}$, $V_P = 5\text{V}$, $V_N = -5\text{V}$, $V_B = 0\text{V}$, $V_{SUB} = -5\text{V}$, $R_{IN} = 75\Omega$, $R_{LOAD} = 400\Omega$; $f = 5\text{MHz}$, $B3B2B1=111$, $V_{IN} = 0.25\text{V}_{pp}$, unless otherwise noted.

A typical bench setup is shown in Figure 3.

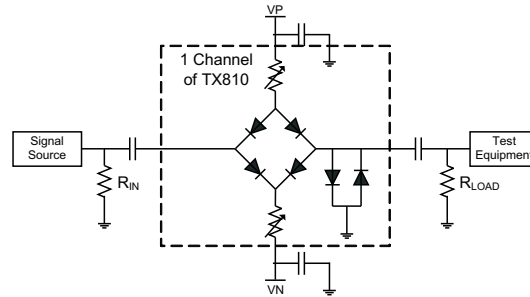

Figure 3. Typical Test Setup

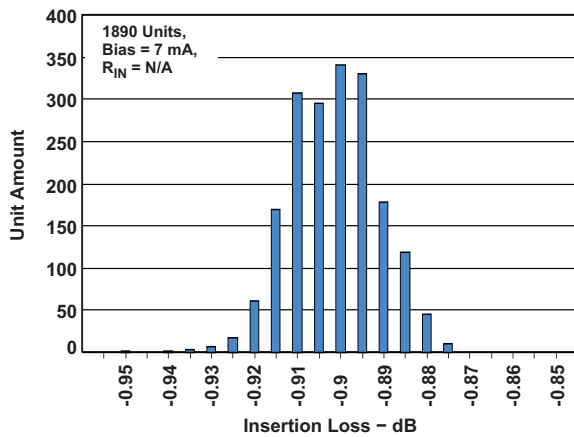
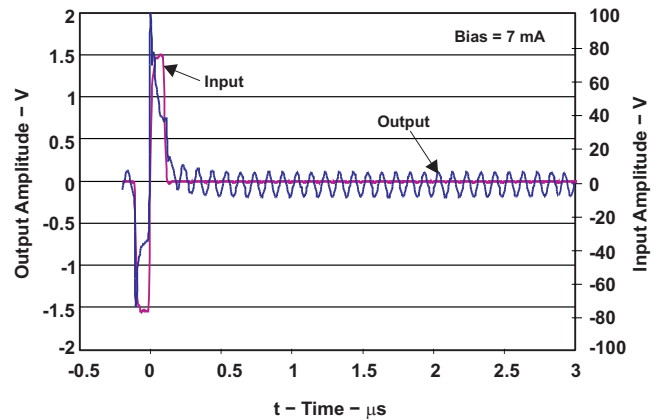

Figure 4. Insertion Loss Distribution



AC coupling is used between High voltage pulser and TX810. The input signal is a combination of 0.25Vpp signal followed by a 1-cycle 140Vpp pulse

Figure 5. Recovery Time With Small Input Signal

TYPICAL CHARACTERISTICS (continued)

All Specifications at $T_A = 25^\circ\text{C}$, $V_P = 5\text{V}$, $V_N = -5\text{V}$, $V_B = 0\text{V}$, $V_{\text{SUB}} = -5\text{V}$, $R_{\text{IN}} = 75\Omega$, $R_{\text{LOAD}} = 400\Omega$; $f = 5\text{MHz}$, $B3B2B1=111$, $V_{\text{IN}} = 0.25V_{\text{PP}}$, unless otherwise noted.

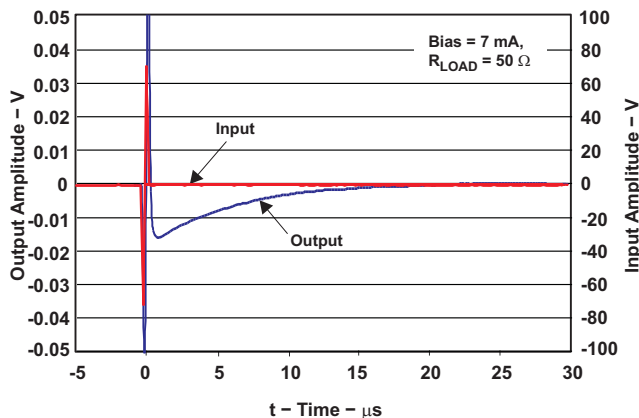

Figure 6. Recovery Time Without Signal

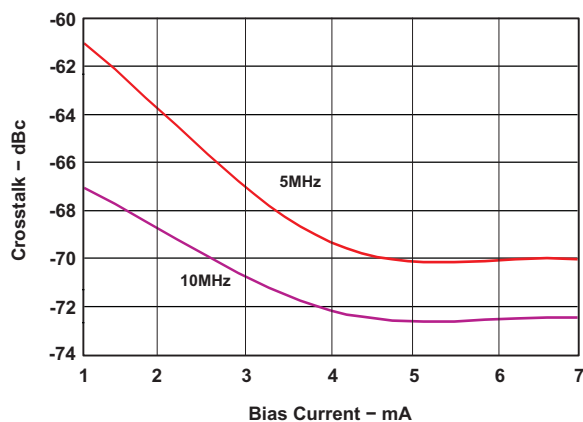

Figure 7. Cross-talk vs. Bias Currents vs. Frequency

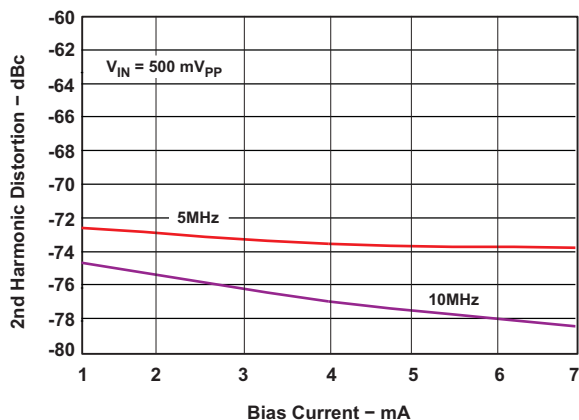

Figure 8. HD2 vs. Bias Current vs. Frequency

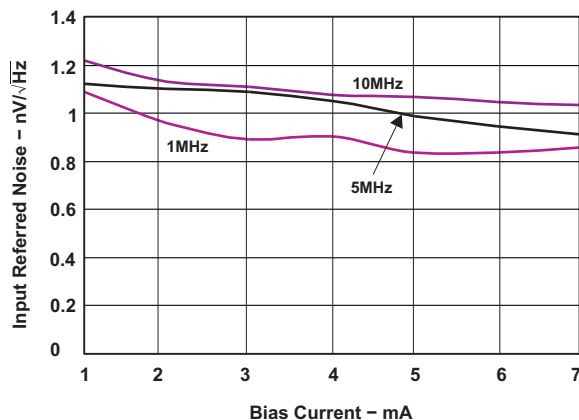

Figure 9. Input Referred Noise vs. Bias Current vs. Frequency

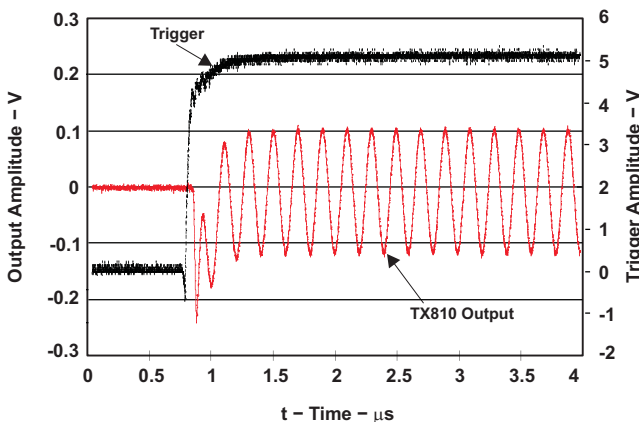

Figure 10. Power On Response Time (0mA to 7mA)

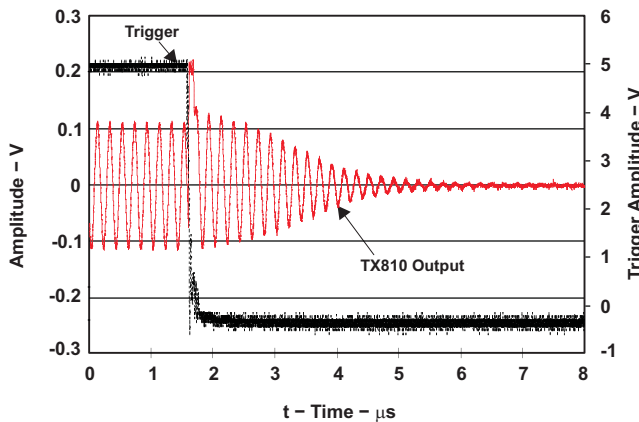

Figure 11. Power Down Response Time (7mA to 0mA)

TYPICAL CHARACTERISTICS (continued)

All Specifications at $T_A = 25^\circ\text{C}$, $V_P = 5\text{V}$, $V_N = -5\text{V}$, $V_B = 0\text{V}$, $V_{\text{SUB}} = -5\text{V}$, $R_{\text{IN}} = 75\Omega$, $R_{\text{LOAD}} = 400\Omega$;
 $f = 5\text{MHz}$, $B3B2B1=111$, $V_{\text{IN}} = 0.25V_{\text{PP}}$, unless otherwise noted.

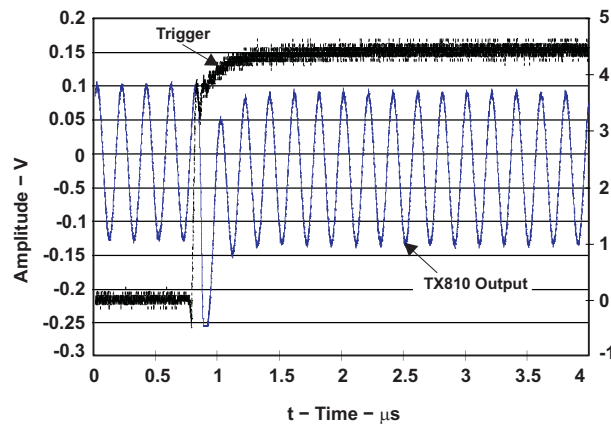

Figure 12. Bias Current Adjustment Response Time (1mA to 7mA)

THEORY OF OPERATION

A typical ultrasound block diagram is shown in Figure 13.

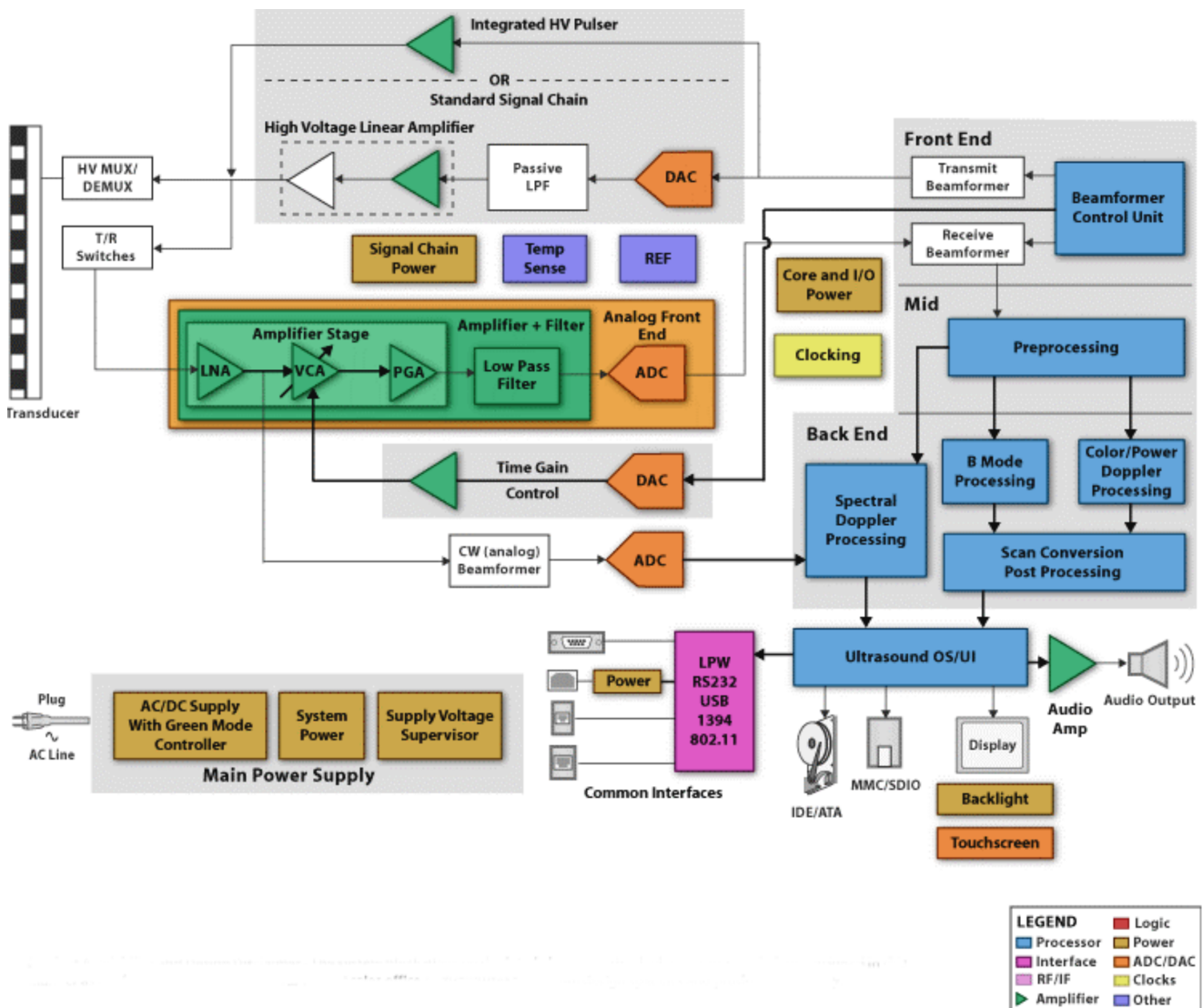

Figure 13. Ultrasound System Block Diagram

A transducer is excited by high voltage pulsers. It converts the electrical energy to mechanical energy. After each excitation, the transducer sends out ultrasonic wave to medium. Partial ultrasonic wave gets reflected by inhomogeneous medium and received by the transducer again, i.e. echo signal. Thus, the transducer is a duplex device on which both high voltage and low voltage signals exist. The transducer can not be connected to amplifier stages directly; otherwise, the high voltage signal can permanently destroy amplifiers. The TX810, i.e. T/R switches, is sitting between integrated HV pulser and low noise amplifier (LNA). The main function of TX810 is to isolate the LNA from high-voltage transmitter. TX810 limits the high voltage pulse and let echo signals reaching amplifier. Therefore, an ideal T/R switch should completely block high voltage signals and maintain all information from echoes.

The detail architecture of the TX810 is listed in Figure 14.

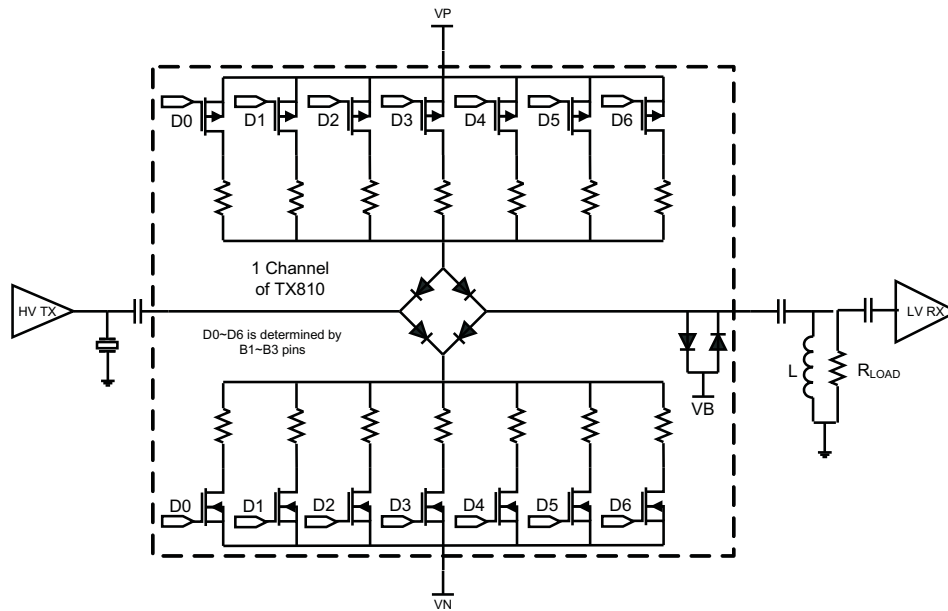

Figure 14. TX810 Block Diagram

TX810 includes four parts: Diode Bridge, bias network, clamp diodes, and logic controller. A decoder is used to convert 3-bit logic (B1 to B3) input to 7 control signals (D0 to D6) for 7 MOSFET switches. +2.5V to +5V logic input is level shifted internally to drive the switches. The bias current of the bridge diode is adjusted proportionally by these switches. When all switches are on, the bias current is 7mA. Each bit difference will adjust the bias current approximately 1mA. When all switches are off, the TX810 enters the power down mode. Comparing to discrete T/R switches, TX810 can be shut down and turned on quickly as shown in the typical characteristics plots. Considering the low duty cycle of ultrasound imaging, significant power saving can be achieved.

All 6 diodes are high-voltage Schottky diodes to achieve fast recovery time. Following the bridge, a pair of back-to-back diode limits the output voltage of TX810 to about 2Vpp. Different power/performance combination can be selected by users. The TX810 is specified to operate at ±5V and VB is biased at 0V. The characteristics of the T/R switch are mainly determined by bias currents. Lower power can be achieved with lower supply voltages. Also, Table 1 shows the relationship among bias current, insertion loss, input noise, power consumption and equivalent resistance.

Table 1. Bias current vs Performance

Test Conditions: VP = 5V, VN = -5V; VB = 0V; R _{LOAD} = 50Ω							
B3	B2	B1	I (mA)	I _L (dB)	IRN (nV/rtHz)	R _{ON} (Ω)	Power (mW/CH)
0	0	0	0	N/A	N/A	High Impedance	0
0	0	1	1	-7	1.12	62	10
0	1	0	2	-5.6	1.10	45	20
0	1	1	3	-5	1.09	39	30
1	0	0	4	-4.6	1.05	35	40
1	0	1	5	-4.4	0.99	33	50
1	1	0	6	-4.2	0.95	31	60
1	1	1	7	-4.1	0.91	30	70

APPLICATION INFORMATION

Similar to discrete T/R switch solutions, external components can be used to optimize system performance. Inductor L and resistor R_{LOAD} before the low voltage receiver amplifier (LVRx) can improve overload recovery time and reduce reflection. The L acts as a high pass filter thus overshoot or recovery response spikes can be suppressed to minimal. The L and R_{LOAD} terminate the entire signal path and can reduce reflection; therefore axial resolution in ultrasound image might be improved. However, the combined impedance of L and R_{LOAD} may affect the system sensitivity. The insertion loss of T/R switch is determined by the input impedance of receiver amplifier and R_{ON} of the TX810. L also creates a DC path for any offset caused by mismatching. The inductor can be as low as 10s μ H to suppress low frequency signals from transmitter, transducer, multiplexer, and TX810. The optimization of L and R_{LOAD} is always an important topic for system designers. AC coupling are typically used between transmitter and T/R switch or T/R switch and amplifier. Thus amplifiers with DC biased inputs will not interference with T/R switch.

One challenge for integrating multiple channel circuits on a small package is how to reduce cross talk. In ultrasound systems, acoustic cross talk from adjacent transducer elements is a dominant source. The cross talk from transducer elements is in a range of -30 to -35dBc for array transducers. Circuit cross talk is usually at least 20dB better than the transducer cross talk. The special considerations were implemented in both TX810 design and layout. The cross talk among TX810 channels is reduced to below -60 dBc as show in the specification table.

In ultrasound Doppler applications, modulation effect in system can influence image quality and sensitivity. Ultrasound system is a complex mixed-signal system with all kinds of digital and analog circuits. Digital signals and clock signals can contaminate analog signals on system level or on chip level. Nonlinear components, such as transistors and diodes, can modulate noise and contaminate signals. In Doppler applications, the Doppler signal frequency could range from 20Hz to >50KHz. Meanwhile, multiple system clocks are also in this range, such as frame clock, image line clock, and etc. These noise signals could enter chip through ground and power supply pins. It is important to study the power supply modulation ratio (PSMR) at chip level. Noise signal with certain frequency and amplitude can be applied on supply pins. Side band signals could be found if modulation effect exists. The PSMR is expressed as an amplitude ratio between carrier and side band signals. Beside PSMR, 3rd order intermodulation ratio (IMD3) is a standard specification for mixed-signal ICs. Users can use IMD3 to estimate the potential artifact Doppler mirror signals. Both specs can be found in the specification table.

The schematic of the basic connection for TX810 is shown in [Figure 15](#). Optional inductors and resistors can be used at TX810 outputs depending on transducer characteristics as discussed above. Standard decoupling capacitors 0.1 μ F should be placed close to power supply pins. The pin out of TX810 is optimized for PCB layout. All signals are going from left to right straightly.

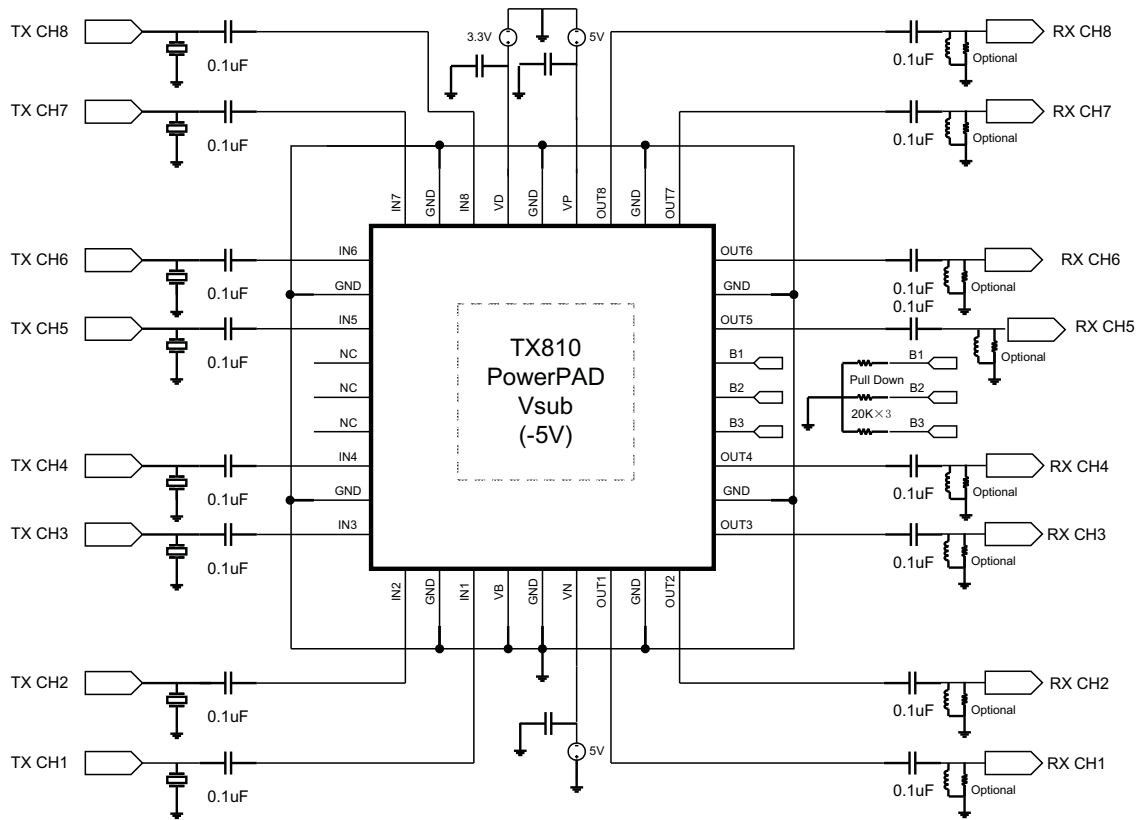

Figure 15. Schematic of TX810

REVISION HISTORY

Changes from Original (September 2009) to Revision A

Page

- Changed From: Product Preview To: Production. The Product Preview was a two page data sheet containing the front page and the pin out section 1

PACKAGING INFORMATION

Orderable Device	Status (1)	Package Type	Package Drawing	Pins	Package Qty	Eco Plan (2)	Lead finish/ Ball material (6)	MSL Peak Temp (3)	Op Temp (°C)	Device Marking (4/5)	Samples
TX810IRHHT	ACTIVE	VQFN	RHH	36	250	RoHS & Green	NIPDAU	Level-2-260C-1 YEAR	0 to 70	TX810	Samples

(1) The marketing status values are defined as follows:

ACTIVE: Product device recommended for new designs.

LIFEBUY: TI has announced that the device will be discontinued, and a lifetime-buy period is in effect.

NRND: Not recommended for new designs. Device is in production to support existing customers, but TI does not recommend using this part in a new design.

PREVIEW: Device has been announced but is not in production. Samples may or may not be available.

OBSOLETE: TI has discontinued the production of the device.

(2) **RoHS:** TI defines "RoHS" to mean semiconductor products that are compliant with the current EU RoHS requirements for all 10 RoHS substances, including the requirement that RoHS substance do not exceed 0.1% by weight in homogeneous materials. Where designed to be soldered at high temperatures, "RoHS" products are suitable for use in specified lead-free processes. TI may reference these types of products as "Pb-Free".

RoHS Exempt: TI defines "RoHS Exempt" to mean products that contain lead but are compliant with EU RoHS pursuant to a specific EU RoHS exemption.

Green: TI defines "Green" to mean the content of Chlorine (Cl) and Bromine (Br) based flame retardants meet JS709B low halogen requirements of <=1000ppm threshold. Antimony trioxide based flame retardants must also meet the <=1000ppm threshold requirement.

(3) MSL, Peak Temp. - The Moisture Sensitivity Level rating according to the JEDEC industry standard classifications, and peak solder temperature.

(4) There may be additional marking, which relates to the logo, the lot trace code information, or the environmental category on the device.

(5) Multiple Device Markings will be inside parentheses. Only one Device Marking contained in parentheses and separated by a "-" will appear on a device. If a line is indented then it is a continuation of the previous line and the two combined represent the entire Device Marking for that device.

(6) Lead finish/Ball material - Orderable Devices may have multiple material finish options. Finish options are separated by a vertical ruled line. Lead finish/Ball material values may wrap to two lines if the finish value exceeds the maximum column width.

Important Information and Disclaimer:The information provided on this page represents TI's knowledge and belief as of the date that it is provided. TI bases its knowledge and belief on information provided by third parties, and makes no representation or warranty as to the accuracy of such information. Efforts are underway to better integrate information from third parties. TI has taken and continues to take reasonable steps to provide representative and accurate information but may not have conducted destructive testing or chemical analysis on incoming materials and chemicals. TI and TI suppliers consider certain information to be proprietary, and thus CAS numbers and other limited information may not be available for release.

In no event shall TI's liability arising out of such information exceed the total purchase price of the TI part(s) at issue in this document sold by TI to Customer on an annual basis.

TAPE AND REEL INFORMATION

QUADRANT ASSIGNMENTS FOR PIN 1 ORIENTATION IN TAPE

*All dimensions are nominal

Device	Package Type	Package Drawing	Pins	SPQ	Reel Diameter (mm)	Reel Width W1 (mm)	A0 (mm)	B0 (mm)	K0 (mm)	P1 (mm)	W (mm)	Pin1 Quadrant
TX810IRHHT	VQFN	RHH	36	250	180.0	16.4	6.3	6.3	1.5	12.0	16.0	Q2

TAPE AND REEL BOX DIMENSIONS

*All dimensions are nominal

Device	Package Type	Package Drawing	Pins	SPQ	Length (mm)	Width (mm)	Height (mm)
TX810IRHHT	VQFN	RHH	36	250	213.0	191.0	55.0

GENERIC PACKAGE VIEW

RHH 36

VQFN - 1 mm max height

6 x 6, 0.5 mm pitch

PLASTIC QUAD FLATPACK - NO LEAD

This image is a representation of the package family, actual package may vary.
Refer to the product data sheet for package details.

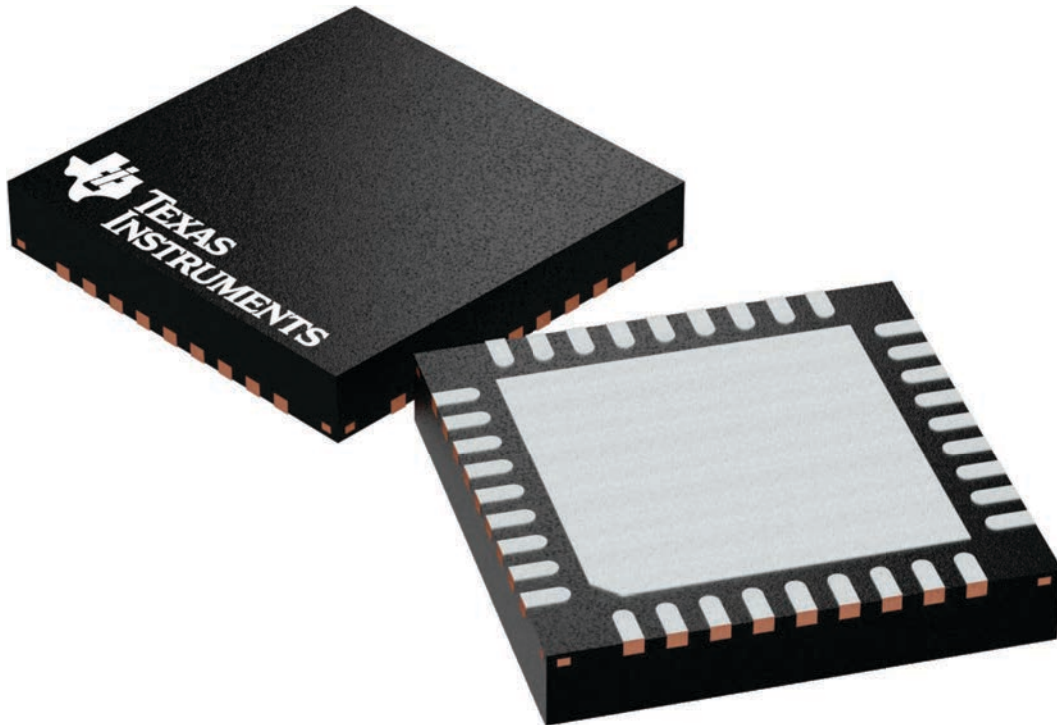

4225440/A

RHH0036B

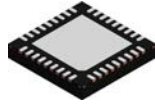

PACKAGE OUTLINE

VQFN - 1 mm max height

PLASTIC QUAD FLATPACK - NO LEAD

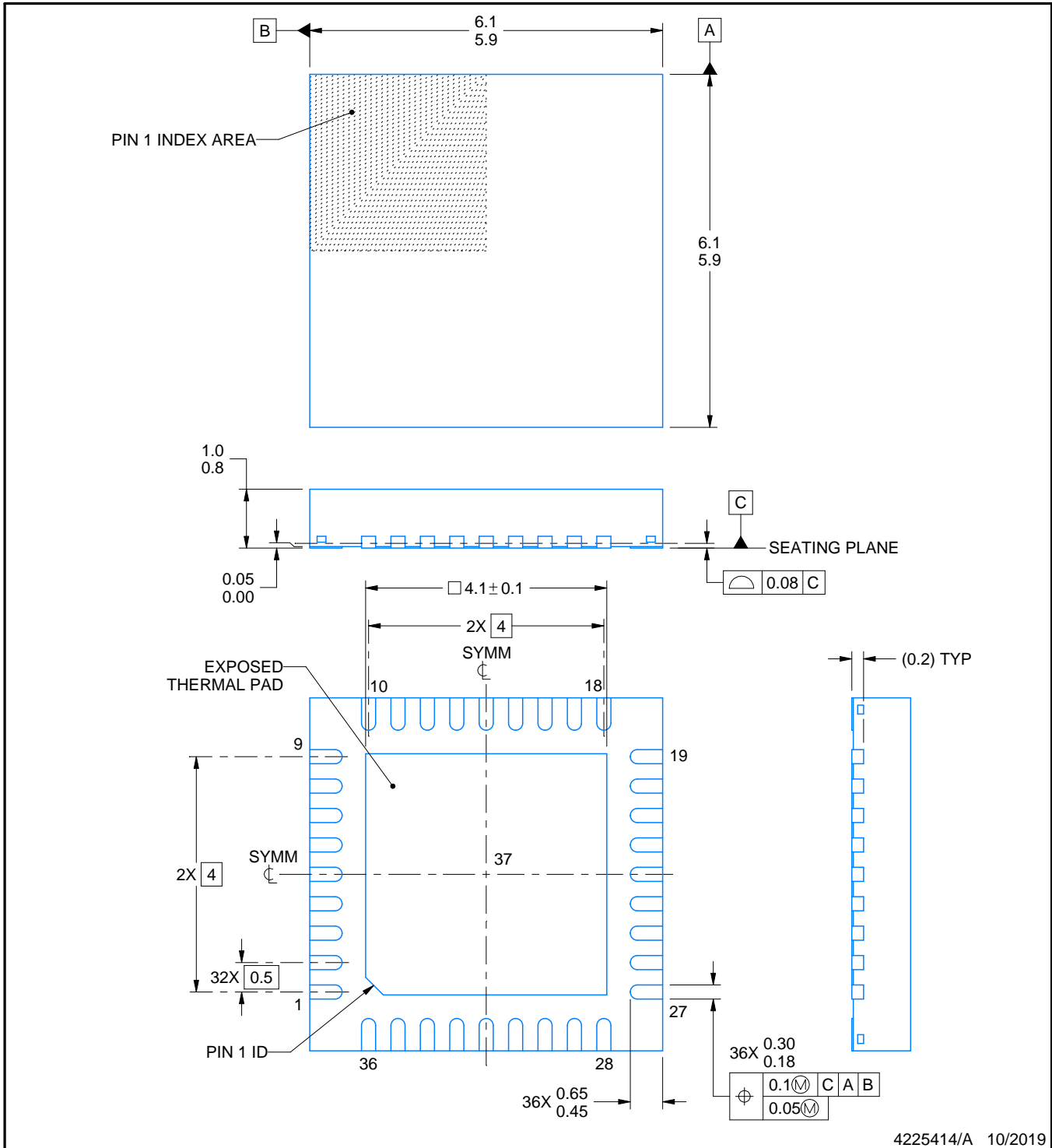

NOTES:

1. All linear dimensions are in millimeters. Any dimensions in parenthesis are for reference only. Dimensioning and tolerancing per ASME Y14.5M.
2. This drawing is subject to change without notice.
3. The package thermal pad must be soldered to the printed circuit board for thermal and mechanical performance.

EXAMPLE BOARD LAYOUT

RHH0036B

VQFN - 1 mm max height

PLASTIC QUAD FLATPACK - NO LEAD

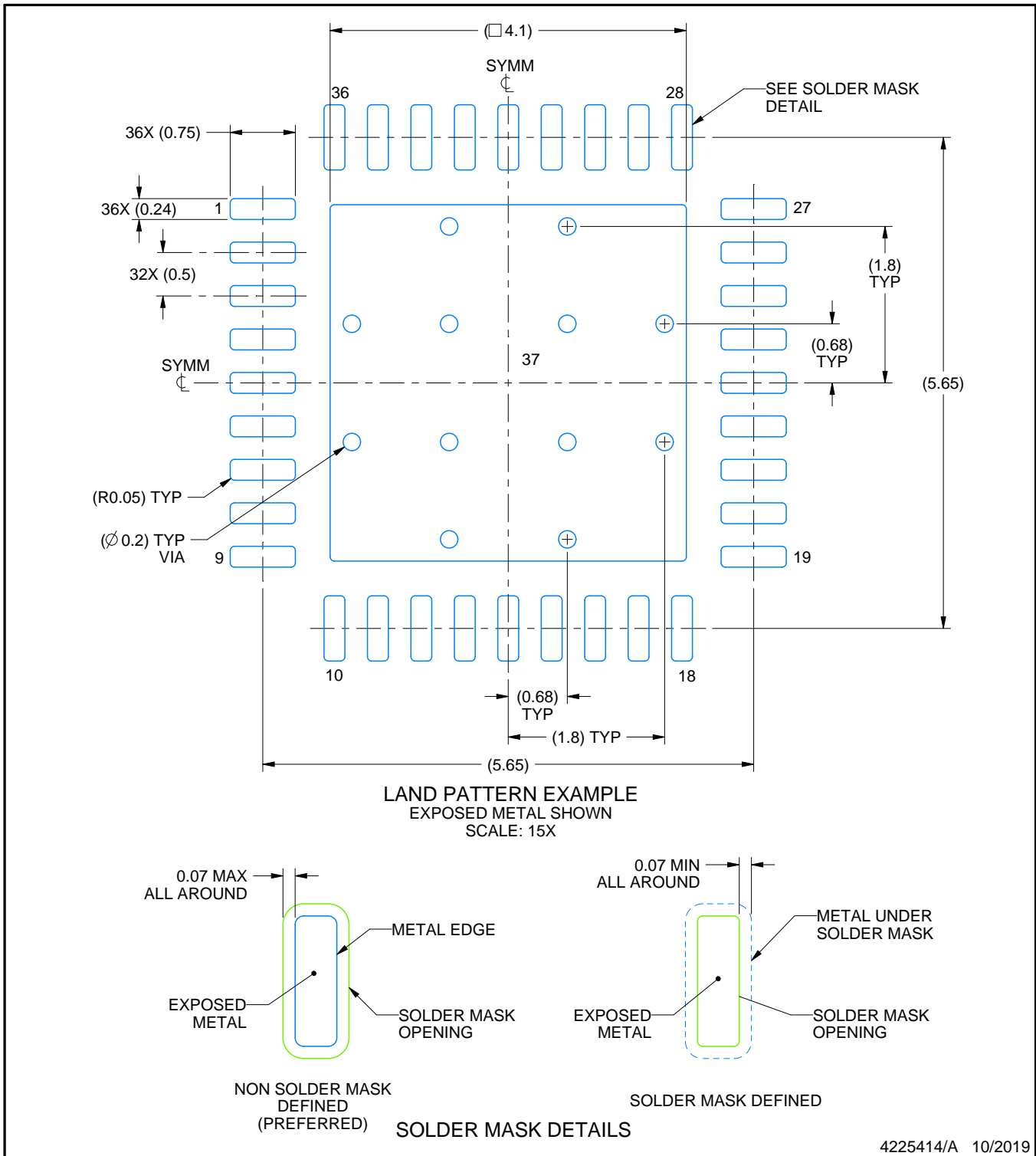

4225414/A 10/2019

NOTES: (continued)

4. This package is designed to be soldered to a thermal pad on the board. For more information, see Texas Instruments literature number SLUA271 (www.ti.com/lit/sl原因271).
5. Vias are optional depending on application, refer to device data sheet. If any vias are implemented, refer to their locations shown on this view. It is recommended that vias under paste be filled, plugged or tented.

EXAMPLE STENCIL DESIGN

RHH0036B

VQFN - 1 mm max height

PLASTIC QUAD FLATPACK - NO LEAD

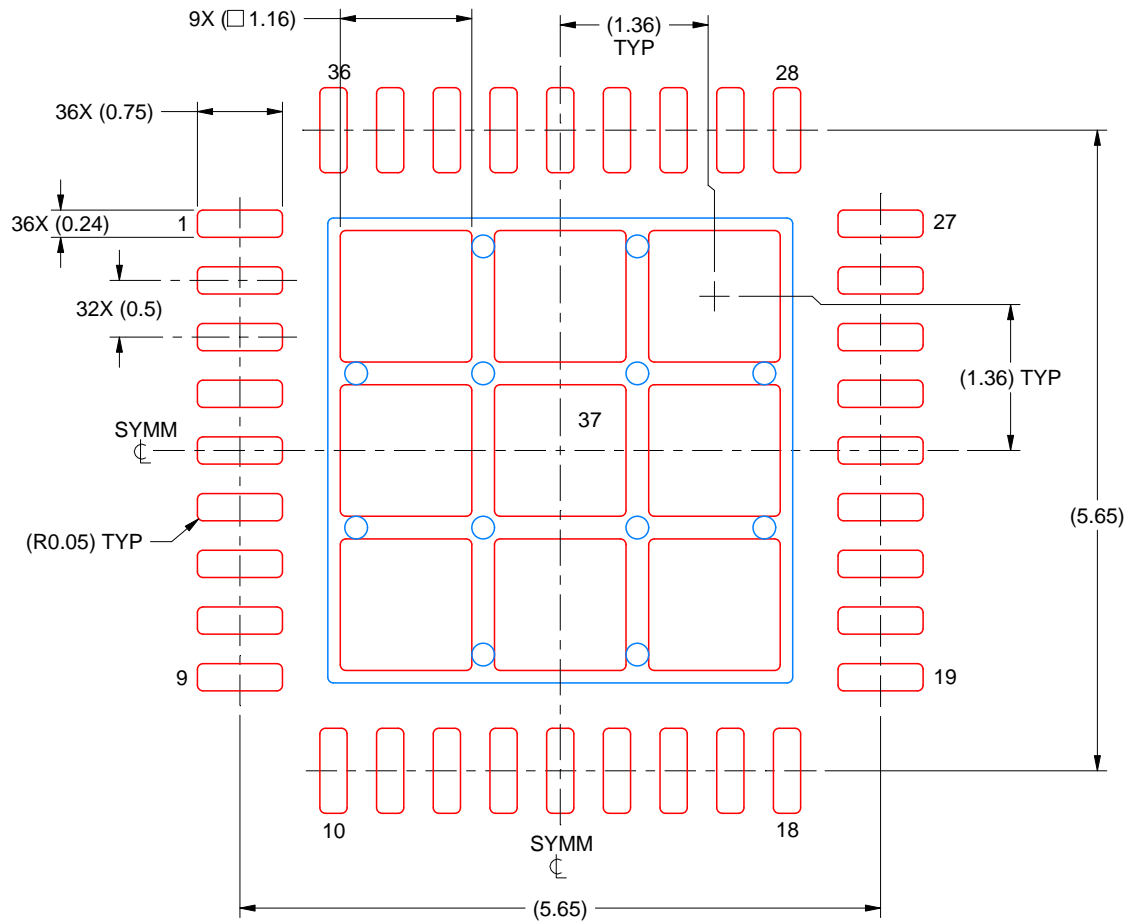

SOLDER PASTE EXAMPLE
BASED ON 0.125 MM THICK STENCIL
SCALE: 15X

EXPOSED PAD 37
72% PRINTED SOLDER COVERAGE BY AREA UNDER PACKAGE

4225414/A 10/2019

NOTES: (continued)

6. Laser cutting apertures with trapezoidal walls and rounded corners may offer better paste release. IPC-7525 may have alternate design recommendations.

IMPORTANT NOTICE AND DISCLAIMER

TI PROVIDES TECHNICAL AND RELIABILITY DATA (INCLUDING DATASHEETS), DESIGN RESOURCES (INCLUDING REFERENCE DESIGNS), APPLICATION OR OTHER DESIGN ADVICE, WEB TOOLS, SAFETY INFORMATION, AND OTHER RESOURCES "AS IS" AND WITH ALL FAULTS, AND DISCLAIMS ALL WARRANTIES, EXPRESS AND IMPLIED, INCLUDING WITHOUT LIMITATION ANY IMPLIED WARRANTIES OF MERCHANTABILITY, FITNESS FOR A PARTICULAR PURPOSE OR NON-INFRINGEMENT OF THIRD PARTY INTELLECTUAL PROPERTY RIGHTS.

These resources are intended for skilled developers designing with TI products. You are solely responsible for (1) selecting the appropriate TI products for your application, (2) designing, validating and testing your application, and (3) ensuring your application meets applicable standards, and any other safety, security, or other requirements. These resources are subject to change without notice. TI grants you permission to use these resources only for development of an application that uses the TI products described in the resource. Other reproduction and display of these resources is prohibited. No license is granted to any other TI intellectual property right or to any third party intellectual property right. TI disclaims responsibility for, and you will fully indemnify TI and its representatives against, any claims, damages, costs, losses, and liabilities arising out of your use of these resources.

TI's products are provided subject to TI's Terms of Sale (<https://www.ti.com/legal/termsofsale.html>) or other applicable terms available either on [ti.com](https://www.ti.com) or provided in conjunction with such TI products. TI's provision of these resources does not expand or otherwise alter TI's applicable warranties or warranty disclaimers for TI products.

Mailing Address: Texas Instruments, Post Office Box 655303, Dallas, Texas 75265
Copyright © 2021, Texas Instruments Incorporated