



宏齐光电子(深圳)有限公司  
HARVATEK OPTO-ELECTRONICS (SHENZHEN) CO., LTD.

# 产品规格书

## SPECIFICATION

|                      |   |                     |           |
|----------------------|---|---------------------|-----------|
| 产品名称<br>Product Name | 0603-0.6T 白色发光二极管<br>0603-0.6T White Chip LED | 客户名称<br>Customer    |           |
| 产品型号<br>Type         | HQ19-2132UWCC                                 | 客户料号<br>Customer PN |           |
| 版本号<br>Version       | C1  | 日期<br>Date          | 2019/4/30 |

节能减排  
卓越创新



| 客户承认栏<br>Customer Approval   |             |               |               |
|--|-------------|---------------|---------------|
| 制定<br>DRAW   | 审核<br>CHECK | 核准<br>APPROVE | 确认<br>CONFIRM |
|  |             |               |               |
| 若英文译本与中文有异, 以中文版本为准。<br>Should there be any inconsistencies between Chinese and English versions, the Chinese version shall prevail. |             |               |               |



产品命名规则/Description of product name

举例说明/Example

| HQ | 19 - 2132 | SUR | C | XX |                                   |   |
|----|-----------|-----|---|----|-----------------------------------|---|
|    |           |     |   |    | 流水码<br>Serial No                  |   |
|    |           |     |   |    | 代表胶体颜色<br>Lens color              | C: 透明/ water clear<br>W: 代表雾状/ diffuse<br>D: 代表有色/ color  |
|    |           |     |   |    | 发光颜色<br>Emitter Color             | SUR: 红色/Red<br>UY: 黄色/Yellow<br>SYG: 黄绿色/Yellow Green<br>UBG: 翠绿色/Green,<br>UB: 蓝色/Blue<br>UW: 白光/white,<br>UWA: 暖白/warm white                                      |
|    |           |     |   |    | 代表产品系列号<br>Product Series No      | 19-2101: 0603-0.8T<br>19-2132: 0603-0.6T<br>19-2151: 0603-0.4T<br>17-2102: 0805-1.1T<br>15-2102: 1206-1.1T  |
|    |           |     |   |    | 产品主系列号<br>Product major series No | 12: 1206 侧面系列/1206side<br>15: 1206 正面系列/1206 series<br>16: 0402 系列/ 0402 series<br>17: 0805 系列/ 0805 series<br>19: 0603 系列/ 0603 series<br>67: 3528 系列/ 3528 series |
|    |           |     |   |    | 代表宏齐光公司<br>Company Name           |   |



## 1、产品描述/ Features

- 外观尺寸/ Package ( L/W/H ) :1.6x0.8x0.55mm
- 颜色/ Color: 高亮白光 / Ultra Bright Standard White
- 胶体/ Lens: 黄色平面胶体/ Yellow Clear Flat Mold
- EIA规范标准包装/ EIA STD Package
- 环保产品, 符合ROHS要求/ Meet ROHS, Green Product
- 防潮等级:Level 3 / Moisture sensitivity: Level 3
- 适用于SMT组装和焊接工艺制程/ Compatible With SMT Assembly and solder process

## 2、外形尺寸及建议焊盘尺寸/ Package Profile & Soldering PAD Suggested

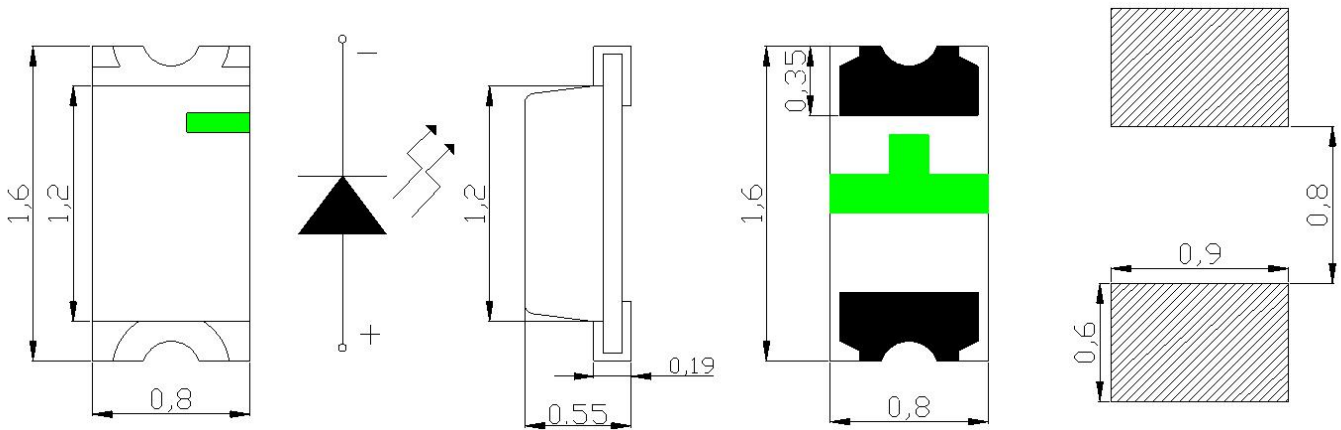

- 注/ Notes: 1. 单位 : 毫米 (mm) / All dimensions are in millimeters  
2. 公差 : 如无特别标注则为 $\pm 0.1$  mm Tolerance is  $\pm 0.10$  mm unless otherwise noted

## 3、建议焊接温度曲线 / Soldering Profile Suggested

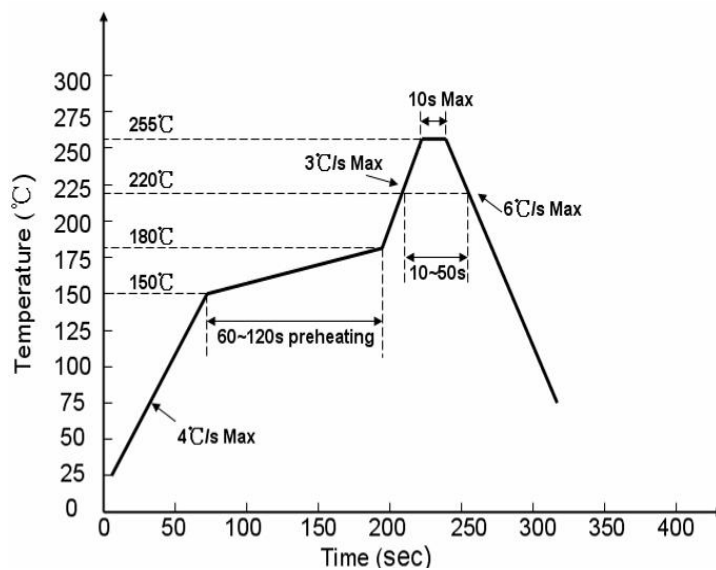

无铅焊接/ For Lead Free Solder



## 4、最大绝对额定值/ Absolute Maximum Ratings (Ta=25°C)

| 参数<br>Parameter                                      | 符号<br>Symbol | 最大额定值<br>Rating   | 单位<br>Unit |
|--|--------------|---|------------|
| 消耗功率<br>Power Dissipation                            | Pd           | 90  | mW         |
| 最大脉冲电流/ Peak Forward Current<br>(1/10 占空比, 0.1ms 脉宽) | IFP          | 100   | mA         |
| 正向直流工作电流<br>DC Forward Current                       | IF           | 25  | mA         |
| 反向电压<br>Reverse Voltage                              | VR           | 5   | V          |
| 工作环境温度<br>Operating Temperature Range                | Topr         | -30°C ~ + 85°C  |            |
| 存储环境温度<br>Storage Temperature Range                  | Tstg         | -40°C ~ + 90°C  |            |
| 焊接条件<br>Soldering Condition                          | Tsol         | 回流焊/ Reflow soldering : 260°C , 10s<br>手动焊/ Hand soldering : 300°C , 3s |            |
| 抗静电能力<br>Electrostatic Discharge                     | ESD          | 2000  | V          |

## 5、光电参数/ Electrical Optical Characteristics (Ta=25°C)

| 参数<br>Parameter            | 符号<br>Symbol | 最小值<br>Min. | 代表值<br>Typ. | 最大值<br>Max. | 单位<br>Unit | 测试条件<br>Test Condition |
|----------------------------|--------------|-------------|-------------|-------------|------------|------------------------|
| 光强<br>Luminous Intensity   | IV           | --          | 285         | --          | mcd        | IF = 5mA               |
| 半光强视角<br>Viewing Angle     | 2θ1/2        | ---         | 120         | ---         | deg        | IF = 5mA               |
| 色座标<br>CIE 1931 Coordinate | X            | ---         | 0.31        | ----        | ---        | IF = 5mA               |
|                            | Y            | ---         | 0.315       | ---         | ---        | IF = 5mA               |
| 色温<br>Color Temperature    | CCT          | 5500        | ---         | 9000        | K          | IF = 5mA               |
| 正向电压<br>Forward Voltage    | VF           | 2.5         | ---         | 3.2         | V          | IF = 5mA               |
| 反向电流<br>Reverse Current    | IR           | ---         | ---         | 5           | μA         | VR = 5V                |



### 5-1、亮度分 BIN 规格/ Bin Range of Luminous Intensity

| Bin | Min | Max | Unit | Condition |
|-----|-----|-----|------|-----------|
| M1  | 180 | 230 | MCD  | IF = 5mA  |
| M2  | 230 | 285 |      |           |
| N1  | 285 | 350 |      |           |
| N2  | 350 | 450 |      |           |
| P1  | 450 | 560 |      |           |

Notes: Tolerance of Luminous Intensity:  $\pm 10\%$

### 5-2、电压分 BIN 规格/ Bin Range of Forward Voltage

| Bin | Min | Max | Unit | Condition |
|-----|-----|-----|------|-----------|
| 5A  | 2.6 | 2.7 | V    | IF = 5mA  |
| 5B  | 2.7 | 2.8 |      |           |
| 6A  | 2.8 | 2.9 |      |           |
| 6B  | 2.9 | 3.0 |      |           |
| 7A  | 3.0 | 3.1 |      |           |

Notes: Tolerance of Forward Voltage:  $\pm 0.05V$

### 5-3、色区分 BIN 规格/ Bin Range of Color Area

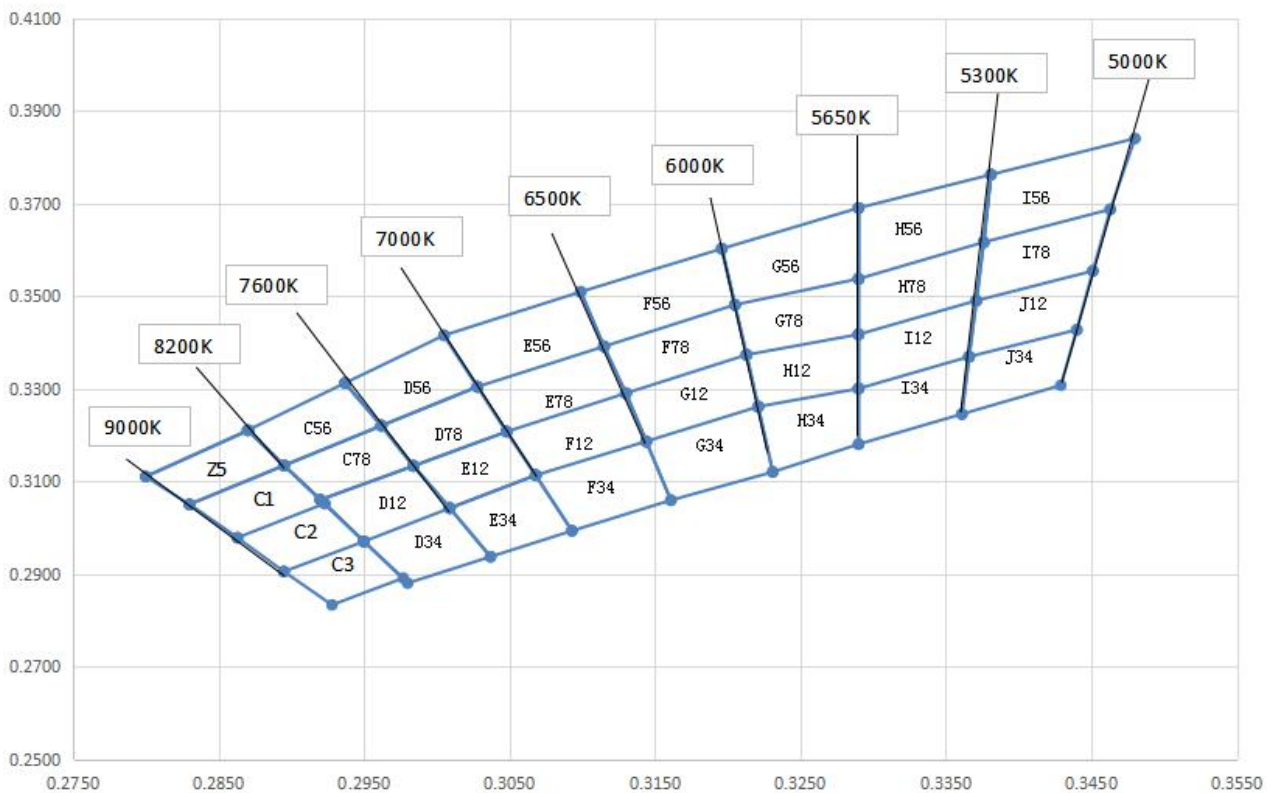



宏齐光电子(深圳)有限公司

HARVATEK OPTO-ELECTRONICS (SHENZHEN) CO., LTD.

| Bin Code | CIE-X  | CIE-Y  | Bin Code | CIE-X  | CIE-Y  | Bin Code | CIE-X  | CIE-Y  | Bin Code | CIE-X  | CIE-Y  |
|----------|--------|--------|----------|--------|--------|----------|--------|--------|----------|--------|--------|
| Z5       | 0.28   | 0.311  | C1       | 0.2830 | 0.3050 | C2       | 0.2863 | 0.2978 | C3       | 0.2895 | 0.2905 |
|          | 0.2871 | 0.321  |          | 0.2863 | 0.2978 |          | 0.2895 | 0.2905 |          | 0.2928 | 0.2833 |
|          | 0.2895 | 0.3134 |          | 0.2923 | 0.3052 |          | 0.2950 | 0.2970 |          | 0.2977 | 0.2891 |
|          | 0.283  | 0.305  |          | 0.2895 | 0.3134 |          | 0.2923 | 0.3052 |          | 0.2950 | 0.2970 |
| C56      | 0.2870 | 0.3210 | C78      | 0.2920 | 0.3060 | D12      | 0.2950 | 0.2970 | D34      | 0.2950 | 0.2970 |
|          | 0.2937 | 0.3312 |          | 0.2895 | 0.3134 |          | 0.2920 | 0.3060 |          | 0.2980 | 0.2880 |
|          | 0.2962 | 0.3220 |          | 0.2962 | 0.3220 |          | 0.2984 | 0.3133 |          | 0.3037 | 0.2937 |
|          | 0.2895 | 0.3134 |          | 0.2984 | 0.3133 |          | 0.3009 | 0.3042 |          | 0.3009 | 0.3042 |
| D56      | 0.2937 | 0.3312 | D78      | 0.2962 | 0.3220 | E12      | 0.2984 | 0.3133 | E34      | 0.3009 | 0.3042 |
|          | 0.2962 | 0.3220 |          | 0.2984 | 0.3133 |          | 0.3009 | 0.3042 |          | 0.3037 | 0.2937 |
|          | 0.3028 | 0.3304 |          | 0.3048 | 0.3207 |          | 0.3068 | 0.3113 |          | 0.3093 | 0.2993 |
|          | 0.3005 | 0.3415 |          | 0.3028 | 0.3304 |          | 0.3048 | 0.3207 |          | 0.3068 | 0.3113 |
| E56      | 0.3028 | 0.3304 | E78      | 0.3048 | 0.3207 | F12      | 0.3068 | 0.3113 | F34      | 0.3068 | 0.3113 |
|          | 0.3005 | 0.3415 |          | 0.3028 | 0.3304 |          | 0.3048 | 0.3207 |          | 0.3093 | 0.2993 |
|          | 0.3099 | 0.3509 |          | 0.3115 | 0.3391 |          | 0.3130 | 0.3290 |          | 0.3161 | 0.3059 |
|          | 0.3115 | 0.3391 |          | 0.3130 | 0.3290 |          | 0.3144 | 0.3186 |          | 0.3144 | 0.3186 |
| F56      | 0.3115 | 0.3391 | F78      | 0.3130 | 0.3290 | G12      | 0.3130 | 0.3290 | G34      | 0.3144 | 0.3186 |
|          | 0.3099 | 0.3509 |          | 0.3115 | 0.3391 |          | 0.3144 | 0.3186 |          | 0.3161 | 0.3059 |
|          | 0.3196 | 0.3602 |          | 0.3205 | 0.3481 |          | 0.3221 | 0.3261 |          | 0.3231 | 0.3120 |
|          | 0.3205 | 0.3481 |          | 0.3213 | 0.3373 |          | 0.3213 | 0.3373 |          | 0.3221 | 0.3261 |
| G56      | 0.3196 | 0.3602 | G78      | 0.3205 | 0.3481 | H12      | 0.3213 | 0.3373 | H34      | 0.3221 | 0.3261 |
|          | 0.3205 | 0.3481 |          | 0.3213 | 0.3373 |          | 0.3221 | 0.3261 |          | 0.3231 | 0.312  |
|          | 0.3290 | 0.3537 |          | 0.3290 | 0.3417 |          | 0.3290 | 0.3300 |          | 0.3290 | 0.3180 |
|          | 0.3290 | 0.3690 |          | 0.3290 | 0.3537 |          | 0.3290 | 0.3417 |          | 0.3290 | 0.3300 |
| H56      | 0.3290 | 0.3690 | H78      | 0.3290 | 0.3537 | I12      | 0.3290 | 0.3417 | I34      | 0.3290 | 0.3300 |
|          | 0.3290 | 0.3537 |          | 0.3290 | 0.3417 |          | 0.3290 | 0.3300 |          | 0.3290 | 0.3180 |
|          | 0.3376 | 0.3616 |          | 0.3371 | 0.3490 |          | 0.3366 | 0.3369 |          | 0.3361 | 0.3245 |
|          | 0.3381 | 0.3762 |          | 0.3376 | 0.3616 |          | 0.3371 | 0.3490 |          | 0.3366 | 0.3369 |
| I56      | 0.3381 | 0.3762 | I78      | 0.3376 | 0.3616 | J12      | 0.3371 | 0.3490 | J34      | 0.3366 | 0.3369 |
|          | 0.3376 | 0.3616 |          | 0.3371 | 0.3490 |          | 0.3366 | 0.3369 |          | 0.3361 | 0.3245 |
|          | 0.3463 | 0.3687 |          | 0.3451 | 0.3554 |          | 0.3440 | 0.3427 |          | 0.3429 | 0.3307 |
|          | 0.3480 | 0.3840 |          | 0.3463 | 0.3687 |          | 0.3451 | 0.3554 |          | 0.3440 | 0.3427 |
|          |        |        |          |        |        |          |        |        |          |        |        |
|          |        |        |          |        |        |          |        |        |          |        |        |
|          |        |        |          |        |        |          |        |        |          |        |        |
|          |        |        |          |        |        |          |        |        |          |        |        |
|          |        |        |          |        |        |          |        |        |          |        |        |
|          |        |        |          |        |        |          |        |        |          |        |        |
|          |        |        |          |        |        |          |        |        |          |        |        |
|          |        |        |          |        |        |          |        |        |          |        |        |
|          |        |        |          |        |        |          |        |        |          |        |        |
|          |        |        |          |        |        |          |        |        |          |        |        |
|          |        |        |          |        |        |          |        |        |          |        |        |



## 6、光电参数代表值特征曲线/ Typical Electrical-Optical Characteristics Curves:

光谱分布特性曲线  
Spectrum Distribution (Ta=25°C)

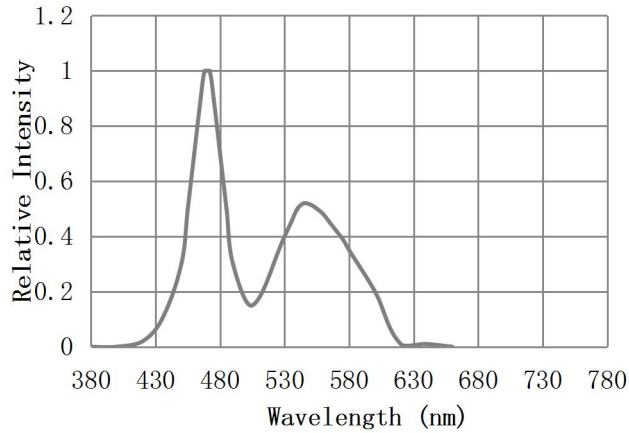

伏安特性曲线  
Forward Current VS. Forward Voltage (Ta=25°C)

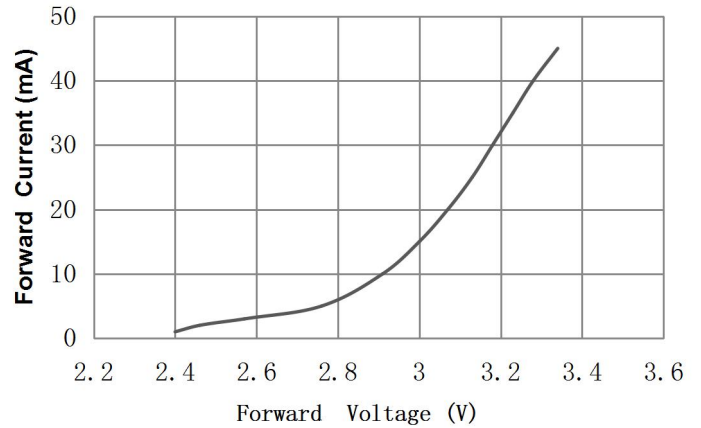

相对光强与电流特性曲线  
Relative Intensity VS. Forward Current (Ta=25°C)

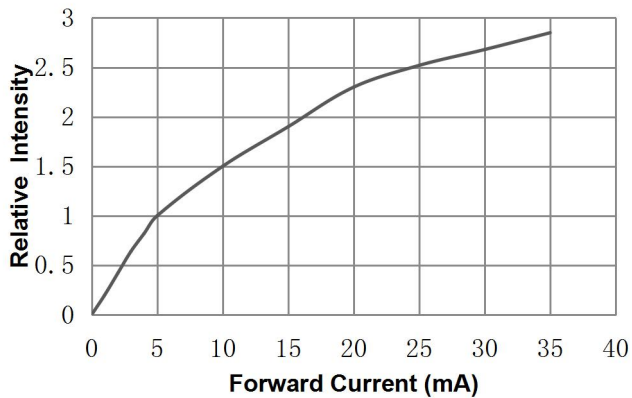

相对光强与环境温度特性曲线  
Relative Intensity VS. Ambient Temperature (Ta=25°C)

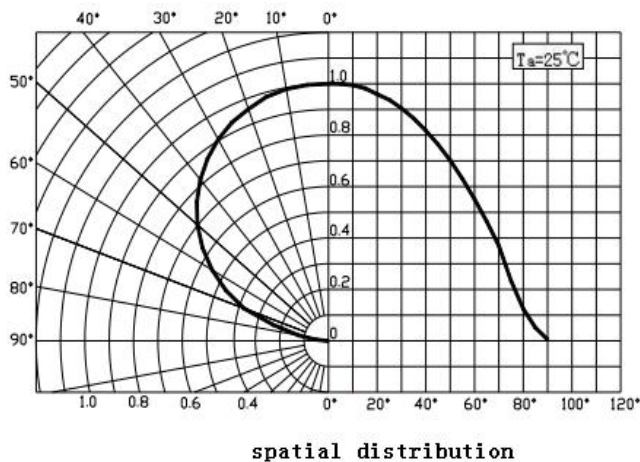
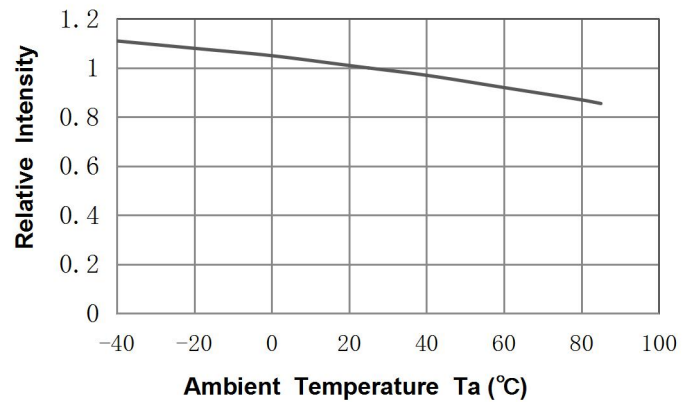

最大正向电流与环境温度特性曲线  
Maximum Forward Current VS. Ambient temperature

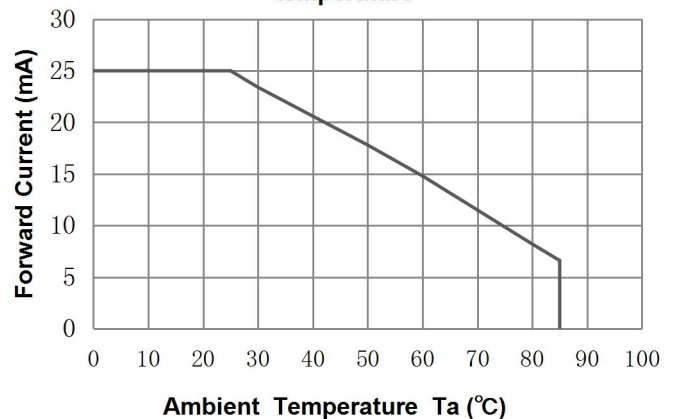



### 7、标签及标识/ Label Explanation:

CAT: 光强/ Luminous Intensity Rank (单位 (mcd))

HUE: 波长/ CIE 1931 Coordinate Rank (单位 (nm))

REF: 电压/ Forward Voltage Rank (单位 (V))



### 8、包装载带与圆盘尺寸/ Reel And Tape Dimensions:

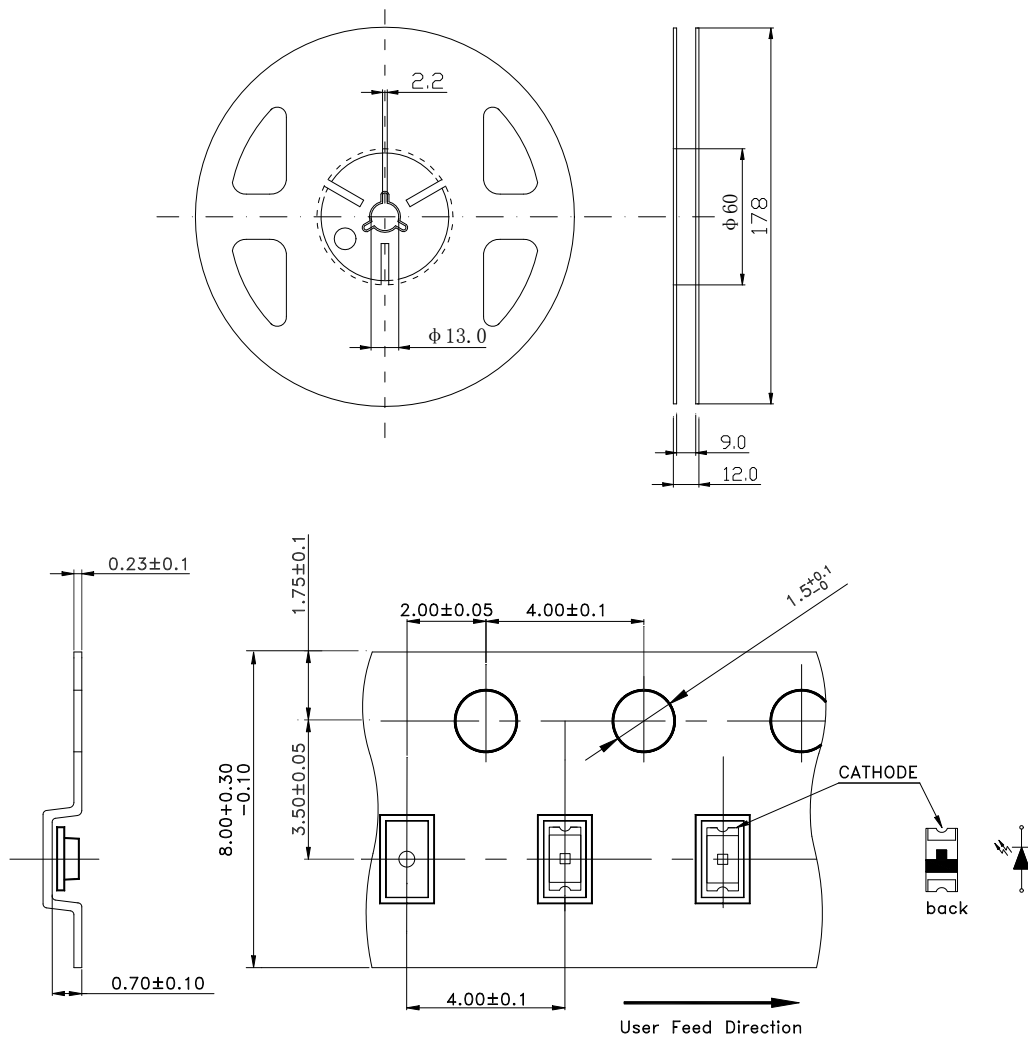

注/ Notes: 1. 尺寸单位为毫米(mm)/ All dimensions are in millimeters.

2. 无特别说明尺寸公差是±0.1mm/ Tolerance is ± 0.1 mm unless otherwise noted.





9、圆盘及载带卷出方向及空穴规格/ Tape Leader & Trailer Dimensions And Reel:

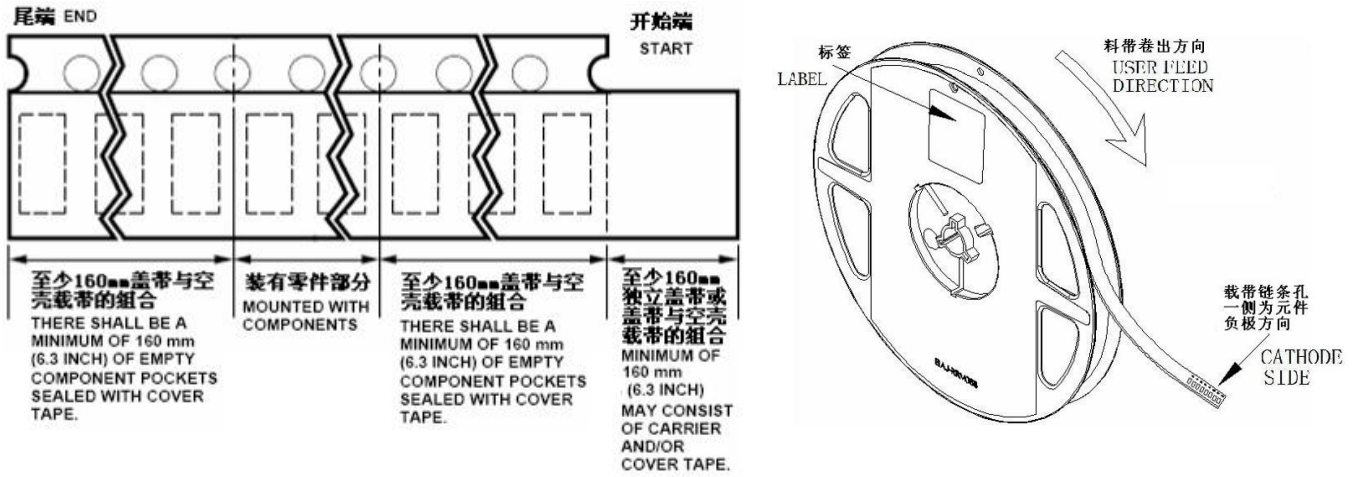

10、包装/ Packaging:

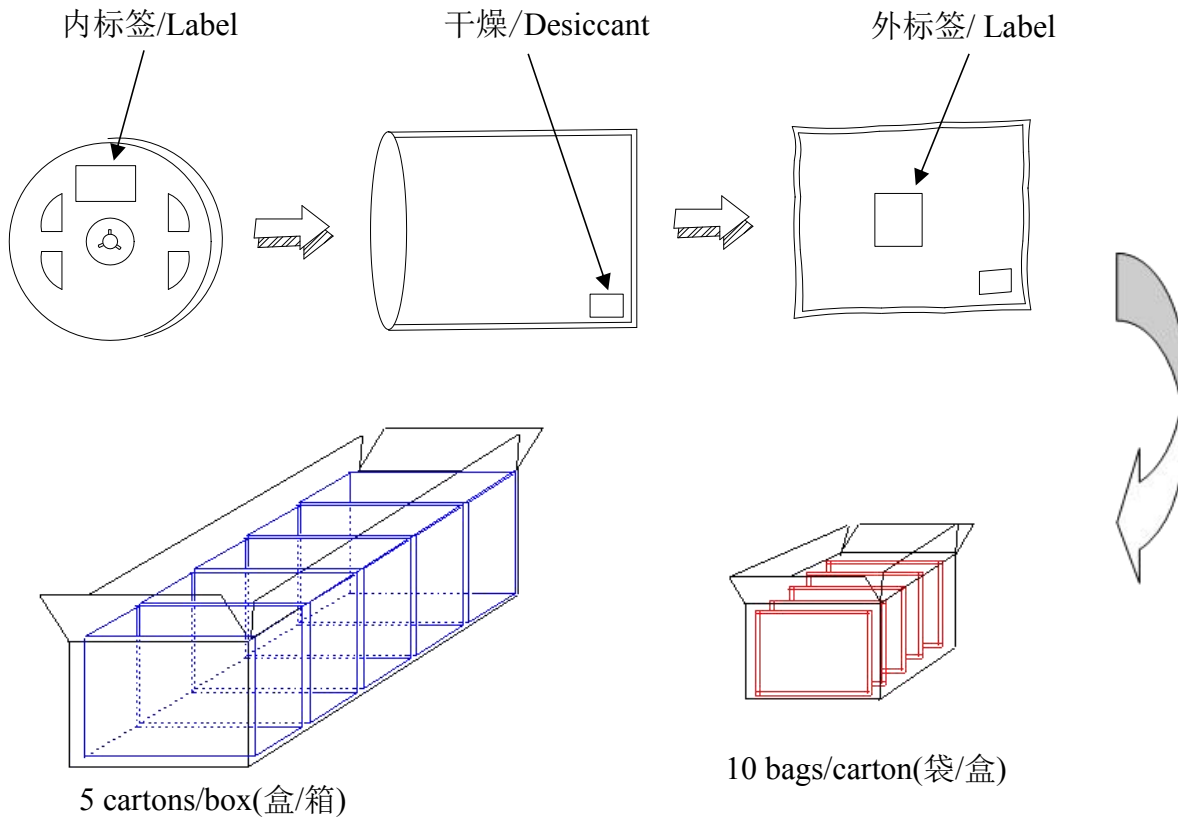



11、信赖度测试/ Reliability Test:

| 类别<br>Classification    | 测试项目<br>Test Item                                 | 测试环境<br>Test Condition   | 测试时间<br>Reference Standard     | 参考标准<br>Reference Standard  |
|-------------------------|---|--|--------------------------------|---|
| 耐久性测试<br>Endurance Test | 工作寿命<br>Operation Life                            | 室温条件下以最大额定电流持续点亮; 以25mA 测试。<br>Ta= Under Room Temperature As Per Data Sheet Maximum Rating                   | 1000 HRS<br>(-24 HRS, +72 HRS) | MIL-STD-750D:1026<br>MIL-STD-883D:1005<br>JIS C 7021:B-1                      |
|                         | 高温高湿储存<br>High Temperature, High Humidity Storage | IR-Reflow In-Board, 2 Times<br>环境温度Ta= 85±5℃,相对湿度RH= 85%<br>IR-Reflow In-Board, 2 Times<br>Ta= 85±5℃,RH= 85% | 1000 HRS<br>(± 2 HRS)          | JESD22-A101   |
|                         | 高温储存<br>High Temperature Storage                  | 环境温度Ta= 105±5℃   | 1000 HRS<br>(-24HRS, +72 HRS)  | MIL-STD-883D:1008<br>JIS C 7021:B-10  |
|                         | 低温储存<br>Low Temperature Storage                   | 环境温度 Ta= -40±5℃  | 1000 HRS<br>(-24HRS, +72 HRS)  | JIS C 7021:B-12   |
| 环境测试                    | 温度循环<br>Temperature Cycling                       | 100℃ ~ 25℃ ~ -40℃ ~ 25℃<br>30mins 5mins 30mins 5mins   | 100 次循环/ Cycles                | MIL-STD-202F:107D<br>MIL-STD-750D:1051<br>MIL-STD-883D:1010<br>JIS C 7021:A-4 |
|                         | 冷热冲击<br>Thermal Shock                             | IR-Reflow In-Board, 2 Times<br>100 ± 5℃ ~ -40℃ ± 5℃<br>10mins 10mins   | 100 次循环/ Cycles                | MIL-STD-202F:107D<br>MIL-STD-750D:1051<br>MIL-STD-883D:1011                   |
|                         | 回流焊 无铅制程<br>Reflow Pb Free Process                | 温度最高 260℃ 时间: 最大 10 秒<br>Peak temperature range 260℃ 10s max   | -----                          | MIL-STD-750D:2031.2<br>J-STD-020C   |

失效判定标准 Criteria For Judging Damage

| 项目<br>Test items        | 符号<br>Symbol | 测试条件<br>Test Condition | 判定标准<br>Criteria For Judgement |                |
|-------------------------|--------------|------------------------|--------------------------------|----------------|
|                         |              |                        | 最大                             | Max            |
| 正向电压<br>Forward Voltage | VF           | IF=5mA                 |                                | U. S. L) x1. 1 |
| 漏电流<br>Reverse Current  | IR           | VR=5V                  |                                | U. S. L) x2. 0 |
| 光通量<br>Luminous Flux    | mcd          | IF=5mA                 | L. S. L) x0. 7                 |                |

U. S. L: Upper standard level 规格上限 L. S. L: Lower standard level 规格下限

备注/ Note:

信赖性测试基于宏齐光现有的测试平台

The Reliability tests are based on HARVATEK existing test platform.



## 12、注意事项/ Cautions:

### 使用/ Application:

1. LED 是电流驱动元件, 电压的细微变化会产生较大的电流波动, 导致元件遭到破坏。客户应使用电阻串联作限流保护。

A LED is a current-operated device. The slight shift of voltage will cause big change of current, which will damage LEDs. Customer should use resistors in series for the Over-Current-Proof

2. 为了确保多颗 LED 并联使用时光色一致, 建议每条支路使用单独电阻, 如下图模式 A 所示;

如采用下图模式 B 所示电路, LED 光色可能因每一颗 LED 不同的伏安特性而造成光色差异。

In order to ensure intensity uniformity on multiple LEDs connected in parallel in an application, it is recommended to use individual resistor separately, as shown in Circuit A below. The brightness of each LED shown in Circuit B might appear difference due to the differences in the I-V characteristics of those LEDs.

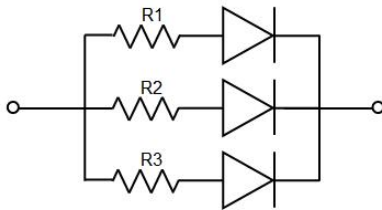

电路模式/ Circuit model A

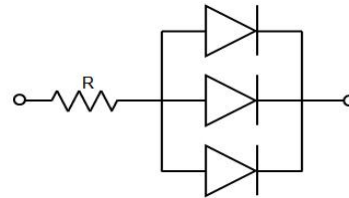

电路模式/ Circuit model B

3. 过高的环境温度会影响 LED 的亮度以及其他性能, 所以为使 LED 有较好的性能表现应远离热源

High temperature may reduce LEDs' intensity and other performances, so keeping it away from heat source to get good performance is necessary.

4. 光电参数公差/ Rank Tolerance:

正向电压 REF / VF:  $\pm 0.02V$

亮度 CAT / IV:  $\pm 10\%$

色度坐标 X / Y:  $\pm 0.005$

### 存储/ Storage:

1. 未打开原始包装的情况下, 建议储存的环境为: 温度:  $5^{\circ}C \sim 30^{\circ}C$ ; 湿度: 85%RH 以下。当库存超过两个月, 使用前应做除湿处理, 条件  $60^{\circ}C/8$  小时。

Before opening original package, it is recommended to store them in the following environment:

Temperature:  $5^{\circ}C \sim 30^{\circ}C$ , Humidity: 85%RH max. When the inventory over 3 months, Should be done before treatment using dehumidification, Temperature:  $60^{\circ}C/8$  hours.

2. 打开原始包装后, 建议储存环境为: 温度  $5 \sim 30^{\circ}C$ ; 湿度 60% 以下。

After opening original package, the storage ambient for the LEDs should be in  $5 \sim 30^{\circ}C$  temperature and 60% or less relative humidity

3. LED 是湿度敏感元件, 为避免元件吸湿, 建议打开包装后, 将其储存在有干燥剂的密闭容器内, 或者储存在氮气防潮柜内。



In order to avoid moisture absorption, it is recommended that the LEDs that out of the original package should be stored in a sealed container with appropriate desiccant, or in desiccators with nitrogen ambient.

4. 打开包装后, 元件应该在 168 小时 (7 天) 使用; 且贴片后应尽快做焊接。

The LEDs should be used within 168hrs (7days) after opening the package. Once been mounted, soldering should be quick.

5. 如果干燥剂失效或者元件暴露于空气中超过 168 小时 (7 天), 应作除湿处理。烘烤条件: 60°C , 24 小时。

If the moisture absorbent material (silica gel) has faded away or the LEDs stored out of original package for more than 168hrs (7 days), baking treatment should be performed using the conditions: 60°C at least 24 hours.

## ESD 静电防护/ ESD (Electrostatic Discharge)-Protection

LED (特别是 InGaN 结构的蓝色、翠绿色、紫色、白色、粉红色 LED) 是静电敏感元件, 静电或者电流过载会。LED 结构。LED 受到静电伤害或电流过载可能会导致性能异常, 比如漏电流过大, VF 变低, 或者无法点亮等等。所以请注意以下事项:

A LED (especially the Blue、White and Green product) is an ESD sensitive component, and static electricity or power surge will damage the LED. ESD-damaged LEDs will exhibit abnormal characteristics such as high reverse leakage current, low forward voltage, or “no light-up” at low currents, etc. Some advice as below should be noticed:

1. 接触 LED 时应佩戴防静电腕带或者防静电手套。

A conductive wrist strap or anti-electrostatic glove should be worn when handling these LEDs

2. 所有的机器设备、工制具、工作桌、料架等等, 应该做适当的接地保护 (接地阻抗值 10Ω 以内)。

All devices, equipment, machinery, work tables and storage racks, etc. must be properly grounded (Grounding impedance value within 10Ω)

3. 储存或搬运 LED 应使用防静电料袋、防静电盒以及防静电周转箱, 严禁使用普通塑料制品。

Use anti-static package or boxes to carry and storage LEDs. And ordinary plastic package or boxes is forbidden to use.

4. 建议在作业过程中, 使用离子风扇来压制静电的产生。

Use ionizer to neutralize the static charge during handling or operating.

5. 距离 LED 元件 1 英尺距离的环境范围内静电场电压小于 100V。

All surfaces and objects within 1 ft close to LEDs measure less than 100V.

## 清洗/ Cleaning

建议使用异丙醇等醇类溶液清洗 LED, 严禁使用腐蚀性溶液清洗。

Use alcohol-based cleaning solvents such as IPA (isopropyl alcohol) to clean LEDs if necessary

## 焊接 / Soldering

1. 回流焊焊接条件参考第二页温度曲线。

Soldering condition refer to the draft “Soldering Profile Suggested” on page 2.

2. 回流焊焊接次数不得超过两次。

Reflow soldering should not be done more than 2 times.

3. 只建议在修理和重工的情况下使用手工焊接; 最高焊接温度不应超过 300 度, 且须在 3 秒内完成。烙铁最大功率应不超过 30W。

Manual soldering is only suggested on repair and rework. The maximum soldering temperature should not exceed 300°C



within 3 sec. And the maximum capacity of soldering iron is 30W in power.

4.焊接过程中,严禁在高温情况下碰触胶体。

During the soldering process, do not touch the lens at high temperature.

5.焊接后,禁止对胶体施加外力,禁止弯折 PCB,避免元件受到撞击。

After soldering, any mechanical force on the lens or any excessive vibration shall not be accepted to apply, also the circuit board shall not be bent as well.

### 其他/ Others

1. 本规格所描述的 LED 定义应用在普通的电子设备范围(例如办公设备、通讯设备等等)。如果有更为严苛的信赖度要求,特别是当元件失效或故障时可能会直接危害到生命和健康时(如航天、运输、交通、医疗器械、安全保护等等),请事先知会敝司业务人员。

The LEDs described here are intended to be used for ordinary electronic equipment (such as office equipment, communication equipment and household applications). Consult Harvatek's Sales in advance for the applications in which exceptional reliability is required, particularly when the failure or malfunction of the LEDs may directly jeopardize life or health. (such as in aviation, transportation, traffic control equipment, medical and life support systems and safety devices).

2. 高亮度 LED 产品点亮时可能会对人眼造成伤害,应避免从正上方直视。

The light output from the high luminous intensity LEDs may cause injury to human eyes when viewed directly.

3. 出于持续改善的目的,产品外观和参数规格可能会在没有预先通知的情况下作改良性变化。

The appearance and specifications of the product may be modified for improvement without prior notice.