

Table of length tolerances/ Tablica tolerancji dlugosci mm

Over/Od	Up to and including/ Do-wlacznie	Tolerance/Tolerancja
100	1000	±20
1000	3000	±30
3000	5000	±40
5000	10000	±50
10000	15000	±100
15000	20000	±150
20000		±L/100

8±1 CYNOWAC TINNED

UWAGI:  
1. DLUGOSC PATRZ ARKUSZ 2.

NOTES:  
1. LENGHT SEE SHEET 2.

SCHEMATY POLACZEN/WIRING CONFIGURATION

UWAGA: Uziemienie na schematach tylko dla numerow E392XXXXXXXXXXXX lub E396XXXXXXXXXXXX.  
NOTE: GROUND SHOWN ON WIRING CONFIGURATIONS FOR E392XXXXXXXXXXXX OR E396XXXXXXXXXXXX ONLY.

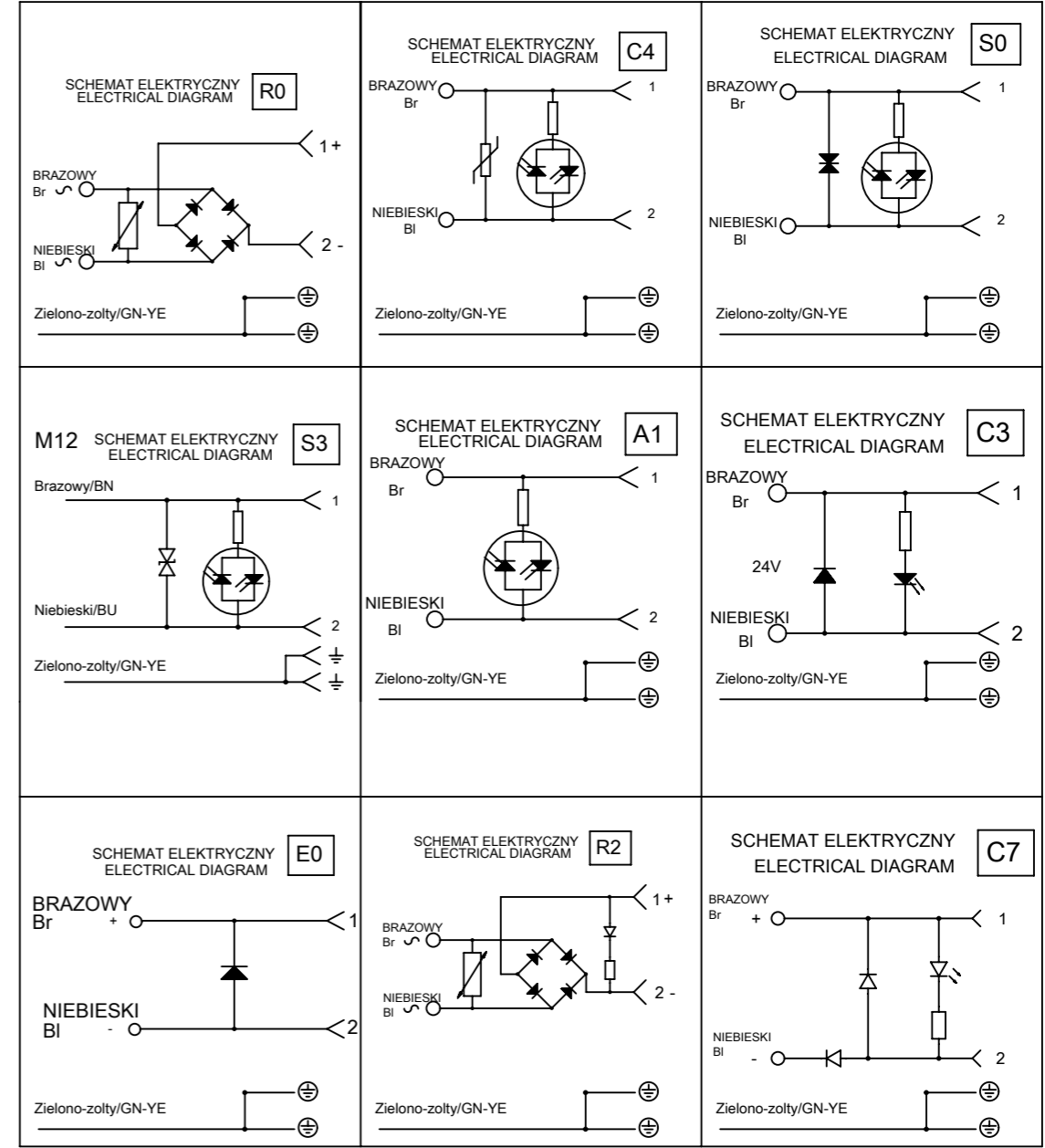

THIS DRAWING CONTAINS INFORMATION THAT IS PROPRIETARY TO MOLEX ELECTRONIC TECHNOLOGIES, LLC AND SHOULD NOT BE USED WITHOUT WRITTEN PERMISSION

DIMENSION UNITS <b>mm</b>	SCALE <b>NTS</b>	CURRENT REV DESC: OBSOLETE PART NUMBER		<b>molex</b>		
GENERAL TOLERANCES (UNLESS SPECIFIED)		EC NO: 641324				
		DRWN: AKUMAR19 2020/06/29		PRODUCT CUSTOMER DRAWING		
		CHK'D: GGA 2020/08/27		DOCUMENT NUMBER		
		APPR: GGA 2020/08/27		E39XXXXXXXXXXXX		
		INITIAL REVISION:		DOC TYPE DOC PART REVISION		
		DRWN: MLEVYTSKY 2009/01/22		PSD 001 B		
		APPR: MWOLSZCZAK 2009/01/22		MATERIAL NUMBER		
		DRAFT WHERE APPLICABLE MUST REMAIN WITHIN DIMENSIONS		CUSTOMER		
		THIRD ANGLE PROJECTION		GENERAL MARKET		
		DRAWING		SHEET NUMBER		
		SERIES		1 OF 4		
		A3-SIZE 121050				

E 3 9 X X X X X X X X X X X X X

E - Pakowanie bez workow  
 W - Pakowanie pojedynczo  
 Q - Szybkie pakowanie

ILOSC PRZEWODOW/NUMBER OF WIRES:  
 1=2 PRZEWODY,  
 2 lub 6=2 PRZEWODY+UZIEMIENIE,  
 3=3 PRZEWODY+UZIEMIENIE.

TYP KABLA/CABLE TYPE  
 PATRZ TABELA 1/SEE TABLE 1

RODZAJ KABLA/CABLE CROSS SECTION AREA  
 PATRZ TABELA 2/SEE TABLE 2

KOLOR MOULDINGU/HEAD COLOUR:  
 G=SZARY/GREY;  
 N=CZARNY/BLACK;  
 T=PRZEZROCZYSTY/TRANSPARENT;  
 A=CZARNY/BLACK;  
 B=SZARY/GREY.

DLUGOSC KABLA W CM/CABLE LENGHT IN CM  
 NP:050=50 CM, 300=300 CM.

POLOZENIE PINU Z UZIEMIENIEM/EARTH PIN LOCATION:  
 1=PODWOJNE UZIEMIENIE NA GODZINIE 6 ORAZ 12/DOUBLE EARTH ON 6H AND 12H,  
 2=UZIEMIENIE NA GODZINIE 12/1EARTH ON 12H,  
 6=UZIEMIENIE NA GODZINIE 6/EARTH ON 6H.

GASKET ORAZ SRUBY/GASKET SCREWS:  
 1=GASKET PROFILOWANY+SRUBA/NBR PROFILE GASKET+FIXING SCREWS,  
 2=NBR PLASKI GASKET+SRUBA/NBR FLAT GASKET+SCREW,  
 3=SILIKONOWY PROFILOWANY GASKET+SRUBA/SILICONE PROFILE GASKET+SCREW,  
 4=SILIKOWANY PLASKI GASKET+SRUBA/SILICON FLAT GASKET+SCREW,  
 P=ZINTEGROWANY GASKET+SRUBA/INTEGRATED GASKET+FIXING SCREW,  
 R=ZINTEGROWANY GASKET+SRUBA/INTAGRATED GASKET+SCREW,  
 T=PROFILOWANY GASKET+SRUBA, PROFILE GASKET+SCREW.

RODZAJ POLACZENIA/INTERNAL CIRCUIT  
 PATRZ SCHEMATY POLACZEN/WIREING CONFIGURATION

NAPIECIE ORAZ KOLOR DIODY/VOLTAGE AND LED COLOUR:

1= 12V	} CZERWONA DIODA RED LED	A= 12V	} ZIELONA DIODA GREEN LED	G= 12V	} ZOLTA DIODA YELLOW LED
2= 24V		B= 24V		H= 24V	
3= 48V		C= 48V		K= 48V	
4= 115V		D= 115V		L= 115V	
5= 230V		E= 230V		M= 230V	

THIS DRAWING CONTAINS INFORMATION THAT IS PROPRIETARY TO MOLEX ELECTRONIC TECHNOLOGIES, LLC AND SHOULD NOT BE USED WITHOUT WRITTEN PERMISSION											
DIMENSION UNITS		SCALE		CURRENT REV DESC: OBSOLETE PART NUMBER						<b>molex</b>	
mm		NTS									
GENERAL TOLERANCES (UNLESS SPECIFIED)				EC NO: 641324		DRWN: AKUMAR19		2020/06/29		MPM E39XXXXXXXXXXXX	
				CHK'D: GGA		2020/08/27					
				APPR: GGA		2020/08/27		PRODUCT CUSTOMER DRAWING			
				INITIAL REVISION:		DRWN: MLEVYTSKY		2009/01/22		DOCUMENT NUMBER	
				APPR: MWOLSZCZAK		2009/01/22		E39XXXXXXXXXXXX		DOC TYPE DOC PART REVISION	
				ANGULAR TOL						PSD 001 B	
DRAFT WHERE APPLICABLE MUST REMAIN WITHIN DIMENSIONS				THIRD ANGLE PROJECTION		DRAWING		SERIES		MATERIAL NUMBER CUSTOMER SHEET NUMBER	
						A3-SIZE		121050		SEE TABLE GENERAL MARKET 2 OF 4	

TABELA 2 KABLE/TABLE 2 CABLES

TABELA 2 KABLE/TABLE 2 CABLES

MOLEX PN	mPm	Code	PRZEW	PRZEKROJ	MATERIAL	KOLOR/COLOUR	SREDNICA Ø	DIN A-B	DIN C
1210180080	I	0	3	1 mm2	PVC CEI 2022 II O.R.	Szary/Grey RAL7035	-	-	-
1210180467	A	2	2	20 AWG	PVC CSA/UL 2661	Czarny/Black	5,5+/-0,2 mm	OK.	OK.
-	A	2	3	20 AWG	PVC CSA/UL 2661	Czarny/Black	5,6+/-0,2 mm	OK.	OK.
1210180394	A	2	4	20 AWG	PVC CSA/UL 2661	Czarny/Black	6,2+/-0,2 mm	OK.	OK.
-	A	2	5	20 AWG	PVC CSA/UL 2661	Czarny/Black	7+/-0,2 mm	OK.	
1210180297	B	2	2	20 AWG	PUR CSA/UL 20668	Czarny/Black	5,5+/-0,2 mm	OK.	OK.
1210180126	B	2	3	20 AWG	PUR CSA/UL 20668	Czarny/Black	5,6+/-0,2 mm	OK.	OK.
1210180387	B	2	4	20 AWG	PUR CSA/UL 20668	Czarny/Black	6,2+/-0,2 mm	OK.	OK.
-	B	2	5	20 AWG	PUR CSA/UL 20668	Czarny/Black	7+/-0,2 mm	OK.	
1210180122	D	2	3	0,5 mm2	PVC TI2 CEI 20-20	Szary/Grey	-	-	-
-	F	2	3	0,5 mm2	CNOMO	Szary/Grey RAL7000	5,5+/-0,2 mm	OK.	OK.
1210180047	I	2	2	0,5 mm2	PVC CEI 2022 II O.R.	Szary/Grey RAL7035	5,5+/-0,2 mm	OK.	OK.
-	I	2	3	0,5 mm2	PVC CEI 2022 II O.R.	Szary/Grey RAL7035	5,5+/-0,2 mm	OK.	OK.
1210180146	I	2	4	0,5 mm2	PVC CEI 2022 II O.R.	Szary/Grey RAL7035	6,5+/-0,2 mm	OK.	
1210180177	I	2	5	0,5 mm2	PVC CEI 2022 II O.R.	Szary/Grey RAL7035	7+/-0,2 mm	OK.	
1210180022	N	2	2	0,5 mm2	PVCH03	Czarny/Black	5,1+ 0,2-0 mm	OK.	OK.
1210180064	N	2	3	0,5 mm2	PVCH03	Czarny/Black	5,4+ 0,2-0 mm	OK.	OK.
1210180153	N	2	4	0,5 mm2	PVCH03	Czarny/Black	5,75+0,2-0 mm	OK.	OK.
1210180046	P	2	2	0,5 mm2	PUR - BLEND	Czarny/Black	5,5+/-0,2 mm	OK.	OK.
-	P	2	3	0,5 mm2	PUR - BLEND	Czarny/Black	5,5+/-0,2 mm	OK.	OK.
1210180302	P	2	4	0,5 mm2	PUR - BLEND	Czarny/Black	-	-	-
-	P	2	5	0,5 mm2	PUR - BLEND	Czarny/Black	7+/-0,2 mm	OK.	OK.
1210180409	A	3	2	18 AWG	PVC CSA/UL 2661	Czarny/Black	6,5+/-0,2 mm	OK.	
1210180129	A	3	3	18 AWG	PVC CSA/UL 2661	Czarny/Black	6,5+/-0,2 mm	OK.	
1210180159	A	3	4	18 AWG	PVC CSA/UL 2661	Czarny/Black	7+/-0,2 mm	OK.	
-	A	3	5	18 AWG	PVC CSA/UL 2661	Czarny/Black	7,8+/-0,2 mm	OK.	
1210180351	B	3	2	18 AWG	PUR CSA/UL 20668	Czarny/Black	6,5+/-0,2 mm	OK.	
1210180127	B	3	3	18 AWG	PUR CSA/UL 20668	Czarny/Black	6,5+/-0,2 mm	OK.	
1210180127	B	3	4	18 AWG	PUR CSA/UL 20668	Czarny/Black	7+/-0,2 mm	OK.	
-	B	3	5	18 AWG	PUR CSA/UL 20668	Czarny/Black	7,8+/-0,2 mm	OK.	
1210180073	D	3	3	0,75 mm2	PVC TI2 CEI 20-20	Szary/Grey	-	-	-
1210180145	D	3	4	0,75 mm2	PVC TI2 CEI 20-20	Szary/Grey	-	-	-
1210180120	I	3	3	0,75 mm2	PVC CEI 2022 II O.R.	Szary/Grey RAL7035	-	-	-
1210180143	I	3	4	0,75 mm2	PVC CEI 2022 II O.R.	Szary/Grey RAL7035	-	-	-
1210180032	N	3	2	0,75 mm2	PVCH05	Czarny/Black	6,2+ 0,2-0 mm	OK.	
1210180069	N	3	3	0,75 mm2	PVCH05	Czarny/Black	6,6+0,2-0 mm	OK.	
-	N	3	4	0,75 mm2	PVCH05	Czarny/Black	7,15+0,2-0 mm	OK.	
1210180174	N	3	5	0,75 mm2	PVCH05	Czarny/Black	8,0+0,2-0 mm	OK.	
-	P	3	2	0,75 mm2	PUR - BLEND	Czarny/Black	6,5+/-0,2 mm	OK.	

MOLEX PN	mPm	Code	PRZEW	PRZEKROJ	MATERIAL	KOLOR/COLOUR	SREDNICA Ø	DIN A-B	DIN C
1210180071	P	3	3	0,75 mm2	PUR - BLEND	Czarny/Black	6,5+/-0,2 mm	OK.	
1210180152	P	3	4	0,75 mm2	PUR - BLEND	Czarny/Black	7+/-0,2 mm	OK.	
1210180384	R	3	3	0,75 mm2	TPR HAL. FREE	Czarny/Black	6,5+/-0,2 mm	OK.	
1210180094	T	3	3	0,75 mm2	PUR CSA/UL	Żółty/Yellow	-	-	-
1210180309	Y	3	3	0,75 mm2	SIL/0300	Czerwony/Red	6,5+/-0,2 mm	-	-
1210180081	F	4	3	1 mm2	CNOMO	Szary/Grey RAL7000	-	-	-
-	F	4	4	1 mm2	CNOMO	Szary/Grey RAL7000	7,1+0,2-0 mm	OK.	
1210180042	I	4	2	1 mm2	PVC CEI 2022 II O.R.	Szary/Grey RAL7035	7,1+0,2-0 mm	OK.	
1210180079	I	4	3	1 mm2	PVC CEI 2022 II O.R.	Szary/Grey RAL7035	7,1+0,2-0 mm	OK.	
1210180036	N	4	2	1 mm2	PVCH05	Czarny/Black	6,5+0,2-0 mm	OK.	
1210180082	N	4	3	1 mm2	PVCH05	Czarny/Black	6,9+0,2-0 mm	OK.	
1210180117	R	4	3	1 mm2	TPR HAL. FREE	Czarny/Black	-	-	-
1210180085	N	5	3	1,5 mm2	PVCH05	Czarny/Black	8,3+0,2-0 mm	OK.	
1210180313	I	6	2	0,35 mm2	PVC CEI 2022 II O.R.	Szary/Grey RAL7035	-	-	-
-	A	7	3	20 AWG	PVC CSA/UL 2661	Żółty/Yellow	5,6+/-0,2 mm	OK.	OK.
1210180149	I	9	4	0,75 mm2	PVC CEI 2022 II O.R.	Szary/Grey RAL7035	-	-	-

TABELA 1 TYPY KABLI/TABLE 1 CABLES TYPE

Znakowanie	Rodzaje kabla	Właściwości	Przekroje
/Code	/Cable types	/Features	/Stranding
N	PVC	Kabel z dobrą rezystancją w wodzie ale słabą w oleju./Application general purpose cable which has good resistance to water, but usually poor oil resistance.	0.5 mm2 = 15 x 0.20 0.75 mm2 = 21 x 0.20 1 mm2 = 28 x 0.20
I	PVC	Zatwierdzone przez IEC 332-2A, samogaszący./Approved to IEC 332-2A, flame retardant and self extinguishing. Limited resistant to mineral oils.	0.5 mm2 = 28 x 0.15 0.75 mm2 = 42 x 0.15 1 mm2 = 32 x 0.20
P	PVC	Dobra rezystancja w olejach i chemikaljach./Offer good resistance to oil and chemicals. Can swell when constantly immersed in water.	0.5 mm2 = 28 x 0.15 0.75 mm2 = 42 x 0.15 1 mm2 = 32 x 0.20
A	PVC	Zatwierdzony porzez CSA-UL 2661.Dobra rezystancja na wode słaba na olej./ Approved to CSA-UL 2661, application general purpose cable which has good resistance to water, but usually poor oil resistance.	20 AWG = 32 x 0.15 18 AWG = 52 x 0.15
B	PVC	Zatwierdzony przez CSA-UL 20668, bardzo dobra rezystancja w oleju i chemikaljach./ Approved to CSA-UL 20668, very good resistance to oil and chemicals.	20 AWG = 32 x 0.15 18 AWG = 52 x 0.15

THIS DRAWING CONTAINS INFORMATION THAT IS PROPRIETARY TO MOLEX ELECTRONIC TECHNOLOGIES, LLC AND SHOULD NOT BE USED WITHOUT WRITTEN PERMISSION

SCALE: mm NTS

GENERAL TOLERANCES (UNLESS SPECIFIED)

	MM	INCH
4 PLACES	±	±
3 PLACES	±	±
2 PLACES	±	±
1 PLACE	±	±
0 PLACES	±	±

ANGULAR TOL ± °

DRAFT WHERE APPLICABLE MUST REMAIN WITHIN DIMENSIONS

THIRD ANGLE PROJECTION

DRAWING: A3-SIZE

SERIES: 121050

MATERIAL NUMBER: SEE TABLE

CUSTOMER: GENERAL MARKET

SHEET NUMBER: 3 OF 4

EC NO: 641324  
DRWN: AKUMAR19 2020/06/29  
CHK'D: GGA 2020/08/27  
APPR: GGA 2020/08/27

INITIAL REVISION:  
DRWN: MLEVYTSKYY 2009/01/22  
APPR: MWOLSZCZAK 2009/01/22

PRODUCT CUSTOMER DRAWING

DOCUMENT NUMBER: E39XXXXXXXXXXXXX

DOC TYPE: PSD | DOC PART: 001 | REVISION: B

**molex**

MPM E39XXXXXXXXXXXXX

TABELA 3/CHART 3

Molex PN	Woodhead PN	Molex PN	Woodhead PN	Molex PN	Woodhead PN
1210502657	E391A2A10011E05	1210502663	E392N2N06011C4H	1210500225	E392N2N50021C4B
1210502315	E391IAN03011C4H	1210500076	E392N2N10011C4H	1210500226	E392N2N50021C4D
1210502342	E392A2A06011C4H	1210500083	E392N2N10012C4L	1210500229	E392N2N50061C4B
1210502268	E392A2A20011S0H	1210502269	E392N2N10K11C4H	1210501987	E392P2N11011C4H
1210500022	E392A2A30011C4H	1210500102	E392N2N10K21C4B	1210500238	E392P2N30011C4H
1210502610	E392A2A50011S0H	1210500104	E392N2N10K61C4B	1210502573	E396N2N10011C4H
1210502645	E392B2A10K11C4H	1210500126	E392N2N20011A1H	1210502674	E392I2N20012S12
1210501803	E392B2A50011C4H	1210500129	E392N2N20011C42	1210502655	E392N2N30011A1H
1210501660	E392I2N10011C4H	1210500139	E392N2N20014C43	1210502693	W392N2N20011C4D
1210500033	E392I2N10012A1H	1210502197	E392N2N2001TA1H	1210502928	W392A2A10K11S0H
1210502257	E392I2N10012C4H	1210500150	E392N2N20021C4B	1210502766	W392N2N20011C4B
1210500034	E392I2N10K11C4H	1210500151	E392N2N20021C4D	1210502961	W392N2N20012C42
1210501697	E392I2N20011C32	1210500157	E392N2N20061C4B	1210502761	W392N2N50011C4B
1210502630	E392I2N20011S12	1210502556	E392N2N20K11C4H	1210502802	W392N2N50011C4E
1210500043	E392I2N25011C4H	1210500170	E392N2N30011A12	1210502768	W392P2N20011C4B
1210500046	E392I2N30011C42	1210500173	E392N2N30011C42	1210502805	W392P2N50011C4B
1210500047	E392I2N30011C4H	1210500177	E392N2N30011C4H	1210502796	W392N2N20011C4E
1210500050	E392I2N36011C4H	1210502422	E392N2N30011C4L	1210502761	W392N2N50011C4B
1210500051	E392I2N50011C3H	1210500180	E392N2N30012C43	1210502978	E391N2N15011A12
1210502563	E392I2N50011C44	1210500181	E392N2N30012C4B	1210500023	E392A2A30011C4L
1210500053	E392I2N50011C4H	1210502085	E392N2N3001AC3H	1210501686	E392B2A11011C4H
1210500062	E392N2N05012E05	1210500187	E392N2N3001AC4H	1210500206	E392N2N50011C42
1210500135	E392N2N20011C4H	1210500202	E392N2N50011A12		
		1210500215	E392N2N50012C42		
		1210500220	E392N2N5001AC44		
		1210500184	E392N2N30012C4H		

THIS DRAWING CONTAINS INFORMATION THAT IS PROPRIETARY TO MOLEX ELECTRONIC TECHNOLOGIES, LLC AND SHOULD NOT BE USED WITHOUT WRITTEN PERMISSION									
DIMENSION UNITS		SCALE		CURRENT REV DESC: OBSOLETE PART NUMBER				<b>molex</b>	
mm		NTS							
GENERAL TOLERANCES (UNLESS SPECIFIED)				EC NO: 641324		2020/06/29		MPM E39XXXXXXXXXXXX	
				DRWN: AKUMAR19		2020/08/27			
				CHK'D: GGA		2020/08/27		PRODUCT CUSTOMER DRAWING	
				APPR: GGA		2020/08/27			
				INITIAL REVISION:				DOCUMENT NUMBER	
				DRWN: MLEVYTSKYY		2009/01/22			
				APPR: MWOLSZCZAK		2009/01/22		E39XXXXXXXXXXXX	
ANGULAR TOL ± °				THIRD ANGLE PROJECTION		DRAWING		SERIES	
DRAFT WHERE APPLICABLE MUST REMAIN WITHIN DIMENSIONS						A3-SIZE		121050	
				MATERIAL NUMBER		CUSTOMER		SHEET NUMBER	
				SEE TABLE		GENERAL MARKET		4 OF 4	

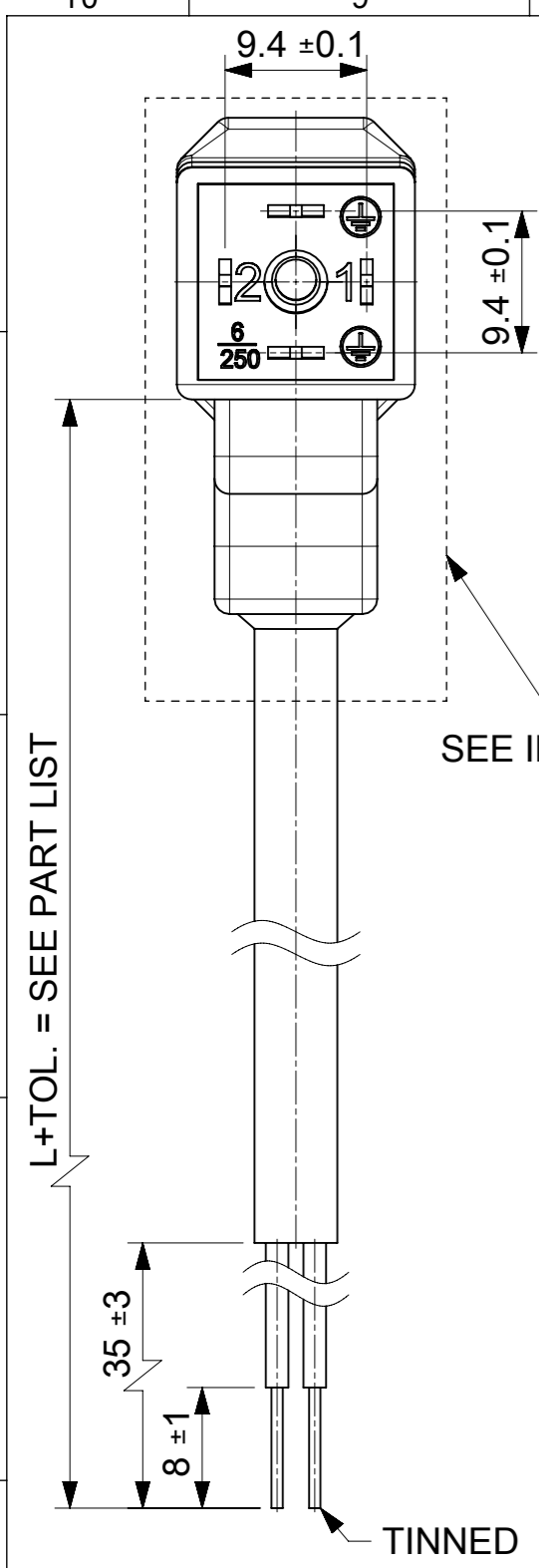

See table & PN KEY for Types of Screws and Gaskets

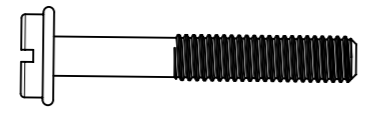

FACE VIEW  
SEE INSERT ORIENTATION

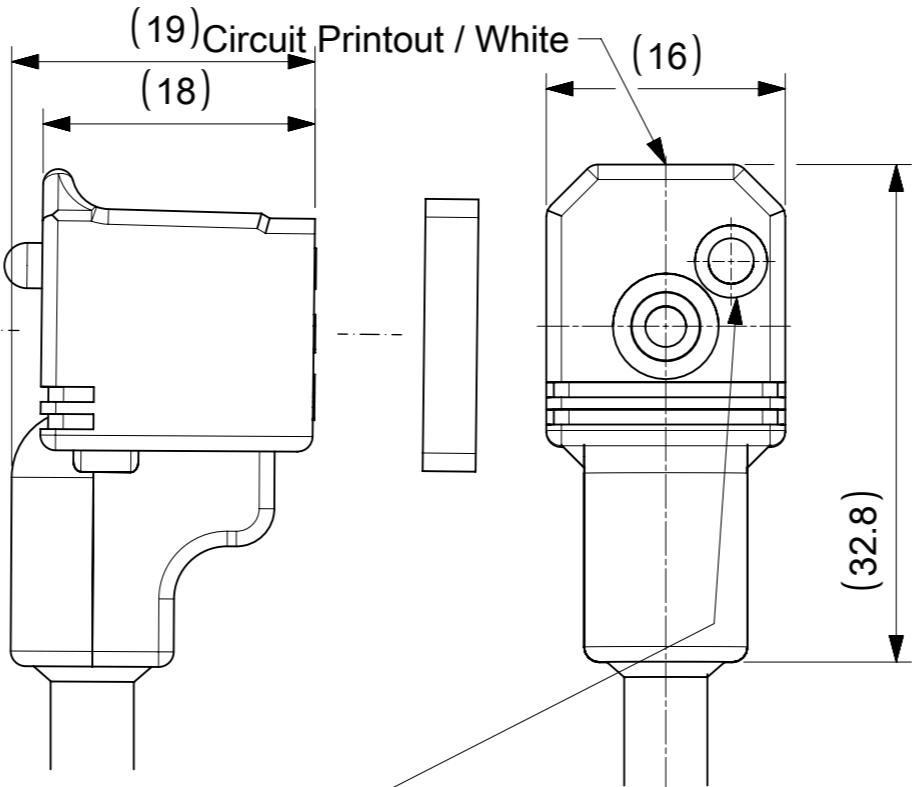

NOTE : IN THE CASE OF E0 , S1 CIRCUITS DIN CONNECTOR WITHOUT LED

INSERT ORIENTATION		
EARTH ON 6H & 12H E39XXXXXXXX1XXXX	EARTH ON 12H E39XXXXXXXX2XXXX	EARTH PIN ON 6H E39XXXXXXXX6XXXX

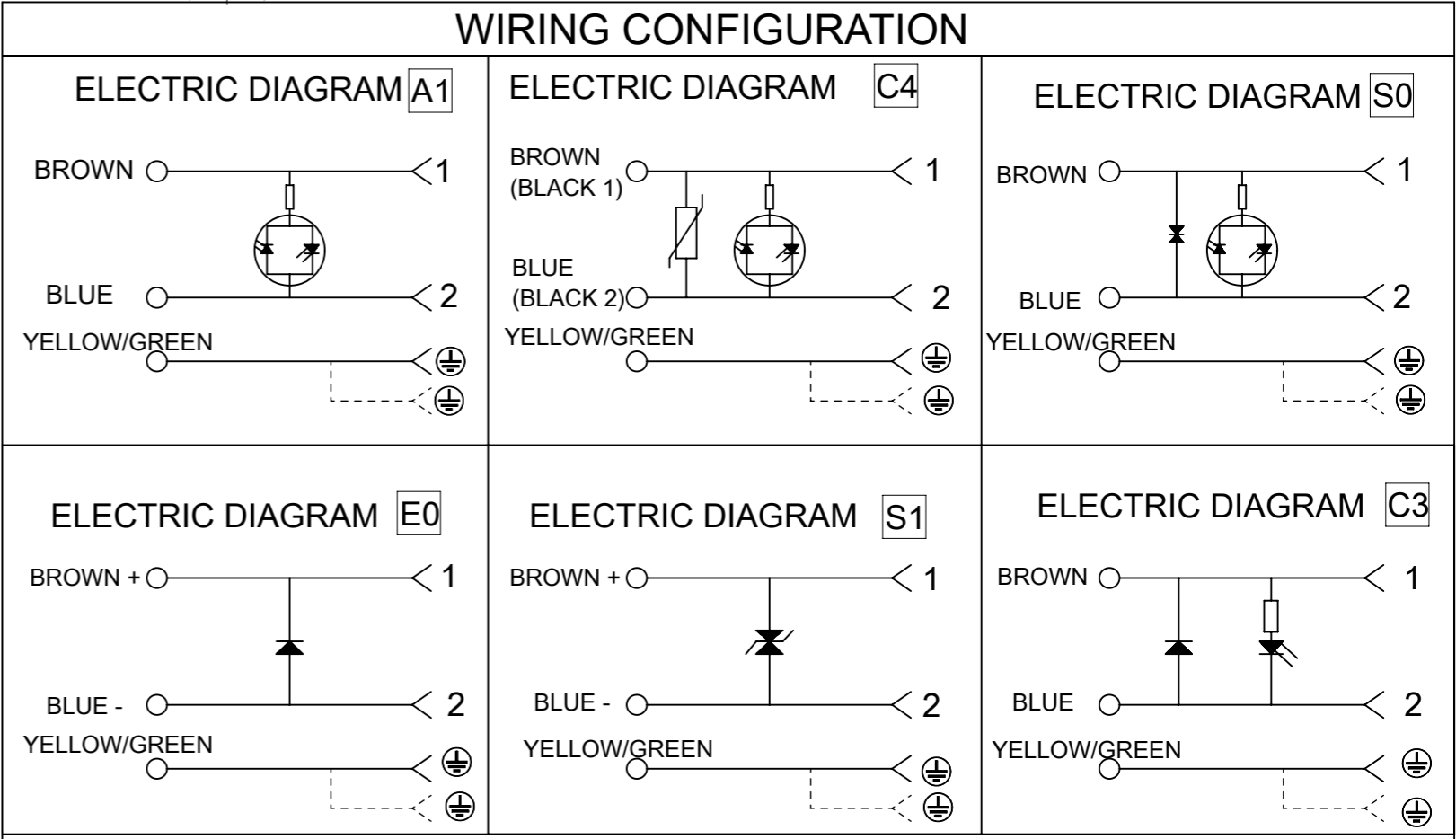

NOTE : FOR E391XXXXXXXXXXXXX CIRCUIT WITHOUT GROUND

TYPES OF SCREWS AND GASKETS		
<p>Flat Gasket</p> <p>(15.8)</p>	<p>Profiled Gasket</p> <p>(18)</p>	<p>Screw M3x20</p> <p>(20) M3</p>
		<p>Screw M3x20</p> <p>(20) M3</p>
		<p>NBR Washer</p> <p>(4)</p>

THIS DRAWING CONTAINS INFORMATION THAT IS PROPRIETARY TO MOLEX ELECTRONIC TECHNOLOGIES, LLC AND SHOULD NOT BE USED WITHOUT WRITTEN PERMISSION		CURRENT REV DESC:		<b>molex</b>	
DIMENSION UNITS	SCALE	EC NO: 723299			
mm	2:1	DRWN: APAWLAK01 2022/09/30		E39XXXXXXXXXXXXX DIN FORM MICRO	
GENERAL TOLERANCES (UNLESS SPECIFIED)		CHK'D: RSILLER 2022/09/30		PRODUCT CUSTOMER DRAWING	
ANGULAR TOL	± °	APPR: RSILLER 2022/09/30		DOCUMENT NUMBER	
4 PLACES	±	INITIAL REVISION:		SD-121050-007	
3 PLACES	±	DRWN: JMARSZALEK 2012/11/28		DOC TYPE	
2 PLACES	±	APPR: MIWASIECZKO 2013/02/12		PSD	
1 PLACE	±			DOC PART	
0 PLACES	±			001	
DRAFT WHERE APPLICABLE MUST REMAIN WITHIN DIMENSIONS		THIRD ANGLE PROJECTION	DRAWING	SERIES	MATERIAL NUMBER
			A3-SIZE	121050	SEE TABLE
					CUSTOMER
					GENERAL MARKET
					SHEET NUMBER
					1 OF 3

# PART NO MATRIX :

**E 3 9 X X X X X X X X X X X X X**

E - Packing without bag

Number of wires:  
1- 2 Wires  
2- 2 Wires + Earth  
3- 3 Wires + Earth

Cable type:  
See Cable List

Head Colour :  
G - Grey  
N - Black  
T - Transparent  
A - CSA-UL Black  
B - CSA-UL Grey

Cable Length [cm]:  
050 = 50cm  
300 = 300cm  
10K = 1000cm

Internal Circuit :  
See Wiring Configuration

Voltage and LED Color :

1 - 12V	A - 12V	G - 12V
2 - 24V	B - 24V	H - 24V
3 - 48V	C - 48V	K - 48V
4 - 115V	D - 115V	L - 115V
5 - 230V	E - 230V	M - 230V

RED LED GREEN LED YELLOW LED

Earth PIN location (see insert orientation table):  
1 = Double Earth on H6 & H12  
2 = Earth on H12  
6 = Earth on H6

Type of Gasket and Screw (see sheet 1) :  
1 = NBR Profile Gasket + Fixing Screw (M3x20mm)  
2 = NBR Flat Gasket + Fixing Screw (M3x20mm)  
3 = Silicone Profile Gasket + Fixing Screw (M3x20mm)  
4 = Silicone Profile Gasket + Screw (M3x20mm)  
T = NBR Profile Gasket + Fixing Screw with Washer (M3x20mm)

## CABLE LIST

MOLEX PN	NO. OF WIRES CODE (SEE PN MATRIX)	CABLE TYPE	NO. OF WIRES	CROSS SECTION	CABLE O.D.	CABLE JACKET	WIRES COLOR
1210180467	1	A2	2	AWG 20	∅5.4±0.2 mm	PVC BLACK	BN, BU
1210180128	2	A2	3	AWG 20	∅5.6±0.2 mm	PVC BLACK	BN, BU, GN/YE
1210180394	3	A2	4	AWG 20	∅6.2±0.25 mm	PVC BLACK	BN, BU, BK, GN/YE
1210180047	1	I2	2	0.5mm <sup>2</sup>	∅5.5+0.3 mm	PVC GREY	BN, BU
1210180284	2	I2	3	0.5mm <sup>2</sup>	∅5.5+0.3 mm	PVC GREY	BN, BU, GN/YE
1210180146	3	I2	4	0.5mm <sup>2</sup>	∅6.5+0.2 mm	PVC GREY	BN, BU, BK, GN/YE
1210180022	1	N2	2	0.5mm <sup>2</sup>	∅5.2±0.2 mm	PVC BLACK	BN, BU
1202092753	2	N2	3	0.5mm <sup>2</sup>	∅5.5±0.2 mm	PVC BLACK	BN, BU, GN/YE
1210180153	3	N2	4	0.5mm <sup>2</sup>	∅5.9±0.3 mm	PVC BLACK	BN, BU, BK, GN/YE
1202092439	2	P2	3	0.5mm <sup>2</sup>	∅5.5+0.3 mm	PUR BLACK	BN, BU, GN/YE
1210180302	3	P2	4	0.5mm <sup>2</sup>	∅6.5±0.2 mm	PUR BLACK	BN, BU, BK, GN/YE
1202094190	1	P3	2	0.75mm <sup>2</sup>	∅6.5±0.2 mm	PUR BLACK	BN, BU
1210180126	2	B2	3	AWG 20	∅5.6±0.2 mm	PUR BLACK	BN, BU, GN/YE
1210180016	1	IA	2	0.25mm <sup>2</sup>	∅3.5±0.15mm	PVC GREY	BN, BU
1202090957	2	I8	3	0.5mm <sup>2</sup>	∅5.5±0.2 mm	PVC GREY	BN, BU, GN/YE

THIS DRAWING CONTAINS INFORMATION THAT IS PROPRIETARY TO MOLEX ELECTRONIC TECHNOLOGIES, LLC AND SHOULD NOT BE USED WITHOUT WRITTEN PERMISSION

DIMENSION UNITS	SCALE	CURRENT REV DESC:		<b>molex</b>		
mm	2:1					
GENERAL TOLERANCES (UNLESS SPECIFIED)		EC NO: 723299		E39XXXXXXXXXX DIN FORM MICRO		
ANGULAR TOL	± °	DRWN: APAWLAK01 2022/09/30		PRODUCT CUSTOMER DRAWING		
4 PLACES	±	CHK'D: RSILLER 2022/09/30		DOCUMENT NUMBER		
3 PLACES	±	APPR: RSILLER 2022/09/30		SD-121050-007		
2 PLACES	±	INITIAL REVISION:		DOC TYPE DOC PART REVISION		
1 PLACE	±	DRWN: JMARSZALEK 2012/11/28		PSD 001 C2		
0 PLACES	±	APPR: MIWASIECZKO 2013/02/12		SHEET NUMBER		
DRAFT WHERE APPLICABLE MUST REMAIN WITHIN DIMENSIONS	THIRD ANGLE PROJECTION	DRAWING	SERIES	MATERIAL NUMBER	CUSTOMER	SHEET NUMBER
		A3-SIZE	121050	SEE TABLE	GENERAL MARKET	2 OF 3

PART LIST :

MOLEX PN	ENGINEERING NO.	LENGTH in MM
1210500022	E392A2A30011C4H	3000
1210500023	E392A2A30011C4L	3000
1210500033	E392I2N10012A1H	1000
1210500034	E392I2N10K11C4H	10000
1210500043	E392I2N25011C4H	2500
1210500046	E392I2N30011C42	3000
1210500047	E392I2N30011C4H	3000
1210500050	E392I2N36011C4H	3600
1210500051	E392I2N50011C3H	5000
1210500053	E392I2N50011C4H	5000
1210500062	E392N2N05012E05	500
1210500076	E392N2N10011C4H	1000
1210500078	E392N2N10012C42	1000
1210500082	E392N2N10012C4H	1000
1210500083	E392N2N10012C4L	1000
1210500102	E392N2N10K21C4B	10000
1210500104	E392N2N10K61C4B	10000
1210500126	E392N2N20011A1H	2000
1210500129	E392N2N20011C42	2000
1210500131	E392N2N20011C4B	2000
1210500135	E392N2N20011C4H	2000
1210500136	E392N2N20011S0H	2000
1210500139	E392N2N20014C43	2000
1210500150	E392N2N20021C4B	2000
1210500151	E392N2N20021C4D	2000
1210500157	E392N2N20061C4B	2000
1210500170	E392N2N30011A12	3000
1210500173	E392N2N30011C42	3000
1210500177	E392N2N30011C4H	3000
1210500180	E392N2N30012C43	3000
1210500181	E392N2N30012C4B	3000
1210500184	E392N2N30012C4H	3000
1210500185	E392N2N30012C4L	3000

MOLEX PN	ENGINEERING NO.	LENGTH in MM
1210500202	E392N2N50011A12	5000
1210500206	E392N2N50011C42	5000
1210500211	E392N2N50011C4E	5000
1210500212	E392N2N50011C4H	5000
1210500215	E392N2N50012C42	5000
1210500217	E392N2N50012C4H	5000
1210500218	E392N2N50012C4L	5000
1210500225	E392N2N50021C4B	5000
1210500226	E392N2N50021C4D	5000
1210500229	E392N2N50061C4B	5000
1210500232	E392P2N10012C4H	1000
1210500233	E392P2N10012C4L	1000
1210500236	E392P2N20011C4B	2000
1210500238	E392P2N30011C4H	3000
1210500239	E392P2N30012C4H	3000
1210500240	E392P2N30012C4L	3000
1210500243	E392P2N50012C4H	5000
1210501580	E392I2N06011C42	600
1210501660	E392I2N10011C4H	1000
1210501686	E392B2A11011C4H	1100
1210501692	E392P2N06011C4H	600
1210501697	E392I2N20011C32	2000
1210501736	E392N2N15K12C4H	15000
1210501745	E392B2A20011C4H	2000
1210501803	E392B2A50011C4H	5000
1210501987	E392P2N11011C4H	1100
1210502197	E392N2N2001TA1H	2000
1210502257	E392I2N10012C4H	1000
1210502268	E392A2A20011S0H	2000
1210502269	E392N2N10K11C4H	10000
1210502303	E392N2N05021C32	500
1210502315	E391IAN03011C4H	300
1210502342	E392A2A06011C4H	600

MOLEX PN	ENGINEERING NO.	LENGTH in MM
1210502422	E392N2N30011C4L	3000
1210502500	E392P2N10011C4H	1000
1210502556	E392N2N20K11C4H	20000
1210502563	E392I2N50011C44	5000
1210502610	E392A2A50011S0H	5000
1210502630	E392I2N20011S12	2000
1210502645	E392B2A10K11C4H	10000
1210502655	E392N2N30011A1H	3000
1210502657	E391A2A10011E05	1000
1210502663	E392N2N06011C4H	600
1210502674	E392I2N20012S12	2000
1210502978	E391N2N15011A12	1500
1210503052	E392A2A10011S0H	1000
1210503055	E392P2N03511C4H	350
1210503293	E392I2N15K11C4H	15000
1210503304	E392I2N50011C4L	5000
1210503314	E392N2N50011C4L	5000
1210503324	E392N2N10K11C45	10000
1210503349	E392P2N20011C4H	2000
1210503355	E392N2N30011C4M	3000
1210503408	E392A2A50011C4H	5000
1210503427	E392N2N10012C4M	1000
1210503437	E392P2N10011C4L	1000
1210503438	E392P2N10011C4M	1000
1210503458	E392I2N20012C42	2000
1210503459	E392I2N50012C42	5000
1210503462	E392I2N30012C45	3000
1210503472	E392N2N10011C4M	1000
1210503528	E392A2A20011C4H	2000
1210503530	E392P2N10K11S0H	10000
1210503557	E392N2N50011C45	5000
1210503592	E391N2N01512C4B	150
1210503613	E392I2N30011C426B	3000

OVER	UP TO AND INCLUDING	TOLERANCE
0	1000	±20
1000	3000	±30
3000	5000	±40
5000	10000	±50
10000	15000	±100
15000	20000	±150
20000		±L/100

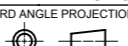
THIS DRAWING CONTAINS INFORMATION THAT IS PROPRIETARY TO MOLEX ELECTRONIC TECHNOLOGIES, LLC AND SHOULD NOT BE USED WITHOUT WRITTEN PERMISSION									
DIMENSION UNITS		SCALE		CURRENT REV DESC:					
mm		2:1							
GENERAL TOLERANCES (UNLESS SPECIFIED)				EC NO: 723299		2022/09/30		E39XXXXXXXXXXXX DIN FORM MICRO	
ANGULAR TOL ± °				DRWN: APAWLAK01		2022/09/30		PRODUCT CUSTOMER DRAWING	
4 PLACES ±				CHK'D: RSILLER		2022/09/30		DOCUMENT NUMBER	
3 PLACES ±				APPR: RSILLER		2022/09/30		SD-121050-007	
2 PLACES ±				INITIAL REVISION:		2012/11/28		DOC TYPE	
1 PLACE ±				DRWN: JMARSZALEK		2013/02/12		DOC PART	
0 PLACES ±				APPR: MIWASIECZKO				REVISION	
DRAFT WHERE APPLICABLE MUST REMAIN WITHIN DIMENSIONS				THIRD ANGLE PROJECTION		DRAWING		SHEET NUMBER	
						A3-SIZE		3 OF 3	
				SERIES		MATERIAL NUMBER		CUSTOMER	
				121050		SEE TABLE		GENERAL MARKET	