

A Series of Three- to Five-digit Digital Display Units with a Character Height of 14 mm. Models available with either red or green displays.

- Red or green displays with a character height of 14 mm are available for a variety of applications and locations.
- Miniature design with a 50-mm depth.
- Incorporating a connector, thus saving wiring effort.
- Connecting to OMRON's PLCs via dedicated PLC cables (sold separately).
- Units and minus symbols are displayed (three- and four-digit model only).
- Incorporating a zero suppression function.
- The power supply can freely change between 12 and 24 VDC.
- CE Marking. UL certification approval.



Model Number Structure

Model Number Legend

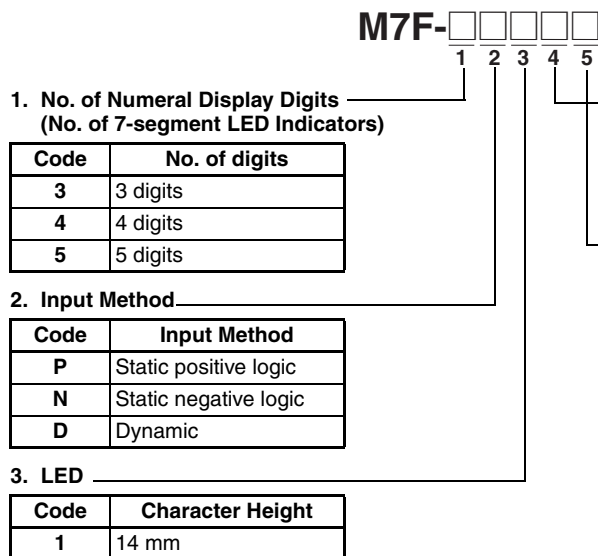

4. Display Color

Code	Color
R	Red
G	Green

5. Display Contents

Code	Display Contents
F	Numerals and minus symbol
T	Numerals and units
None	Numerals only

- Note:**
1. The input type for the five-digit model is dynamic only.
 2. Dynamic input is available with the four-digit model as well as the five-digit model.
 3. The minus symbol and units are available with three and four-digit models only.
 4. Three-digit models with numerals only are not available.

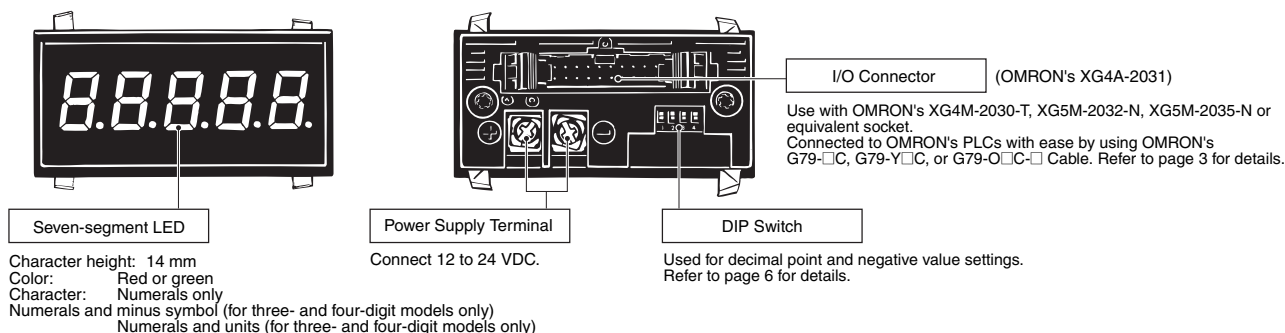

Construction and Nomenclature

Nomenclature



Ordering Information

List of Models

No. of digits	Appearance	Display color	Input method	Logic	Display contents	Model
3		Red	Static	Positive	Numerals and minus symbol	M7F-3P1RF
					Numerals and units	M7F-3P1RT*
				Negative	Numerals and minus symbol	M7F-3N1RF
			Numerals and units	M7F-3N1RT*		
		Green	Static	Positive	Numerals and minus symbol	M7F-3P1GF
					Numerals and units	M7F-3P1GT*
Negative	Numerals and minus symbol			M7F-3N1GF		
	Numerals and units	M7F-3N1GT*				
4		Red	Static	Positive	Numerals only	M7F-4P1R
					Numerals and minus symbol	M7F-4P1RF
					Numerals and units	M7F-4P1RT*
				Negative	Numerals only	M7F-4N1R
					Numerals and minus symbol	M7F-4N1RF
					Numerals and units	M7F-4N1RT*
			Dynamic	Positive	Numerals only	M7F-4D1R
					Numerals and minus symbol	M7F-4D1RF
					Numerals and units	M7F-4D1RT*
		Green	Static	Positive	Numerals only	M7F-4P1G
					Numerals and minus symbol	M7F-4P1GF
					Numerals and units	M7F-4P1GT*
				Negative	Numerals only	M7F-4N1G
					Numerals and minus symbol	M7F-4N1GF
					Numerals and units	M7F-4N1GT*
Dynamic	Positive	Numerals only	M7F-4D1G			
		Numerals and minus symbol	M7F-4D1GF			
		Numerals and units	M7F-4D1GT*			
5		Red	Dynamic	Positive	Numerals only	M7F-5D1R
		Green	Dynamic	Positive	Numerals only	M7F-5D1G

Accessories (Order Separately)

Unit Plate

- Choose the required unit plate from the following tables in order to attach it to the Unit Display Unit.
- Unit Plates are replaceable.
- Ten Unit Plates are sold as a set. (The number per set is the same for all models.)
- The characters are white.

Display contents	Single item (sheet only): 1 Set of 10 sheets
	M7F-1
	M7F-RPM-1
	M7F-PER-1
	M7F-KG-1
	M7F-MM-1
	M7F-M-1
	M7F-DOC-1
	M7F-PCS-1

Connectable PLCs

M7F model		PLC's output method		
Input	Logic input	Static output		Dynamic output
		PNP output	NPN output	
Static	Positive	○	×	×
	Negative	×	○	×
Dynamic		×	×	○

○: Connectable (See note 1.)

×: Not connectable

Note: 1. External resistance not required

2. Refer to *External Connections* on page 9 for details.

Compatibility with OMRON PLCs (Examples)

PLC Output Unit	M7F model
CS1W-OD211 C200H-OD215/218/219 C500-OD213 CQM1-OD213	M7F-□N□□
CS1W-OD212 C500-OD212	M7F-□P□□
C200H-OD215	M7F-□D□□

Cables

Use the following cables and connectors to connect the M7F to the PLC or other devices.

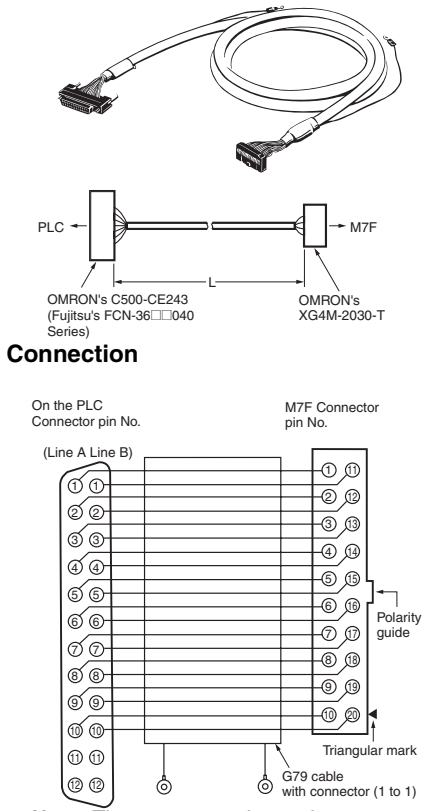
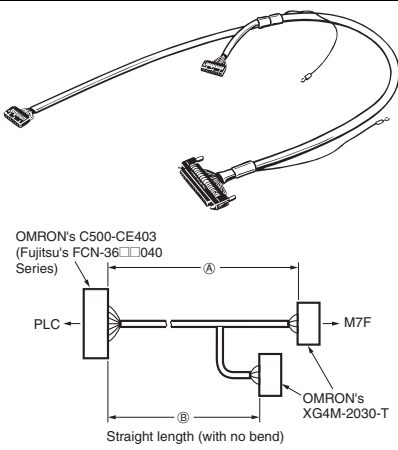
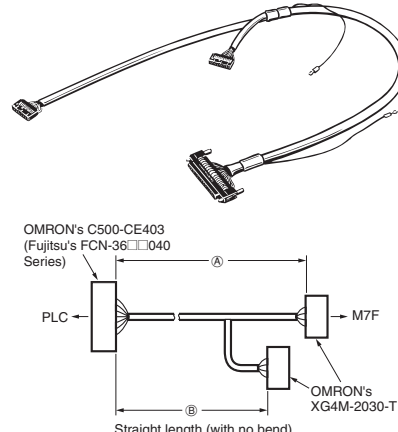
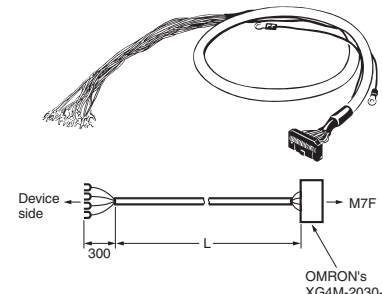
Model name	Application	Appearance	Ordering Information																					
<p>G79-□C Cable with Connectors (1 to 1)</p>	<p>Connects the M7F and a single device. Applicable PLC Output Units: C500-OD415CN, C200H-OD215, and C200H-MD215 (Output Units incorporating a 24-pin connector each)</p>	 <p>Connection</p>  <p>Note: The connector pin numbers are shown from the crimped sides of the connectors.</p>	<table border="1" data-bbox="1101 600 1401 792"> <thead> <tr> <th>L Dimensions</th> <th>Model</th> </tr> </thead> <tbody> <tr> <td>1,000 mm</td> <td>G79-100C</td> </tr> <tr> <td>1,500 mm</td> <td>G79-150C</td> </tr> <tr> <td>2,000 mm</td> <td>G79-200C</td> </tr> <tr> <td>3,000 mm</td> <td>G79-300C</td> </tr> <tr> <td>5,000 mm</td> <td>G79-500C</td> </tr> </tbody> </table>	L Dimensions	Model	1,000 mm	G79-100C	1,500 mm	G79-150C	2,000 mm	G79-200C	3,000 mm	G79-300C	5,000 mm	G79-500C									
L Dimensions	Model																							
1,000 mm	G79-100C																							
1,500 mm	G79-150C																							
2,000 mm	G79-200C																							
3,000 mm	G79-300C																							
5,000 mm	G79-500C																							
<p>G79-O□C-□ Cable with Connectors (1 to 2)</p>	<p>Connects the M7F and two devices. Suitable Output Units: C500-OD213, C200H-OD218, C200H-OD219, CQM1-OD213, CS1W-MD261, CJ1W-OD231, and CJ1W-OD261 (Output Units incorporating a 40-pin connector each)</p>	 <p>Straight length (with no bend)</p>	<table border="1" data-bbox="1069 1267 1458 1491"> <thead> <tr> <th colspan="2">L Dimensions</th> <th>For output</th> </tr> <tr> <th>A</th> <th>B</th> <th>Model</th> </tr> </thead> <tbody> <tr> <td>1,000 mm</td> <td>750 mm</td> <td>G79-O100C-75</td> </tr> <tr> <td>1,500 mm</td> <td>1,250 mm</td> <td>G79-O150C-125</td> </tr> <tr> <td>2,000 mm</td> <td>1,750 mm</td> <td>G79-O200C-175</td> </tr> <tr> <td>3,000 mm</td> <td>2,750 mm</td> <td>G79-O300C-275</td> </tr> <tr> <td>5,000 mm</td> <td>4,750 mm</td> <td>G79-O500C-475</td> </tr> </tbody> </table>	L Dimensions		For output	A	B	Model	1,000 mm	750 mm	G79-O100C-75	1,500 mm	1,250 mm	G79-O150C-125	2,000 mm	1,750 mm	G79-O200C-175	3,000 mm	2,750 mm	G79-O300C-275	5,000 mm	4,750 mm	G79-O500C-475
L Dimensions		For output																						
A	B	Model																						
1,000 mm	750 mm	G79-O100C-75																						
1,500 mm	1,250 mm	G79-O150C-125																						
2,000 mm	1,750 mm	G79-O200C-175																						
3,000 mm	2,750 mm	G79-O300C-275																						
5,000 mm	4,750 mm	G79-O500C-475																						
<p>G79-Y□C Cable with Crimp-style Terminals</p>	<p>Ideal for the connection of the M7F to devices incorporating screw terminals. Suitable Output Units: CS1W-OD211, CS1W-OD212, C200H-OD212, and C500-OD412</p>		<table border="1" data-bbox="1107 1662 1401 1854"> <thead> <tr> <th>L Dimensions</th> <th>Model</th> </tr> </thead> <tbody> <tr> <td>1,000 mm</td> <td>G79-Y100C</td> </tr> <tr> <td>1,500 mm</td> <td>G79-Y150C</td> </tr> <tr> <td>2,000 mm</td> <td>G79-Y200C</td> </tr> <tr> <td>3,000 mm</td> <td>G79-Y300C</td> </tr> <tr> <td>5,000 mm</td> <td>G79-Y500C</td> </tr> </tbody> </table>	L Dimensions	Model	1,000 mm	G79-Y100C	1,500 mm	G79-Y150C	2,000 mm	G79-Y200C	3,000 mm	G79-Y300C	5,000 mm	G79-Y500C									
L Dimensions	Model																							
1,000 mm	G79-Y100C																							
1,500 mm	G79-Y150C																							
2,000 mm	G79-Y200C																							
3,000 mm	G79-Y300C																							
5,000 mm	G79-Y500C																							

Specifications

■ Applicable EN Standards

Standards
EN61326 EN60529 UL61010-1

■ Ratings

Rated power supply		12 to 24 VDC	
Allowable voltage fluctuation range		90% to 110% of rated voltage	
Current consumption		200 mA max. (at 12 VDC) 100 mA max. (at 24 VDC)	
Input level	Static input	Positive	High: 9.6 V to power supply voltage Low: 0 to 3 V
		Negative	High: 4 V to power supply voltage Low: 0 to 1.5 V
	Dynamic input	Positive (See note.)	High: 4 V to power supply voltage Low: 0 to 1.5 V
Ambient temperature		Operating: -10 to 55°C (with no icing or condensation) Storage: -25 to 65°C (with no icing or condensation)	
Ambient humidity		Operating: 35% to 85% (with no icing or condensation)	

Note: Use an NPN open collector for the output of the connection device. The data signal, however, is positive logic and the strobe signal is negative logic.

■ Characteristics

Insulation resistance	100 MΩ min. (at 500 VDC) between each terminal and mounting panel
Dielectric strength	1,000 VAC, 50/60 Hz for 1 min between each terminal and mounting panel
Noise immunity (See note.)	Power terminal: ±500 V (normal mode) ±1,500 V (common mode) I/O cable: ±800 V (when the specified cable is used)
Vibration resistance	Destruction: 10 to 55 Hz, 1.5-mm double amplitude 10 sweeps of 5 min each in X, Y, and Z directions
Shock resistance	Malfunction: 300 m/s ² 3 times each in 6 directions on X, Y, and Z axes
Degree of protection	IEC IP40 (front panel only)

Note: Impulse conditions:
 Rise time: 1 ns +10% max.
 Pulse width: 100 ns, 1 μs
 Frequency: 100 Hz
 Polarity: Positive or negative
 Cable: OMRON's G79-100C

Operation

Input Codes

Numeric Display

Positive Logic Static Input (M7F-□P□□□)

	Input signal																Display condition			
	10 ³ digit				10 ² digit				10 ¹ digit				10 ⁰ digit							
Terminal no.	⑱	⑰	⑯	⑮	⑭	⑬	⑫	⑪	⑧	⑦	⑥	⑤	④	③	②	①	10 ³ digit	10 ² digit	10 ¹ digit	10 ⁰ digit
Terminal symbol	D4	C4	B4	A4	D3	C3	B3	A3	D2	C2	B2	A2	D1	C1	B1	A1				
Input signals	L	L	L	L	L	L	L	L	L	L	L	L	L	L	L	L	0	0	0	0
	L	L	L	H	L	L	L	H	L	L	L	H	L	L	L	H	1	1	1	1
	L	L	H	L	L	L	L	H	L	L	L	H	L	L	H	L	2	2	2	2
	L	L	H	H	L	L	L	H	H	L	L	H	H	L	H	H	3	3	3	3
	L	H	L	L	L	L	H	L	L	L	H	L	L	L	H	L	4	4	4	4
	L	H	L	H	L	L	H	L	H	L	H	L	H	L	H	L	5	5	5	5
	L	H	H	L	L	L	H	H	L	L	H	H	L	L	H	H	6	6	6	6
	L	H	H	H	L	L	H	H	H	L	H	H	H	L	H	H	7	7	7	7
	H	L	L	L	H	L	L	L	H	L	L	L	H	L	L	L	8	8	8	8
	H	L	L	H	H	L	L	H	H	L	L	H	H	L	L	H	9	9	9	9
	H	L	H	L	H	L	H	L	H	L	H	L	H	L	H	L	A	A	A	A
	H	L	H	H	H	L	H	H	H	L	H	H	H	L	H	H	b	b	b	b
	H	H	L	L	H	H	L	L	H	H	L	L	H	H	L	L	c	c	c	c
	H	H	L	H	H	H	L	H	H	H	L	H	H	H	L	H	d	d	d	d
	H	H	H	L	H	H	H	L	H	H	H	L	H	H	H	L	E	E	E	E
	H	H	H	H	H	H	H	H	H	H	H	H	H	H	H	H	F	F	F	F

Negative Logic Static Input (M7F-□N□□□)

	Input signal																Display condition			
	10 ³ digit				10 ² digit				10 ¹ digit				10 ⁰ digit							
Terminal no.	⑱	⑰	⑯	⑮	⑭	⑬	⑫	⑪	⑧	⑦	⑥	⑤	④	③	②	①	10 ³ digit	10 ² digit	10 ¹ digit	10 ⁰ digit
Terminal symbol	D4	C4	B4	A4	D3	C3	B3	A3	D2	C2	B2	A2	D1	C1	B1	A1				
Input signals	H	H	H	H	H	H	H	H	H	H	H	H	H	H	H	H	0	0	0	0
	H	H	H	L	H	H	H	L	H	H	H	L	H	H	H	L	1	1	1	1
	H	H	L	H	H	H	L	H	H	H	L	H	H	H	L	H	2	2	2	2
	H	H	L	L	H	H	L	L	H	H	L	L	H	H	L	L	3	3	3	3
	H	L	H	H	H	L	H	H	H	L	H	H	H	L	H	H	4	4	4	4
	H	L	H	L	H	L	H	L	H	L	H	L	H	L	H	L	5	5	5	5
	H	L	L	H	H	L	L	H	H	L	L	H	H	L	L	H	6	6	6	6
	H	L	L	L	H	L	L	L	H	L	L	L	H	L	L	L	7	7	7	7
	L	H	H	H	L	H	H	H	L	H	H	H	L	H	H	H	8	8	8	8
	L	H	H	L	L	H	H	L	L	H	H	L	L	H	H	L	9	9	9	9
	L	H	L	H	L	H	L	H	L	H	L	H	L	H	L	H	A	A	A	A
	L	H	L	L	L	H	L	L	L	H	L	L	L	H	L	L	b	b	b	b
	L	L	H	H	L	L	H	H	L	L	H	H	L	L	H	H	c	c	c	c
	L	L	H	L	L	L	H	L	L	L	H	L	L	L	H	L	d	d	d	d
	L	L	L	H	L	L	L	H	L	L	L	H	L	L	L	H	E	E	E	E
	L	L	L	L	L	L	L	L	L	L	L	L	L	L	L	L	F	F	F	F

Dynamic Input (M7F-□D□□□□)

Terminal no.	Input signal									Display condition				
	④	③	②	①	⑪	⑫	⑬	⑭	⑮	10 ⁴ digit	10 ³ digit	10 ² digit	10 ¹ digit	10 ⁰ digit
Terminal symbol	D	C	B	A	S0	S1	S2	S3	S4					
Input signals	L	L	L	L	L	H	H	H	H	*	*	*	*	0
	L	L	L	H	H	L	H	H	H	*	*	*	1	*
	L	L	H	L	H	H	L	H	H	*	*	2	*	*
	L	L	H	H	H	H	H	L	H	*	3	*	*	*
	L	H	L	L	H	H	H	H	L	4	*	*	*	*
	L	H	L	H	L	H	H	H	H	*	*	*	*	5
	L	H	H	L	H	L	H	H	H	*	*	*	6	*
	L	H	H	H	H	H	L	H	H	*	*	7	*	*
	H	L	L	L	H	H	H	L	H	*	8	*	*	*
	H	L	L	H	H	H	H	H	L	9	*	*	*	*
	H	L	H	L	L	H	H	H	H	*	*	*	*	a
	H	H	L	L	H	H	L	H	H	*	*	€	*	*
	H	H	L	H	H	H	H	L	H	*	d	*	*	*
	H	H	H	L	H	H	H	H	L	£	*	*	*	*
H	H	H	H	L	H	H	H	H	*	*	*	*	F	

* The data of S0 to S4 when S0 to S4 are high before S0 to S4 become low will be held and displayed. Refer to *Operation Timing (Input Signal Timing)* on page 12 and *Operation Chart* on page 12 for details.

Unit Display

The displays are lit when voltage is supplied to the power supply terminals (positive and negative terminals).

Minus Symbol and Decimal Point

The DIP switch is used for minus symbol and decimal point settings as shown in the following table.

Display contents	Model	DIP switch function
Three digits Numerals and minus symbol	M7F-3□□□F	
Three digits Numerals and unit	M7F-3□□□T	
Four digits Numerals only	M7F-4□□□□	
Four digits Numerals and minus symbol	M7F-4□□□F	
Four digits Numerals and unit	M7F-4□□□T	
Five digits Numerals only	M7F-5□□□□	

Note: 1. The minus symbol and decimal point are always lit when the corresponding pins of the DIP switch are set to ON.
2. "NC" means "not connected".

Zero Suppression Function

The Unit has a function for blanking (i.e., turning OFF the display) to not display 0 when the leftmost digits are zero. When DP (decimal point) has been displayed using the DIP switch, the digits to the left of the decimal point display digit will be blank as shown in the following figure.

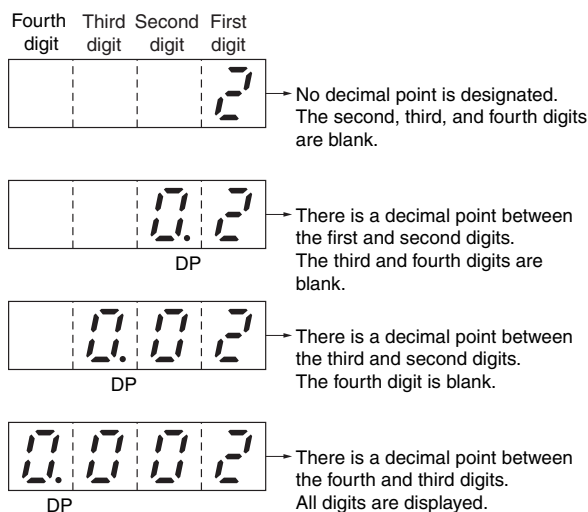

Note: The zero suppression function is normally operating.

Terminal Arrangement/Functions

Terminal Arrangement

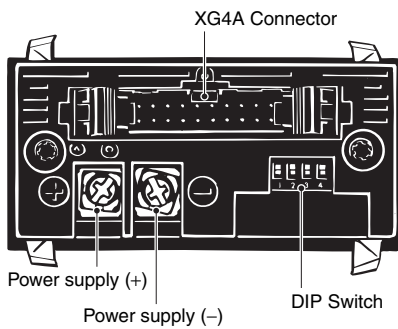

XG4A Connector

Static Input Model

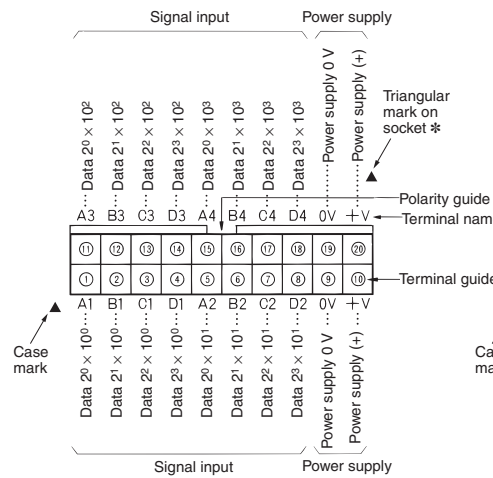

Dynamic Input Model

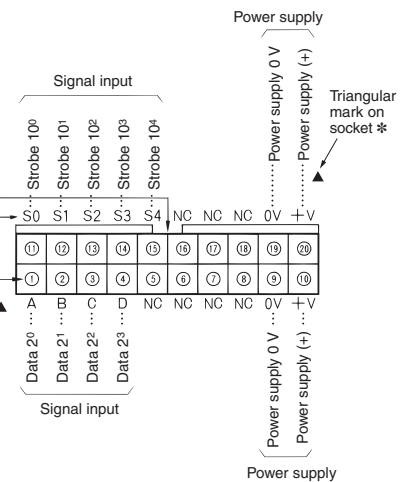

- Note:**
1. Circled numbers are for the user's convenience. When preparing a socket, pay attention when wiring the terminals to the direction of the polarity guide.
 2. The triangular mark (▲) on the M7F case indicates the start of the M7F terminal numbers. It does not line up with the triangular mark (▲) on the connector. Incorrect wiring may cause a short-circuit in the sequence output section, which could damage it.
- * This is the location of the triangular mark on the XG4M-2030 Socket that is attached to the Cable.

Terminal Functions

Input method	Terminal symbol	Name	Function	
Static input	A1 B1 C1 D1	First digit (10 ⁰) data input	A1 (2 ⁰) B1 (2 ¹) C1 (2 ²) D1 (2 ³)	The numeral or symbol corresponding to the binary code signal will be displayed as the first digit (10 ⁰).
	A2 B2 C2 D2	Second digit (10 ¹) data input	A2 (2 ⁰) B2 (2 ¹) C2 (2 ²) D2 (2 ³)	The numeral or symbol corresponding to the binary code signal will be displayed as the second digit (10 ¹).
	A3 B3 C3 D3	Third digit (10 ²) data input	A3 (2 ⁰) B3 (2 ¹) C3 (2 ²) D3 (2 ³)	The numeral or symbol corresponding to the binary code signal will be displayed as the third digit (10 ²).
	A4 B4 C4 D4	Fourth digit (10 ³) data input	A4 (2 ⁰) B4 (2 ¹) C4 (2 ²) D4 (2 ³)	The numeral or symbol corresponding to the binary code signal will be displayed as the fourth digit (10 ³).
	+V	Power supply	Power supply and output terminal	
	0 V	Power supply	Power supply 0-V output terminal (GND)	
Dynamic input	A B C D	Data input	A (2 ⁰) B (2 ¹) C (2 ²) D (2 ³)	Displays the numeral or symbol corresponding to the binary code signal.
	S0 S1 S2 S3 S4	Control input	S0 (10 ⁰) S1 (10 ¹) S2 (10 ²) S3 (10 ³) S4 (10 ⁴)	Designates the digit to be displayed. Each digit will maintain the previous value when this signal is input.
	+V	Power supply	Power supply and output terminal	
	0 V	Power supply	Power supply 0-V output terminal (GND)	

DIP Switch Function

The DIP switch is used for symbol and decimal point settings. Refer to *Terminal Arrangement*, above, for details.

Block Diagram

Note: Circled numbers are the connector pin numbers.

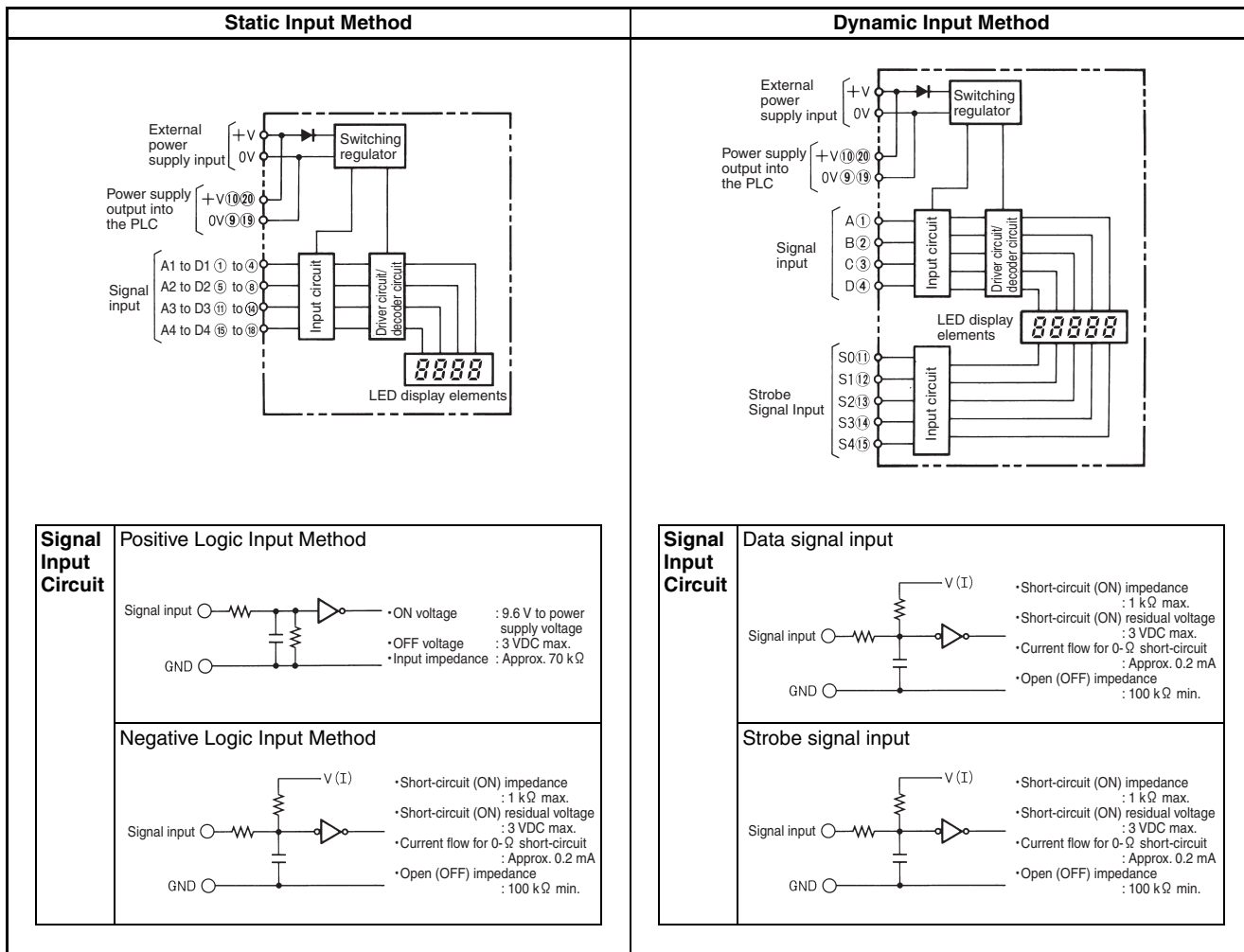

External Connections

Refer to *Block Diagram* on page 8 and *Terminal Arrangement* on page 7 for external connections for the M7F according to the signal input method.

PLC Connections

- Refer to your PLC operation manual before connecting the PLC.
- The M7F connects to the PLC without using any external resistor.
- It is necessary to select the correct input method of the M7F according to the output method of the PLC Output Unit. Refer to *Connectable PLCs* on page 2 for details on the selection of the correct input method.
- A PLC Dynamic Output Unit can be used to save wiring. Use a dynamic input model (M7F-□D□□□).

With PLC Static Output Unit

1. M7F-□P□□□ Static Positive Logic Input Model

Connected to C500-OD212 Output Unit



Circuit Configuration



- Note:**
1. Use the M7F positive logic input model if the PLC Output Unit has PNP output.
 2. The PLC connects to the M7F with ease via the enclosed G79-Y□C Cable (with connectors, sold separately).

2. M7F-□N□□□ Static Negative Logic Input Model

1. Connected to C500-OD213 Output Unit



Circuit Configuration



Note: The PLC connects to the M7F with ease via the G79-O□C-□ Cable (with connectors, sold separately).
(The above example indicates 1 to 1 connection.)

2. Connected to C200H-OD215 Output Unit



Circuit Configuration



Note: 1. If the C200H-OD215 is used as a Static Output Unit, the switches on the rear panel of the PLC must be set as described in the following table.

SW1 (static output mode)	OFF
SW2	OFF
SW3	OFF
SW4	OFF
SW5 (negative logic output)	OFF
SW6	OFF

Refer to your PLC operation manual for details.

2. A G79-□C Connecting Cable (with connectors, sold separately) can be used to easily connect the PLC to the M7F.

With PLC Dynamic Output Unit
M7F-□D□□□ Dynamic Input Model

Connected to C200H-OD215 Output Unit

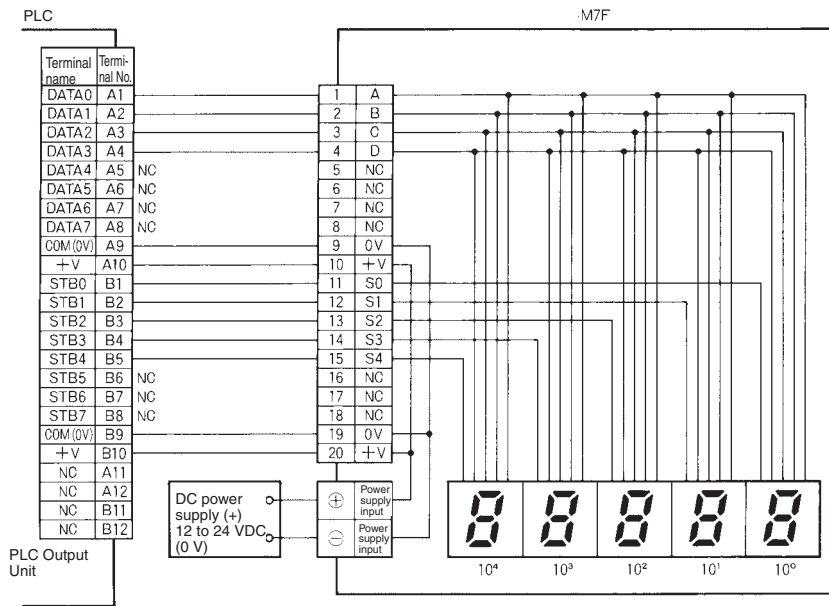

Circuit Configuration

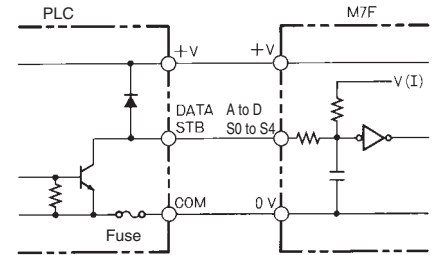

Note: 1. If the C200H-OD215 is used as a Dynamic Output Unit, the switches on the rear panel of the PLC must be set as described in the following table.

SW1 (dynamic output mode)	ON
SW2	OFF
SW3	OFF
SW4	OFF
SW5 (positive logic output)	ON
SW6	OFF

Refer to your PLC operation manual for details.

2. A G79-□C Connecting Cable (with connectors, sold separately) can be used to easily connect the PLC to the M7F.

3. An eight-bit data signal is allocated to each strobe signal of the C200H-OD215 Dynamic Output Unit. On the other hand, each strobe signal is input only to the rightmost four bits of the M7F. Thus the following program must run.

1. Status before PLC Program Runs (Data Storage Status)

Relay no.	15	14	13	12	11	10	09	08	07	06	05	04	03	02	01	00
Data no.	7	6	5	4	3	2	1	0	7	6	5	4	3	2	1	0
Word no.	005	4			3			2			1					
	006	/			/			/			/			5		
	007	/			/			/			/			/		
	008	/			/			/			/			/		

Note: Word numbers and data are examples.

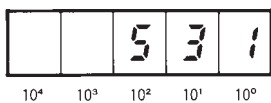

M7F's display

2. Example of PLC Program Operation

(Refer to your PLC operation manual for details.)

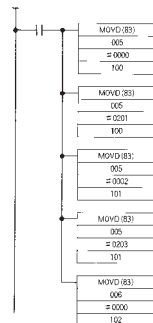

Transfers the first digit's data of word 005 to the first digit of word 100.

Transfers the second digit's data of word 005 to the third digit of word 100.

Transfers the third digit's data of word 005 to the first digit of word 101.

Transfers the fourth digit's data of word 005 to the third digit of word 101.

Transfers the first digit data of word 006 to the first digit of word 102.

3. Status after PLC Program Has Run (Data Storage Status)

Relay no.	15	14	13	12	11	10	09	08	07	06	05	04	03	02	01	00
Data no.	7	6	5	4	3	2	1	0	7	6	5	4	3	2	1	0
Word no.	100	/			2			/			1			/		
	101	/			4			/			3			/		
	102	/			/			/			5			/		
	103	/			/			/			/			/		

Note: Word numbers and data are examples.

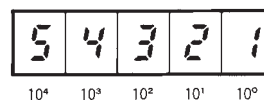

M7F's display

Operation

■ Operation Timing (Input Signal Timing)

Dynamic Input Method (M7F-□D□□□)

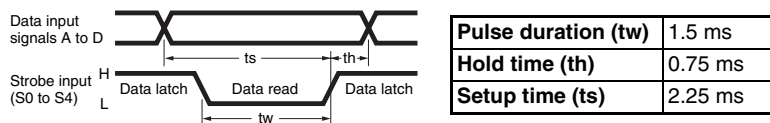

■ Operation Chart

Dynamic Input Method (M7F-□D□□□)

The following example shows the relationship between each input terminal and the display condition. (Example: 5-digit)

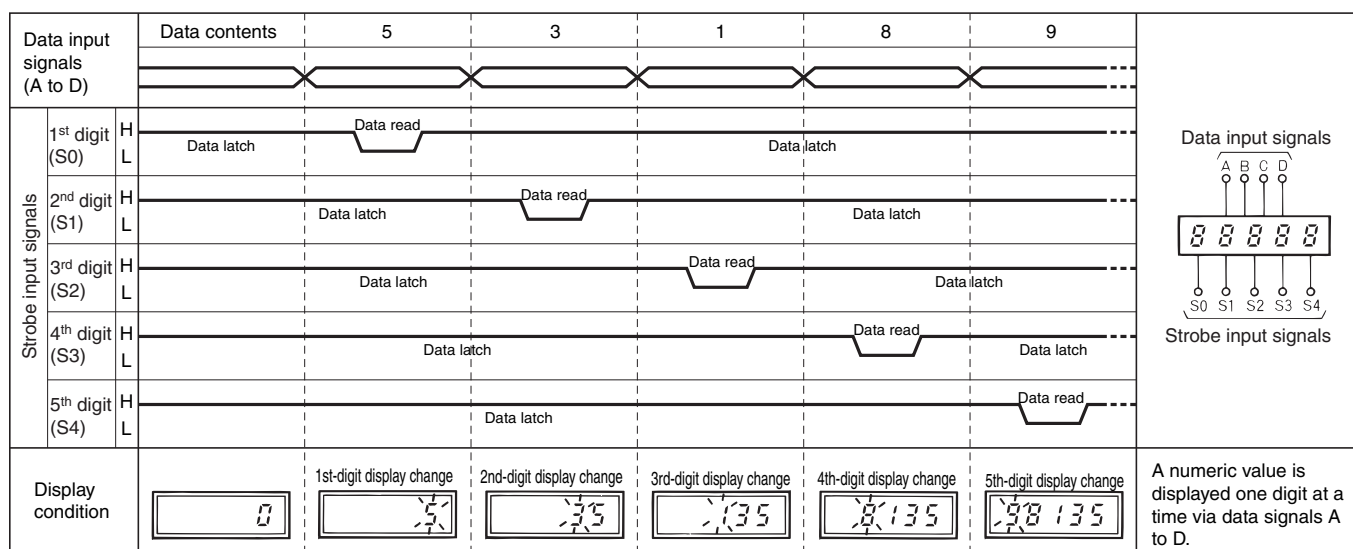

Dimensions

Note: All units are in millimeters unless otherwise indicated.

M7F-□□1□□

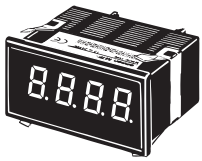

The M7F-4□1□ is illustrated.

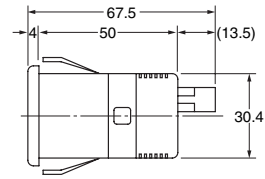
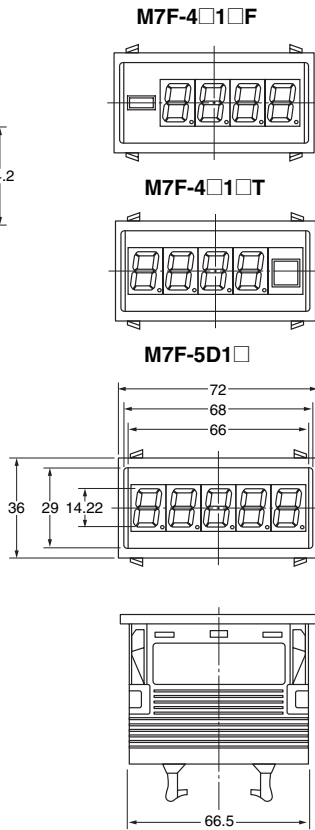
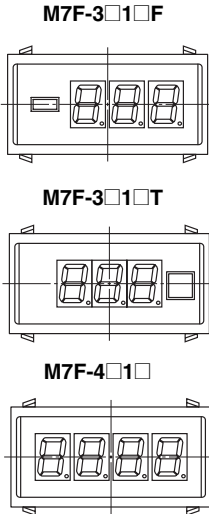
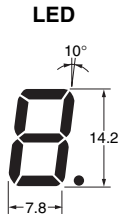

Panel Cutout
(Single Mounting)

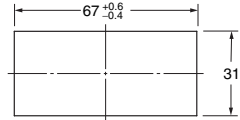

(Side-by-side Mounting)

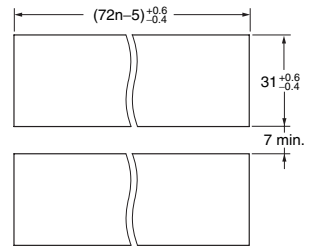

Panel thickness: 1 to 6 mm
n: Number of Units mounted

Safety Precautions

CAUTION

Tighten the screws on the terminal block securely using the recommended tightening torque of 0.29 to 0.49 N·m. Loose screws may occasionally cause fire, resulting in minor or moderate injury, or damage to the equipment.



Precautions for Safe Use

- Do not use or store the product in the following locations.
 - Locations subject to direct radiant heat from heating equipment
 - Locations where the product may come into contact with water, oil, or salt water
 - Locations subject to direct sunlight
 - Locations where dust or corrosive gases (in particular, sulfuric or ammonia gas) are present
 - Locations subject to extreme temperature changes
 - Locations where icing or condensation may occur
 - Locations subject to excessive shocks or vibration
 - Locations subject to temperatures or humidity outside the specified range
 - Locations outdoors or exposed to wind or rain
 - Locations subject to static electricity or noise
- Do not use the product in locations subject to temperatures outside the specified ranges or in locations subject to condensation. If the product is installed in a panel, be sure that the temperature around the product (not the temperature around the panel) does not go outside the specified range. The life of components is dependent on the temperature. The life of components shortens when the temperature rises, and it lengthens when the temperature falls. The life of components can be lengthened by lowering the temperature inside the product.
- Do not install the product near devices generating strong high frequency waves or surges. When using a noise filter, check the voltage and current and install it as close to the product as possible.
- Do not touch terminals or perform wiring while power is supplied to the product. Doing so may result in injury or malfunction.
- Do not touch the terminals while power is being supplied. Doing so may result in product failure or malfunction.
- When tightening the terminals or connecting connectors, support the product with one hand to prevent it from being pushed out of the front of the panel.
- Wire to the correct terminal number. Incorrect wiring may result in damage to or burning of components.
- Be sure power supplies and power lines for control power supply and inputs have appropriate specifications. Not using power supplies and power lines with appropriate specifications may result in malfunction, burning, or electric shock.
- Do not attempt to disassemble, repair, or modify the product. Doing so may occasionally result in minor or moderate injury.
- Do not allow pieces of metal, wire clippings, or fine metallic shavings or filings to enter the product. Doing so may occasionally result in fire or product failure.
- For DC input, use an SELV power supply with overcurrent protection. Specifically, use an SELV power supply with double or reinforced insulation between input and output, and an output voltage of 30 Vrms with 42.2 V peak or 60 VDC maximum. Recommended power supply: S8VS-06024□ (OMRON product)

Precaution for Correct Use

Wiring

- Do not tighten the power supply terminals with excessive force when wiring. Doing so may damage the terminals. Tighten each of them to a torque of 0.29 to 0.49 N·m.
- Do not impose excessive force on the rear panel when tightening the terminals of the M7F or connecting a connector to the M7F.
- When tightening the terminals of the M7F or connecting a connector to the M7F, hold the displays by hand, otherwise the displays may protrude from the case.

Environment

When using the M7F in places with dust, metal powder, or sprayed oil, be sure to take appropriate measures so that no dust, metal powder, or sprayed oil will penetrate the interior of the Display Units.

Mounting

- When panel-mounting, make sure that the side of the case marked "TOP" is upward.
- When panel-mounting, do not press the central part of the displays, otherwise the displays may be damaged. Press the flange part.

Connections

- If power will be supplied to the M7F from the PLC's I/O service power supply, make sure that the current consumption of the M7F does not exceed the rated capacity of the service power supply.
- It is recommended to supply power to the M7F from a dedicated DC power supply in order to protect the PLC from being damaged.
- When using a controller other than the PLC or another company's PLC, be sure to check the terminal arrangement of the connector of the controller or the PLC. The terminal arrangement of OMRON's cables incorporating connectors corresponds to that of the PLC.

Removing Color Plate

There is a gap (with a width of approximately 1 mm) between the case and color plate on the left and right sides. To remove the color plate, insert a flat-blade screwdriver into either one of the gaps and move the color plate upwards.

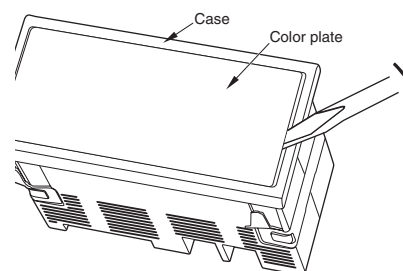

Replacing Unit Plate

- Remove the unit plate with a pair of tweezers.
- Before pasting a unit plate to the plate holder, remove the ground paper from the unit plate. Paste the unit plate to the plate holder so that the symbol mark or character(s) of the face plate will be on the bottom side (i.e., the decimal-point side) of the M7F.

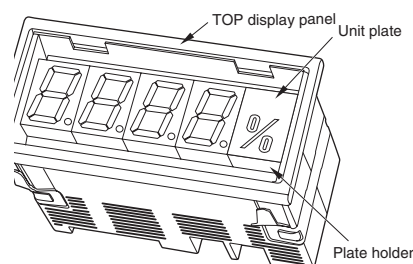

Attaching Color Plate

Insert the projecting parts of the color plate into the square holes of the case to attach the color plate to the case.

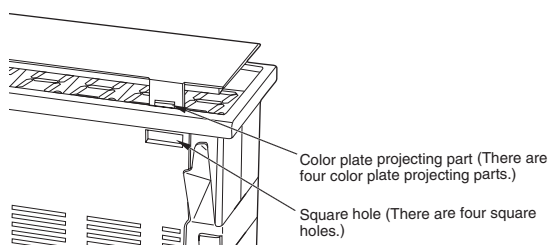

DIP Switch Settings

The DIP switch can be set with the tip of a ball-point pen or small screwdriver. Do not use anything that has a sharp edge (e.g., tweezers) to set the DIP switch.

ALL DIMENSIONS SHOWN ARE IN MILLIMETERS.

To convert millimeters into inches, multiply by 0.03937. To convert grams into ounces, multiply by 0.03527.

In the interest of product improvement, specifications are subject to change without notice.

Terms and Conditions Agreement

Read and understand this catalog.

Please read and understand this catalog before purchasing the products. Please consult your OMRON representative if you have any questions or comments.

Warranties.

(a) Exclusive Warranty. Omron's exclusive warranty is that the Products will be free from defects in materials and workmanship for a period of twelve months from the date of sale by Omron (or such other period expressed in writing by Omron). Omron disclaims all other warranties, express or implied.

(b) Limitations. OMRON MAKES NO WARRANTY OR REPRESENTATION, EXPRESS OR IMPLIED, ABOUT NON-INFRINGEMENT, MERCHANTABILITY OR FITNESS FOR A PARTICULAR PURPOSE OF THE PRODUCTS. BUYER ACKNOWLEDGES THAT IT ALONE HAS DETERMINED THAT THE PRODUCTS WILL SUITABLY MEET THE REQUIREMENTS OF THEIR INTENDED USE.

Omron further disclaims all warranties and responsibility of any type for claims or expenses based on infringement by the Products or otherwise of any intellectual property right. (c) Buyer Remedy. Omron's sole obligation hereunder shall be, at Omron's election, to (i) replace (in the form originally shipped with Buyer responsible for labor charges for removal or replacement thereof) the non-complying Product, (ii) repair the non-complying Product, or (iii) repay or credit Buyer an amount equal to the purchase price of the non-complying Product; provided that in no event shall Omron be responsible for warranty, repair, indemnity or any other claims or expenses regarding the Products unless Omron's analysis confirms that the Products were properly handled, stored, installed and maintained and not subject to contamination, abuse, misuse or inappropriate modification. Return of any Products by Buyer must be approved in writing by Omron before shipment. Omron Companies shall not be liable for the suitability or unsuitability or the results from the use of Products in combination with any electrical or electronic components, circuits, system assemblies or any other materials or substances or environments. Any advice, recommendations or information given orally or in writing, are not to be construed as an amendment or addition to the above warranty.

See <http://www.omron.com/global/> or contact your Omron representative for published information.

Limitation on Liability; Etc.

OMRON COMPANIES SHALL NOT BE LIABLE FOR SPECIAL, INDIRECT, INCIDENTAL, OR CONSEQUENTIAL DAMAGES, LOSS OF PROFITS OR PRODUCTION OR COMMERCIAL LOSS IN ANY WAY CONNECTED WITH THE PRODUCTS, WHETHER SUCH CLAIM IS BASED IN CONTRACT, WARRANTY, NEGLIGENCE OR STRICT LIABILITY.

Further, in no event shall liability of Omron Companies exceed the individual price of the Product on which liability is asserted.

Suitability of Use.

Omron Companies shall not be responsible for conformity with any standards, codes or regulations which apply to the combination of the Product in the Buyer's application or use of the Product. At Buyer's request, Omron will provide applicable third party certification documents identifying ratings and limitations of use which apply to the Product. This information by itself is not sufficient for a complete determination of the suitability of the Product in combination with the end product, machine, system, or other application or use. Buyer shall be solely responsible for determining appropriateness of the particular Product with respect to Buyer's application, product or system. Buyer shall take application responsibility in all cases.

NEVER USE THE PRODUCT FOR AN APPLICATION INVOLVING SERIOUS RISK TO LIFE OR PROPERTY OR IN LARGE QUANTITIES WITHOUT ENSURING THAT THE SYSTEM AS A WHOLE HAS BEEN DESIGNED TO ADDRESS THE RISKS, AND THAT THE OMRON PRODUCT(S) IS PROPERLY RATED AND INSTALLED FOR THE INTENDED USE WITHIN THE OVERALL EQUIPMENT OR SYSTEM.

Programmable Products.

Omron Companies shall not be responsible for the user's programming of a programmable Product, or any consequence thereof.

Performance Data.

Data presented in Omron Company websites, catalogs and other materials is provided as a guide for the user in determining suitability and does not constitute a warranty. It may represent the result of Omron's test conditions, and the user must correlate it to actual application requirements. Actual performance is subject to the Omron's Warranty and Limitations of Liability.

Change in Specifications.

Product specifications and accessories may be changed at any time based on improvements and other reasons. It is our practice to change part numbers when published ratings or features are changed, or when significant construction changes are made. However, some specifications of the Product may be changed without any notice. When in doubt, special part numbers may be assigned to fix or establish key specifications for your application. Please consult with your Omron's representative at any time to confirm actual specifications of purchased Product.

Errors and Omissions.

Information presented by Omron Companies has been checked and is believed to be accurate; however, no responsibility is assumed for clerical, typographical or proofreading errors or omissions.

2013.7

In the interest of product improvement, specifications are subject to change without notice.

OMRON Corporation
Industrial Automation Company

<http://www.ia.omron.com/>

(c)Copyright OMRON Corporation 2013 All Right Reserved.