

## Data sheet | Item number: 2042-3829

Relay module; Nominal input voltage: 24 ... 230 V AC/DC; 4 make contacts;  
Limiting continuous current: 3 A; Green status indicator; Module width: 25 mm

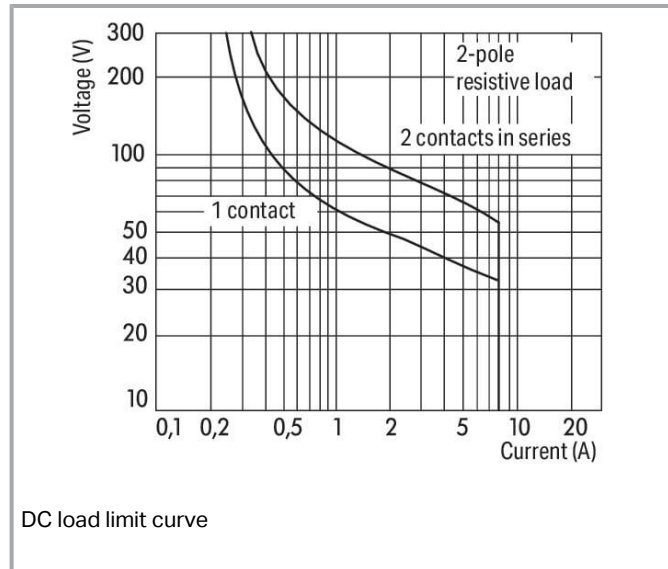

[www.wago.com/2042-3829](http://www.wago.com/2042-3829)

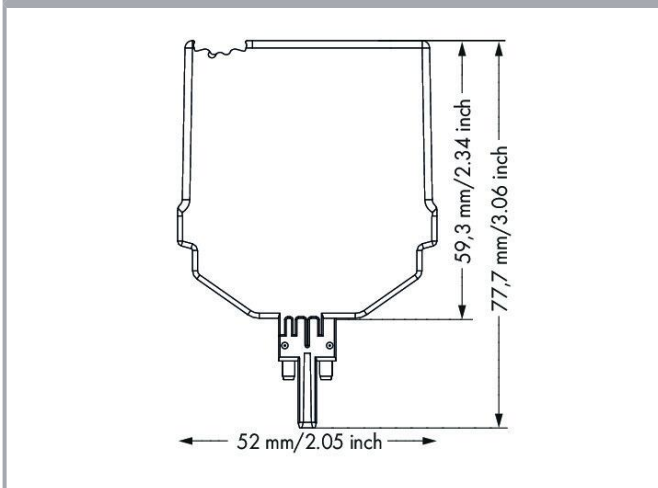
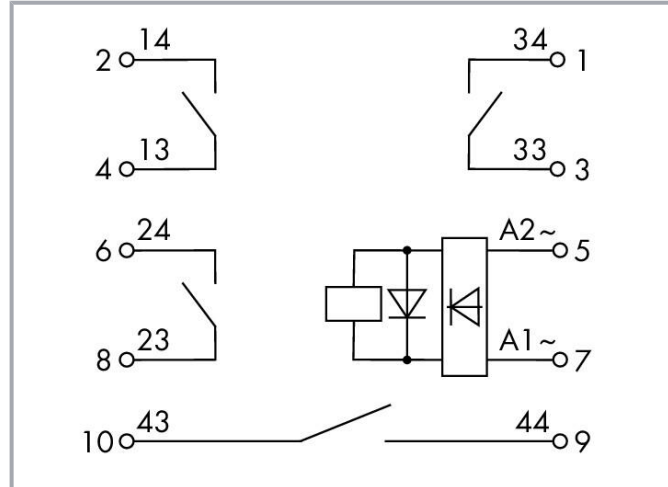

DC load limit curve

## Data

### Technical data

Subject to changes. Please also observe the further product documentation!

WAGO GmbH & Co. KG  
Hansastr. 27  
32423 Minden  
Phone: +49571 887-0 | Fax: +49571 887-169  
Email: [info.de@wago.com](mailto:info.de@wago.com) | Web: [www.wago.com](http://www.wago.com)

Do you have any questions about our products?  
We are always happy to take your call at +49 (571) 887-44222.



## Control Circuit

Nominal input voltage $U_N$	AC/DC 24 ... 230 V
Input voltage range	$\pm 10\%$
Nominal input current at $U_N$	6 mA (230 V); 58.4 mA (24 V)

## Load circuit

Number of make/switch-on contacts	4
Contact material (relay)	AgNi
Limiting continuous current	3 A
Inrush current (resistive) max.	(AC) 15 A / 4 s
Switching voltage (max.)	AC 250 V
Switching power (resistive) max.	AC 750 VA; DC (see load limit curve)
Recommended minimum load	12 V / 10 mA
Pull-in time (typ.)	8 ms
Drop-out time (typ.)	6 ms
Bounce time (typ.)	4 ms
Electrical life (NO; resistive load; 23 °C)	100 x 10 <sup>3</sup> switching operations
Mechanical life	10 x 10 <sup>6</sup> switching operations

## Signaling

Status indicator	Green LED
------------------	-----------

## Safety and protection

Rated voltage	250 V
Pollution degree	2
Dielectric strength (control/load circuit) (AC, 1 min)	3 kVrms
Dielectric strength (open contact) (AC, 1 min)	1 kVrms
Dielectric strength (channel/channel) (AC, 1 min)	1.5 kVrms
Protection type	IP20

## Physical data

Width	25.9 mm / 1.02 inches
Height	77.7 mm / 3.059 inches
Height from the surface	59.3 mm / 2.335 inches

Subject to changes. Please also observe the further product documentation!

WAGO GmbH & Co. KG  
 Hansastr. 27  
 32423 Minden  
 Phone: +49571 887-0 | Fax: +49571 887-169  
 Email: [info.de@wago.com](mailto:info.de@wago.com) | Web: [www.wago.com](http://www.wago.com)

Do you have any questions about our products?  
 We are always happy to take your call at +49 (571) 887-44222.



Depth	52 mm / 2.047 inches
-------	----------------------

**Mechanical data**

Mounting type	Pluggable module for TOPJOB® S carrier terminal block
---------------	---

**Material Data**

Flammability class per UL94	V0
Fire load	0.255 MJ
Weight	59.5 g

**Environmental requirements**

Ambient temperature (operation at U <sub>N</sub> )	-40 ... +50 °C
Ambient temperature (storage)	-40 ... +85 °C
Processing temperature	-25 ... +50 °C
Operating altitude (max.)	2000 m

**Standards and specifications**

Standards/specifications	EN 61010-2-201 EN 61373 EN 50121-3-2
--------------------------	--

**Commercial data**

eCl@ss 10.0	27-14-11-49
eCl@ss 9.0	27-14-11-49
ETIM 8.0	EC002018
ETIM 7.0	EC002018
PU (SPU)	5 pcs
Packaging type	box
Country of origin	DE
GTIN	4055143651936
Customs tariff number	85364900990

**Environmental Product Compliance**



CAS-No.	11120-22-2 7439-92-1
---------	-------------------------

Subject to changes. Please also observe the further product documentation!

	79-94-7 80-05-7
REACH Candidate List Substance	2,2',6,6'-tetrabromo-4,4'-isopropylidenediphenol 4,4'-isopropylidenediphenol Lead Lead silicate
RoHS Compliance Status	Compliant,With Exemption
RoHS Exemption	7(a) 7(c)-I 7(c)-II
SCIP notification number (Austria)	5b5e26f1-26a3-4aa2-a3a3-4f1b449161eb
SCIP notification number (Belgium)	69c15af2-df66-437c-ad00-510b9cd98035
SCIP notification number (Bulgaria)	4eafbc78-1e5b-4fdb-9f71-039c2173c0fc
SCIP notification number (Czech Republic)	9b51b07e-233b-4d8c-bcf8-3b53ef69f3db
SCIP notification number (Denmark)	65dd15ab-5a48-41eb-a027-59e54c887850
SCIP notification number (Finland)	39bdb197-a439-4961-874c-c3089e896473
SCIP notification number (France)	765e841a-a4a9-4549-883a-aadf0d93fcdd
SCIP notification number (Germany)	5ed49ed7-0606-4483-a09d-41fb5a638e62
SCIP notification number (Hungary)	859c5770-c0bd-44d3-a8e7-be5cc0fdcc16
SCIP notification number (Italy)	ab9bc628-5af3-4f4f-a8df-e5efa0d1387d
SCIP notification number (Netherlands)	98f2c965-f664-4f80-a008-641bfca63164
SCIP notification number (Poland)	8aa6c3aa-c3b1-45e8-8c18-443666659c59
SCIP notification number (Romania)	e4e45d00-1f3e-4bd0-8cee-b867472e84e3
SCIP notification number (Sweden)	a754a5db-3fa1-4b5a-ba73-52d5451297cc

## Approvals / Certificates

### General approvals

Logo	Approval	Additional Approval Text	Certificate name
	EAC Brjansker Zertifizierungsstelle	TP TC 020/2011	EAC_Certificate_RU_C-DE.AM02.B.00115_19
	EAC Brjansker Zertifizierungsstelle	TP TC 004/2011	EAC RU C-DE.AM02.B.00122/19
	UL Underwriters Laboratories Inc. (ORDINARY LOCATIONS)	UL 61010-1	E175199

Subject to changes. Please also observe the further product documentation!

## Declarations of conformity and manufacturer's declarations

Logo	Approval	Additional Approval Text	Certificate name
	EU-Declaration of Conformity WAGO GmbH & Co. KG	-	-

## Optional accessories

## Terminal blocks

Carrier terminal block for modules and plugs

**Item no.: 2002-1961**2-conductor carrier terminal block; with additional jumper position; for DIN-rail 35 x 15 and 35 x 7.5; 2.5 mm<sup>2</sup>; Push-in CAGE CLAMP®; 2,50 mm<sup>2</sup>; gray [www.wago.com/2002-1961](http://www.wago.com/2002-1961)**Item no.: 2002-1761**3-conductor carrier terminal block; for DIN-rail 35 x 15 and 35 x 7.5; 2.5 mm<sup>2</sup>; Push-in CAGE CLAMP®; 2,50 mm<sup>2</sup>; gray [www.wago.com/2002-1761](http://www.wago.com/2002-1761)**Item no.: 2002-1861**4-conductor carrier terminal block; for DIN-rail 35 x 15 and 35 x 7.5; 2.5 mm<sup>2</sup>; Push-in CAGE CLAMP®; 2,50 mm<sup>2</sup>; gray [www.wago.com/2002-1861](http://www.wago.com/2002-1861)

## Marking accessories

Marking strip

**Item no.: 2009-110**

Marking strips; for Smart Printer; on reel; not stretchable; plain; snap-on type; white

[www.wago.com/2009-110](http://www.wago.com/2009-110)

Marker

**Item no.: 2009-115**

WMB-Inline; for Smart Printer; 1500 pieces on roll; stretchable 5 - 5.2 mm; plain; snap-on type; white

[www.wago.com/2009-115](http://www.wago.com/2009-115)**Item no.: 793-501**

WMB marking card; as card; not stretchable; plain; snap-on type; white

[www.wago.com/793-501](http://www.wago.com/793-501)**Item no.: 793-5501**WMB marking card; as card; for terminal block width 5 - 17.5 mm; stretchable 5 - 5.2 mm; plain; snap-on type; white [www.wago.com/793-5501](http://www.wago.com/793-5501)

## End plate

End plate

**Item no.: 2002-1892**

End and intermediate plate; 1 mm thick; orange

[www.wago.com/2002-1892](http://www.wago.com/2002-1892)

Subject to changes. Please also observe the further product documentation!

WAGO GmbH &amp; Co. KG

Hansastr. 27

32423 Minden

Phone: +49571 887-0 | Fax: +49571 887-169

Email: [info.de@wago.com](mailto:info.de@wago.com) | Web: [www.wago.com](http://www.wago.com)

Do you have any questions about our products?

We are always happy to take your call at +49 (571) 887-44222.



	<b>Item no.: 2002-1891</b> End and intermediate plate; 1 mm thick; gray	<a href="http://www.wago.com/2002-1891">www.wago.com/2002-1891</a>
	<b>Item no.: 2002-1991</b> End and intermediate plate; 1 mm thick; gray	<a href="http://www.wago.com/2002-1991">www.wago.com/2002-1991</a>
	<b>Item no.: 2002-1992</b> End and intermediate plate; 1 mm thick; orange	<a href="http://www.wago.com/2002-1992">www.wago.com/2002-1992</a>
	<b>Item no.: 2002-1691</b> End and intermediate plate; 1 mm thick; gray	<a href="http://www.wago.com/2002-1691">www.wago.com/2002-1691</a>
	<b>Item no.: 2002-1692</b> End and intermediate plate; 1 mm thick; orange	<a href="http://www.wago.com/2002-1692">www.wago.com/2002-1692</a>
	<b>Item no.: 2002-1791</b> End and intermediate plate; 1 mm thick; gray	<a href="http://www.wago.com/2002-1791">www.wago.com/2002-1791</a>
	<b>Item no.: 2002-1792</b> End and intermediate plate; 1 mm thick; orange	<a href="http://www.wago.com/2002-1792">www.wago.com/2002-1792</a>

## Downloads

### Documentation

#### Bid Text

2042-3829 docx - Datei	2019 Feb 20	docx 17.3 kB	Download
2042-3829 X81 - Datei	2019 Feb 19	xml 3.9 kB	Download

#### Instruction Leaflet

Pluggable Relay Module / Pluggable Solid-State Relay Module	V 1.1.0	pdf 2.0 MB	Download
---	---------	---------------	----------

#### Additional Information

Disposal and Recycling Electrical and electronic equipment, Batteries, Packaging	V 1.1.0 2022 Aug 18	pdf 2.2 MB	Download
---	------------------------	---------------	----------

## CAD/CAE-Data

### CAD data

2D/3D Models 2042-3829	URL	Download
------------------------	-----	----------

Subject to changes. Please also observe the further product documentation!



#### CAE data

ZUKEN Portal 2042-3829	<a href="#">URL</a>	<a href="#">Download</a>
------------------------	---------------------	--------------------------

---

### Environmental Product Compliance

#### Compliance Search

Environmental Product Compliance 2042-3829	<a href="#">URL</a>	<a href="#">Download</a>
--	---------------------	--------------------------

Relay module; Nominal input voltage: 24 ... 230 V AC/DC; 4 make contacts; Limiting continuous current: 3 A; Green status indicator; Module width: 25 mm

---

### Installation Notes

Subject to changes. Please also observe the further product documentation!

---

WAGO GmbH & Co. KG  
Hansastr. 27  
32423 Minden  
Phone: +49571 887-0 | Fax: +49571 887-169  
Email: [info.de@wago.com](mailto:info.de@wago.com) | Web: [www.wago.com](http://www.wago.com)

Do you have any questions about our products?  
We are always happy to take your call at +49 (571) 887-44222.