

Features

- 0805 1.0mm SMD LED
- High Brightness
- AllInGaP / InGaN Technology
- Small package
- High reliability
- Clear Lens

Applications

- Consumer Electronics
- Wearables
- Automobile After Market
- Industrial Equipment

Description

The IN-S85CS series is a popular low profile 0805 package with versatile design capabilities. It is a PCB type molding style LED which can be used in various applications.

Recommended Solder Pattern

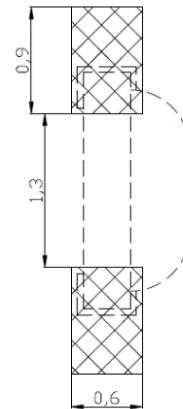
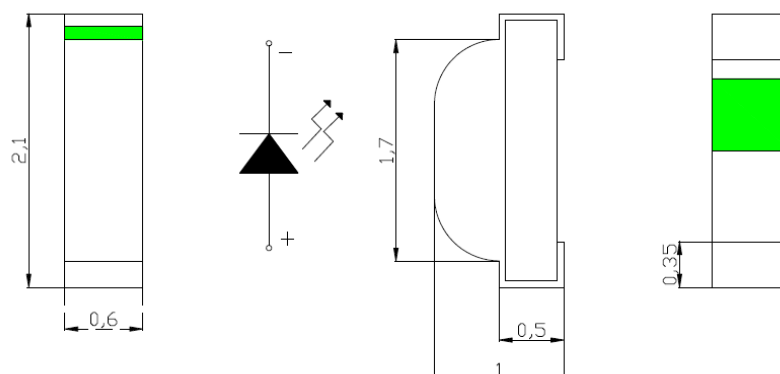

Figure 1. IN-S85CS Solder Pattern

Package Dimensions in mm



Notes.

1. All dimensions are in millimeters.
2. Tolerance is ± 0.1 mm unless otherwise noted

Figure 2. IN-S85CS Package Dimensions

Absolute Maximum Rating at 25°C (Note 1)

Product	Emission Color	P_d (mW)	I_F (mA)	I_{FP}^* (mA)	V_R (V)	T_{OP} (°C)	T_{ST} (°C)
IN-S85CS5YG	Yellow Green	75	25	70	5	-30°C~+85°C	-40°C~+90°C
IN-S85CS5Y	Yellow						
IN-S85CS5A	Amber						
IN-S85CS5R	Red						
IN-S85CS5B	Blue	90	25	100			
IN-S85CS5G	Green						
IN-S85CS5UW	White						

Notes

1. Condition for IFP is pulse of 1/10 duty and 0.1msec width

ESD Precaution

ATTENTION: Electrostatic Discharge (ESD) protection



The symbol above denotes that ESD precaution is needed. ESD protection for GaP and AlGaAs based chips is necessary even though they are relatively safe in the presence of low static-electric discharge. Parts built with AlInGaP, GaN, or/and InGaN based chips are STATIC SENSITIVE devices. ESD precaution must be taken during design and assembly. If manual work or processing is needed, please ensure the device is adequately protected from ESD during the process.

Please be advised that normal static precautions should be taken in the handling and assembly of this device to prevent damage or degradation which may be induced by electrostatic discharge (ESD).

Electrical Characteristics $T_A = 25^\circ\text{C}$ (Note 1)

Product	Emission Color	$I_F(\text{mA})$	$V_F(\text{V})$		$\lambda(\text{nm})$			Viewing Angle	$I_V^*(\text{mcd})$
			min	max	λ_D	λ_P	$\Delta\lambda$	$2\theta_{1/2}$	typ.
IN-S85CS5YG	Yellow Green	5	2.5	3.0	570	574	30	120	12
IN-S85CS5Y	Yellow	5	1.8	2.2	589	582	15	120	35
IN-S85CS5A	Amber	5	1.8	2.2	605	606	15	120	35
IN-S85CS5R	Red	5	1.8	2.4	622	625	20	120	35
IN-S85CS5B	Blue	5	2.6	3.1	470	467	30	120	40
IN-S85CS5G	Green	5	2.5	3.0	525	524	35	120	230
IN-S85CS5UW	White	5	2.6	3.1	X=0.295 Y=0.300	-	-	120	260

Notes

1. Performance guaranteed only under conditions listed in above tables.

Chromaticity Bin (for White only)

Bin Code	CIE-X	CIE-Y	Bin Code	CIE-X	CIE-Y	Bin Code	CIE-X	CIE-Y	Bin Code	CIE-X	CIE-Y
F56	0.3115	0.3391	F78	0.3130	0.3290	G12	0.3144	0.3186	G34	0.3161	0.3059
	0.3099	0.3509		0.3115	0.3391		0.3130	0.3290		0.3144	0.3186
	0.3196	0.3602		0.3205	0.3481		0.3213	0.3373		0.3221	0.3261
	0.3205	0.3481		0.3213	0.3373		0.3221	0.3261		0.3231	0.3120
E56	0.3028	0.3304	E78	0.3048	0.3207	F12	0.3068	0.3113	F34	0.3093	0.2993
	0.3005	0.3415		0.3028	0.3304		0.3048	0.3207		0.3068	0.3113
	0.3099	0.3509		0.3115	0.3391		0.3130	0.3290		0.3144	0.3186
	0.3115	0.3391		0.3130	0.3290		0.3144	0.3186		0.3161	0.3059
D56	0.2937	0.3312	D78	0.2962	0.3220	E12	0.2984	0.3133	E34	0.3009	0.3042
	0.2962	0.3220		0.2984	0.3133		0.3009	0.3042		0.3037	0.2937
	0.3028	0.3304		0.3048	0.3207		0.3068	0.3113		0.3093	0.2993
	0.3005	0.3415		0.3028	0.3304		0.3048	0.3207		0.3068	0.3113
C56	0.2870	0.3210	C78	0.2920	0.3060	D12	0.2950	0.2970	D34	0.2950	0.2970
	0.2937	0.3312		0.2895	0.3134		0.2920	0.3060		0.2980	0.2880
	0.2962	0.3220		0.2962	0.3220		0.2984	0.3133		0.3037	0.2937
	0.2895	0.3134		0.2984	0.3133		0.3009	0.3042		0.3009	0.3042
C1	0.2830	0.3050	C2	0.2863	0.2978	C3	0.2895	0.2905	C4	0.2928	0.2833
	0.2863	0.2978		0.2895	0.2905		0.2928	0.2833		0.2977	0.2891
	0.2923	0.3052		0.2950	0.2970		0.2977	0.2891		0.3003	0.2812
	0.2895	0.3134		0.2923	0.3052		0.2950	0.2970		0.2960	0.2760
AX	0.2960	0.2760	B5	0.2735	0.2860	B6	0.2772	0.2800	B7	0.2808	0.2740
	0.2992	0.2687		0.2772	0.2800		0.2808	0.2740		0.2844	0.2680
	0.3029	0.2733		0.2863	0.2978		0.2895	0.2905		0.2928	0.2833
	0.3003	0.2812		0.2830	0.3050		0.2863	0.2978		0.2895	0.2905
B8	0.2844	0.2680	AW	0.288	0.262	B1	0.2640	0.2670	B2	0.2720	0.2575
	0.2928	0.2833		0.2916	0.256		0.2680	0.2623		0.2680	0.2623
	0.2960	0.2760		0.2992	0.2687		0.2772	0.2800		0.2772	0.2800
	0.2880	0.2620		0.296	0.276		0.2735	0.2860		0.2808	0.2740
B3	0.2720	0.2575	B4	0.2760	0.2528	AU	0.28	0.248	A5	0.2545	0.2480
	0.2760	0.2528		0.2844	0.2680		0.284	0.2432		0.2589	0.2445
	0.2844	0.2680		0.2880	0.2620		0.2916	0.256		0.2680	0.2623
	0.2808	0.2740		0.2800	0.2480		0.288	0.262		0.2640	0.2670
A6	0.2589	0.2445	A7	0.2677	0.2375	A8	0.2720	0.2340	AT	0.272	0.234
	0.2633	0.2410		0.2633	0.2410		0.2677	0.2375		0.2763	0.2305
	0.2720	0.2575		0.2720	0.2575		0.2760	0.2528		0.284	0.2432
	0.2680	0.2623		0.2760	0.2528		0.2800	0.2480		0.28	0.248
A2	0.2497	0.2267	A3	0.2593	0.2223	A4	0.2640	0.2200	AS	0.264	0.22
	0.2589	0.2445		0.2677	0.2375		0.2593	0.2223		0.2687	0.2177
	0.2633	0.2410		0.2633	0.2410		0.2677	0.2375		0.2763	0.2305
	0.2545	0.2245		0.2545	0.2245		0.2720	0.2340		0.272	0.234

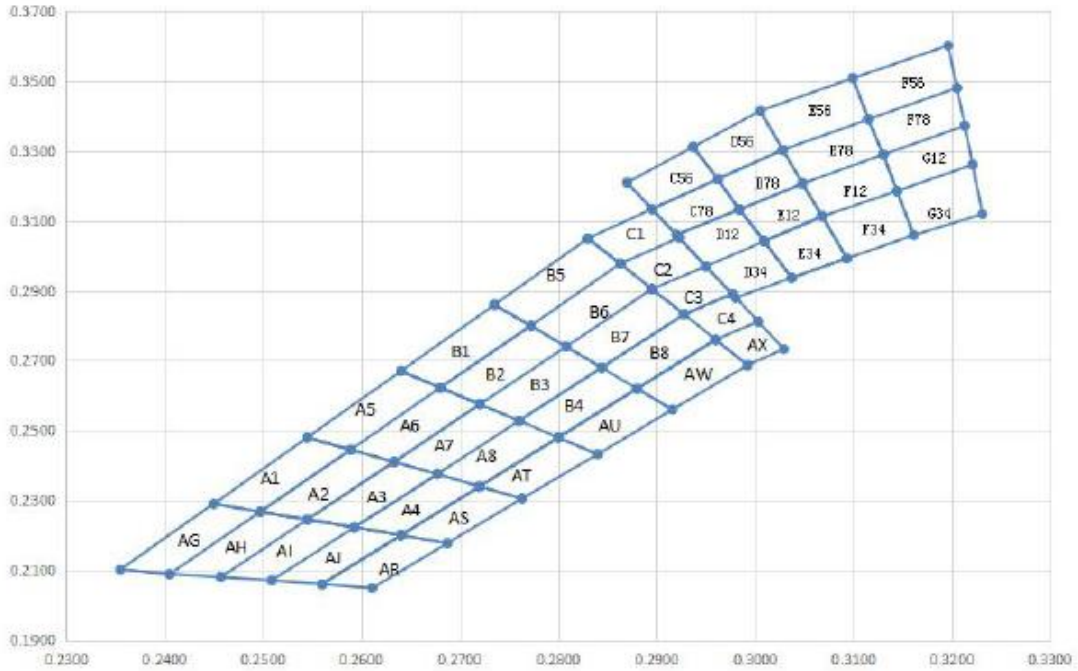

Typical Characteristic Curves – YG

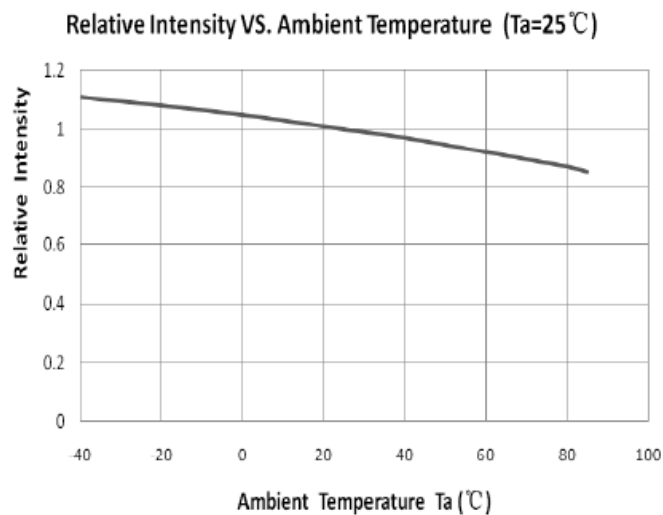
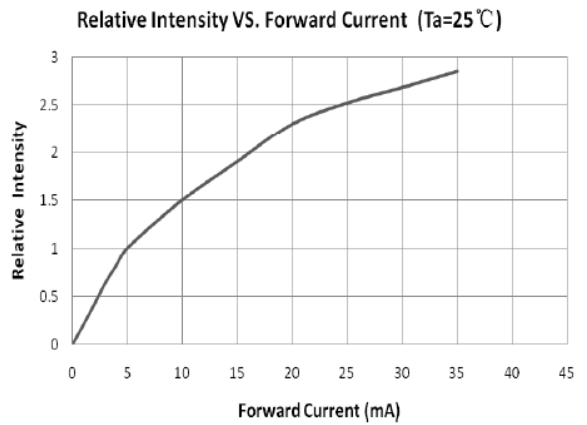
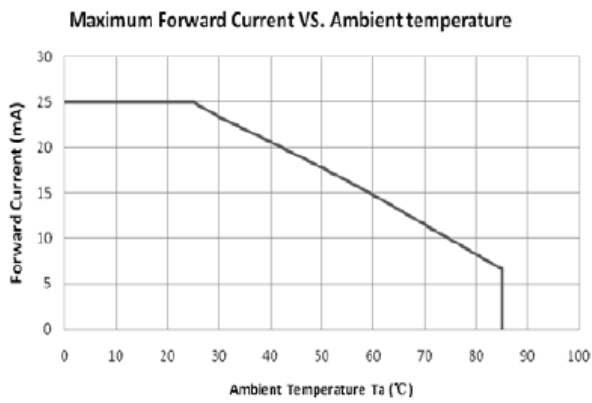
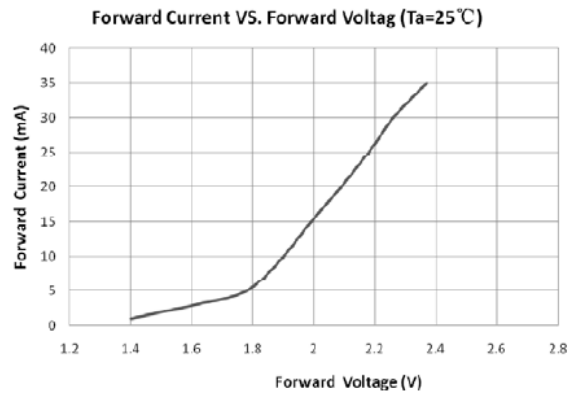
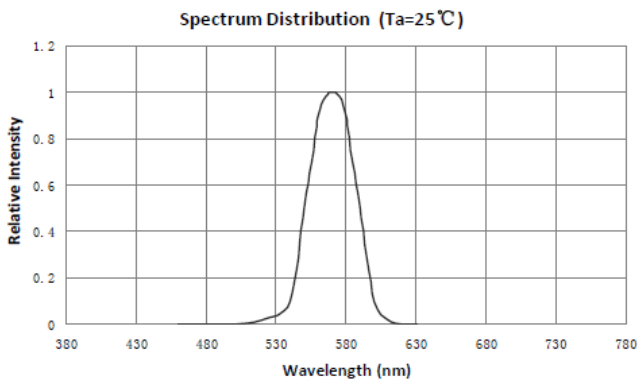

Typical Characteristic Curves – Y

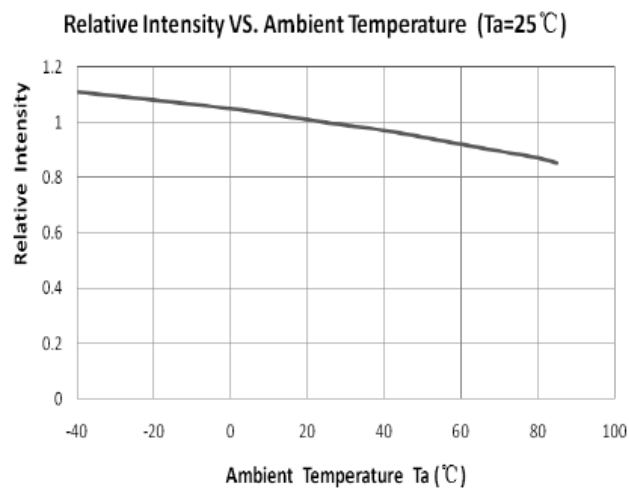
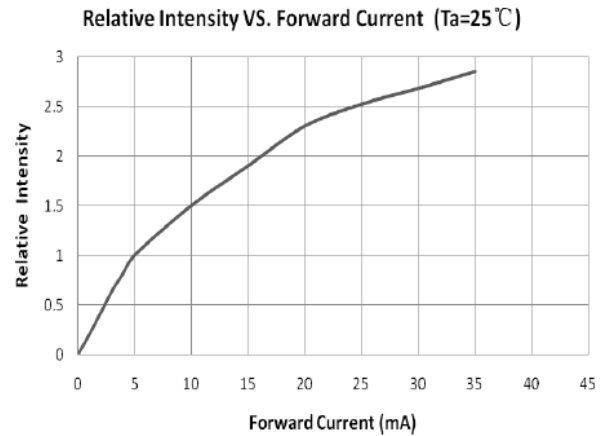
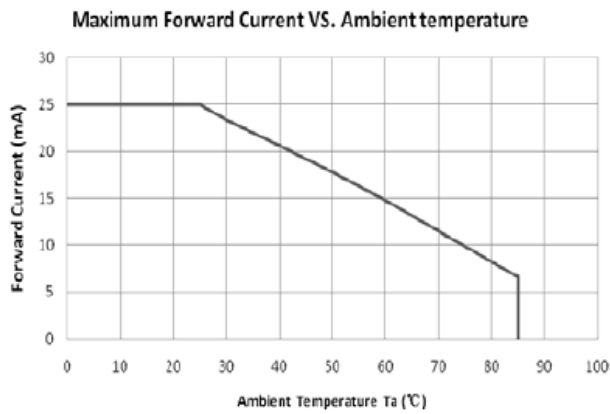
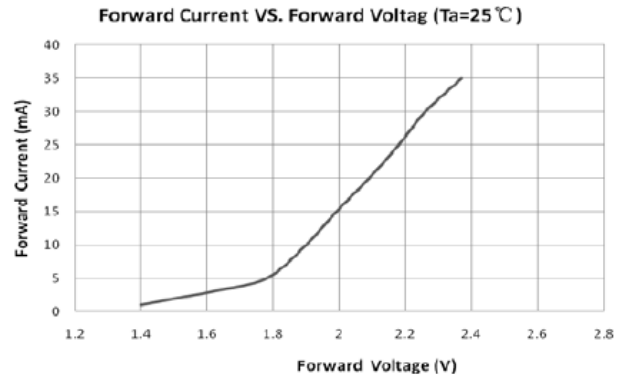
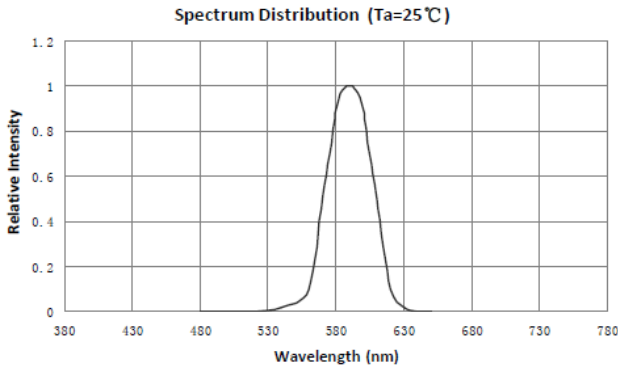

Typical Characteristic Curves – A

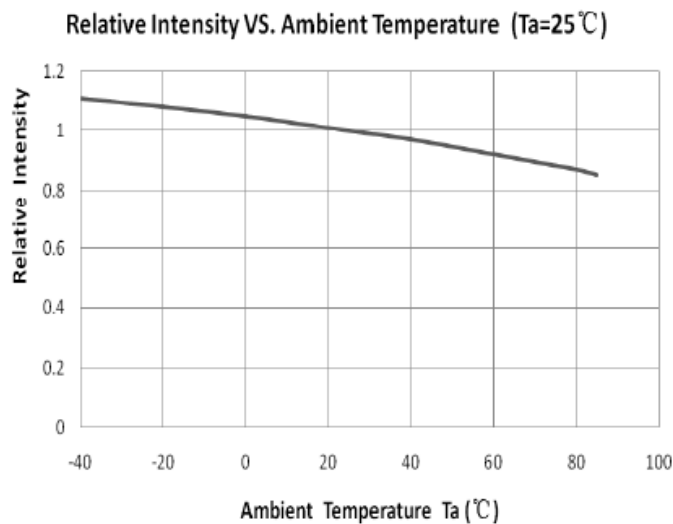
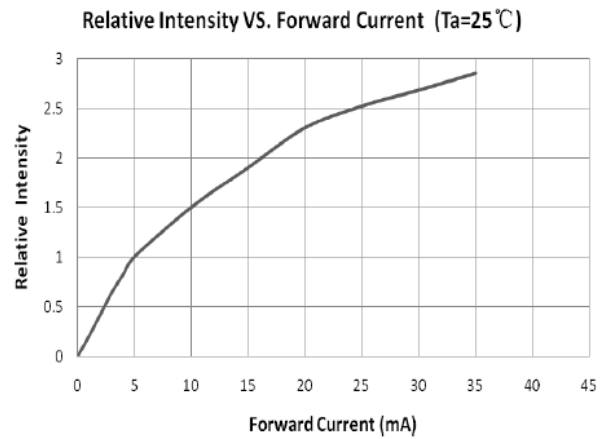
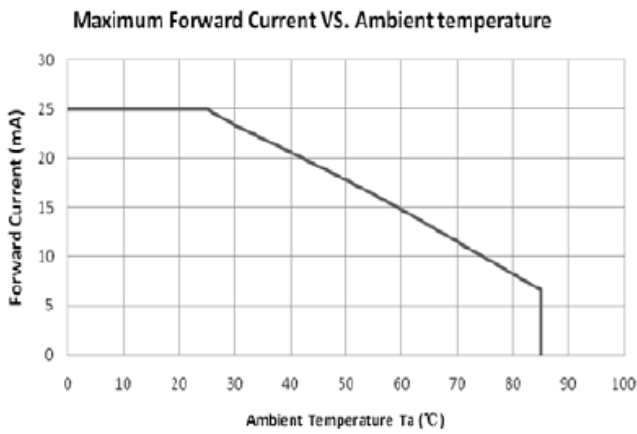
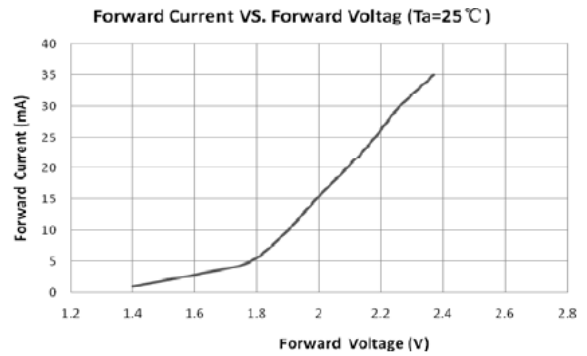
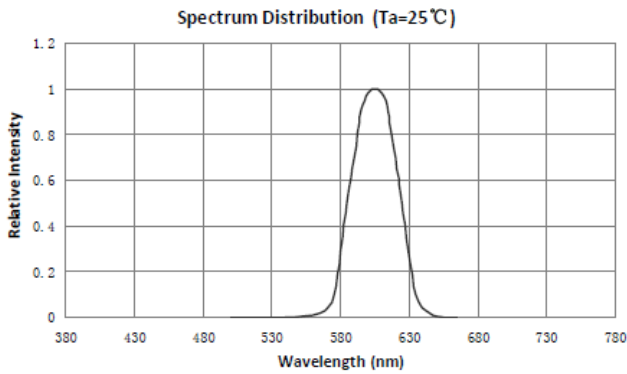

Typical Characteristic Curves – R

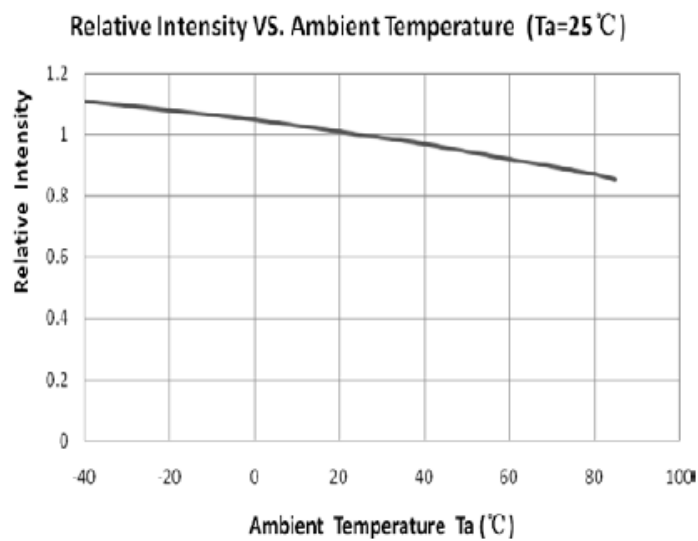
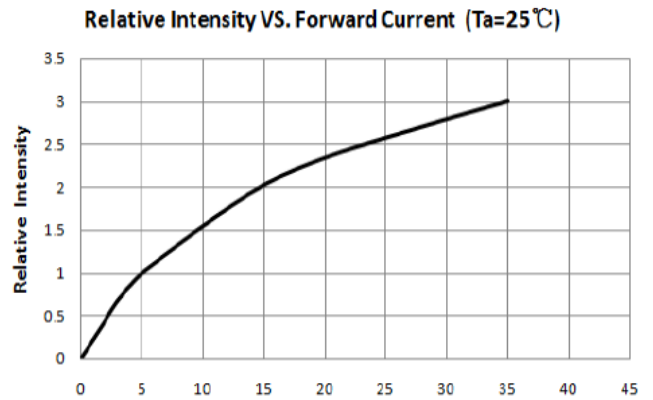
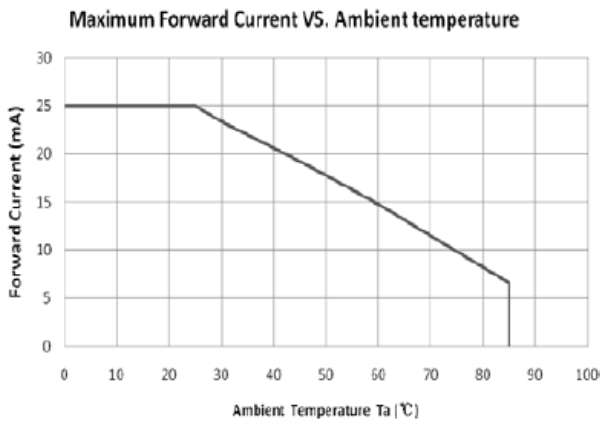
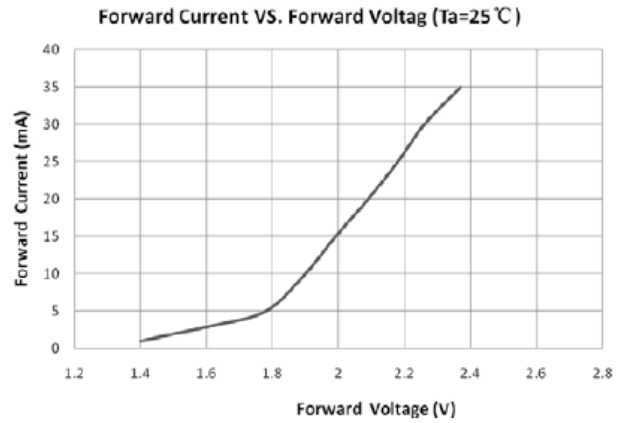
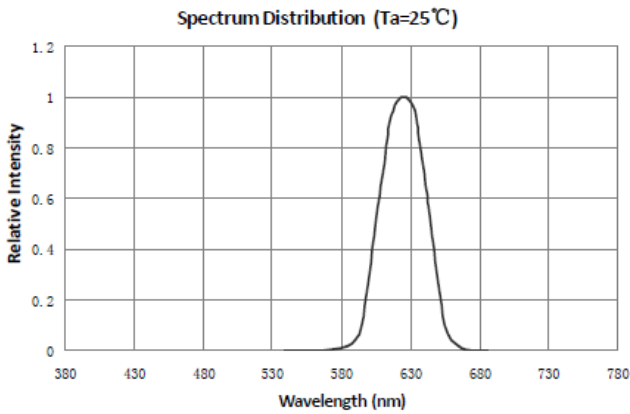

Typical Characteristic Curves – B

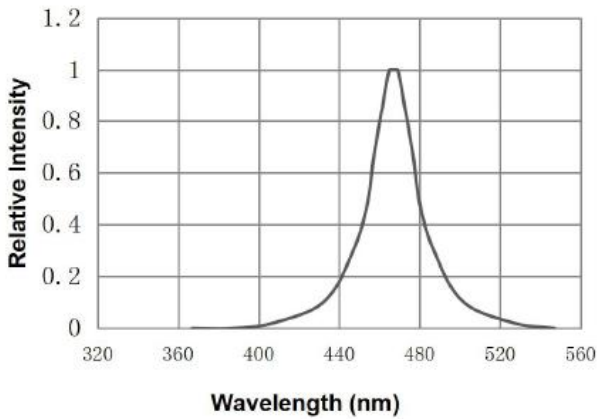
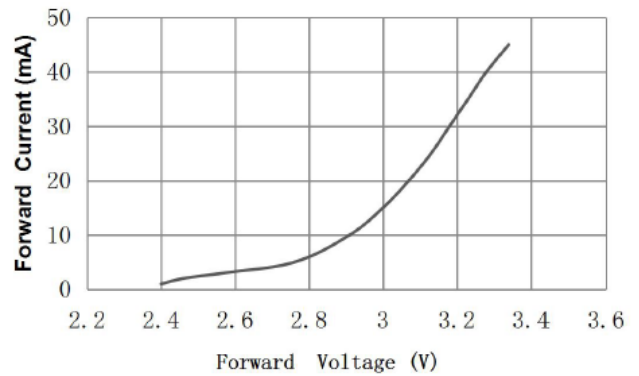
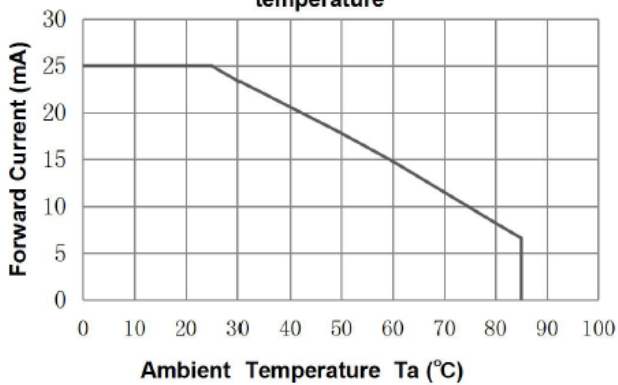
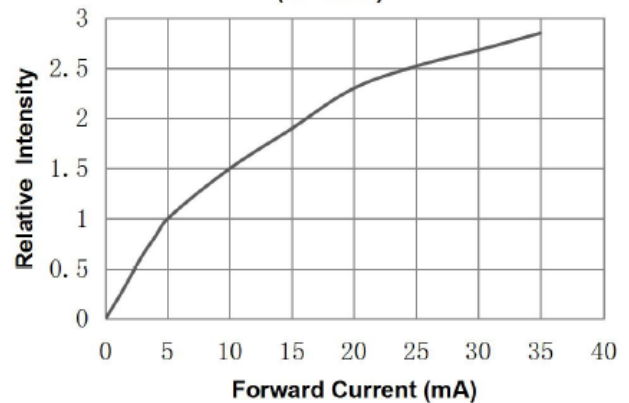
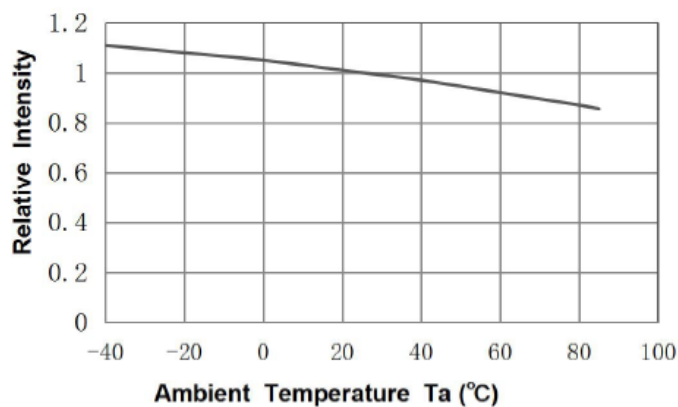
Spectrum Distribution (Ta=25°C)

Forward Current VS. Forward Voltage (Ta=25°C)

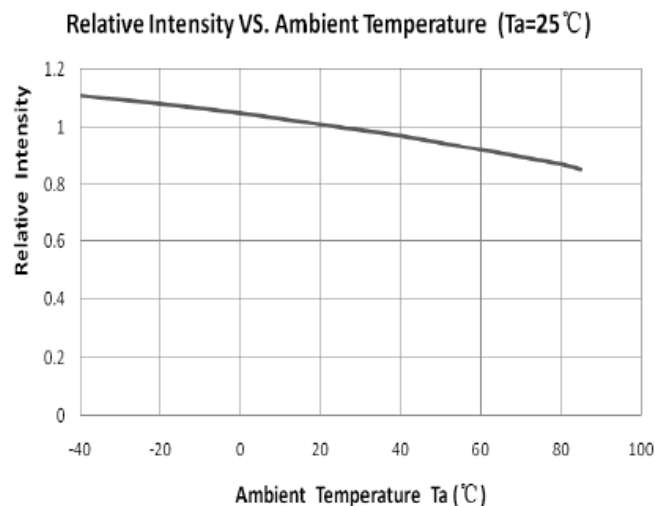
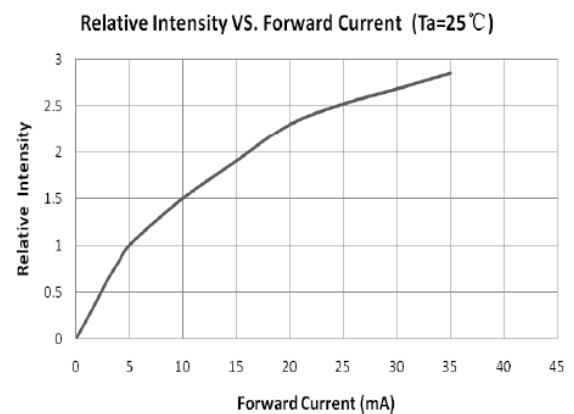
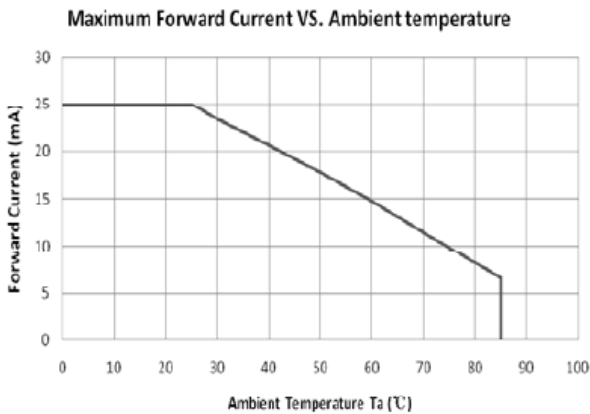
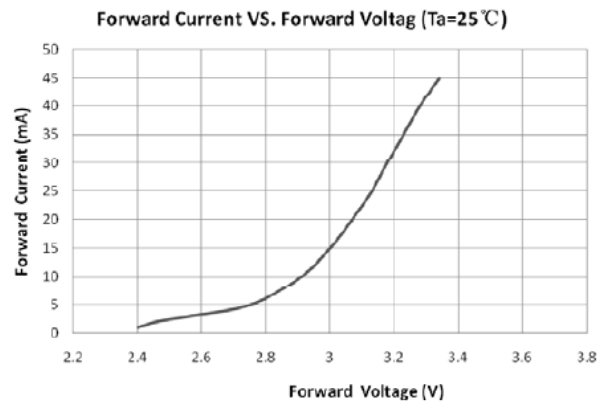
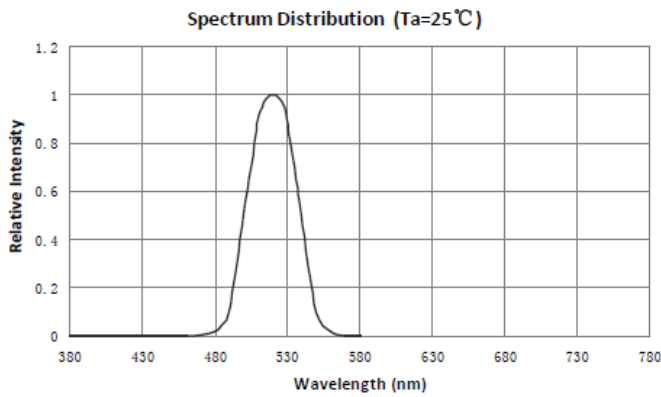
Maximum Forward Current VS. Ambient temperature

Relative Intensity VS. Forward Current (Ta=25°C)

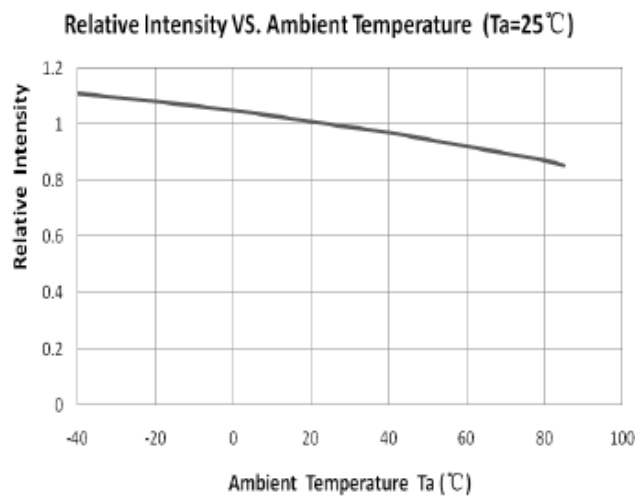
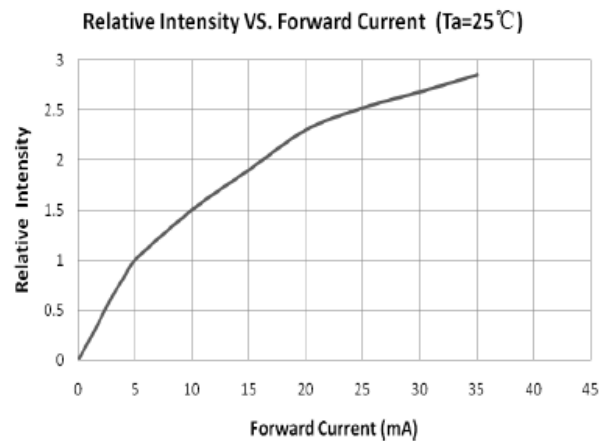
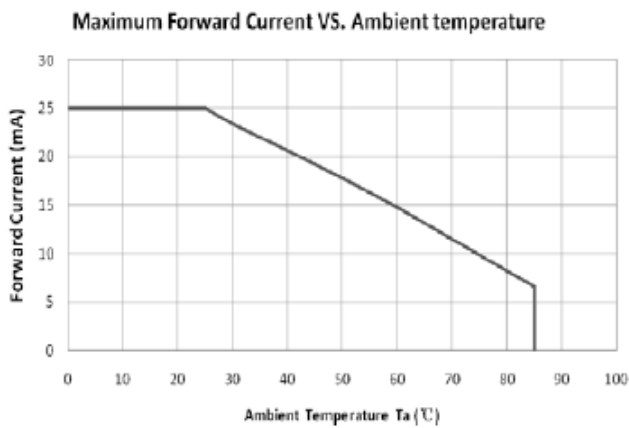
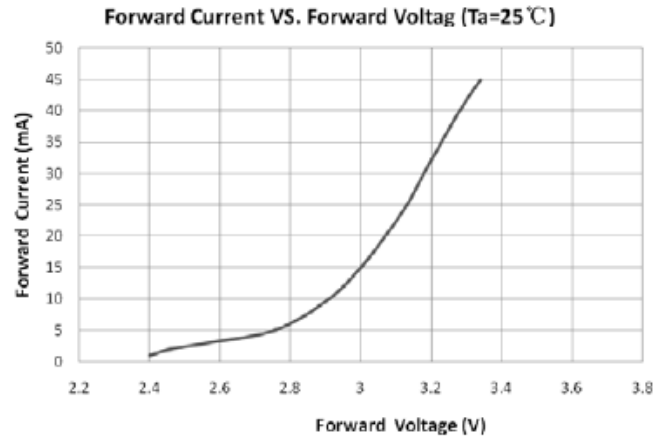
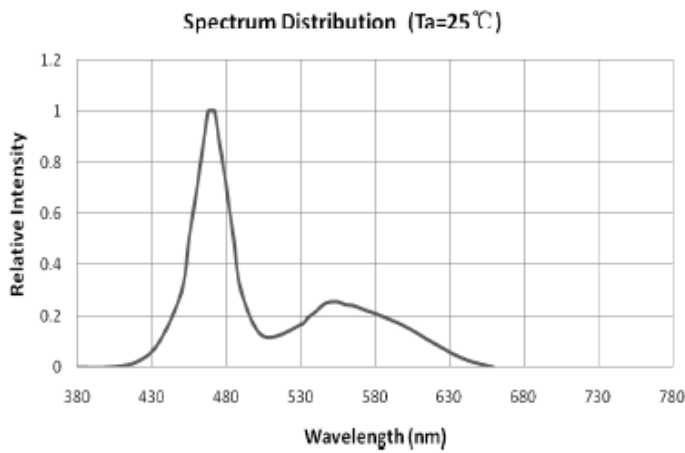
Relative Intensity VS. Ambient Temperature (Ta=25°C)

Typical Characteristic Curves – G



Typical Characteristic Curves – UW



Typical Characteristic Curves – Radiation Pattern

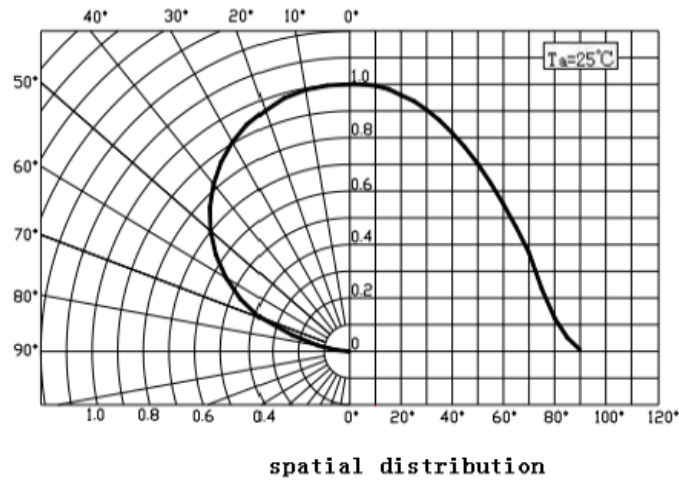

Ordering Information

Product	Emission Color	Technology	Test Current I_F (mA)	Luminous Intensity I_V (mcd) (Typ.)	Forward Voltage V_F (V) (Typ.)	Orderable Part Number
IN-S85CS5YG	Yellow Green	AllnGaP	5	12	2.0	IN-S85CS5YG
IN-S85CS5Y	Yellow	AllnGaP	5	35	2.0	IN-S85CS5Y
IN-S85CS5A	Amber	AllnGaP	5	35	2.0	IN-S85CS5A
IN-S85CS5R	Red	AllnGaP	5	35	2.0	IN-S85CS5R
IN-S85CS5B	Blue	InGaN	5	40	2.8	IN-S85CS5B
IN-S85CS5G	Green	InGaN	5	230	2.8	IN-S85CS5G
IN-S85CS5UW	White	InGaN	5	260	2.8	IN-S85CS5UW

Label Specifications

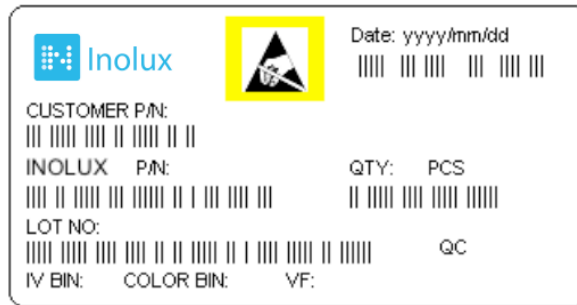

Inolux P/N:

I	N	-	S	8	5	C	S	5		YG	-	-	-	-	-
Inolux SMD			Material	Package		Variation	Orientation	Current	Lens	Color		Customized Stamp-off			
			S = PCB Type	85C = 2.1 x 0.6 x 1.0 mm			S = Side Mount	5-5mA	(Blank) = Clear U = Diffused	YG=470nm Y=589nm A=605nm R=622nm B=470nm G=525nm W=White		Customized Stamp-off			

Lot No.:

Z	2	0	1	7	01	24	001
Internal Tracker	Year (2017, 2018,)				Month	Date	Serial

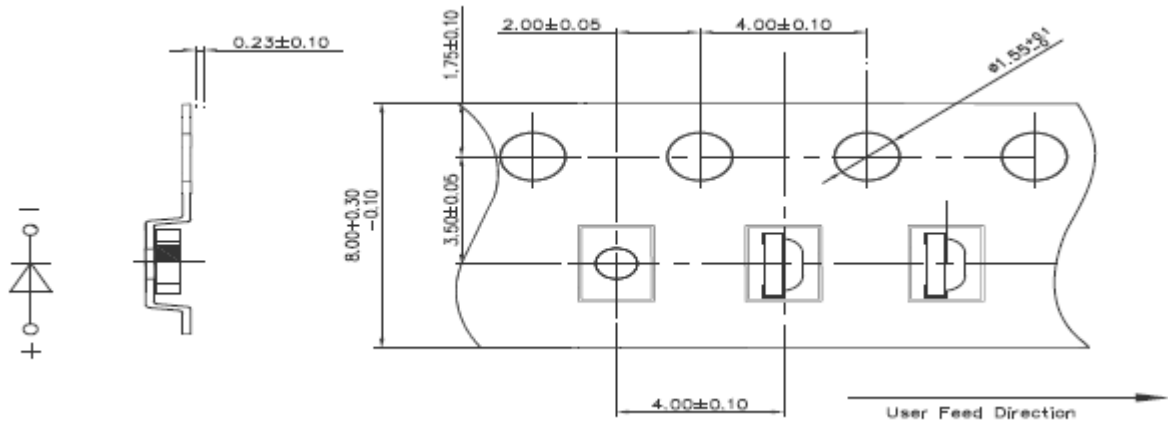
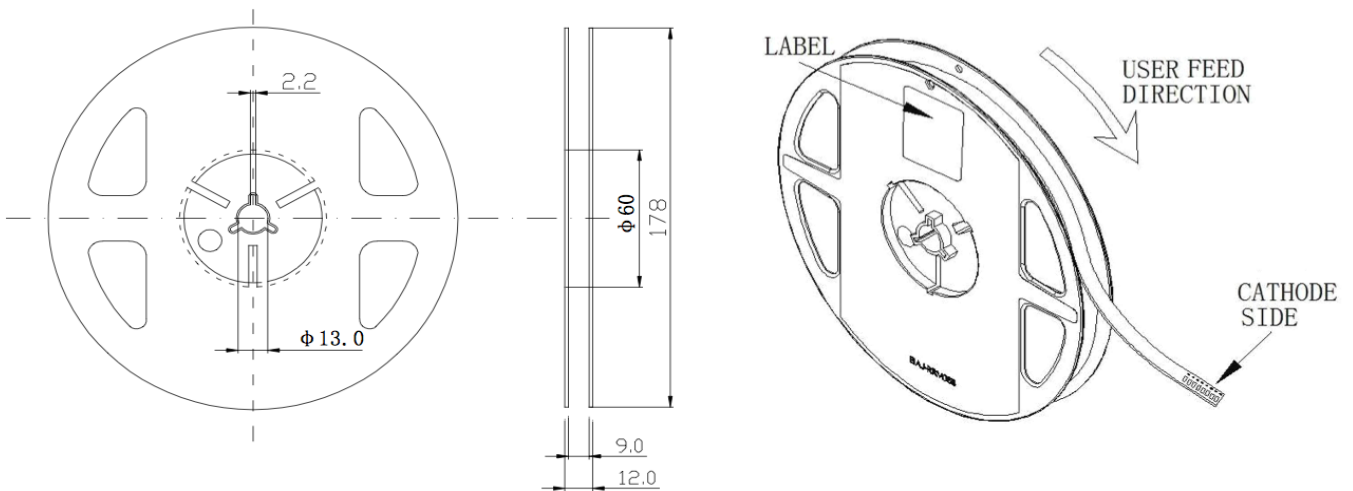
Packaging Information: 3000pcs Per Reel
Tape Dimension

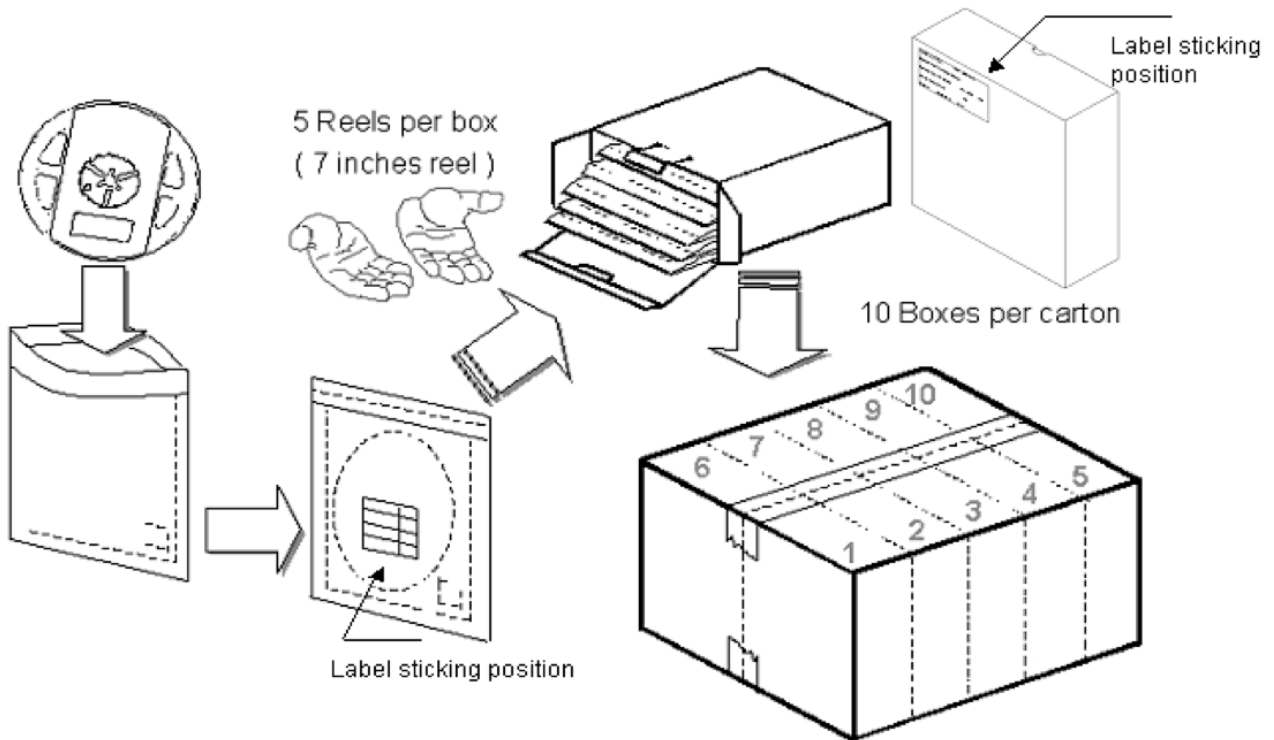
Reel Dimension

Packing Dimension

5 boxes per carton are available depending on shipment quantity.

	Specification	Material	Quantity
Carrier tape	Per EIA 481-1A specs	Conductive black tape	3000pcs per reel
Reel	Per EIA 481-1A specs	Conductive black	
Label	IN standard	Paper	
Packing bag	220x240mm	Aluminum laminated bag/ no-zipper	One reel per bag
Carton	IN standard	Paper	Non-specified

Others:

Each immediate box consists of 5 reels. The 5 reels may not necessarily have the same lot number or the same bin combinations of I_v , λ_D and V_f . Each reel has a label identifying its specification; the immediate box consists of a product label as well.

Dry Pack

All SMD optical devices are **MOISTURE SENSITIVE**. Avoid exposure to moisture at all times during transportation or storage. Every reel is packaged in a moisture protected anti-static bag. Each bag is properly sealed prior to shipment.

Upon request, a humidity indicator will be included in the moisture protected anti-static bag prior to shipment.

The packaging sequence is as follows:

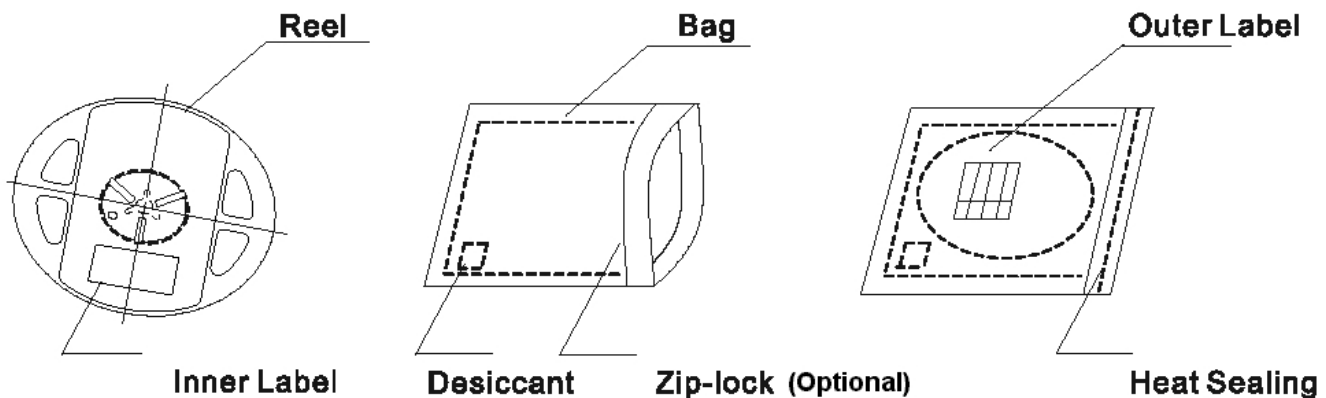

Reflow Soldering

- Recommended tin glue specifications: melting temperature in the range of 178~192 °C
- The recommended reflow soldering profile is as follows (temperatures indicated are as measured on the surface of the LED resin):

Lead-free Solder Profile

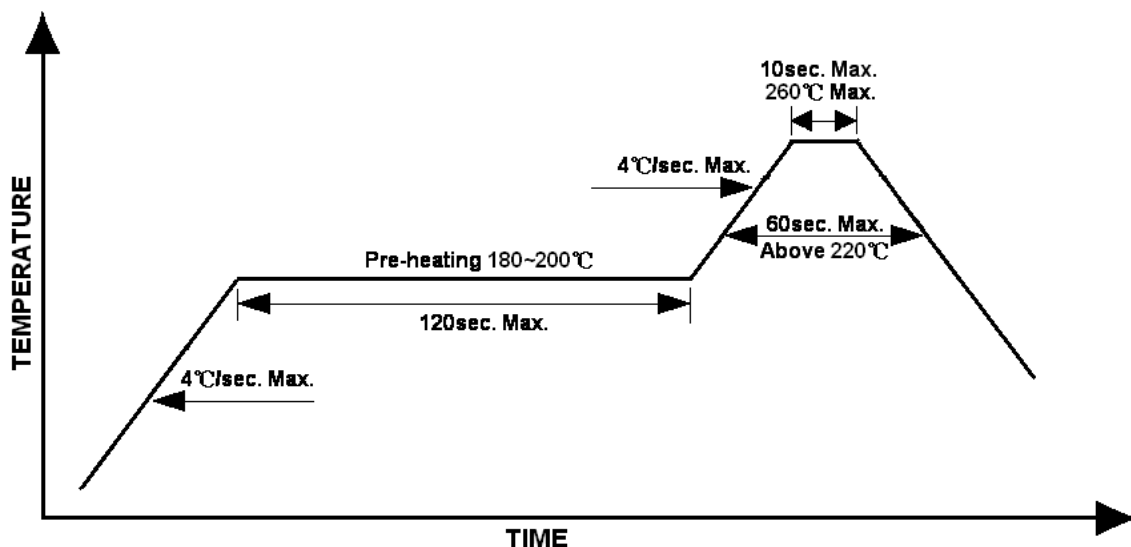

Precautions

- Avoid exposure to moisture at all times during transportation or storage.
- Anti-Static precaution must be taken when handling GaN, InGaN, and AlInGaP products.
- It is suggested to connect the unit with a current limiting resistor of the proper size. Avoid applying a reverse voltage.
- Avoid operation beyond the limits as specified by the absolute maximum ratings.
- Avoid direct contact with the surface through which the LED emits light.
- If possible, assemble the unit in a clean room or dust-free environment.

Reworking

- Rework should be completed within 5 seconds under 260 °C.
- The iron tip must not come in contact with the copper foil.
- Twin-head type is preferred.

Cleaning

Following are cleaning procedures after soldering:

- An alcohol-based solvent such as isopropyl alcohol (IPA) is recommended.
- Temperature x Time should be 50°C x 30sec. or <30°C x 3min
- Ultra sonic cleaning: < 15W/ bath; bath volume ≤ 1liter
- Curing: 100 °C max, <3min

Cautions of Pick and Place

- Avoid stress on the resin at elevated temperature.
- Avoid rubbing or scraping the resin by any object.
- Electro-static may cause damage to the component. Please ensure that the equipment is properly grounded. Use of an ionizer fan is recommended.

Reliability

Item	Frequency/ lots/ samples/ failures	Standards Reference	Conditions
Precondition	For all reliability monitoring tests according to JEDEC Level 2	J-STD-020	1.) Baking at 85°C for 24hrs 2.) Moisture storage at 85°C/ 60% R.H. for 168hrs
Solderability	1Q/ 1/ 22/ 0	JESD22-B102-B And CNS-5068	Accelerated aging 155°C/ 24hrs Tinning speed: 2.5+0.5cm/s Tinning: A: 215°C/ 3+1s or B: 260°C/ 10+1s
Resistance to soldering heat		CNS-5067	Dipping soldering terminal only Soldering bath temperature A: 260+/-5°C; 10+/-1s B: 350+/-10°C; 3+/-0.5s
Operating life test	1Q/ 1/ 40/ 0	CNS-11829	1.) Precondition: 85°C baking for 24hrs 85°C/ 60%R.H. for 168hrs 2.) Tamb25°C; IF=20mA; duration 1000hrs
High humidity, high temperature bias	1Q/ 1/ 45/ 0	JESD-A101-B	Tamb: 85°C Humidity: 85% R.H., IF=5mA Duration: 1000hrs
High temperature bias	1Q/ 1/ 20	IN specs.	Tamb: 55°C IF=20mA Duration: 1000hrs
Pulse life test	1Q/ 1/ 40/ 0		Tamb25°C, If=20mA,, Ip=100mA, Duty cycle=0.125 (tp=125 μ s,T=1sec) Duration 500hrs)
Temperature cycle	1Q/ 1/ 76/ 0	JESD-A104-A IEC 68-2-14, Nb	A cycle: -40 degree C 15min; +85 degree C 15min Thermal steady within 5 min.. 300 cycles 2 chamber/ Air-to-air type
High humidity storage test	1Q/ 1/ 40/ 0	CNS-6117	60+3°C 90+5/-10% R.H. for 500hrs
High temperature storage test	1Q/ 1/ 40/ 0	CNS-554	100+10°C for 500hrs
Low temperature storage test	1Q/ 1/ 40/ 0	CNS-6118	-40+5°C for 500hrs

Revision History

Changes since last revision	Page	Version No.	Revision Date
Initial Release		V1.0	04-06-2020

DISCLAIMER

INOLUX reserves the right to make changes without further notice to any products herein to improve reliability, function or design. INOLUX does not assume any liability arising out of the application or use of any product or circuit described herein; neither does it convey any license under its patent rights, nor the rights of others.

LIFE SUPPORT POLICY

INOLUX's products are not authorized for use as critical components in life support devices or systems without the express written approval of the President of INOLUX or INOLUX CORPORATION. As used herein:

1. Life support devices or systems are devices or systems which, (a) are intended for surgical implant into the body, or (b) support or sustain life, and (c) whose failure to perform when properly used in accordance with instructions for use provided in the labeling, can be reasonably expected to result in a significant injury of the user.
2. A critical component in any component of a life support device or system whose failure to perform can be reasonably expected to cause the failure of the life support device or system, or to affect its safety or effectiveness.