

TMC4361-LA DATASHEET

Cost-effective S-ramp motion controller with servo option for stepper motors. Optimized for high velocities. SPI and Step/Dir interfaces to motor driver and encoder interface for closed loop operation.



APPLICATIONS

Textile, Sewing Machines
 Factory Automation
 Lab Automation
 Medical
 Office Automation
 Printer and Scanner
 CCTV, Security
 ATM, Cash recycler
 POS
 Pumps and Valves
 Heliostat Controller
 CNC Machines

FEATURES AND BENEFITS

3.3V or 5V operation

SPI interface for μC with easy-to-use protocol

SPI interface for SPI motor drivers

Step/Dir interface for Step/Dir motor drivers

Clock frequency 4.2 MHz up to 32 MHz

Encoder interface: incremental ABN and serial SSI/SPI

2x ref.-switch input

Servo drive option

S-shaped or linear velocity ramps, optimally calculated

On-the-fly change of target motion parameters

Low power operation using clock gating technology

Different current levels related to the motion profile status

Programmable microstep table

Read-out option for all important motion parameters

Compact Size 6x6 mm² QFN40 package

Directly controls TMC23x, TMC24x, and TMC26x motor driver

DESCRIPTION

The TMC4361 is intended for applications where a fast and jerk-limited motion profile is desired. This motion controller adds to any microcontroller with SPI interface. It supports S-shaped, trapezoid, and rectangle ramps. With encoder, the TMC4361 allows for an extremely quick and precise positioning. Its servo features provide step-loss protection, energy efficiency, and target positioning with stepper typical stability. Standard SPI and STEP/DIR interfaces to the motor driver simplify communication.

High end features, no software effort and the small form factor of the TMC4361 enable miniaturized designs with low external component count for cost-effective and highly competitive solutions.

BLOCK DIAGRAM

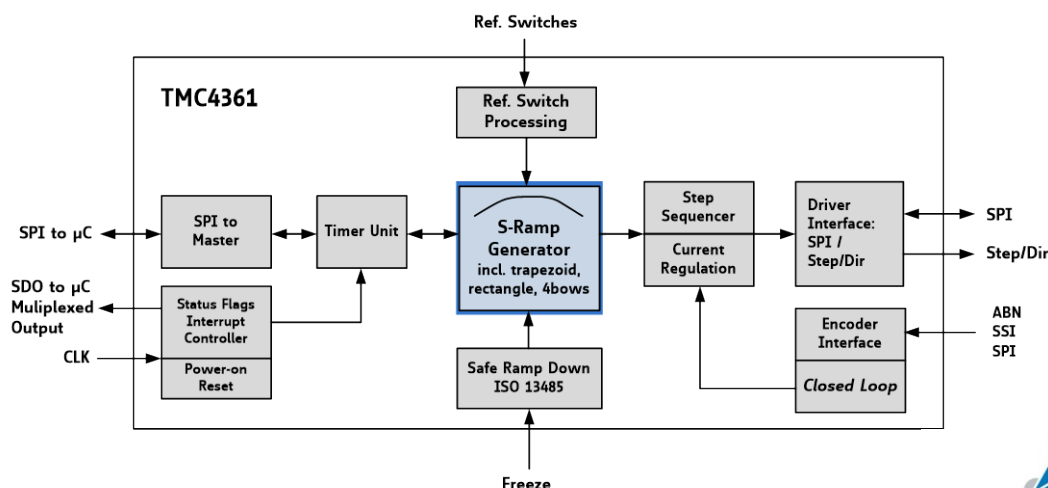

HIGH-END SOLUTION: VELOCITY MEETS PRECISION

The TMC4361 is a miniaturized high performance stepper motor controller with an outstanding cost-performance ratio. It is designed for high volume as well as for demanding industrial motion control applications. The TMC4361 is equipped with an SPI™ host interface (SPI is trademark of Motorola) with easy-to-use protocol and three driver interfaces (SPI, Step/Dir, and PWM) for addressing various stepper motor driver types. The TMC4361 scores with its unique servo drive features, high integration and a versatility that covers a wide spectrum of applications, motor sizes, and encoder types.

For a comfortable handling, the chip works with real world units. Extensive support at the chip, board, and software levels enables rapid design cycles and fast time-to-market with competitive products. High energy efficiency delivers further cost savings.

S-SHAPED VELOCITY PROFILE

This outstanding ramp profile minimizes jerk. Seven segments of the ramp allow for an optimum adaptation of the velocity profile to the customer specific application requirements. High torque with high velocities can be reached by calibrating the bows of the ramp in a way that the acceleration value near V_{MAX} is reduced in parallel to the available motor torque.

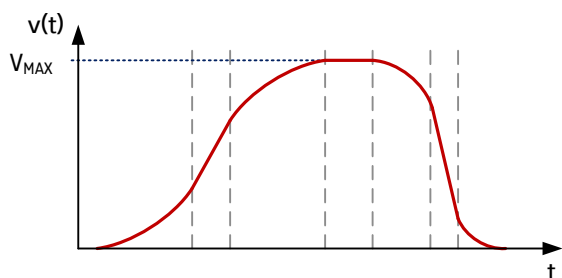

COMPACT DESIGN FOR RELIABLE CLOSED LOOP OPERATION

BENEFIT FROM HIGH VELOCITIES COMBINED WITH EXTREMELY HIGH PRECISION!

Closed loop operation is an optimum choice in case a dynamic and reliable drive without step-loss or motor stall is desired. The controller IC monitors the encoder values nonstop and uses them for a sophisticated motor field control.

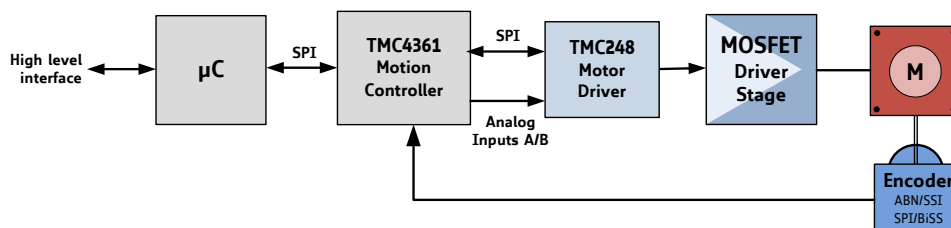

COMPACT DESIGN FOR RELIABLE OPERATION USING STOP SWITCHES

The TMC4361 offers a left and a right stop switch in hardware as well as a home switch. Further, it provides two virtual stop switches which can trigger stop slopes in case the related virtual stop switch microstep position is reached.

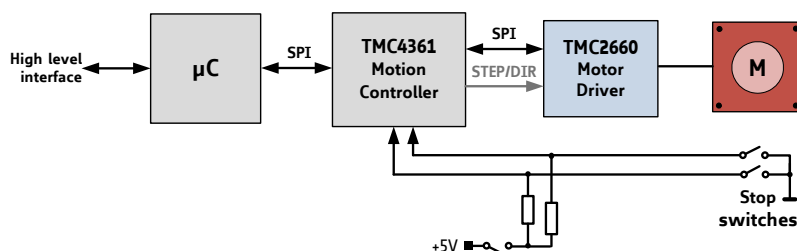

ORDER CODES

Order code	Description	Size
TMC4361-LA	Motion controller with servo and dcStep features, QFN40	6 x 6 mm ²

Table of Contents

1	PRINCIPLES OF OPERATION	4	14.2	INCREMENTAL ABN ENCODER	50
1.1	DRIVE CONCEPTS AND CONTROL MODES	4	14.3	ABSOLUTE ENCODER	52
1.2	KEY CONCEPTS	5	14.4	CONTROL VIA ENCODER FEEDBACK	56
1.3	OVERVIEW INTERFACES	5	14.5	ENCODER MISALIGNMENTS	61
1.4	STEP FREQUENCIES	6	15	SERIAL ENCODER OUTPUT UNIT	62
1.5	MOVING THE MOTOR	6	15.1	PROVIDING SSI OUTPUT DATA	62
1.6	STATUS FLAGS, EVENTS, AND INTERRUPTS	7	16	CLK GATING	63
2	PIN ASSIGNMENTS	8	16.1	CLOCK GATING AND WAKE-UP	63
2.1	PACKAGE OUTLINE	8	17	REGISTERS AND SWITCHES	65
2.2	SIGNAL DESCRIPTION	8	17.1	GENERAL CONFIGURATION	65
3	SAMPLE CIRCUITS	10	17.2	REFERENCE SWITCH CONFIGURATION	67
4	NOTES	11	17.3	START SWITCH CONFIGURATION	69
5	SPI CONTROL INTERFACE	12	17.4	INPUT FILTER CONFIGURATION	70
5.1	SPI DATAGRAM STRUCTURE	12	17.5	SPI-OUT CONFIGURATION	71
5.2	SPI SIGNALS	13	17.6	CURRENT CONFIGURATION	73
5.3	TIMING	14	17.7	CURRENT SCALE VALUES	73
6	INPUT FILTERING	15	17.8	ENCODER SIGNAL CONFIGURATION	74
6.1	INPUT FILTER CONFIGURATION	15	17.9	SERIAL ENCODER DATA IN	76
7	STATUS FLAGS & EVENTS	17	17.10	SERIAL ENCODER DATA OUT	76
7.1	STATUS FLAGS	17	17.11	MOTOR DRIVER SETTINGS	76
7.2	STATUS EVENTS & SPI STATUS & INTERRUPTS	17	17.12	EVENT SELECTION REGISTERS	76
8	RAMP GENERATOR	19	17.13	STATUS EVENT REGISTER	77
8.1	STEP/DIR OUTPUT CONFIGURATION	19	17.14	STATUS FLAG REGISTER	78
8.2	RAMP MODES AND TYPES	20	17.15	VARIOUS CONFIGURATION REGISTERS	79
9	REFERENCE SWITCHES	25	17.16	RAMP GENERATOR REGISTERS	80
9.1	STOPL AND STOPR	25	17.17	TARGET AND COMPARE REGISTERS	82
9.2	VIRTUAL STOP SWITCHES	26	17.18	FREEZE REGISTER	83
9.3	HOME REFERENCE	27	17.19	CLOCK GATING ENABLE REGISTER	83
9.4	CYCLIC MOVEMENT TO <i>XTARGET</i>	28	17.20	ENCODER REGISTERS	84
9.5	TARGET REACHED / POSITION COMPARISON	28	17.21	PID AND CLOSED LOOP REGISTERS	85
10	RAMP TIMING & SYNCHRONIZATION	29	17.22	MISC REGISTERS	86
10.1	START SIGNAL GENERATION	29	17.23	TRANSFER REGISTERS	87
10.2	TARGET PIPELINE	33	17.24	SINLUT REGISTERS	87
11	SERIAL DATA OUTPUT	34	18	ABSOLUTE MAXIMUM RATINGS	88
11.1	SINE WAVE LOOK-UP TABLE	35	19	ELECTRICAL CHARACTERISTICS	88
11.2	SPI OUTPUT PARAMETERS	38	19.1	DC CHARACTERISTICS OPERATING CONDITIONS	88
11.3	CURRENT DATAGRAMS	39	19.2	POWER DISSIPATION	88
11.4	TMC MOTOR DRIVER	40	19.3	GENERAL IO TIMING PARAMETERS	89
11.5	OTHER DRIVER CHIPS	43	20	LAYOUT EXAMPLE	90
11.6	CURRENT SCALING & RAMP STATUS	44	21	PACKAGE MECHANICAL DATA	92
12	NFREEZE: EMERGENCY-STOP	47	21.1	DIMENSIONAL DRAWINGS	92
12.1	FREEZE FUNCTION CONFIGURATION	47	21.2	PACKAGE CODES	93
13	CONTROLLED PWM OUTPUT	48	22	DISCLAIMER	93
13.1	PWM OUTPUT GENERATION	48	23	ESD SENSITIVE DEVICE	93
14	DECODER UNIT & CLOSED LOOP	49	24	TABLE OF FIGURES	94
14.1	GENERAL ENCODER INTERFACE	50	25	REVISION HISTORY	95
			25.1	DOCUMENT REVISIONS	95

1 Principles of Operation

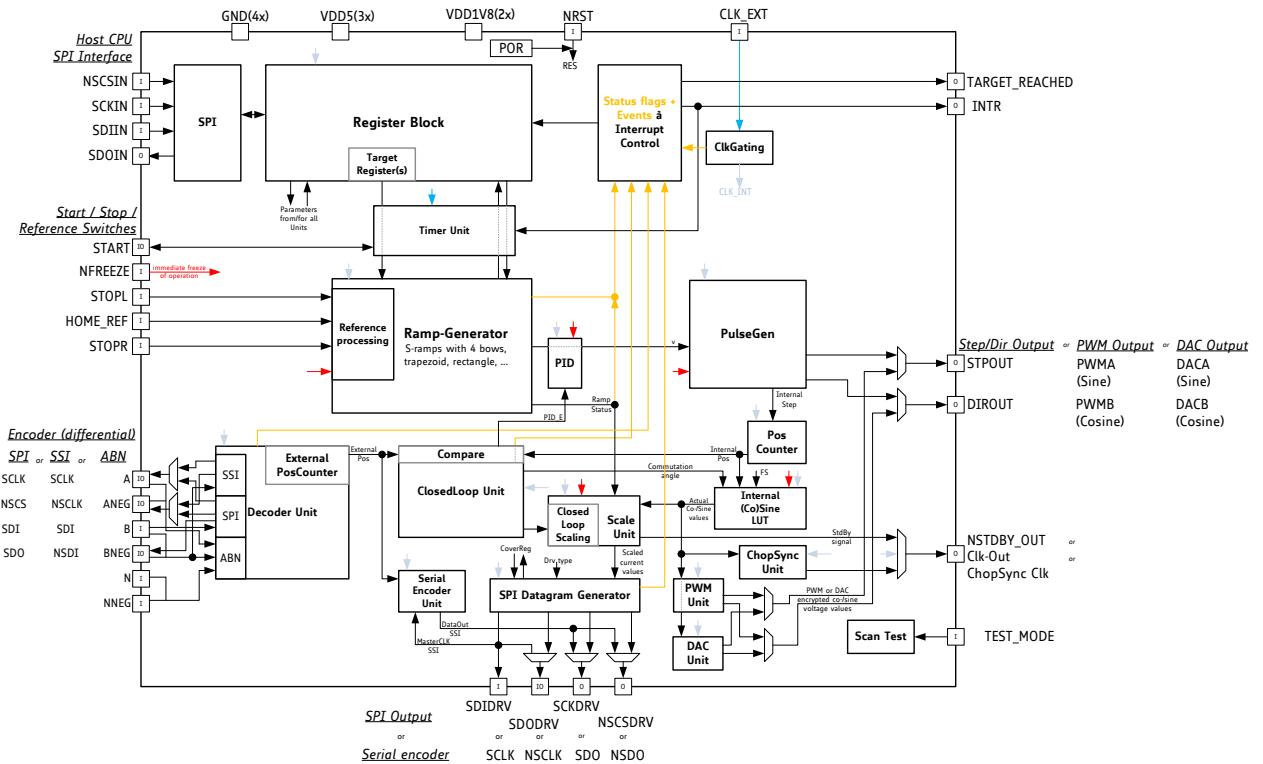
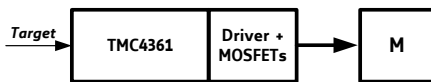

Figure 1.1 Basic application block diagram

1.1 Drive Concepts and Control Modes

The TMC4361 motion controller provides four different drive concepts respectively control modes. Choose the specific control mode related to the requirements of your application.

CLASSIC STEPPER WITH OPEN LOOP



OPEN LOOP WITH ENCODER CHECK

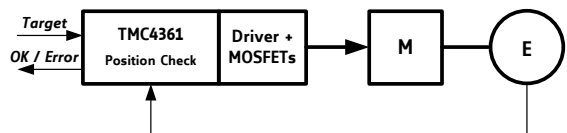

ENCODER FOR PRECISION AND POSITION MAINTENANCE

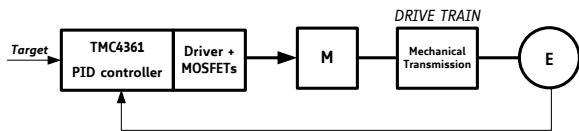

SERVO DRIVE: FEEDBACK CONTROL

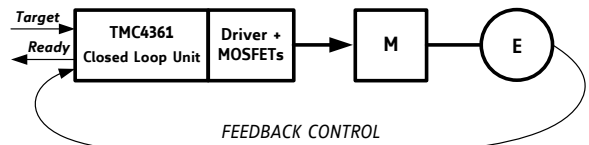

Figure 1.2 Drive Concepts. M=Motor, E=Encoder

1.2 Key Concepts

The TMC4361 realizes real time critical tasks autonomously and guarantees for a robust and reliable drive. The following features contribute toward greater precision, greater efficiency, higher reliability, higher velocity, and smoother motion in many stepper motor applications.

Interfacing	The TMC4361 offers application specific interfacing via SPI, Step/Dir, and PWM interface.
Initialization	Adapt the TMC4361 to the driver type and configuration and send initial configuration data to SPI drivers. Configure microstep resolution and waveform.
Positioning	The TMC4361 operates motor based on user specified target positions and velocities. Modify all motion target parameters on-the-fly during motion.
Microstepping	Based on internal position counters the TMC4361 performs up to $\pm 2^{31}$ (micro)steps completely independent from the microcontroller. Microstep resolutions are individually programmable. The range goes from full stepping (1 microstep = 1 full step) and half stepping (2 microsteps per full step) up to 8 bit micro stepping (256 microsteps per full step) for precise positioning and noiseless stepper motor rotation. With Step/Dir drivers any microstep resolution is possible as supported by the driver. The internal microstep table can be adapted to specific motor characteristics to further reduce torque ripple.
Servo Drive	The TMC4361 provides closed loop operation for Step/Dir and SPI drivers. Using a differential or serial encoder, the closed loop unit of the TMC4361 compares the external position counter values with the internal ones and sends signals for correction.
chopSync™	The TMC4361 has an integrated chopSync chopper for very smooth motor movement with TMC23x/24x.
Programming	Every parameter can be changed at any time. The uniform access to any TMC4361 register simplifies application programming. A read-back option for nearly all internal registers is available.
Synchronization	The TMC4361 provides synchronizing several TMC4361 motion controller chips if it is desired to drive motors simultaneously. In this case one TMC4361 is the master and the connected TMC4361 are slaves.

1.3 Overview Interfaces

1.3.1 SPI to CPU

From the software point of view, the TMC4361 provides a set of registers, accessed by a microcontroller via a serial interface in a uniform way. Each datagram contains address bits, a read-write selection bit, and data bits to access the registers and the on-chip memory. Each time the microcontroller sends a datagram to the TMC4361 it simultaneously receives a datagram from the TMC4361. This simplifies the communication with the TMC4361 and makes programming easy. Most microcontrollers have an SPI hardware interface, which directly connects to the serial four wire microcontroller interface of the TMC4361. For microcontrollers without SPI hardware, software doing the serial communication is sufficient and can easily be implemented. (For further information refer to chapter 5.)

1.3.2 SPI to Driver

The TMC4361 automatically generates the required data-stream for SPI drivers and provides user configurable microstep waves and motor ramps. The serial interface to the motor driver is configurable for all TRINAMIC drivers as well as for SPI DACs. Pre-settings for TRINAMIC driver chips are provided. (For further information refer to chapter 11.)

Third party driver chips can be configured via SPI interface using cover datagrams. During motor movement the SPI interface remains switched off and the Step/Dir interface is used for driving the motor.

1.3.3 Step/Dir to Driver

The TMC4361 provides a configurable Step/Dir interface to the driver. The motion controller controls the motor position by sending pulses on the STEP signal while indicating the direction on the DIR signal. Programmable step pulse length and step frequencies allow operation at high speed and high microstep resolution. The driver chip converts these signals into the coil currents which control the position of the motor. The TMC4361 perfectly fits to the TMC26x smart power Step/Dir driver family. (For further information refer to chapters 11.4 and 11.5.)

1.3.4 PWM Interface to Driver

The TMC4361 allows for using PWM output values instead of Step/Dir outputs due to disabling the Step/Dir output and forwarding PWM signals via STPOUT_PWMA and DIROUT_PWMB. The PWM frequency is calculated with $f_{PWM} = f_{CLK} / PWM_FREQ$. This mode supports noise-free and smooth microstepping with TMC23x and TMC24x stepper motor drivers. (For further information refer to chapter 13.)

1.3.5 Encoder Interface

The TMC4361 is equipped with a six pin encoder input interface for incremental ABN encoders (differential or single ended) or absolute encoders like SSI or SPI encoders. Motor feedback can be analyzed and closed loop behavior can be reached. All encoder input signals are filtered using an adaptable digital filter. (For further information refer to chapter 14.)

1.3.6 Reference Switches and Special IOs

The TMC4361 offers a left and a right stop switch in hardware as well as a home switch. Further, it provides two virtual stop switches which can trigger stop slopes in case the related virtual stop switch microstep position is reached. (Refer to chapter 9)

The START pin can be used as input or as output: a ramp start can be initialized via a start input signal. The other way round, the START pin can be used as output. In this case, multiple drivers can be synchronized using an internal start signal of a TMC4361 master and forwarding it as start trigger to further TMC4361 which act as slaves then. (Refer to chapter 10.1.)

The TMC4361 provides a clock output (STDBY_CLK). This output can be used to provide a step-synchronous chopper or application specific. (Refer to chapter 11.)

1.3.7 Safety Stop

The low-active safety pin NFREEZE can be used to end current operations without any delay. This way, an emergency-stop can be realized in case of dysfunctions on board level. (Refer to chapter 12.)

1.4 Step Frequencies

All parameter units are real physical units. Therefore, it is necessary to set the *CLK_FREQ* register to the appropriate value in [Hz] which is given by the external clock. As operation frequency any value between 4.2 MHz and 32 MHz can be chosen. The maximum motion velocity is restricted by the clock frequency. Values higher than $\frac{1}{2}$ pulse * f_{CLK} are prohibited because the STPOUT output remains active for one clock cycle and inactive for one clock cycle afterwards for a Step/Dir driver. The microstep resolution can be chosen in the range from full steps up to 256 microsteps per full step when using the internal sequencer. (Refer to chapter 8.2.3.)

1.5 Moving the Motor

Moving the motor is simple:

To move a motor to a *new target position*, write the target position into the associated register by sending a datagram to the TMC4361.

To move a motor with a *new target velocity*, write the velocity into the register assigned to the stepper motor.

1.5.1 Motion Controller Functionality

The ramp generator monitors the motion parameters stored in its registers and calculates velocity profiles. Based on the actual ramp generator velocity a pulse generator supplies step pulses to the motor driver and to the internal sequencer.

1.5.2 Ramp Modes and Types

Two general ramp modes can be chosen (see chapter 8.2):

Velocity mode The target velocity V_{MAX} will be reached using the selected ramp type.

Positioning mode The maximum velocity value is used within the given ramp type as long as the target position is not exceeded. The stepping direction depends on X_{ACTUAL} , X_{TARGET} , and the current ramp status.

Three ramp types can be selected: rectangle shaped ramps, trapezoidal ramps, and S-shaped ramps. S-shaped ramps in positioning mode finish exactly at the target position by keeping the actual velocity at maximum value as long as possible while staying within the motion limits. The slopes to and from maximum velocity are as fast as possible without exceeding limits.

1.6 Status Flags, Events, and Interrupts

The microcontroller connected to the TMC4361 normally requires status information. Therefore, the TMC4361 provides 32 status flags and 32 status events. Status events can be configured customer specific and led through to the interrupt output of the TMC4361. (Refer to chapter 7.)

2 Pin Assignments

2.1 Package Outline

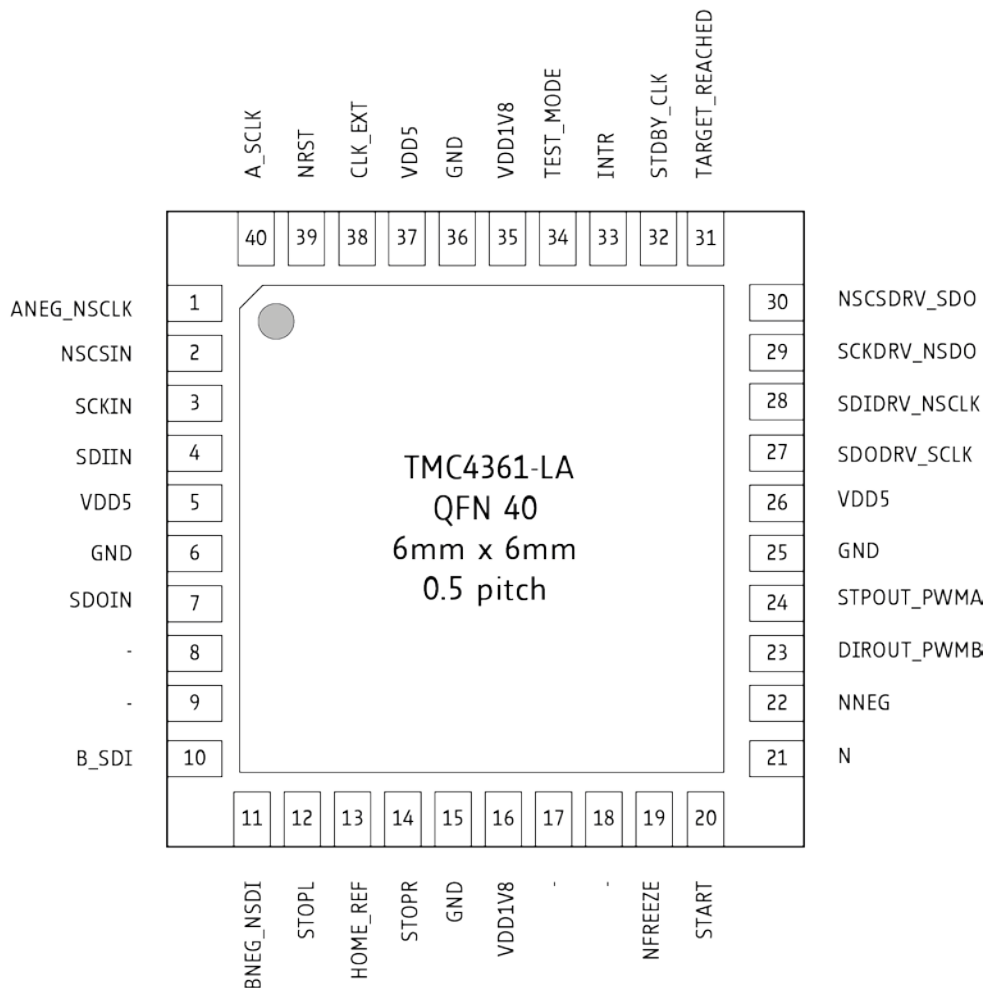

Figure 2.1 Pinning (top view)

Attention: Do not connect pins without assignment!

2.2 Signal Description

Pin	Number	Type	Function
GND	6,15, 25,36	GND	Digital ground pin for IOs and digital circuitry
VDD5	5,26,37	VDD	Digital power supply for IOs and digital circuitry (3.3V... 5V)
VDD1V8	16,35	VDD	Connection of <i>internal generated</i> core voltage of 1.8V
NSCSIN	2	I	Low active chip select input of the SPI interface to the μC
SCKIN	3	I	Serial clock for the SPI interface to the μC
SDIIN	4	I	Serial data input of the SPI interface to the μC
SDOIN	7	O	Serial data output of the SPI interface to the μC (Z if NSCSIN=1)
CLK_EXT	38	I	Clock input to provide a clock with the frequency f_{CLK} for all internal operations.
NRST	39	I (PU)	Low active reset. If not connected, Power-on-Reset and internal pull-up resistor will be active.
TEST_MODE	34	I	Test mode input. Tie to low for normal operation.

Pin	Number	Type	Function
STOPL	12	I (PD)	Left stop switch. External signal to stop a ramp. If not connected, an internal pull-down resistor will be active.
HOME_REF	13	I (PD)	Home reference signal input. External signal for reference search.If not connected,an internal pull-down resistor will be active.
STOPR	14	I (PD)	Right stop switch. External signal to stop a ramp. If not connected, an internal pull-down resistor will be active.
INTR	33	O	Interrupt output
TARGET_REACHED	31	O	Target reached output
START	20	IO	Start signal input/output
NFREEZE	19	I (PU)	Low active safety pin to immediately freeze output operations.If not connected, an internal pull-up resistor will be active.
STDBY_CLK	32	O	StandBy signal or internal CLK output or ChopSync output
N	21	I (PD)	N signal input of incremental encoder input interface If not connected, an internal pull-down resistor will be active.
NNEG	22	I (PD)	Negated N signal input of incremental encoder input interface If not connected, an internal pull-down resistor will be active.
B SDI	10	I (PD)	B signal input of incremental encoder input interface. Serial data input signal of serial encoder input interface (SSI/SPI). If not connected, an internal pull-down resistor will be active.
BNEG NSDI SDO_ENC	11	IO	Negated B signal input of incremental encoder input interface. Negated serial data input signal of SSI encoder input interface Serial data output of SPI encoder input interface.
A SCLK	40	IO	A signal input of incremental encoder interface. Serial clock output signal of serial encoder interface (SSI/SPI).
ANEG NSCLK NSCS_ENC	1	IO	Negated A signal input of incremental encoder interface. Negated serial clock output signal of serial encoder interface. Low active chip select output of SPI encoder input interface.
STPOUT PWMA DACA	24	O	Step output. First PWM signal (Sine). First DAC output signal (Sine).
DIROUT PWMB DACB	23	O	Direction output. Second PWM signal (Cosine). Second DAC output signal (Cosine).
NSCSDRV SDO	30	O	Low active chip select output of SPI interface to motor driver. Serial data output of serial encoder output interface.
SCKDRV NSDO	29	O	Serial clock output of SPI interface to motor driver. Negated serial data output of serial encoder output interface.
SDODRV SCLK	27	IO	Serial data output of SPI interface to motor driver. Clock input of serial encoder output interface.
SDIDRV NSCLK	28	I (PD)	Serial data input of SPI interface to motor driver. Negated clock input of serial encoder output interface If not connected, an internal pull-down resistor will be active.
n.c.	8,9,17,18	-	Do not connect

PD: if n.c. → pull-down

PU: if n.c. → pull-up

3 Sample Circuits

The sample circuits show the connection of external components.

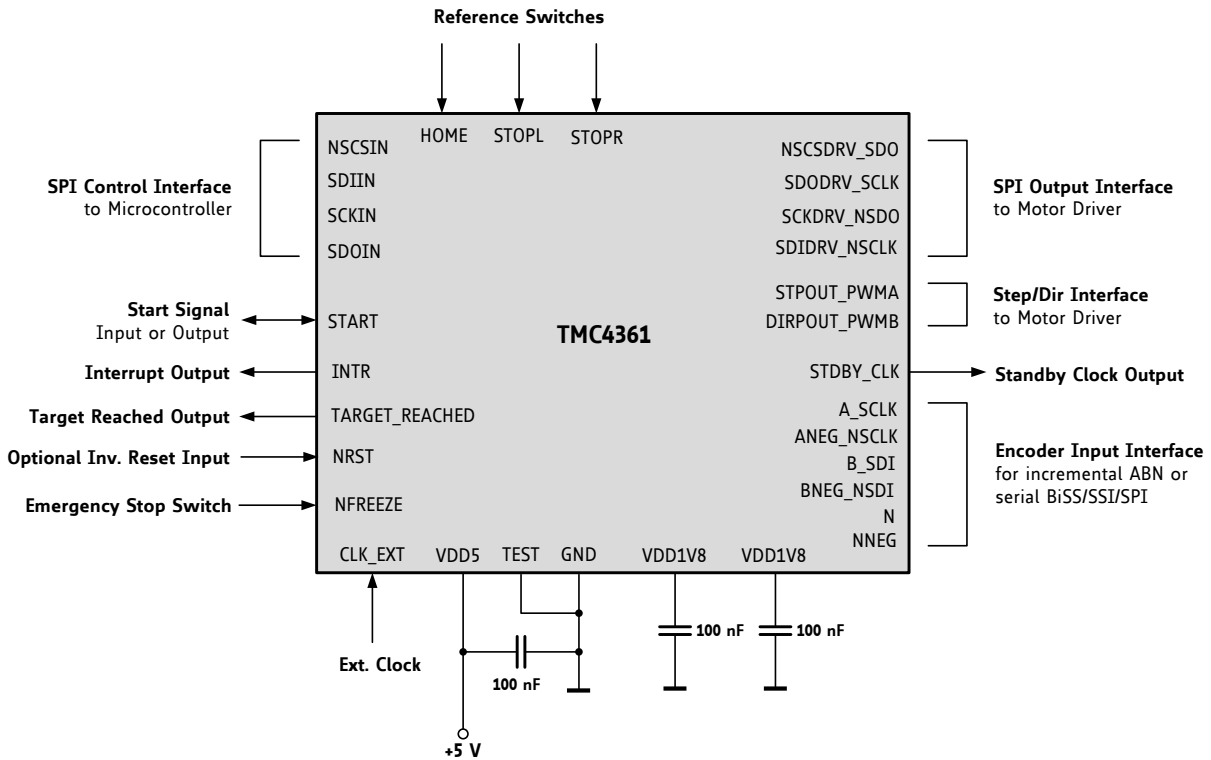

Figure 3.1 How to connect the TMC4361

CHECK YOUR CONNECTIONS!

1. Check, if the STDBY_CLK output provides the pulse which is applied at the CLK_EXT input pin. If both values fit, POR (power on reset), power supply and clk frequency are ready to be used.
2. The SPI communication to TMC4361 is established if the step frequency at STPOUT_PWMA matches to the selected value of VMAX (maximum velocity value). This relationship is valid with a clock frequency of 16MHz. When using another frequency, it is necessary to convert the values appropriately.

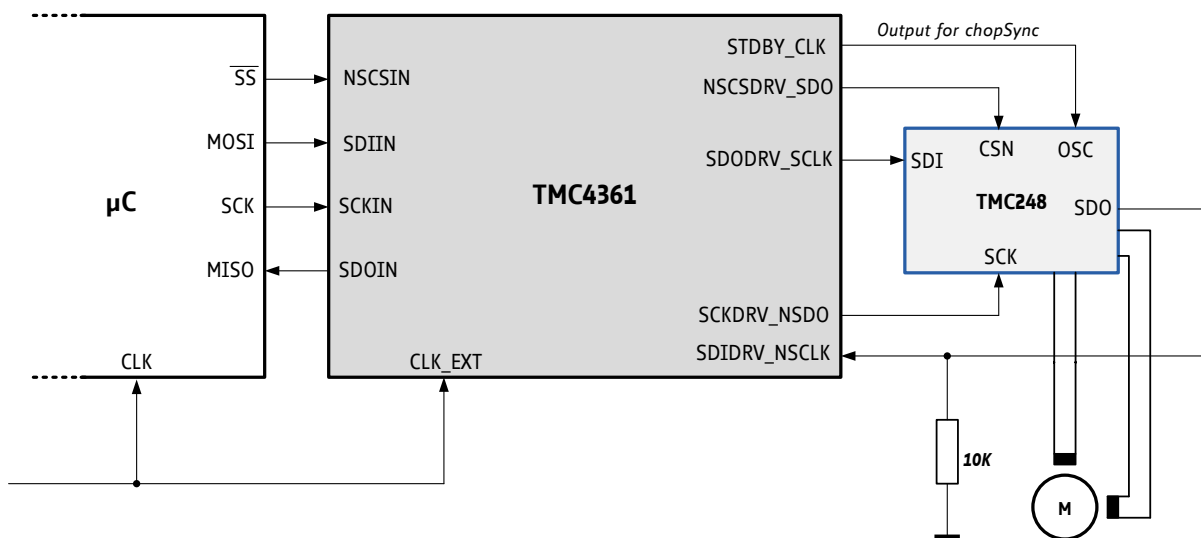

Figure 3.2 TMC4361 with TMC248 stepper driver in SPI mode

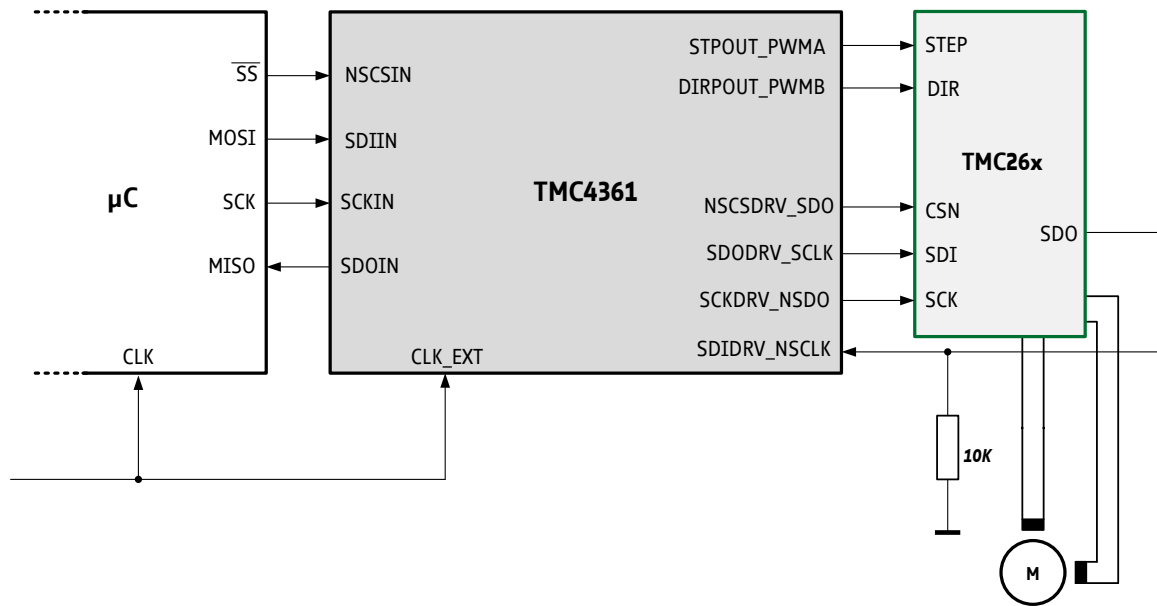

Figure 3.3 TMC4361 with TMC26x stepper driver in Step/Dir mode. The SPI interface is used for configuration.

4 Notes

REGISTER names are italicized with VALUE REGISTER in capital letters and switches with small letters.

PIN names are written with capital letters.

5 SPI Control Interface

The TMC4361 uses 40 bit SPI™ datagrams for communication with a microcontroller. The bit-serial interface is synchronous to a bus clock. For every bit sent from the bus master to the bus slave, another bit is sent simultaneously from the slave to the master. Communication between an SPI master and the TMC4361 slave always consists of sending one 40-bit command word and receiving one 40-bit status word. The SPI command rate typically comprises a few commands per complete motor motion.

SPI CONTROL INTERFACE

Pin Name	Type	Remarks
NSCSIN	Input	Chip Select of the SPI- μ C interface (low active)
SCKIN	Input	Clock of the SPI- μ C interface
SDIIN	Input	Data input of the SPI- μ C interface
SDOIN	Output	Data output of the SPI- μ C interface

5.1 SPI Datagram Structure

Microcontrollers which are equipped with hardware SPI are typically able to communicate using integer multiples of 8 bit. The NSCSIN line of the TMC4361 has to be handled in a way, that it stays active (low) for the complete duration of the datagram transmission.

Each datagram sent to the TMC4361 is composed of an address byte followed by four data bytes. This allows direct 32 bit data word communication with the register set of the TMC4361. Each register is accessed via 32 data bits even if it uses less than 32 data bits.

Each register is specified by a one byte address:

- For a read access the most significant bit of the address byte is 0.
- For a write access the most significant bit of the address byte is 1.

Some registers are write only registers, most can be read additionally, and there are also some read only registers.

TMC4361 SPI DATAGRAM STRUCTURE																																																	
MSB (transmitted first)										40 bit										LSB (transmitted last)																													
39 0																																							
→ 8 bit address					↔ 32 bit data															← 8 bit SPI status																													
39 ... 32										31 ... 0																																							
→ to TMC4361: RW + 7 bit address										8 bit data					8 bit data					8 bit data					8 bit data																								
← from TMC4361: 8 bit SPI status																																																	
39 / 38 ... 32										31 ... 24					23 ... 16					15 ... 8					7 ... 0																								
w 38...32										31...28		27...24			23...20		19...16			15...12		11...8			7...4		3...0																						
3	3	3	3	3	3	3	3	3	3	3	3	2	2	2	2	2	2	2	2	1	1	1	1	1	1	1	1	1	1	1	1	1	1	9	8	7	6	5	4	3	2	1	0						
9	8	7	6	5	4	3	2	1	0	9	8	7	6	5	4	3	2	1	0	9	8	7	6	5	4	3	2	1	0	9	8	7	6	5	4	3	2	1	0	9	8	7	6	5	4	3	2	1	0

5.1.1 Selection of Write / Read (WRITE_notREAD)

The read and write selection is controlled by the MSB of the address byte (bit 39 of the SPI datagram). This bit is 0 for read access and 1 for write access. So, the bit named W is a WRITE_notREAD control bit. The active high write bit is the MSB of the address byte. Thus, 0x80 has to be added to the address for a write access. The SPI interface always delivers data back to the master, independent of the W bit. The data transferred back is the data read from the address which was transmitted with the *previous* datagram, if the previous access was a read access. If the previous access was a write access, then the data read back mirrors the previously received write data. So, the difference between a read and a write access is that the read access does not transfer data to the addressed register but it transfers the address

only and its 32 data bits are dummies. Further, the following read or write access delivers back data read from the address transmitted in the preceding read cycle.

A read access request datagram uses dummy write data. Read data is transferred back to the master with the subsequent read or write access. Hence, reading multiple registers can be done in a pipelined fashion. Data which will be delivered are latched immediately after the prior data transfer.

Whenever data is read from or written to the TMC4361, the MSBs delivered back contain the SPI status *SPI_STATUS*, which is a number of eight status bits. The selection of these bits will be explained in chapter 7.2.

Example:

For a read access to the register (*XACTUAL*) with the address 0x21, the address byte has to be set to 0x21 in the access preceding the read access. For a write access to the register (*VACTUAL*), the address byte has to be set to $0x80 + 0x22 = 0xA2$. For read access, the data bit might have any value, e.g., 0.

action	data sent to TMC...	data received from TMC...
read <i>XACTUAL</i>	→0x2100000000	←0xSS & unused data
read <i>XACTUAL</i>	→0x2100000000	←0xSS & X_ACTUAL
write <i>VACTUAL</i> := 0x00ABCDEF	→0xA200ABCDEF	←0xSS & X_ACTUAL
write <i>VACTUAL</i> := 0x00123456	→0xA200123456	←0xSS00ABCDEF

*) SS: is a placeholder for the status bits *SPI_STATUS*

5.1.2 Data Alignment

All data are right aligned. Some registers represent unsigned (positive) values; some represent integer values (signed) as two's complement numbers. Single bits or groups of bits are represented as single bits respectively as integer groups.

5.2 SPI Signals

The SPI bus on the TMC4361 has four signals:

- SCKIN – bus clock input
- SDIIN – serial data input
- SDOIN – serial data output
- NSCSIN – chip select input (active low)

The slave is enabled for an SPI transaction by a transition to low level on the chip select input NSCSIN. Bit transfer is synchronous to the bus clock SCKIN, with the slave latching the data from SDIIN on the rising edge of SCKIN and driving data to SDOIN following the falling edge. The most significant bit is sent first. A minimum of 40 SCKIN clock cycles is required for a bus transaction with the TMC4361. If less than 40 clock cycles are transmitted, the transfer will not be valid, even for a read access. However, sending only eight clock cycles can be useful to obtain the SPI status because it sends the status information back first.

If more than 40 clocks are driven, the additional bits shifted into SDIIN are shifted out on SDOIN after a 40-clock delay through an internal shift register. This can be used for daisy chaining multiple chips.

NSCSIN must be low during the whole bus transaction. When NSCSIN goes high, the contents of the internal shift register are latched into the internal control register and recognized as a command from the master to the slave. If more than 40 bits are sent, only the last 40 bits received before the rising edge of NSCSIN are recognized as the command.

5.3 Timing

The SPI interface is synchronized to the internal system clock, which limits the SPI bus clock SCKIN to half of the system clock frequency. The signal processing of the SPI inputs are supported with internal Schmitt Trigger, but not with RC elements. To avoid glitches at the inputs of the SPI interface between μC and TMC4361, external RC elements have to be provided. Figure 5.1 shows the timing parameters of an SPI bus transaction and the table below specifies the parameter values.

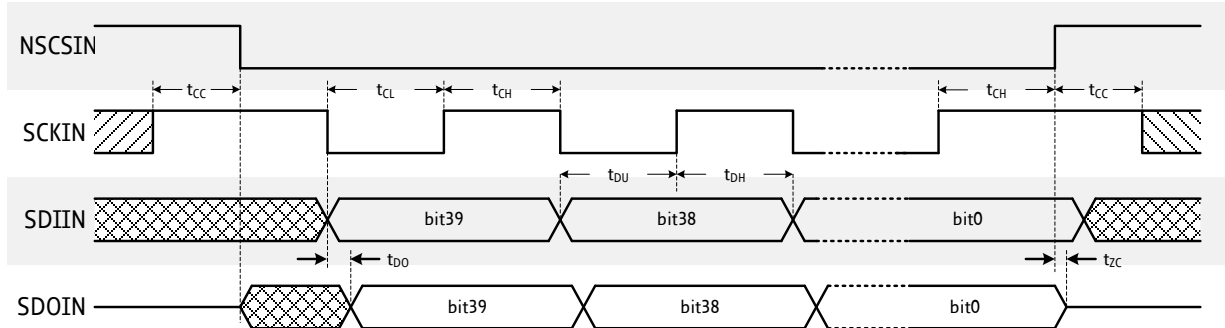

Figure 5.1 SPI timing

SPI interface timing	AC-Characteristics					
	clock period: t_{CLK}					
Parameter	Symbol	Conditions	Min	Typ	Max	Unit
SCKIN valid before or after change of NSCSIN	t_{CC}		10			ns
NSCSIN high time	t_{CSH}	*) Min time is for synchronous CLK with SCKIN high one t_{CH} before SCSIN high only	$t_{\text{CLK}}^{*)}$	$>2t_{\text{CLK}}+10$		ns
SCKIN low time	t_{CL}	*) Min time is for synchronous CLK only	$t_{\text{CLK}}^{*)}$	$>t_{\text{CLK}}+10$		ns
SCKIN high time	t_{CH}	*) Min time is for synchronous CLK only	$t_{\text{CLK}}^{*)}$	$>t_{\text{CLK}}+10$		ns
SCKIN frequency using external clock (Example: $f_{\text{CLK}} = 16 \text{ MHz}$)	f_{SCK}	assumes synchronous CLK			$f_{\text{CLK}} / 2$ (8)	MHz
SDIIN setup time before rising edge of SCKIN	t_{DU}		10			ns
SDIIN hold time after rising edge of SCKIN	t_{DH}		10			ns
Data out valid time after falling SCKIN clock edge	t_{DO}	no capacitive load on SDOIN			$t_{\text{FILT}}+5$	ns

$$t_{\text{CLK}} = 1 / f_{\text{CLK}}$$

6 Input Filtering

Input signals can be noisy due to long cables and circuit paths. To prevent jamming, every input pin provides a Schmitt Trigger. Additionally, several signals are passed through a digital filter. Particular input pins are separated into four filtering groups. Each group can be programmed individually according to its filter characteristics.

PINS AND REGISTERS: INPUT FILTERING GROUPS

Pin names	Type	Remarks
A_SCLK B_SDI N ANEG_NSCLK BNEG_NSDI NNEG	Inputs	Encoder interface input pins
STOPL HOME_REF STOPR	Inputs	Reference input pins
START	Input	START input pin
SDODRV_SCLK SDIDRV_NSCLK	Inputs	Master clock input interface pins for serial encoder
Pin name	Register address	Remarks
INPUT_FILT_CONF	0x03 RW	Filter configuration for all four input groups

6.1 Input Filter Configuration

Every filtering group can be configured separately with regard to input sample rate and digital filter length.

6.1.1 Input Sample Rate (SR)

$$f_{\text{CLK}} \cdot 1 / 2^{\text{SR}}$$

where SR (extended with the particular name extension) is in [0... 7].

This means that every (2^{SR})th input bit will be considered for internal processing.

Sample rate configuration	
SR value	Sample rate
0	f_{CLK}
1	$f_{\text{CLK}} / 2$
2	$f_{\text{CLK}} / 4$
3	$f_{\text{CLK}} / 8$
4	$f_{\text{CLK}} / 16$
5	$f_{\text{CLK}} / 32$
6	$f_{\text{CLK}} / 64$
7	$f_{\text{CLK}} / 128$

6.1.2 Digital Filter Length (FILT_L)

One bit is sampled within each (2^{SR})th input clock cycle. The filter length FILT_L can be set within the range [0... 7]. The filter length FILT_L specifies the number of sampled bits that must have the same voltage level to set a new input bit voltage level.

Configuration of digital filter length	
FILT_L value	Filter length
0	No filtering
1	2 equal bits
2	3 equal bits
3	4 equal bits
4	5 equal bits
5	6 equal bits
6	7 equal bits
7	8 equal bits

6.1.3 Examples

The following three examples depict the input pin filtering of three different input filtering groups. The voltage levels after passing the Schmitt Trigger are compared to the internal signals which are processed by the motion controller.

The sample points are depicted as green dashed lines.

REFERENCE INPUT PINS

Here, every second clock cycle is sampled. Two sampled input bits must be equal to be a valid input voltage.

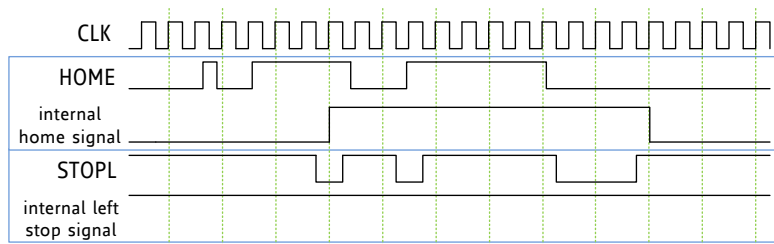

Figure 6.1 Reference input pins: SR_REF = 1, FILT_L_REF = 1

START INPUT PIN

Every fourth clock cycle is sampled and the sampled input bit is valid.

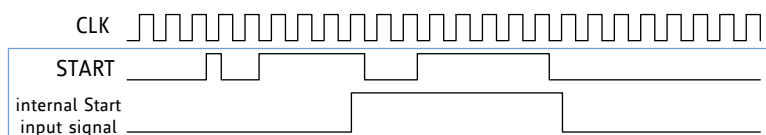

Figure 6.2 START input pin: SR_S = 2, FILT_L_S = 0

ENCODER INTERFACE INPUT PINS

Every clock cycle bit is sampled. Eight sampled input bits must be equal to be a valid input voltage.

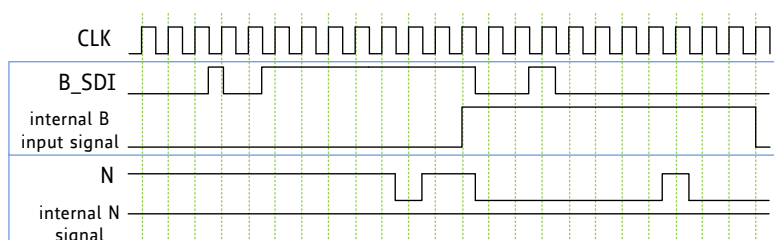

Figure 6.3 Encoder interface input pins: SR_ENC_IN = 0, FILT_L_ENC_IN = 7

7 Status Flags & Events

The TMC4361 offers several possibilities for velocity ramps. It combines target positioning and velocity ramps without interventions in between. However, the microcontroller connected to the TMC4361 normally requires status information. Therefore, TMC4361 provides 32 status flags and 32 status events. Status events can be configured customer specific and lead through using the interrupt output of the TMC4361. Further, the eight SPI status bits sent with each SPI datagram can be read out.

PINS AND REGISTERS: STATUS FLAGS AND EVENTS

Pin names	Type		Remarks
INTR	Output		Interrupt output to indicate status events
Register name	Register address		Remarks
STATUS_FLAGS	0x0F	R	32 status flags of the TMC4361 and the connected TMC motor driver chip
EVENTS	0x0E	R+C	32 events triggered by altered TMC4361 status bits
SPI_STATUS_SELECTION	0x0B	RW	Selection of 8 out of 32 events for SPI status bits
EVENT_CLEAR_CONF	0x0C	RW	Exceptions for cleared event bits
INTR_CONF	0x0D	RW	Selection of 32 events for INTR output

7.1 Status Flags

Status bits of the *STATUS_FLAGS* register are specified in the register chapter (see 17).

7.2 Status Events & SPI Status & Interrupts

STATUS FLAGS - STATUS EVENTS

Status events are triggered during the transition process of status bits from inactive to active level. Status bits and status events are associated in different ways:

- Several status events are associated with one status bit.
- Some status events show the status transition of one or more status bits out of a status bit group. The motor driver flags, e.g., trigger only one motor driver event *MOTOR_EV* in case one of the selected motor driver status flags becomes active.
- In case a flag consists of more than one bit, the number of associated events that can be triggered corresponds to the valid combinations. The *VEL_STATE* flag, e.g., has two bit but three associated velocity state events (00/01/10). Such an event is triggered if the associated combination switches from inactive to active.
- Furthermore, some events have no equivalence in the *STATUS_FLAGS* register (e.g., *COVER_DONE* which indicates new data from the motor driver chip).

The *EVENTS* register is automatically cleared after reading the register subsequent to an SPI datagram request.

To prevent events from being cleared, the *EVENT_CLEAR_CONF* register can be assigned properly. Just set the related *EVENT_CLEAR_CONF* register bit position to 1.

HOW TO AVOID A LACK OF INFORMATION

The recognition of a status event can fail in case it is triggered right before or during the *EVENTS* register becomes cleared. By setting the *EVENT_CLEAR_CONF* register appropriately, this can be avoided. Up to eight events can be selected for permanent SPI status report. Therefore, select up to eight events by writing 1 to the specific bit positions of the *SPI_STATUS_SELECTION* register. The bit positions are sorted according to the event bit positions in the *EVENTS* register. In case more than eight events are chosen, the first eight bits (starting from index 0) are forwarded as *SPI_STATUS*.

INTERRUPTS

Similar to the *EVENT_CLEAR_CONF* register and the *SPI_STATUS_SELECTION* register, events can be selected using the *INTR_CONF* register to be forwarded to the INTR output. The active polarity of the INTR output can be set with *intr_pol*. The selected events will be ORed to one signal. The INTR output becomes active as soon as one of the selected events triggers.

Due to the importance of events for interrupt generation and SPI status monitoring, it is recommended to clear the *EVENTS* register before starting regular operation.

8 Ramp Generator

Step generation is one of the main tasks of a stepper motor motion controller. The internal ramp generator of the TMC4361 provides several ways of step generation in order to form different ramp types to fit for various applications.

PINS AND REGISTERS: RAMP GENERATOR

Pin names	Type		Remarks
STPOUT_PWMA	Output		Step output signal
DIROUT_PWMB	Output		Direction output signal
Register name	Register address		Remarks
GENERAL_CONF	0x00	RW	Ramp generator affecting bits 1 : 5
STP_LENGTH_ADD	0x10	RW	Additional step length in clock cycles; 16 bits
DIR_SETUP_TIME			Additional time in clock cycles when no steps will occur after a direction change; 16 bits
RAMPMODE	0x20	RW	Requested ramp type and mode; 3 bits
XACTUAL	0x21	RW	Current internal microstep position; signed; 32 bits
VACTUAL	0x22	R	Current step velocity; 24 bits; signed; no decimals
AACTUAL	0x23	R	Current step acceleration; 24 bits; signed; no decimals
VMAX	0x24	RW	Maximum permitted or target velocity; signed; 32 bits=24+8 (24 bits integer part, 8 bits decimal places)
VSTART	0x25	RW	Velocity at ramp start; unsigned; 31 bits=23+8
VSTOP	0x26	RW	Velocity at ramp end; unsigned; 31 bits=23+8
VBREAK	0x27	RW	At this velocity value, the ac-/deceleration will change during trapezoidal ramps; unsigned; 31 bits=23+8
AMAX	0x28	RW	Maximum permitted or target acceleration; unsigned; 24 bits=22+2 (22 bits integer part, 2 bits decimal places)
DMAX	0x29	RW	Maximum permitted or target deceleration; unsigned; 24 bits=22+2
ASTART	0x2A	RW	Acceleration at ramp start or below VBREAK; unsigned; 24 bits=22+2
DFINAL	0x2B	RW	Deceleration at ramp end or below VBREAK; unsigned; 24 bits=22+2
BOW1	0x2D	RW	First bow value of a complete velocity ramp; unsigned; 24 bits=24+0 (24 bits integer part, no decimal places)
BOW2	0x2E	RW	Second bow value of a complete velocity ramp; unsigned; 24 bits=24+0
BOW3	0x2F	RW	Third bow value of a complete velocity ramp; unsigned; 24 bits=24+0
BOW4	0x30	RW	Fourth bow value of a complete velocity ramp; unsigned; 24 bits=24+0
CLK_FREQ	0x31	RW	External clock frequency f_{CLK} ; unsigned; 25 bits
XTARGET	0x37	RW	Target position; signed; 32 bits

8.1 Step/Dir Output Configuration

Step/Dir output signals can be configured for the driver circuit:

- For step signals that have to be longer than one clock cycle set `STP_LENGTH_ADD` appropriately. Then, the resulting step length is equal to `STP_LENGTH_ADD+1` clock cycles. Thus, the step length can be chosen within the range $1 \dots 2^{16}$ clock cycles.
- `DIROUT` does not change the level during the active step pulse signal and for `STP_LENGTH_ADD+1` clock cycles after the step signal returns to the inactive level.
- With the register `DIR_SETUP_TIME` the delay [clock cycles] between `DIROUT` and `STPOUT` voltage level changes can be set. Using this register, no steps are sent via `STPOUT` for `DIR_SETUP_TIME` clock cycles after a level change at `DIROUT`.

Note:

- Per default, the step output is high active because a rising edge at STPOUT indicates a step.
- For changing the polarity, set *step_inactive_pol*=1. Now, each falling edge indicates a step.
- A step can be generated by toggling the step output. Therefore, set *toggle_step*=1.
- *pol_dir_out* sets the output level for the negative velocity direction.
- *pol_dir_out*, *step_inactive_pol*, and *toggle_step* are part of the general configuration register.

8.2 Ramp Modes and Types

With proper configuration, the internal ramp generator of the TMC4361 is able to generate various ramps and the related step outputs for STPOUT. Note, that there are many possibilities to combine a *general ramp mode* (velocity mode, positioning mode) with *basic ramp types* (ramp in hold mode, trapezoidal ramp, S-shaped ramp). Therefore, select the general ramp mode first and proceed with the ramp type and further specifications, e.g., setting start and stop velocities or choosing different acceleration/deceleration values for each ramp phase.

GENERAL RAMP MODES

Two general ramp modes can be chosen with the *RAMPMODE* register. Therefore, bit 2 of the *Ramp Generator Register Set* (see chapter 17.16) is used:

RAMPMODE(2)=0 *Velocity mode*. The target velocity *VMAX* will be reached using the selected ramp type.

RAMPMODE(2)=1 *Positioning mode*. *VMAX* is the maximum velocity value which will be used within the given ramp type and as long as the target position *XTARGET* will not be exceeded. Furthermore, the sign of *VMAX* is not relevant during positioning. The direction of the steps depends on *XACTUAL*, *XTARGET*, and the current ramp status.

RAMP TYPES

Three basic ramp types are provided. These types differ in the velocity value development during the drive. For setting the basic ramp type, use the *Ramp Generator Register Set* bits 1 and 0.

TMC4361 RAMP TYPES		
<i>RAMPMODE</i> (1 : 0)	Ramp type	Function
b'00	<i>Ramp in hold mode</i>	Follow <i>VMAX</i> only (rectangle velocity shape).
b'01	<i>Trapezoidal ramp</i>	Consideration of acceleration and deceleration values without adaption of these values.
b'10	<i>S-shaped ramp</i>	Use all ramp values (including bow values).

RAMPMODE(1 : 0)=00

Rectangle shaped ramp type in hold mode. *VACTUAL* is set immediately to *VMAX*.

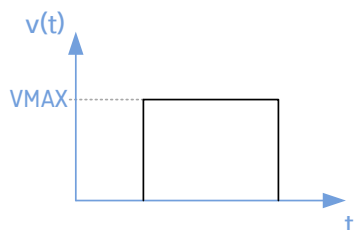

In positioning mode (*RAMPMODE*(2)=1), *VACTUAL* is set instantly to 0 if the target position is reached.

For exact positioning, it is recommended to set $V_{MAX} \leq f_{CLK} \cdot \frac{1}{4}$ pulses

Figure 8.1 Rectangle shaped ramp type

RAMPMODE(1 : 0)=01

Trapezoidal shaped ramp type

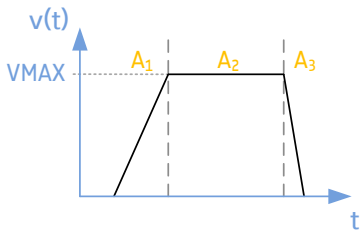

Acceleration slope and deceleration slope have only one acceleration/deceleration value each. For this types, set $VBREAK = 0$.

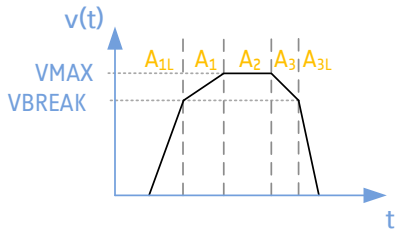

The acceleration/deceleration factor alters at $VBREAK$. In positioning mode, the ramp finishes exactly at the target position $XTARGET$ by keeping $VACTUAL = VMAX$ as long as possible.

Figure 8.2 Trapezoidal shaped ramp type

This trapezoidal ramp type reaches $VMAX$ using linear ramps whereas the actual acceleration/deceleration factor A_{ACTUAL} depends on the current ramp phase and the velocity which should be reached. The corresponding sign assignment for different ramp phases is depicted in the following table:

Ramp phase:	A_{1L}	A_1	A_2	A_3	A_{3L}
$v > 0$: $A_{ACTUAL} =$	A_{START}	A_{MAX}	0	$-D_{MAX}$	$-D_{FINAL}$
$v < 0$: $A_{ACTUAL} =$	$-A_{START}$	$-A_{MAX}$	0	D_{MAX}	D_{FINAL}

RAMPMODE(1 : 0)=10

S-shaped ramp types

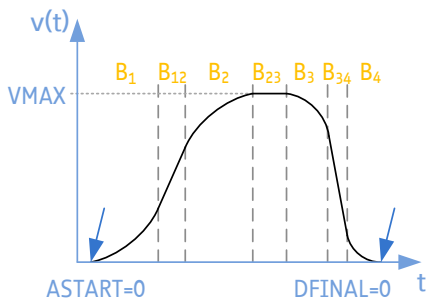
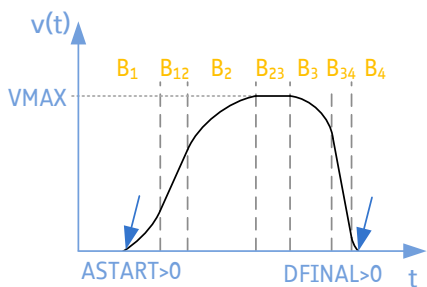

Figure 8.3 S-shaped ramp without initial and final acceleration/deceleration values



The start phase and the end phase of an S-shaped ramp can be accelerated/decelerated by A_{START} and D_{FINAL} . Using these parameters, the ramp starts with A_{START} and it is ended with D_{FINAL} . D_{FINAL} becomes valid as soon as A_{ACTUAL} reaches the chosen D_{FINAL} value. A_{START} and D_{FINAL} can be set separately.

Figure 8.4 S-shaped ramp type with initial acceleration and final deceleration value for B1 and B4

This ramp type reaches $VMAX$ by means of S-shaped ramps whereas the acceleration/deceleration factor depends on the current ramp phase and alters every 64 clock cycles during the bow phases B_1 , B_2 , B_3 , and B_4 .

Ramp phase:	B ₁	B ₁₂	B ₂	B ₂₃	B ₃	B ₃₄	B ₄
v>0: AACTUAL=	ASTART→AMAX	AMAX	AMAX→0	0	0→-DMAX	-DMAX	-DMAX→-DFINAL
BOW _{ACTUAL} =	BOW1	0	-BOW2	0	-BOW3	0	BOW4
v<0: AACTUAL=	-ASTART→-AMAX	-AMAX	-AMAX→0	0	0→DMAX	DMAX	DMAX→DFINAL
BOW _{ACTUAL} =	-BOW1	0	BOW2	0	BOW3	0	-BOW4

S-SHAPED RAMPS IN POSITIONING MODE

The ramp finishes exactly at the target position by keeping $abs(VACTUAL) = VMAX$ as long as possible. Furthermore, the slopes to and from $VMAX$ are as fast as possible without exceeding given values. It is even possible that the phases B_{12} , B_{23} , and B_{34} are left out due to given values. Nevertheless, the S-shaped ramp style is always performed in positioning mode, if $RAMP_MODE(1 : 0) = b'10$ is set. The parameter $DFINAL$ is not considered during positioning mode.

8.2.1 Velocity Start $VSTART$ and Velocity Stop $VSTOP$

S-shaped and trapezoidal velocity ramps can be started with an initial velocity value by setting $VSTART$ higher than zero (see Figure 8.5). Such an S-shaped ramp with $VSTART > 0$ is a ramp without the first ramp bow B_1 . The ramp starts with $AACTUAL = AMAX$ and $VACTUAL = VSTART$. Logically, the parameter $ASTART$ is not considered.

It is also possible to set $VSTOP$ (a final velocity value) which finishes the ramp if $VACTUAL$ reaches the $VSTOP$ value (see Figure 8.6). This leads to an S-shaped velocity ramp without the bow B_4 . Hence, $DFINAL$ is not considered.

TRAPEZOIDAL AND S-SHAPED RAMPS USING PARAMETER $VSTART$

$VSTART > 0$ and $VSTOP = 0$

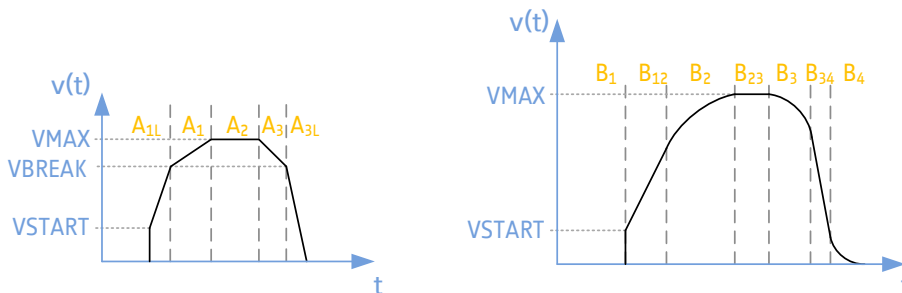

Figure 8.5 Trapezoidal and S-shaped ramps using $VSTART$

TRAPEZOIDAL AND S-SHAPED RAMPS USING PARAMETER $VSTOP$

$VSTART = 0$ and $VSTOP > 0$

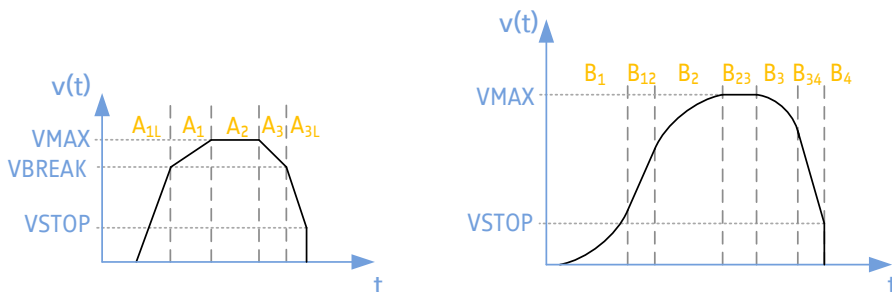

Figure 8.6 Trapezoidal and S-shaped ramps using $VSTOP$

TRAPEZOIDAL AND S-SHAPED RAMPS USING PARAMETERS $VSTART$ AND $VSTOP$

$VSTART > 0$ and $VSTOP > 0$

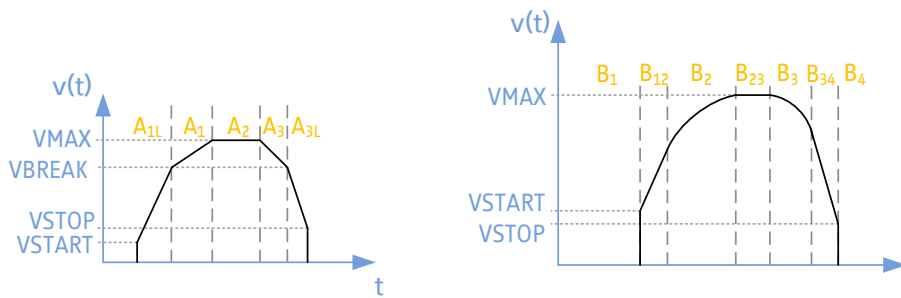

Figure 8.7 Trapezoidal and S-shaped ramps using $VSTART$ and $VSTOP$

SUGGESTIONS

- $VSTART$ and $VSTOP$ are used when starting or ending a velocity ramp. If the velocity direction alters due to register assignments while a velocity ramp is in progress, the velocity values develop according to the current velocity ramp type without using $VSTART$ or $VSTOP$.
- $VSTOP$ is used in positioning mode when the target position is reached. In velocity mode, $VSTOP$ is only used when $VACTUAL \neq 0$ and the target velocity $VMAX$ is assigned to 0.
- The unsigned values $VSTART$ and $VSTOP$ are valid for both velocity directions.
- Every register value change is assigned immediately.

8.2.2 Limitations

ATTENTION

- Ramp parameter value changes in positioning mode during the ramp progress (except $VMAX$ and $XTARGET$) are allowed but can result in a temporarily overshooting of $XTARGET$.
- To stop an S-shaped ramp during positioning do not set only $VMAX = 0$! There are two possibilities for further settings:
Switch to velocity mode soon after setting $VMAX = 0$ and when reaching $VACTUAL = 0$ ($VEL_REACHED$ event triggers) switch back to positioning mode.
The other possibility is to set $VMAX = 1$. As soon as the $VEL_REACHED$ event triggers, set $VMAX$ to 0.
- *Only valid for trapezoidal ramps:* If a register value during a deceleration ramp (e.g. target position) is altered in a way that an immediate acceleration in the same direction must follow, the deceleration ramp becomes finished to $VACTUAL = 0$ first. Afterwards, the acceleration slope begins regularly. To avoid the unintentional finishing process of the deceleration ramp, set $VMAX < \text{abs}(VACTUAL)$. If $VMAX$ is reached now, set $VMAX$ to the requested first value.
The same procedure has to be used in velocity mode if $VMAX$ becomes decreased and increased again during the deceleration slope.
Very slow deceleration slopes ($DMAX \leq (VMAX / 20s)$) of trapezoidal ramps can result in an overdrive of the target position with an immediate subsequent ramp to overhaul target mismatch. To avoid this, please use a reasonable value for $VSTOP$.
- A $VACTUAL$ value which exceeds $VMAX$ can be result of register changes during an S-shaped ramp. This is, because the bows $B1$, $B2$, $B3$, and $B4$ are maintained during the ramp progress.
- If the requested conditions for the acceleration slope of an S-shaped ramp ($VSTART$ or $ASTART$, $BOW1$ and $BOW2$) do not fit to $VMAX$, the starting acceleration value $ASTART$ becomes altered. In case of misconfiguration at ramp start $AMAX$ or $VSTART$ have to be decreased in order to reach $XTARGET$.

FASTEST POSSIBLE SLOPE IN POSITIONING MODE

The fastest possible slopes are always performed if the phases B_{12} and/or B_{34} are not reached during a rising and/or falling S-shaped slope. Thus, the ramp maintains the maximum velocity V_{MAX} as long as possible in positioning mode until the falling slope finishes the ramp to reach $XTARGET$ exactly. The result is the fastest possible positioning ramp in matters of time.

8.2.3 Internal Ramp Generator Units

All parameter units are real arithmetical units. Therefore, it is necessary to set the CLK_FREQ register to the appropriate value in [Hz] which is given by the external clock. Any value between 4.2 MHz and 32 MHz can be chosen.

VELOCITY VALUES

V_{ACTUAL} is given as a 32 bit signed value with no decimal places. The unsigned velocity values V_{START} , V_{STOP} , and V_{BREAK} consist of 23 digits and 8 decimal places. V_{MAX} is a signed value with 24 digits and 8 decimal places. Velocity values are given in pulses per second [pps].

The maximum velocity V_{MAX} is restricted by the clock frequency. Values higher than $\frac{1}{2} \text{ puls} \cdot f_{CLK}$ are prohibited because of an incorrect $STPOUT$ output if V_{ACTUAL} exceeds this limit.

ACCELERATION VALUES

The unsigned values A_{MAX} , D_{MAX} , A_{START} , and D_{FINAL} consist of 22 digits and 2 decimal places. A_{ACTUAL} shows a 24 bit non decimal signed value. Acceleration and deceleration units are given in pulses per second² [pps²].

BOW PARAMETER VALUES

Bow values are unsigned 24 bit values without decimal places. They are given in pulses per second³ [pps³].

The following absolute minimum and maximum values are valid:

Value Classes	Velocity	Acceleration	Bow	Clock
Registers	V_{MAX} , V_{START} , V_{STOP} , V_{BREAK}	A_{MAX} , D_{MAX} , A_{START} , D_{FINAL}	$BOW1$, $BOW2$, $BOW3$, $BOW4$	CLK_FREQ (f_{CLK})
Minimum	3.906250 mpps	0.250000 mpps ²	1 mpps ³	4.194304 MHz
Maximum	8.388607 mpps $\frac{1}{2} \text{ puls} \cdot f_{CLK}$	4.194303 mpps ²	16.777 mpps ³	32MHz

SHORT AND STEEP RAMPS

For short and steep ramps higher acceleration/deceleration and bow values than usual are available by activating $direct_acc_val_en$ and $direct_bow_val_en$ (see *generator configuration register*, chapter 17.1). Set these parameters to 1 to change the units:

$direct_acc_val_en=1$ The values for A_{MAX} , D_{MAX} , A_{START} , D_{FINAL} , and D_{STOP} (see chapter 9) are given as velocity value change per clock cycle with 24 bit unsigned decimal places (MSB = 2^{-14}).

$direct_bow_val_en=1$ Bow values are given as acceleration value change per clock cycle. The values $BOW1$, $BOW2$, $BOW3$, and $BOW4$ are 24 bit unsigned decimal places with the MSB defined as 2^{-29} .

EXAMPLE

With a clock frequency $f_{CLK}=16$ MHz the following maximum values are valid:

Value Classes	Acceleration ($direct_acc_val_en=1$)	Bow ($direct_bow_val_en=1$)
Registers	A_{MAX} , D_{MAX} , A_{START} , D_{FINAL} , D_{STOP}	$BOW1$, $BOW2$, $BOW3$, $BOW4$
Calculation	$a[\text{pps}^2] = (\Delta v / \text{clk_cycle}) / 2^{37} \cdot f_{CLK}^2$	$\text{bow}[\text{pps}^3] = (\Delta a / \text{clk_cycle}) / 2^{53} \cdot f_{CLK}^3$
Minimum	-1.86 kpps ²	-454.75 kpps ³
Maximum	-31.25 Gpps ²	-7.63 Tpps ³

9 Reference Switches

The reference input signals of the TMC4361 can be considered as a safety feature. The TMC4361 provides different possibilities for reference switches and allows for appropriate settings for various applications. The TMC4361 offers two switches in hardware (STOPL, STOPR) and two additional virtual stop switches (VIRT_STOP_LEFT, VIRT_STOP_RIGHT). Additionally, a home reference switch is available.

PINS AND REGISTERS: REFERENCE SWITCHES

Pin names	Type	Remarks	
STOPL	Input	Left reference switch	
STOPR	Input	Right reference switch	
HOME_REF	Input	Home switch	
TARGET_REACHED	Output	Reference switch to indicate XACTUAL=XTARGET	
Register name	Register address	Remarks	
REFERENCE_CONF	0x01	RW	Configuration of interaction with reference pins
HOME_SAFETY_MARGIN	0x1E	RW	Region of uncertainty around X_HOME
DSTOP	0x2C	RW	Deceleration value if stop switches STOPL/STOPR or virtual stops are used with soft stop ramps. The deceleration value allows for an automatic linear stop ramp.
POS_COMP	0x32	RW	Free configurable compare position; signed; 32 bits
VIRT_STOP_LEFT	0x33	RW	Virtual left stop that triggers a stop event at $XACTUAL \leq VIRT_STOP_LEFT$; signed; 32 bits
VIRT_STOP_RIGHT	0x34	RW	Virtual right stop that triggers a stop event at $XACTUAL \geq VIRT_STOP_RIGHT$; signed; 32 bits
X_HOME	0x35	RW	Home reference position; signed; 32 bits
X_LATCH	0x36	RW	Stores XACTUAL at different conditions; signed; 32 bits

9.1 STOPL and STOPR

A left and a right stop switch are provided in hardware in order to stop the drive immediately, if one of them is triggered. Therefore, pin 12 and pin 14 of the motion controller have to be used. Both switches have to be enabled first:

- To use STOPL set *stop_left_en*=1. Now, the current velocity ramp stops in case STOPL is equal to the chosen active polarity *pol_stop_left* and $VACTUAL < 0$.
- To use STOPR set *stop_right_en*=1. Now, STOPR stops the ramp in case the STOPR voltage level matches *pol_stop_right* and $VACTUAL > 0$.

The deceleration slope for stopping the ramp is influenced by *soft_stop_en*:

- Set *soft_stop_en*=0 for a hard and quick stop.
- Set *soft_stop_en*=1 to stop the ramp with a linear falling slope. In this case the deceleration factor is determined by *DSTOP.VSTOP* is not considered during the stop deceleration slope.

At the same time when a stop switch becomes active, the related status flag will be set and the particular event will be released. The flag remains set as long as the stop switch remains active. After reaching $VACTUAL=0$ due to the slope, further movement in the particular direction is not possible.

Driving on in the direction of a reference switch is possible if the following conditions are met:

- The related status event is set back. The reference switch is not active anymore or alternatively, the related enabling switch (*stop_left_en*, *stop_right_en*) is reset to 0 (switched off) to go on driving in the - prior to that - closed direction.
- Stop events are cleared by reading out the *EVENTS* register. This is done automatically by the motion controller subsequent to an SPI datagram read request to this register. (There is only one exception to this if an event is selected for the *EVENT_CLEAR_CONF* register in order to inhibit the regular clearing.)

9.1.1 Configurations

Four different events can be chosen to latch the current internal position *XACTUAL* in the register *X_LATCH*. The following events and reference configurations result in such a transfer with an event indicating the latching process:

Reference configuration	<i>pol_stop_left=0</i>	<i>pol_stop_left=1</i>	<i>pol_stop_right=0</i>	<i>pol_stop_right=1</i>
<i>latch_x_on_inactive_l=1</i>	STOPL=0 → 1	STOPL=1 → 0	---	---
<i>latch_x_on_active_l=1</i>	STOPL=1 → 0	STOPL=0 → 1	---	---
<i>latch_x_on_inactive_r=1</i>	---	---	STOPR=0 → 1	STOPR = 1→0
<i>latch_x_on_active_r=1</i>	---	---	STOPR=1 → 0	STOPR = 0→1

Setting *invert_stop_direction=1* swaps STOPL and STOPR. Thus, all configuration parameters for STOPL become valid for STOPR and vice versa.

9.2 Virtual Stop Switches

The TMC4361 provides additional virtual limits which trigger stop slopes in case the specific virtual stop switch microstep position is reached. Virtual stop positions can be set using *VIRTUAL_STOP_LEFT* and *VIRTUAL_STOP_RIGHT* which are part of the *Target and Compare Register* (see chapter 17.17).

Virtual stop switches have to be enabled like non-virtual reference switches. Therefore, set *virtual_left_limit_en* respectively *virtual_right_limit_en* to 1. Hitting a virtual limit switch triggers the same process as hitting STOPL or STOPR.

At the same time when a virtual stop switch becomes active an event becomes released which has to be cleared in any case before further movement in the particular direction can be performed again.

Driving on in the direction of a virtual switch after a stop event is possible if the following conditions are met:

- For further movement in negative direction choose a new value for *VIRTUAL_STOP_LEFT* or set *virtual_left_limit_en=0*.
- For further movement in positive direction choose a new value for *VIRTUAL_STOP_RIGHT* or set *virtual_right_limit_en=0*.

The deceleration slope can be chosen with *virt_stop_mode*:

- Set *virt_stop_mode= b'01* for a hard and quick stop.
- Set *virt_stop_mode= b'10* to stop the ramp with a linear falling slope. In this case the deceleration factor is determined by *DSTOP*.
- Set *virt_stop_mode= b'00* to stop the ramp with the currently chosen ramp type. In this case the actual ramp parameter set *DMAX* and *DFINAL* determine the deceleration ramp. Note, that for S-shaped ramps, BOW3 and BOW4 are valid, too.

Attention

invert_stop_direction has no influence on *VIRTUAL_STOP_LEFT* resp. *VIRTUAL_STOP_RIGHT*.





9.3 HOME Reference

For monitoring, the switch reference input HOME_REF is provided.

HOMING PROCESS

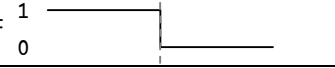
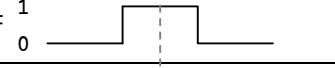
- Enable the tracking mode with *start_home_tracking=1*.
- With the next home event *XACTUAL* is latched to *X_HOME*.
- The switch *start_home_tracking* of the REFERENCE_CONF register is automatically reset to 0.
- An error flag is permanently evaluated. This error flag indicates whether the current voltage level of the HOME_REF reference input is valid in respect to *X_HOME* and the chosen *home_event*.

Nine different home events are possible. Besides *home_event* = b'0000 which uses the N signal of an incremental ABN encoder, the following home events can be used. Therefore, configure the four *home_event* bits which are part of the reference switch configuration register (see chapter 17.2)

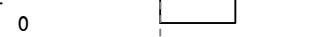
home_event	Description	X_HOME (direction: negative/positive)
b'0011	HOME_REF = 0 indicates negative direction in reference to X_HOME	HOME_REF 1 0 
b'1100	HOME_REF = 0 indicates positive direction in reference to X_HOME	HOME_REF 1 0 
b'0110	HOME_REF = 1 indicates home position	X_HOME in center HOME_REF 1 0 
b'0010		X_HOME at the left side HOME_REF 1 0 
b'0100		X_HOME at the right side HOME_REF 1 0 
b'1001	HOME_REF = 0 indicates home position	X_HOME in center HOME_REF 1 0 
b'1011		X_HOME at the right side HOME_REF 1 0 
b'1101		X_HOME at the left side HOME_REF 1 0 

DEFINING AN UNCERTAINTY AREA AROUND X_HOME

Use the register *HOME_SAFETY_MARGIN* for defining an uncertainty area around *X_HOME*. Then, homing uncertainties related to the special application environment are considered for the further process. There will be no error flag generated if two conditions are met:

$$X_{ACTUAL} = X_{HOME} - HOME_SAFETY_MARGIN \text{ and } X_{ACTUAL} = X_{HOME} + HOME_SAFETY_MARGIN$$

The following examples (see Figure 9.1.) show the points at which - dependent on the chosen *home_event* - an error flag is generated.

It is recommended to set the *HOME_SAFETY_MARGIN* bigger than the period during which the *HOME_REF* level is active for the *home_events* b'0110, b'0010, b'0100, b'1001, b'1011, and b'1101. This is necessary to avoid wrong *HOME_ERROR_Flags*.

After homing with the N channel (*home_event* = b'0000) for a precise assignment of *X_HOME* the correct *home_event* has to be assigned in order to activate the generation of *HOME_ERROR_Flags*. Note that *home_event* = b'0000 results in *HOME_ERROR_Flag=0* permanently.

Attention

If the homing process is based on the n event (*home_event* = b'0000), *latch_enc_on_n* has to be set as well as *clr_latch_cont_on_n* or *clr_latch_once_on_n*. Refer to chapter 14.2.1 for further information about the switches.

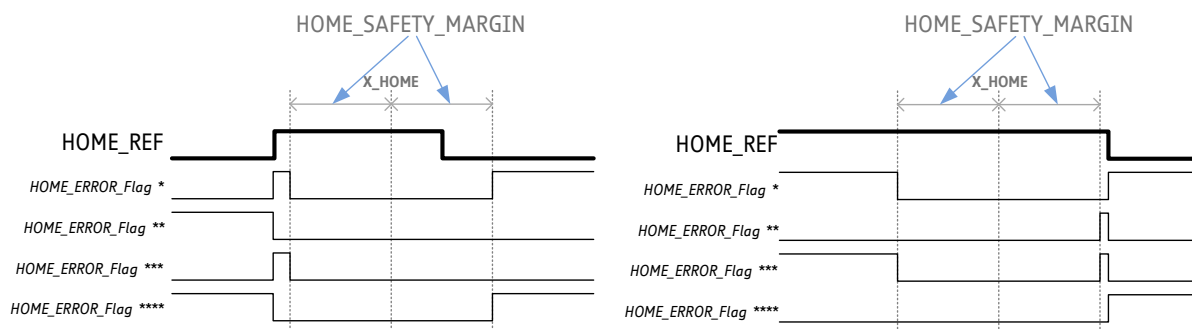

Figure 9.1 *HOME_REF* monitoring and *HOME_ERROR_FLAG*

The two examples above illustrate *HOME_REF* monitoring and generation of the *HOME_ERROR_Flag* for *home_event* = b'0011 (*), b'1100 (**), b'0110 (***), b'0010 (***), b'0100 (***), b'1001 (****), b'1011 (****), and b'1101 (****).

HOMING WITH STOPL AND STOPR

STOPL and STOPR inputs can also be used as *HOME_REF* inputs. Therefore set the *REFERENCE_CONF* register bits *stop_left_is_home*=1 respectively *stop_right_is_home*=1. This leads to a stop of the current ramp only after STOPL or STOPR is switching to active state and the home uncertainty region is crossed. The home uncertainty region is given by *X_HOME* and *HOME_SAFETY_MARGIN*.

9.4 Cyclic Movement to XTARGET

Usually, reaching *XTARGET* in positioning mode finishes a velocity ramp. To repeat the current ramp with its specified parameters steadily set *clr_pos_at_target* to 1. Until velocity mode is chosen or *clr_pos_at_target* is set to 0, *XACTUAL* will be reset to 0 if *XTARGET* is reached (*XACTUAL* = *XTARGET*). Normally, the falling slope to stop the ramp is performed within each ramp cycle.

TRIGGERING FURTHER RAMPS IDENTICAL TO THE FIRST ONE (POSITIONING MODE ONLY)

- Set *clr_pos_at_target*=1
- Set *XTARGET*.
- Now, *XACTUAL* is set to 0 automatically if *XTARGET* is reached.
- Another velocity ramp for reaching *XTARGET* becomes active now.

9.5 Target Reached / Position Comparison

The *TARGET_REACHED* pin 31 forwards the *TARGET_REACHED_Flag*. Thus, if *XACTUAL* = *XTARGET*, *TARGET_REACHED* is active. The polarity can be configured via *invert_pol_target_reached* switch of the *GENERAL_CONF* register. The output pin can also be used to indicate the status of the *POS_COMP_REACHED_Flag* which is generated if the *POS_COMP* register value is equal to *XACTUAL* or *ENC_POS*.

OVERVIEW: SETTINGS FOR POSITION COMPARISON

- Choose a *POS_COMP* value. The position compare register provides 32 bits.
- Choose a compare parameter by setting *pos_comp_source*.
 - Set *pos_comp_source*=1 for *ENC_POS*.
 - Set *pos_comp_source*=0 for *XACTUAL*.

The position compare process is permanently active. The stored *POS_COMP* position is compared with *XACTUAL* respectively *ENC_POS* automatically. If *POS_COMP* = *XACTUAL* the status flag *POS_COMP_REACHED_F* becomes set and the *POS_COMP_REACHED* event becomes released, provided that switching to active state is done first.

- Additional, the output *TARGET_REACHED* can be used to report the state of position comparison instead of the target reached status. Therefore, set *pos_comp_output* = b'11.

10 Ramp Timing & Synchronization

The TMC4361 provides various possibilities for ramp timing. Usually, every external register change via an SPI input is assigned immediately to the internal registers. With a proper start configuration of the TMC4361, ramp sequences without any intervening in between can be programmed. Various possibilities result from choosing different target positions, which can be predefined and successively activated, combined with the opportunity of a cyclic pipeline. Therefore, it is necessary to understand ramp start configurations, triggers, and consequences.

PINS AND REGISTERS: SYNCHRONIZATION

Pin names	Type		Remarks
START	Input and Output		External start input to get a start signal or external start output to indicate an internal start event.
Register name	Register address		Remarks
START_CONF	0x02	RW	The configuration register of the synchronization unit
START_OUT_ADD	0x11	RW	Additional active output length of external start signal
START_DELAY	0x13	RW	Delay time between start trigger and signal
X_PIPE0... 7	0x38...0x3F	RW	Target positions pipeline

10.1 Start Signal Generation

A ramp can be initiated using an internal or an external start trigger for the start signal generation. Note that a start trigger is not the start signal itself but the transition slope to the active start state. Now, for ramp start configuration consider the following steps:

1. Choose internal or external start trigger(s).
2. Adjust the timing of the start signal after a start trigger has been recognized.
3. Enable start signal processing.

10.1.1 Starting a Ramp via an Internal Start Trigger

There are different triggers available for an internal start signal. These triggers are assigned by the *trigger_events* switches (bits 5...8) of the *START_CONF* register. Every bit of *trigger_event* can be selected separately. Thus, more than one signal can trigger a start event.

<i>trigger_events</i> (8 : 5)	Description
b'xxx0	Set bit 5 to 0 for internal start trigger only. The START pin as output. (If bit 5 is set to 1, an external trigger is chosen and the START pin is used as input)
b'xx1x	TARGET_REACHED event is assigned as start signal for timer
b'x1xx	VELOCITY_REACHED event is assigned as start signal for timer
b'1xxx	POSCOMP_REACHED event is assigned as start signal for timer

10.1.2 Starting a Ramp via an External Start Trigger

Set *Start_en*(0) = 1 to use external start signals. Further, there is one specific bit that has to be set for using an external trigger:

<i>trigger_events</i> (8 : 5)	Description
b'xxx1	Set bit 5 to 1 for an external start trigger. Use the START pin as input now.

DEFINING THE ACTIVE VOLTAGE LEVEL OF THE START PIN

The active voltage level of the START pin is defined by *pol_start_signal*.

EXAMPLES

1. Set *pol_start_signal*=0 and *trigger_events*(0)=*start_en*(0)=1

Now, the voltage level transition from high to low triggers a start signal. The signal is further processed by the synchronization unit.

2. Set *pol_start_signal* = 1 and *trigger_events*(0) = 0

Now, start is used as output forwarding internal start signals with a high active level.

External start signals have to be filtered. The filter length must exceed *START_OUT_ADD* clock cycles!

10.1.3 *start_en*Settings

To enable a start signal for a ramp it is necessary to set *start_en* which is part of the *START_CONF* register. By setting *start_en*, the impact of generated start signals on the internal ramps is specified.

A start signal can be used in different ways:

<i>start_en</i> (2 : 0)	Description
b'000	No start signal will be generated or processed further.
b'xx1	<i>XTARGET</i> is altered only after a start signal.
b'x1x	<i>VMAX</i> is altered only after a start signal.
b'1xx	<i>RAMPMODE</i> can be changed after a start signal.

10.1.4 Adjustments Related to Start Signal Timing and Prioritizing

Every start switch can be enabled and disabled separately. In case an enable switch is set low, the particular register is changed immediately if the register is assigned by an SPI datagram. Using enable switches allows for setting specific points in time for altering register values. Thus, the assignment of SPI requests to the registers *XTARGET*, *VMAX* and *RAMP_MODE* can be uncoupled from the SPI transfer itself. The assignment can be combined with trigger events which are related to the internal start signal generation.

***START_DELAY* – setting a delay time for the start signal after a trigger**

For delaying an immediate ramp start set *START_DELAY* (31 : 0) to a reasonable value. Then, the chosen *START_DELAY* value defines the time interval between the recognition of the chosen start trigger(s) and the internal start signal generation. For switching off a chosen start delay time set *start_en* = b'000.

***immediate_start_in*– prioritizing the external *START* signal**

For prioritizing the external *START* signal opposed to all other triggers set *immediate_start_in* = 1. Thus, an external *START* is executed immediately after its recognition independently from a given *START_DELAY* time, an active timer, or other triggers.

Synchronizing Several Motion Controllers

Due to the fact that the start pin can be assigned as input or output synchronization between several motion controllers is feasible. Besides the setup of several TMC4361 as slaves and one master μ C which can initiate velocity ramps of the slave devices concurrently, it is possible to use the internal start signal of a TMC4361 as external trigger for other motion controllers. Assigning the start pin as output, one *master TMC4361* can forward its internal start signal (e.g. due to a target reached event) to trigger register changes for other motion controllers which act as slaves under this condition. Therefore, *START_OUT_ADD* can be set appropriately to prolong the active start signal because otherwise the start signal activated at the start pin as output only lasts for one clock cycle.

The active polarity of the external start signal can be configured by *pol_start_signal*. It is valid for both configurations of the start pin (input or output).

If an external start trigger is not used and the *START* pin is also not used for communication with an external device, connect it to GND and select *pol_start_signal* = 1. Alternatively, connect *START* to V_{10} supply and set *pol_start_signal*=0. Additionally, choose the value 7 for *FILT_L_S* and *SR_S*.

10.1.5 Examples for Ramp Timing

The following three examples depict SPI datagrams, internal and external signal levels, corresponding velocity ramps, and additional explanations. SPI data is transferred internally at the end of each datagram.

EXAMPLE 1

Parameter	Setting	Description
<i>RAMPMODE</i>	b'101	The velocity value change is executed immediately. The new <i>XTARGET</i> value is assigned after <i>TARGET_REACHED</i> has been set and <i>START_DELAY</i> has been expired. A new ramp does not start at the end because there is no new <i>XTARGET</i> value assigned. <i>START</i> is used as output. The internal start signal is forwarded with a step length of (<i>START_OUT_ADD</i> +1) clock cycles. This way, external devices can be synchronized.
<i>start_en</i>	b'001	
<i>trigger_events</i>	b'0010	
<i>START_DELAY</i>	>0	
<i>START_OUT_ADD</i>	>0	
<i>pol_start_signal</i>	1	

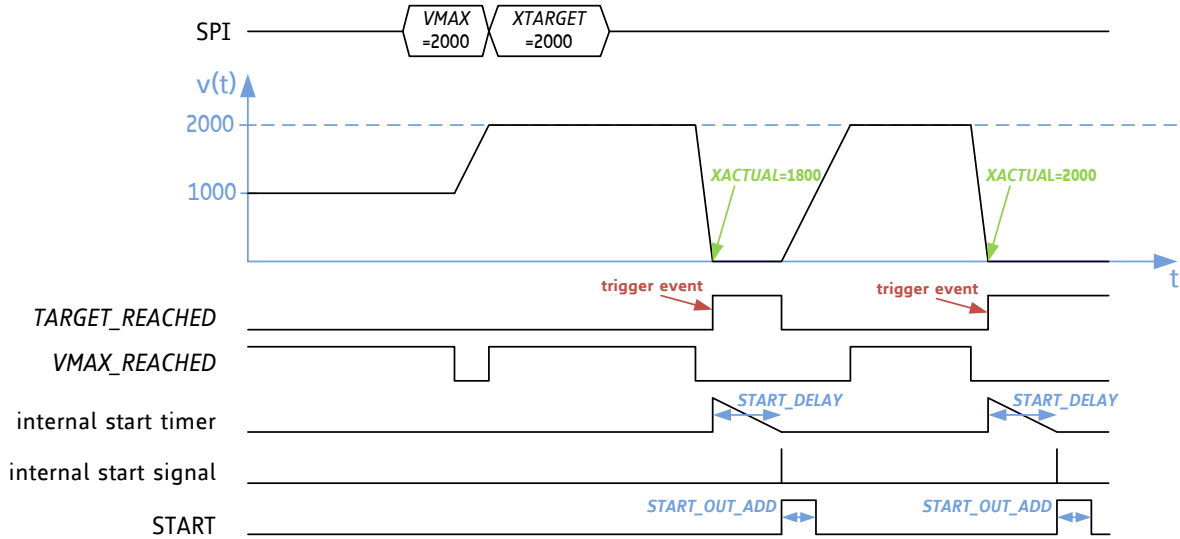

Figure 10.1Start example 1

EXAMPLE 2

Parameter	Setting	Description
<i>RAMPMODE</i>	b'001	The velocity value and ramp mode value change will be executed after the first start signal. Because of the new ramp mode positioning mode and S-shaped ramps are activated and the ramp stops at target position. Due to a further target request, the ramp starts again. The active $START$ output signal lasts only one clock cycle.
<i>start_en</i>	b'111	
<i>trigger_events</i>	b'0110	
<i>START_DELAY</i>	>0	
<i>START_OUT_ADD</i>	0	
<i>pol_start_signal</i>	0	

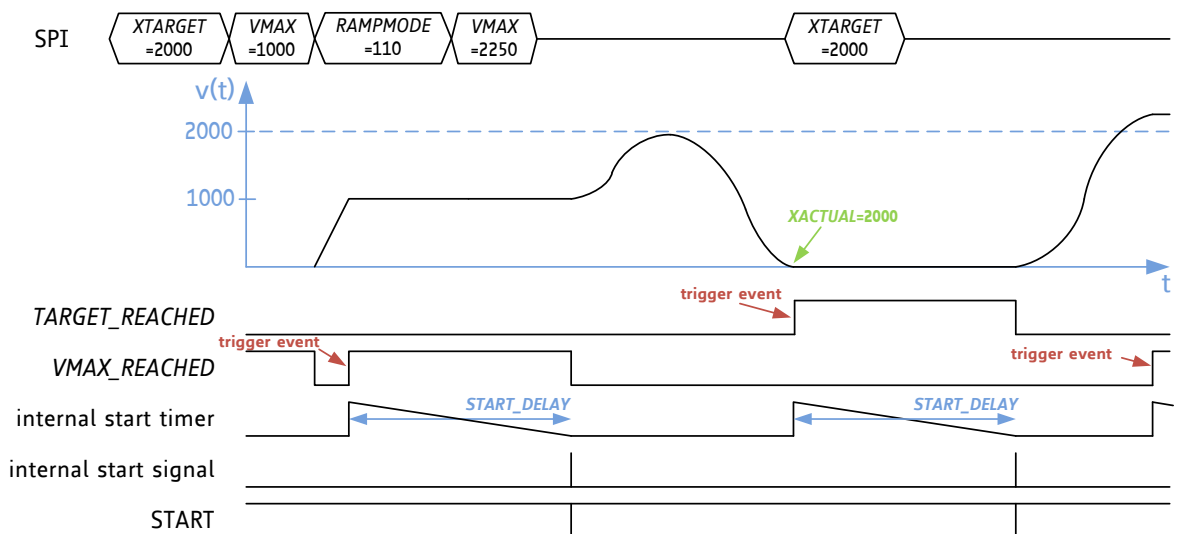

Figure 10.2Start example 2

EXAMPLE 3

For this example start signal triggers have been prioritized due to the use of start timing via a *START_DELAY* setting and due to the setting *immediate_start_in=1*.

Parameter	Setting	Description
<i>RAMPMODE</i>	b'000	When <i>XACTUAL</i> = <i>POSCOMP</i> the start timer is activated and the external start signal in between is ignored.
<i>start_en</i>	b'010	
<i>trigger_events</i>	b'1001	
<i>immediate_start_in</i>	0	The second start event is triggered due to the external start signal. The <i>POSCOMP_REACHED</i> event is ignored.
<i>START_DELAY</i>	>0	The third start timer process is disrupted by the external <i>START</i> signal which is forced to be executed immediately due to the setting <i>immediate_start_in</i> = 1.
<i>pol_start_signal</i>	1	

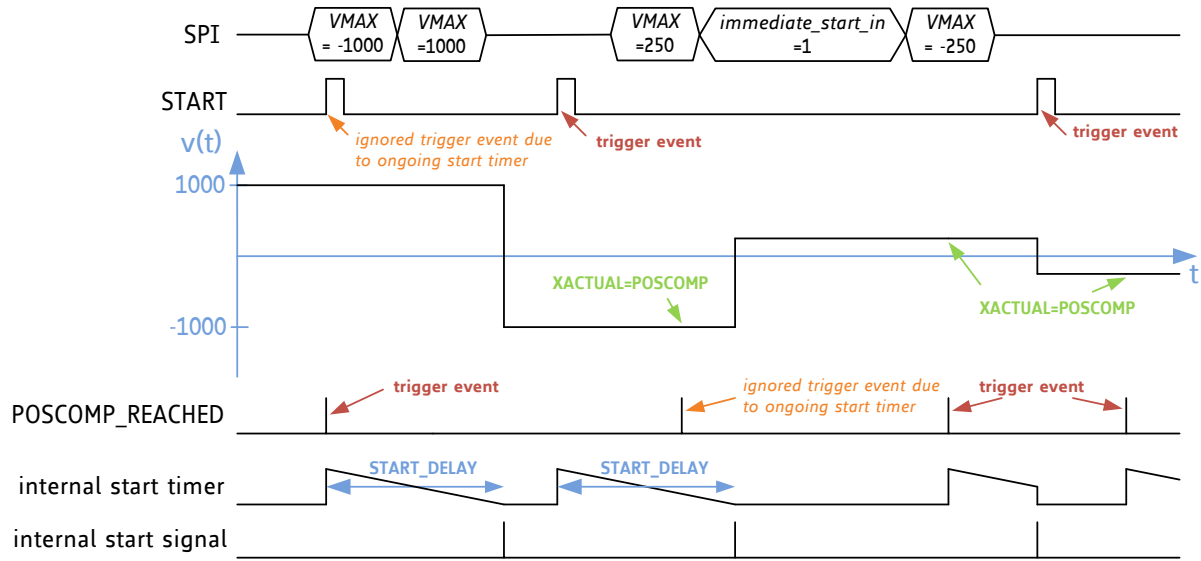

Figure 10.3 Startexample 3

10.2 Target Pipeline

The TMC4361 provides a target pipeline for sequencing subordinated targets during the drive. This way, a complex target structure can be easily arranged.

PROCEED AS FOLLOWS:

- Set $x_pipeline_en=1$.
- Set $start_en(0)=1$.
- Now, the value in X_PIPE0 becomes transferred to $XTARGET$ at the next internal start signal.
- The complete target pipeline $X_PIPE0... X_PIPE7$ becomes shifted forward step by step following the condition $X_PIPE_n = X_PIPE_{n+1}$.

This flexible target pipeline provides up to eight additional target positions which become transferred at the next specific start signal. The actually valid target position is written back to X_PIPE_x , where x is equal to the bit position of $x_pipe_rewrite_reg$. More precisely, if $x_pipe_rewrite_reg = b'00010000$, $X_PIPE4 = XACTUAL$ at the next internal start signal. If $x_pipe_rewrite_reg = b'00000000$, $XTARGET$ will not be written back to any X_PIPE_n register. If multiple bits are set, $XTARGET$ will be written back to each of the selected X_PIPE_n registers.

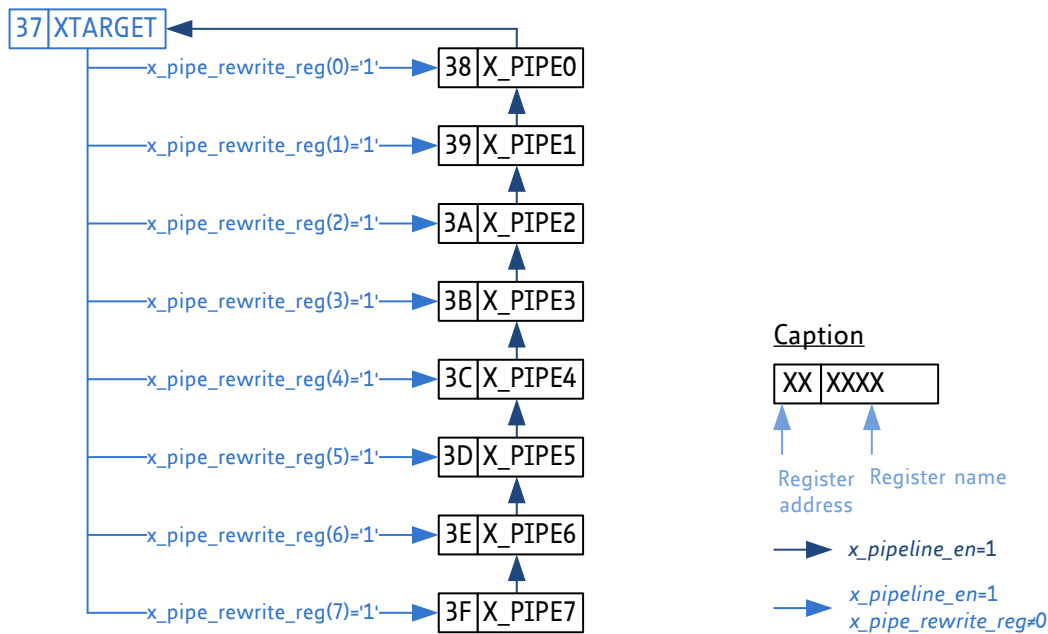

Figure 10.4 Flexible target pipeline

11 Serial Data Output

The TMC4361 provides an SPI interface for initialization and configuration of the motor driver (additional to the Step/Dir output) before and during motor motion. Furthermore, it is possible to control TRINAMIC stepper drivers during SPI motor drive. The SPI interface is used for principal tasks:

- Two current values of the integrated sine wave look-up table can be transferred at a time to the driver chip in order to energize the motor coils. This is done within each SPI datagram. A series of current values is transferred to move the motor. Values of the MSLUT (microstep sine wave look-up table) are adjusted using velocity ramp dependent scale values. This way, maximum amplitude current values are aligned to the requirements of certain velocity slopes.
- The TMC4361 integrates an adjustable cover register for configuration purposes. This way, TRINAMIC motor driver chips and third parties chips can be adjusted with only little effort.

PINS AND REGISTERS: SPI TO MOTOR DRIVER

Pin names	Type		Remarks
NSCSDRV_SDO	Output		Chip select output to motor driver, low active
SCKDRV_NSDO	Output		Serial clock output to motor driver
SDODRV_SCLK	InOut as Output		Serial data output to motor driver
SDIDRV_NSCLK	Input		Serial data input from motor driver
STDBY_CLK	Output		Clock output, standby output, or ChopSync clockoutput
Register name	Register address		Remarks
GENERAL_CONF	0x00	RW	Bit14 : 13, bit19, bit20
REFERENCE_CONF	0x01	RW	Bit26, bit27
SPIOUT_CONF	0x04	RW	Configuration register for SPI output communication
CURRENT_CONF	0x05	RW	Current scaling configuration
SCALE_VALUES	0x06	RW	Current scaling values
STEP_CONF	0x0A	RW	Microsteps/fullstep,fullstep/revolution, and motor status bit event selection
STDBY_DELAY	0x15	RW	Delay time after standby mode is valid
FREEWHEEL_DELAY	0x16	RW	Delay time after freewheeling is valid
VDRV_SCALE_LIMIT	0x17	RW	Velocity setting for changing the drive scale value
UP_SCALE_DELAY	0x18	RW	Increment delay to a higher scaling value; 24 bit
HOLD_SCALE_DELAY	0x19	RW	Decrement delay to the hold scaling value; 24 bit
DRV_SCALE_DELAY	0x1A	RW	Decrement delay to the drive scaling value
BOOST_TIME	0x1B	RW	Delay time after ramp start when boost scaling is valid
DAC_ADDR	0x1D	RW	SPI addresses/commands which are put in front of the DAC values: Coil A: DAC_ADDR (bit 15 : 0) Coil B: DAC_ADDR (bit 31 : 16)
CHOPSYNC_DIV	0x1F	RW	Chopper clock divider (bit 11 : 0)
FS_VEL	0x60	W	Velocity at which fullstep drive will be enabled
COVER_LOW	0x6C	W	Lower 32 bit of the cover register (μ C to motor driver)
COVER_HIGH	0x6D	W	Upper 32 bit of the cover register (μ C to motor driver)
COVER_DRV_LOW	0x6E	R	Lower 32 bit of the cover register (motor driver to μ C)
COVER_DRV_HIGH	0x6F	R	Upper 32 bit of the cover register (motor driver to μ C)
MSLUT[0...7]	0x70...77	W	Difference values between two consecutive MSLUT values
MSLUTSEL	0x78	W	Definition of segments within each MSLUT quarter wave
Register name	Register address		Remarks
MSCNT	0x79	R	Current microstep position of the MSLUT
CURRENTA CURRENTB	0x7A	R	Actual current values of the MSLUT: SIN (coil A) and SIN90_120 (coilB); each 9 bit
CURRENTA_SPI CURRENTB_SPI	0x7B	R	Actual scaled current values of the MSLUT: SIN (coil A) and SIN90_120 (coilB); each 9 bit
SCALE_PARAM	0x7C	R	Actual scaling parameter; 8 bit
START_SIN START_SIN90_120 DAC_OFFSET	0x7E	RW	Sine start value of the MSLUT (bit 7 : 0) Cosine start value of the MSLUT (bit 23 : 16) Offset value for DAC output values (bit 31 : 24)

Note

For a good start with a TRINAMIC motor driver, setup *SPIOUT_CONF* register properly. Thus, the TMC4361 offers presets for current transfer and automatic configuration routines if the correct driver is selected. Status bits of TMC motor drivers are transmitted to the status register of the motion controller.

11.1 Sine Wave Look-up Table

TMC4361 provides a programmable look-up table for storing the microstep current wave. As a default, the tables are pre-programmed with a sine wave, which is a good starting point for most stepper motors. Reprogramming the table to a motor specific wave allows drastically improved microstepping especially with low-cost motors. In order to minimize required memory and the amount of data to be programmed, only a quarter of the wave becomes stored. The internal microstep table maps the microstep wave from 0° to 90°. It becomes symmetrically extended to 360°. When reading out the table the 10-bit microstep counter *MSCNT* addresses the fully extended wave table. The table is stored in an incremental fashion, using each one bit per entry. Therefore only 256 bits (*ofs00* to *ofs255*) are required to store the quarter wave. These bits are mapped to eight 32 bit registers.

Each *ofs* bit controls the addition of an inclination W_x or W_{x+1} when advancing one step in the table. As the wave can have a higher inclination than 1, the base inclinations W_x can be programmed to -1, 0, 1, or 2 using up to four flexible programmable segments within the quarter wave. This way, even a negative inclination can be realized. The four inclination segments are controlled by the position registers *X1* to *X3*.

When modifying the wave, care must be taken to ensure a smooth and symmetrical zero transition when the quarter wave becomes expanded to a full wave. The maximum resulting swing of the wave should be adjusted to a range of -248 to 248, in order to give the best possible resolution while leaving headroom for the hysteresis based chopper to add an offset.

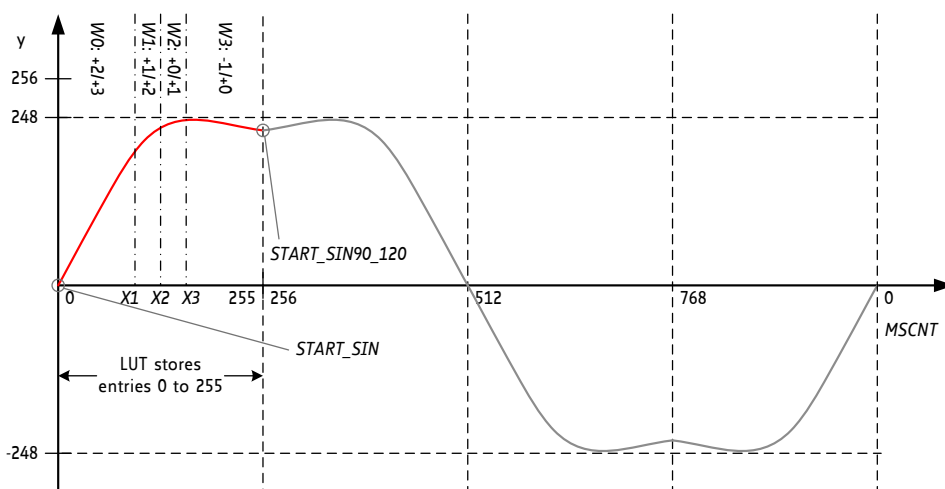

Figure 11.1 LUT programming example

When the microstep sequencer advances within the table, it calculates the actual current values for the motor coils with each microstep and stores them to the registers *CURRENTA* and *CURRENTB*. However the incremental coding requires an absolute initialization, especially when the microstep table becomes modified. Therefore, *CURRENTA* and *CURRENTB* become initialized whenever *MSCNT* passes zero.

TWO REGISTERS CONTROL THE STARTING VALUES OF THE TABLES:

- As the starting value at zero is not necessarily 0 (it might be 1 or 2), it can be programmed into the starting point register *START_SIN*.
- In the same way, the start of the second wave for the second motor coil needs to be stored in *START_SIN90_120*. This register stores the resulting table entry for a phase shift of 90° for 2-phase stepper motors.

11.1.1 Programming the Incremental Microstep Table

For understanding the background of the incremental coding of the microstep table, it is good to have an idea of the characteristics of the microstep wave.

A MICROSTEP TABLE FOR A TWO PHASE MOTOR HAS CERTAIN CHARACTERISTICS:

1. It is in principle a reverse characteristic of the motor pole behavior.
2. It is a smoothened wave to provide a smooth motor behavior. There are no jumps within the wave.
3. The phase shift between both phases is exactly 90°, because this is the optimum angle of the poles within the motor.
4. The zero transition is at 0°. The curve is symmetrical within each quadrant (like a sine wave).
5. The slope of the wave is normally positive, but due to torque variations it can also be (slightly) negative.
6. But it must not be strictly monotonic as the example in the previous chapter shows.

Considering these facts, it becomes clear that the wave table can be compressed. The incremental coding used in the TMC4361 uses a format which reduces the required information per entry of the 8 bit by 256 entry wave table to slightly more than a single bit.

INCREMENTAL ENCODING

The principle of incremental encoding just stores the difference between the actual and the next table entry. To have an absolute start value, the first entry is directly stored (*START_SIN*). For the ease of use, also the first entry of the shifted table for the second motor phase is stored (*START_SIN_90_120*). The TMC4361 provides four inclination segments (0, 1, 2, and 3) with the base inclinations (*W0*, *W1*, *W2*, and *W3*) and the segment borders (0, *X1*, *X2*, *X3*, and 255).

Inclination segment	Base inclination	Segments
0	W0	0... X1
1	W1	X1... X2
2	W2	X2... X3
3	W3	X3... 255

Table 11.1 Inclination segments of TMC4361

EXPLANATORY NOTES AND EXAMPLES

Using a single bit per table entry allows any inclination between 0 and 1. E.g., a *0-bit* can mean *do not add anything* and a *1-bit* can mean *add one*. This allows describing a digital slope of 0° (all bits zero) to 45° (all bits one).

It becomes clear, that higher inclinations are necessary. However, the inclination will not drastically change from point to point. Therefore, the wave can be divided into up to four segments with different base inclinations.

Using a base inclination of one, a *0-bit* means *add one* and a *1-bit* means *add two*. This way, a slope between 45° (all bits zero) and 77.5° is yielded (all bits one).

The base inclinations can be set between -1 (falling slope) and +2. This way, slopes between -45° and 78.75° can be described.

The default sine wave table in TRINAMIC drivers uses one segment with a base inclination of 1 and one segment with a base inclination of 0.

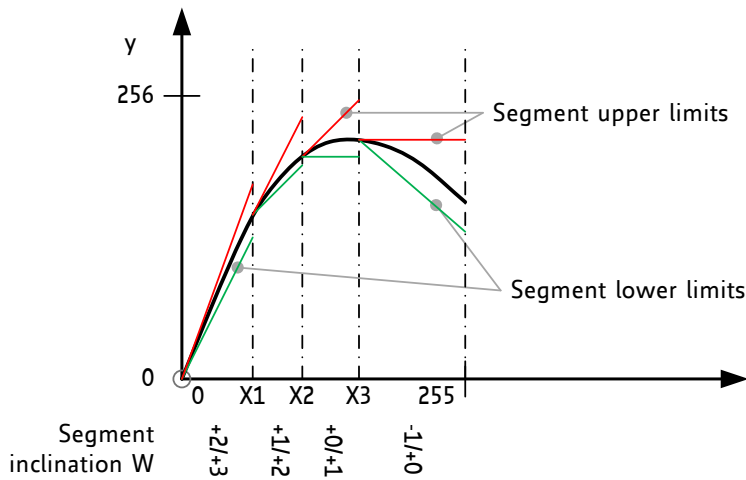

Figure 11.2 Wave showing segments with all possible base inclinations (highest inclination first)

EXAMPLE

CONSIDER THE GIVEN CONDITIONS:

The microstep table for the standard sine wave begins with the eight entries (0 to 7) {0, 1, 3, 4, 6, 7, 9, 10 ...} etc.

The maximum inclination in this area is 2 (1+2=3).

The minimum inclination in these eight entries is 1.

The start value is 0.

Advancing in the table, the first time the inclination becomes lower than +1 is from position 153 to position 154. Both entries are identical.

The calculated value for position 256 (start of cosine wave) is 247.

THEREFORE, THE FOLLOWING SETTINGS NEED TO BE MADE:

- Set a starting value *START_SIN*=0 matching sine wave entry 0.
- Set a base inclination range of *W0*: +1 / +2 (*W0*=%10), valid from 0 to *X1*.
- Calculate the differences between each two entries: {+1, +2, +1, +2, +1, +2, +1,...}
- Set the microstep table entries *ofsxx* to 0 for the lower value (+1), 1 for the higher value (+2). Thus, the first seven microstep table entries *ofs00* to *ofs06* are: {0, 1, 0, 1, 0, 1, 0 ...}
- Latest at position 153, the inclination must be lowered. Use the next inclination range 1 with *W1*: +0 / +1 (*W1*=%01). Therefore, *X1* becomes set to 153 in order to switch to the next inclination range. Thus, starting from position 153, an offset *ofsxx* of 0 means add nothing, 1 means add +1.
- *START_SIN90_120* becomes equal to the value at position 256, i.e. 247.
- As the wave does not more have segments with different inclinations, the remaining inclination ranges *W2* and *W3* shall be set to the same value as *W1*, and *X2* and *X3* can be set to 255. This way, only two inclination segments are effective.

OVERVIEW OF EXAMPLE												
Microstep number	0	1	2	3	4	5	6	7	...	153	154	...
Desired table entry	0	1	3	4	6	7	9	10	...	200	200	...
Difference to next entry	1	2	1	2	1	2	1	0
Required segment inclination	+1	+1	+1	+1	+1	+1	+1	+0
Offs bit entry	0	1	0	1	0	1	0	0

11.2 SPI Output Parameters

The TMC4361 provides SPI output parameters to adjust a proper communication with the motor driver. Set `serial_enc_out_enable=0` to enable the SPI output communication. The TMC4361 generates the necessary SPI output clock frequency and forwards it to the SCKDRV_NSDO output pin. The low phase of the serial clock is set with `SPI_OUT_LOW_TIME`, whereas `SPI_OUT_HIGH_TIME` sets the high phase. Additionally, an `SPI_OUT_BLOCK_TIME` can be set for a minimum time period where no new datagram will be sent after the last SPI output datagram. During this inactive phase SCKDRV_NSDO stays high. All three SPI output parameters are part of the `SPIOUT_CONF` register. They are 4 bit values and represent a number of clock cycles.

PINS WHICH ARE ALSO AFFECTED BY SPI OUTPUT COMMUNICATION

NSCSDRV_SDO low active chip select signal
 SDODRV_SCLK used as output to transfer the datagram to the motor driver
 SDIDRV_NSCLK receives the response from the motor driver. The response is sampled during the data transfer to the motor driver.

MINIMUM AND MAXIMUM TIME PERIOD

The minimum time period for all three parameters is $1/f_{CLK}$. If an SPI output parameter is set to 0 it becomes altered to 2 clock cycles internally. A maximum time period of $15/f_{CLK}$ can be set for all three parameters.

Thus, SPI clock frequency f_{SPI_CLK} covers the following range: $f_{CLK}/30 \leq f_{SPI_CLK} \leq f_{CLK}/2$. The timing of the SPI output communication is illustrated in Figure 11.3.

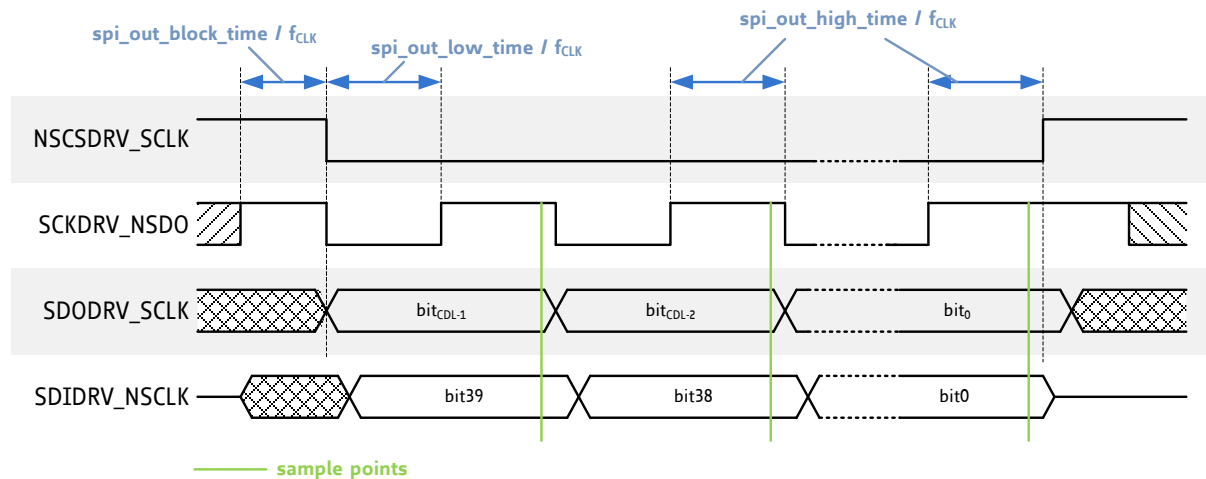

Figure 11.3 SPI output datagram timing (CDL – cover_data_length)

COVER_DONE

At the end of a successful data transmission, the event `COVER_DONE` becomes set. This indicates that the cover register data have been sent to the motor driver and that received responses have been stored in the registers `COVER_DRV_HIGH` and `COVER_DRV_LOW`. `COVER_DRV_HIGH` and `COVER_DRV_LOW` form the cover response register.

The event `COVER_DONE` becomes also set after a successful current datagram transmission.

64 BIT SPI COVER REGISTERS FOR COMMUNICATION BETWEEN μ C AND DRIVER

The 64 bit SPI cover register is separated into two 32 bit registers (*COVER_HIGH* and *COVER_LOW*). Using the cover register, an additional SPI communication channel between microcontroller and motor driver is not needed. The total length of the cover register can be set by *COVER_DATA_LENGTH*. If this parameter is set higher than 64, the cover register data length is still 64 bits at its maximum. The LSB (last significant bit) of the whole cover register is located at *COVER_LOW*(0). Thus, if less than 33 bits are required for SPI communication, only *COVER_LOW* respectively a part of it becomes transmitted (in accordance to *COVER_DATA_LENGTH*). The cover register and the datagram structure are illustrated in Figure 11.4.

Every SPI communication starts with the most significant bit (MSB):

- MSB is *COVER_LOW*(*COVER_DATA_LENGTH* - 1) if *COVER_DATA_LENGTH* < 33.
- MSB is *COVER_HIGH*(*COVER_DATA_LENGTH* - 33) if *COVER_DATA_LENGTH* \geq 33.

Note

Similar to *COVER_LOW* and *COVER_HIGH*, the motor driver response is divided in the registers *COVER_DRV_LOW* and *COVER_DRV_HIGH*. The composition of the response cover register and the positioning of the MSB follow the same structure.

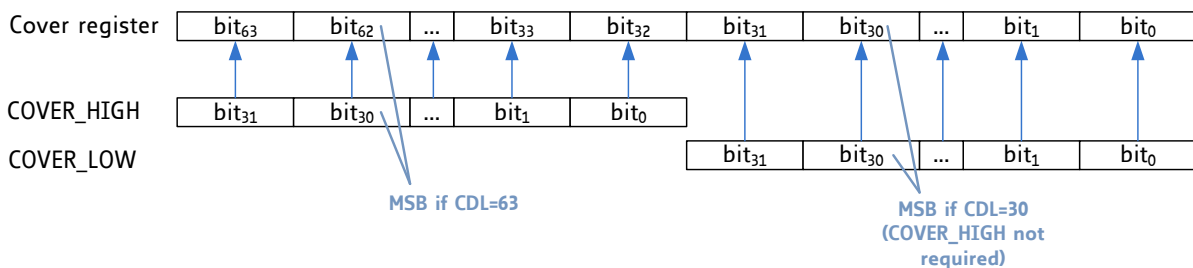

Figure 11.4 Cover data register composition (CDL – cover_data_length)

11.3 Current Datagrams

TMC4361 uses the introduced internal microstep look-up table (MSLUT) for providing current data for the motor driver. With every step initialized by the ramp generator the *MSCNT* value becomes increased or decreased, dependent on the ramp direction. The *MSCNT* register contains the current microstep position of the sine value. Accordingly, the current values *CURRENTA* and *CURRENTB* are altered.

In case the output configuration of the TMC4361 allows for automatic current transfer an updated current value leads to a new datagram transfer. This way, the motor driver always receives the latest data. The length for current datagrams becomes automatically set and the TMC4361 converts new values into the selected datagram format, usually divided in amplitude and polarity bit for TMC motor drivers.

Note that the TMC23x and TMC24x only forward new current data if the upper five bits of one of the two 9 bit current values have changed. This is because TMC23x and TMC24x current data consist of four bit current values and one polarity bit for each coil. Further on, TMC23x and TMC24x current datagrams forward mixed decay bits. These bits can be set with *mixed_decay* which is part of the *SPIOUT_CONF* register. Please refer to the TMC23x/TMC24x datasheets to get more information about setting mixed decay bits correctly.

11.4 TMC Motor Driver

For connecting a TMC stepper motor driver proceed as follows:

The TMC4361 is able to set the cover register length automatically. Therefore, set `COVER_DATA_LENGTH = 0`. Now, the cover register length is set according to the chosen `spi_output_format` setting. `spi_output_format` is the essential parameter for choosing predefined SPI default settings for the particular TMC motor driver.

`COVER_DATA_LENGTH` and `spi_output_format` are part of the `SPIOUT_CONF` register.

TMC STEPPER MOTOR DRIVER AND SETTINGS

TMC motor driver	<code>spi_output_format</code> 3 : 0	Automatic current datagram transfer	Cover register length <code>COVER_DATA_LENGTH=0</code>
TMC23x	b'1000	✓	12
TMC24x	b'1001	✓	12
TMC26x/389	b'1010	✓	20
<i>SPI output for conf. only</i>	b'1011	-	20
TMC21xx	b'1101	✓	40
<i>SPI output for conf. only</i>	b'1100	-	40

11.4.1 Switching from μ Steps to Fullsteps

TMC4361 provides switching to fullstep mode if the absolute velocity value `VACTUAL` exceeds the parameter `FS_VEL`, which is the minimum fullstep velocity. In case, e.g., the Step/Dir output is used, switching from microsteps to fullsteps can lead to a step rate which is 256 times lower than before, assumed that the highest microstep resolution is set. To indicate this microstep resolution change to the microcontroller, the event `FS_ACTIVE` becomes released and thus the microcontroller can adapt the motor driver configuration properly.

For enabling fullstep drive set `fs_en=1`.

TMC260, TMC261, TMC262, TMC2660, TMC389: AUTOMATIC SWITCHOVER TO FULLSTEPS

These advanced motor driver chips offer two interfaces for communication with the motion controller: SPI and Step/Dir. The TMC4361 provides related data for both interfaces concurrently. Decreasing the microstep resolution during a velocity ramp has to be done very carefully. For the ease of use, the TMC4361 provides configuring TMC motor drivers automatically.

SPI OUTPUT USED FOR CONFIGURATION AND CURRENT DATAGRAMS

For this configuration set `spi_output_format = b'1010`.

Now, current values become switched to fullstep values if $|VACTUAL| > FS_VEL$, the internal microstep position of the TMC4361 suits, and `fs_en = 1` has been set before. Consistently, a switchback from fullsteps to microsteps becomes executed if $|VACTUAL| < FS_VEL$.

STEP/DIR INTERFACE USED FOR MOVING THE MOTOR /SPI OUTPUT ONLY USED FOR CONFIGURATION

For this configuration set `spi_output_format = b'1011`, `fs_en = 1`, and `fs_sdout = 0`. Note that `fs_sdout` is only to be used if a motor driver does not provide switching between fullsteps and microsteps automatically.

A continuous polling for SPI datagrams is necessary to get status data from the drivers. Therefore, set `disable_polling = 0`. By setting `POLL_BLOCK_MULT` properly, the time between two consecutive polling datagrams becomes extended to $(POLL_BLOCK_TIME + 1) \cdot SPI_OUT_BLOCK_TIME / f_{CLK}$. A high fullstep frequency requires a short SPI datagram polling time.

Beware the fullstep switch for the TMC26x and TMC389 requires a correct assignment of the read selection bits in the driver registers. If these bits are not set to 00 the transition to fullsteps cannot be executed due to the fact that the TMC4361 does not receive any microstep data from the driver. If fullstep drive is requested and $|VACTUAL| > FS_VEL$, the motor driver is polled to recognize the correct point in time to

switch to full steps. This moment becomes reached when the microstep position of the motor driver equals a fullstep position. The same operation is carried out if fullstep drive has to be switched back to microstep drive.

TMC21xx: MANUAL SWITCHOVER TO FULLSTEPS

These powerful motor driver chips offers two interfaces for communication with the motion controller: SPI and Step/Dir. Therefore, the TMC4361 provides related data for both.

SPI OUTPUT USED FOR CONFIGURATION AND CURRENT DATAGRAMS

For this configuration set *spi_output_format* = b'1101.

Now, current values become switched to fullstep values if $|VACTUAL| > FS_VEL$, the internal microstep position of the TMC4361 suits, and *fs_en* = 1 has been set first. Consistently, a switchback from fullsteps to microsteps becomes executed in case $|VACTUAL| < FS_VEL$.

STEP/DIR INTERFACE USED FOR MOVING THE MOTOR /SPI OUTPUT ONLY USED FOR CONFIGURATION

Note that automatic switching from microsteps to fullsteps and back is not supported for TMC21xx drivers. For switching the microstep resolution manually to fullsteps, check if the motor position fits and set *spi_output_format* = b'1100, *fs_en* = 1, *fs_sdout* = 1, and *disable_polling* = 1 afterwards. A point in time for switching over between microsteps and fullsteps is reached as soon as the microstep position suits to a fullstep position.

Another possibility is to change the microstep resolution using the *STEP_CONF* register.

TMC23x AND TMC24x: AUTOMATIC SWITCHOVER TO FULLSTEPS

Set *spi_output_format* = b'1000 for TMC23x or *spi_output_format* = b'1001 for TMC24x motor drivers. Now, current values become switched to fullstep values if $|VACTUAL| > FS_VEL$, the internal microstep position of the TMC4361 suits, and *fs_en* = 1 has been set before. Consistently, a switchback from fullsteps to microsteps becomes executed in case $|VACTUAL| < FS_VEL$.

CHANGING THE MICROSTEP RESOLUTION

By altering the microstep resolution from 256 (*MSTEP_PER_FS* = b'0000) to a lower value, an internal step results in more than one MSLUT step. If, e.g., the microstep resolution is set to 64 (*MSTEP_PER_FS* = b'0010), the MSCNT becomes in-/decreased by 4 for one internal step. Accordingly, the passage through the MSLUT skips three current values for each internal step to match the new microstep resolution.

11.4.2 How to Use the Current Scale Parameter via SPI Output

Further automatic driver configuration for *spi_output_format* = b'1100 and *spi_output_format* = b'1011 can be used by setting *scale_val_transfer_en* = 1. Using this feature, the current scale parameter *SCALE_PARAM* is sent via SPI output to the motor driver. Pre-settings (made before via cover datagrams) become considered if the particular registers become overwritten with the new scaling value or with the new microstep resolution. The configuration of automatic scaling will be explained in chapter 11.6.

11.4.3 Configuration for the TMC389 3-Phase Stepper Driver

If a TMC389 is connected to the SPI output and a microstep resolution of 256 is set, a three phase stepper output for coil B can be generated. Therefore, set *three_phase_stepper_en* = 1. Now, the *CURRENTB* and *CURRENTB_SPI* values are shifted for 120° (instead of 90° for 2-phase stepper motors).

11.4.4 ChopSync™ Configuration for TMC23x/TMC24x Stepper Drivers

- Set *stdby_clk_pin_assignment* = b'10 to forward the internal clock to the STDBY_CLK output pin.
- Connect the clock signal to the OSC input of the stepper driver. (This input is used as PWM clock input.) Now, the chopSync feature can be used for a fast and smooth drive.
- The clock frequency of the PWM is assigned by setting *CHOPSYNC_DIV*. The internal clock of TMC4361 is divided by this parameter to assign the PWM frequency $f_{OSC} = f_{CLK} / CHOPSYNC_DIV$ with $96 \leq CHOPSYNC_DIV \leq 818$.
- If *stdby_clk_pin_assignment* = b'11 is set the internal clock is forwarded via STDBY_CLK and the chopSync™ feature is not available.

11.4.5 Motor Driver Status Bits and Stall Detection

When a TMC motor driver receives a current datagram (transmitted via the SPI output of the TMC4361) status data is sent back to the TMC4361 controller immediately. These responses from the driver are stored in the *cover response register* which consists of *COVER_DRV_LOW* and if necessary *COVER_DRV_HIGH*. Additionally, motor driver status bits are forwarded to the *STATUS* register. Refer to chapter 17 for detailed information about status bits of TMC motor driver chips.

EVENTS AND INTERRUPTS BASED ON MOTOR DRIVER STATUS BITS

- The *STEP_CONF*(23 : 16) register can be set in a way that selected motor driver status bits release an event if a status bit becomes active.
- For generating an interrupt the motor driver event *EVENTS*(31) can be configured as interrupt source.

STALL DETECTION HANDLING

- TMC motor driver chips always return the stall detection status to the TMC4361 motion controller in response to every received SPI datagram. In most cases, one bit indicates that a motor stall occurred.
- If *stop_on_stall* = 1 is set, an active stall status is handled as a stop event with a hard stop.
- The subsequently released *stop_on_stall* event immediately stops the currently valid velocity ramp.
- For starting a new velocity ramp *setdrv_after_stall* = 1. Now, the *stop_on_stall* event becomes reset.
- The *drv_after_stall* switch has to be set back manually.

TMC26XX, TMC21XX, AND TMC389

Motor driver status bits as response from current datagrams are received automatically if *disable_polling* = 0 during step direction mode. One stall detection status bit is returned to the microcontroller in response to every received SPI datagram.

TMC24X STALLGUARD CHARACTERISTICS

The TMC24x forwards stallGuard values (=LD2&LD1&LD0) instead of one stallGuard status bit. These bits represent an unsigned value between 0 and 7. The lower the value the higher is the mechanical load. By setting *STALL_LOAD_LIMIT* properly, a stall is indicated when $(LD2 \& LD1 \& LD0) \leq STALL_LOAD_LIMIT$ which results in a hard stop if *stop_on_stall* = 1.

Set *stall_flag_instead_of_uv_en* = 1 to replace the undervoltage status bit in the *STATUS* register with the stall status of TMC24x drivers.

A standby datagram is sent to the TMC24x stepper driver if *stdby_on_stall_for_24x* = 1 and a *stop_on_stall* event occurs. This datagram sets current values to 0 which results in a power down of the TMC24x motor driver.

11.5 Other Driver Chips

The TMC4361 provides also configuration data for driver chips of other companies via the cover registers. Please note that the *COVER_DATA_LENGTH* has to be set properly. Furthermore, it is possible to support automatic current data transfer. The following format settings can be chosen:

Output formats	<i>spi_output_format</i>	Automatic current datagram transfer	Automatic cover register length (if <i>COVER_DATA_LENGTH=0</i>)
SPI output off	b'0000	-	1
Signed current data	b'0101	✓	1
Unsigned scaling factor	b'0100	-	1
DAC scaling factor	b'0110	-	1
DAC absolute values	b'0010 / b'0011	✓	1
DAC adapted values	b'0001	✓	1

COMMENTS ON THE TABLE

- *spi_output_format* = b'0000 switches off the SPI output.
- *spi_output_format* = b'0101 leads to a transfer of both signed current values one after the other in an 18 bit datagram.
- With *spi_output_format* = b'0100, the 8 bit scaling factor is transmitted if it has been altered. This scaling data could also be transmitted for a DAC by setting *spi_output_format* = b'0110, assumed that the SPI capabilities of the DAC fit.
- *spi_output_format* = b'0010 converts the current values for the SPI capable DAC into absolute values. The current phases of both coils are forwarded via the STPOUT (coilA) and DIROUT (coilB) outputs. A phase bit polarity of 0 indicates a positive value.
- *spi_output_format* = b'0011 converts the current values for the SPI capable DAC into absolute values. The current phases of both coils are forwarded via the STPOUT (coilA) and DIROUT (coilB) outputs. A phase bit polarity of 0 indicates a negative value.
- With *spi_output_format* = b'0001 the currents are mapped to an unsigned value. Therefore, a value of 256 is added to the signed current values. Thus, the current value 0 results in a 9 bit value of b'10000000 whereas the minimum value of -256 is exported as b'00000000 and the maximum value of 255 as b'11111111.
- Additionally *fs_sdout* can be set to 1 in case switching from microsteps to fullsteps and back is desired.

DAC VALUE OFFSET AND LENGTH OF DATAGRAM

- An offset can be added for the values of both coils by setting *DAC_OFFSET* to compensate for a shifted base line, except in case *spi_output_format* = b'0001.
- Usually, SPI transfers require an address or a command in front of a transmitted value. The length of the prefixed command or address can be assigned by setting *DAC_CMD_LENGTH*.
- The bit stream which constitutes the command or address can be stored in the *DAC_ADDR* register with 16 bits for both coils separately. Due to the transfer of only one value per datagram, two datagrams are sent in a row: first the coilA command and value are sent and afterwards the coilB command and value. If the cover register length comprises more bits than the combination of command and value, zeros are added at the end. This is because the cover register length determines the length of the datagram for DAC values. Note that the command bits consist of the least significant bits of *DAC_ADDR* if the command length is less than 16 bit.

CHANGING SPI OUTPUT TRANSFER CONDITIONS

Sometimes, other SPI output transfer conditions are required. Therefore, further configuration is possible:

- By setting *sck_low_before_csn* = 1, SCKDRV_NSDO is tied low before NSCSDRV_SDO. (Per default setting, SCKDRV_NSDO is tied high.)
- Further on, TMC drivers sample the master data with the rising edge of the master clock. Thus, TMC4361 shifts the output data at SDODRV_SCLK with the falling edge of SCKDRV_NSDO. In case the data is sampled with the falling edge of the master clock at the driver's side, the data at SDODRV_SCLK has to be shifted with the rising edge of SCKDRV_NSDO. Therefore, *setnew_out_bit_at_rise* = 1

11.6 Current Scaling & Ramp Status

Various possibilities have been implemented to adapt the actual current values of the internal microstep look-up table MSLUT to the current ramp status.

Multiplication

Actual current values are multiplied with the *MULT_SCALE* parameter, which is deduced from the *SCALE_PARAM* register:

$$MULT_SCALE = (\text{actual_SCALE_VAL} + 1) / 256$$

with $0 < MULT_SCALE \leq 1$ and $\text{actual} = \{\text{HOLD, BOOST, DRV1, DRV2}\}$.

The actual *MULT_SCALE* parameter is provided via the *SCALE_PARAM* register value which is calculated by the following expression:

$$SCALE_PARAM = MULT_SCALE \cdot 256 - 1.$$

Current value calculation for SPI output:

$$CURRENTA_SPI = CURRENTA \cdot MULT_SCALE \quad CURRENTB_SPI = CURRENTB \cdot MULT_SCALE$$

Eight bit scale parameters

The actual values *CURRENTA* and *CURRENTB* can be scaled down with bit scale parameters. The names of these parameters end with *_SCALE_VAL*. They are part of the *SCALE_VALUES* register.

Scale parameters are available for boost current (*BOOST_SCALE_VAL*), hold current (*HOLD_SCALE_VAL*), and drive current (*DRV1_SCALE_VAL* and *DRV2_SCALE_VAL*). These parameters can be assigned independently. Several different scaling types are provided:

For scaling the current values during standstill two settings are available:

STANDBY SCALING

- Set *HOLD_CURRENT_SCALE_EN* = 1.
- The *STDBY_DELAY* timer is started as soon as *VACTUAL* reaches 0.
- In case the standby timer expires and *VACTUAL* is still 0, standby mode is valid and currents are scaled down using *HOLD_SCALE_VAL* now.
- In case *STDBY_DELAY* is set to 0 standby mode is valid immediately after reaching *VACTUAL*=0.

Note: if *stdby_clk_pin_assignment*(1) = 0, the *STDBY_CLK* output pin forwards the standby signal with active polarity which is equal to the setting *stdby_clk_pin_assignment*(0).

SCALING FOR FREEWHEELING

- For freewheeling set *freewheeling_en* = 1.
- As soon as standby mode is reached, the *FREEWHEEL_DELAY* timer is started. It expires while standby mode remains active.
- When *FREEWHEEL_DELAY* is elapsed, *freewheeling mode* becomes enabled and thus all current values are altered to 0.
- In case *FREEWHEEL_DELAY* is set to 0, *freewheeling mode* becomes valid immediately after reaching standby mode.

It is also possible to manipulate standard current values during the ramp:

BOOST SCALING AT RAMP START

- *Setboost_current_after_start_en* = 1 for scaling current values with *BOOST_SCALE_VAL*.
- *Boost scaling at ramp start* begins with the onset of a velocity ramp, assumed that *VACTUAL* has been set to 0 before.
- At the ramp start the *BOOST_TIME* (value represents a number of clock cycles) becomes initialized. When this timer expires, boost scaling after start is finished.

BOOST SCALING ON ACCELERATION RAMPS

- If *RAMP_STATE* = b'01 and *boost_current_on_acc_en* = 1 are set, actual current values are scaled with *BOOST_SCALE_VAL*.
- *RAMP_STATE* = b'01 is always valid when the absolute velocity value increases.

BOOST SCALING ON DECELERATION RAMPS

- If *RAMP_STATE* = b'10 and *boost_current_on_dec_en* = 1 are set, the actual current values are scaled with *BOOST_SCALE_VAL*.
- *RAMP_STATE* = b'10 is always valid when the absolute velocity value decreases.

DRIVE SCALING

- If *drive_current_scale_en* is set to 1, current values are scaled with *DRV1_SCALE_VAL*, assumed that no other scaling mode is active at that moment.
- In case *sec_drive_current_scale_en* = 1 is chosen additionally, *DRV1_SCALE_VAL* is only used if the condition $VACTUAL \leq VDRV_SCALE_LIMIT$ is met.
- If *sec_drive_current_scale_en* = 1, *drive_current_scale_en* = 1, and $VACTUAL > VDRV_SCALE_LIMIT$ are valid, current values are scaled with *DRV2_SCALE_VAL*, assumed that no other scaling mode is active.

Setup of scaling values for Step/Dir operation with TMC21xx, TMX26xx, or TMC389

Scaling values are transmitted directly to the driver in case *Step/Dir output mode* and *scale_val_transfer_en* = 1 is valid. Please note that the maximum scale value is 31 due to the fact that scale values are stored as 5 bit numbers. Thus, only the last 5 bits of the eight bit scaling registers are transferred in *Step/Dir output mode*. Furthermore, *MULT_SCALE* is calculated at the driver devices using the following equation: $MULT_SCALE = (actual_SCALE_VAL + 1) / 32$

Controlling the transition process from one scale mode to another

The transition from one scale value to the next can be configured and has not to be abruptly. Three parameters are available for controlling the progression:

UP_SCALE_DELAY

Set the period of clock cycles during which a current scale value is increased by one step towards the higher target scale value with *UP_SCALE_DELAY*.

HOLD_SCALE_DELAY

Set the period of clock cycles during which a current scale value is decreased by one step towards the lower target scale value *HOLD_SCALE_VAL* with *HOLD_SCALE_DELAY*.

DRV_SCALE_DELAY

DRV_SCALE_DELAY is the time period that is required to decrease the actual scale value towards a scale value which is smaller than the current one.

Setting any of these parameters to 0 will result in an immediate transition to the next scale value for the introduced conditions.

The following two examples illustrate how scaling modes are to be used.

EXAMPLE 1

Standby scaling, freewheeling, boost scaling at start, boost scaling on deceleration ramps, and drive scaling I are enabled. Current scale parameters (SCALE_PARAM) are shown as well as their related scale timers in clock cycles. The timers are used to finish boost scaling after start and to start standby scaling and freewheeling. The three depicted delay values are calculated as follow:

$$t_{DN_SCALE} = (BOOST_SCALE_VAL - DRV1_SCALE_VAL) \cdot DRV_SCALE_DELAY$$

$$t_{UP_SCALE} = (BOOST_SCALE_VAL - DRV1_SCALE_VAL) \cdot UP_SCALE_DELAY$$

$$t_{HOLD_SCALE} = (DRV1_SCALE_VAL - HOLD_SCALE_VAL) \cdot HOLD_SCALE_DELAY$$

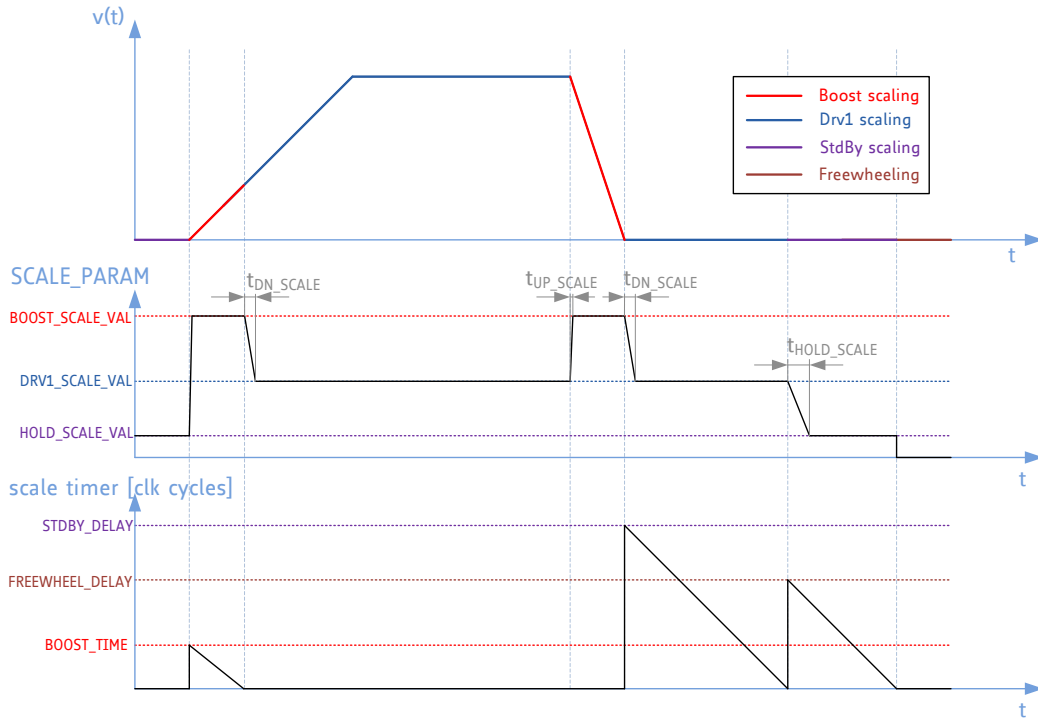

Figure 11.5 Scaling: example 1

EXAMPLE 2

Boost scaling on acceleration ramps and both drive scaling modes are enabled. As long as $VACTUAL < VDRV_SCALE_LIMIT$, drive scaling I is active. Both drive scaling modes are used for the deceleration ramp due to $boost_current_on_dec = 0$. When $VACTUAL$ reaches 0, the $RAMP_STATUS$ switches to acceleration ramp and boost scaling becomes enabled a second time.

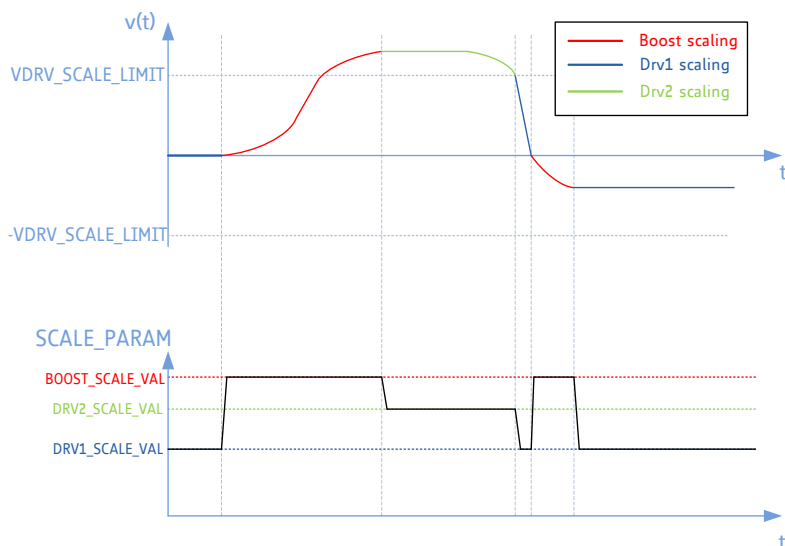

Figure 11.6 Scaling: example 2

12 NFREEZE: Emergency-Stop

In case of dysfunctions at board level, some applications require an additional strategy to end current operations without any delay. Therefore, the TMC4361 provides the low active safety pin NFREEZE.

PINS AND REGISTERS: FREEZE FUNCTIONALITY

Pin names	Type		Remarks
NFREEZE	Input		External enable pin; low active
Register name	Register address		Remarks
DFREEZE	0x4E (23 : 0)	RW	Deceleration value in the case of an active FREEZE event
IFREEZE	0x4E (31 : 24)	RW	Current scaling value in the case of an active FREEZE event

NFREEZE is low active. An active NFREEZE input transition from high to low level stops the current ramp immediately in a user configured way. At the moment when NFREEZE switches to low, an event (*FREEZED*) is triggered at *EVENTS(10)*. *FREEZED* remains active until the reset of the TMC4361.

Due to an input filter of three consecutive sample points it is necessary to tie NFREEZE low for at least three clock cycles.

12.1 Freeze Function Configuration

Two parameters (*DFREEZE* and *IFREEZE*) are necessary for using the TMC4361 freeze function. They are integrated in the freeze register which can be written only once after an active reset, assumed that there has been no ramp started before. Thus, the freeze parameters should be set directly in the beginning of operation. Note that the chosen values cannot be altered until the next active reset.

These restrictions are necessary to protect the TMC4361 freeze configuration from incorrect SPI data sent from the microcontroller in case of error.

Note

The polarity of the NFREEZE input cannot be assigned.

The freeze register can always be read out.

During freeze state ramp register values can be read out.

CONFIGURING *DFREEZE* FOR AN AUTOMATIC RAMP STOP

- Set *DFREEZE* = 0 for a hard stop.
- Set *DFREEZE* ≠ 0 for a linear deceleration ramp.

Due to the independence of *DFREEZE* from internal register values like *direct_acc_val_en* or the given clock frequency *CLK_FREQ* (which can be altered by erroneous SPI signals) the deceleration value *DFREEZE* is always given as velocity value change per clock cycle. Therefore, the *DFREEZE* value is calculated as follows:

$$d_freeze[pps^2] = DFREEZE / 2^{37} \cdot f_{clk}^2$$

This leads to the same behavior of the motor as a *direct_acc_val_en* = 1 setting during normal operation.

CONFIGURING THE *IFREEZE* CURRENT SCALING VALUE

IFREEZE is a current scaling value which becomes valid in case *NFREEZE* has been tied to low and the related event (*FREEZED*) has been released. In case *IFREEZE* is set to 0, the last scaling value before the emergency event is assigned permanently. The scale value *IFREEZE* then manipulates the current value in the same way as explained in chapter 11.6.

13 Controlled PWM Output

The TMC4361 allows for using PWM output values instead of Step/Dir outputs.

PINS AND REGISTERS: PWM OUTPUT

Pin names	Type	Remarks
STPOUT_PWMA	Output	PWM output for coilA
DIROUT_PWMB	Output	PWM output for coilB
Register name	Register address	Remarks
GENERAL_CONF	0x00	RW Bit21: <i>pwm_out_en</i>
PWM_AMPL	0x06	RW Second assignment to <i>SCALE_VALUES(15 : 0)</i> : PWM amplitude at <i>VACTUAL</i> = 0
PWM_VMAX	0x17	RW Second assignment to <i>VDRV_SCALE_LIMIT</i> :velocity at which the PWM scale parameter reaches 1 (max)
PWM_FREQ	0x1F	RW # of clock cycles which forms one PWM period

13.1 PWM Output Generation

For generating a PWM output, set *pwm_out_en* = 1. Now, the Step/Dir output is disabled and PWM signals are forwarded via STPOUT_PWMA and DIROUT_PWMB. The PWM frequency is calculated as follows:
 $f_{\text{PWM}} = f_{\text{CLK}} / \text{PWM_FREQ}$.

The duty cycle for both coils is indicated by a high output level. For higher velocity a higher duty cycle is required. Therefore, the TMC4361 alters a PWM scale parameter (*PWM_SCALE*) as a function of the current velocity:

- If *VACTUAL* = 0, $\text{PWM_SCALE} = (\text{PWM_AMPL} + 1) / 2^{17}$.
- With increasing velocity, the scale parameter raises linear to a maximum of $\text{PWM_SCALE} = 0.5$ at $\text{VACTUAL} = \text{PWM_VMAX}$.
- The minimum duty cycle is calculated with $\text{DUTY_MIN} = (0.5 - \text{PWM_SCALE})$.
- The maximum duty cycle is calculated with $\text{DUTY_MAX} = (0.5 + \text{PWM_SCALE})$.

The current duty cycle for both coils is calculated using the microstep loop-up table MSLUT. In this case the MSLUT describes a voltage (co-)sine curve whose amplitudes become transferred to the PWM phases. The values are scaled related to minimum and maximum duty cycles.

In the following illustration, the calculation of minimum/maximum PWM duty cycles with $\text{PWM_AMPL} = 32767$ is pointed out at the left side. Resulting duty cycles for different positions in the sine voltage curve are depicted at the right side. Calculated delays of minimum/maximum duty cycles are also shown.

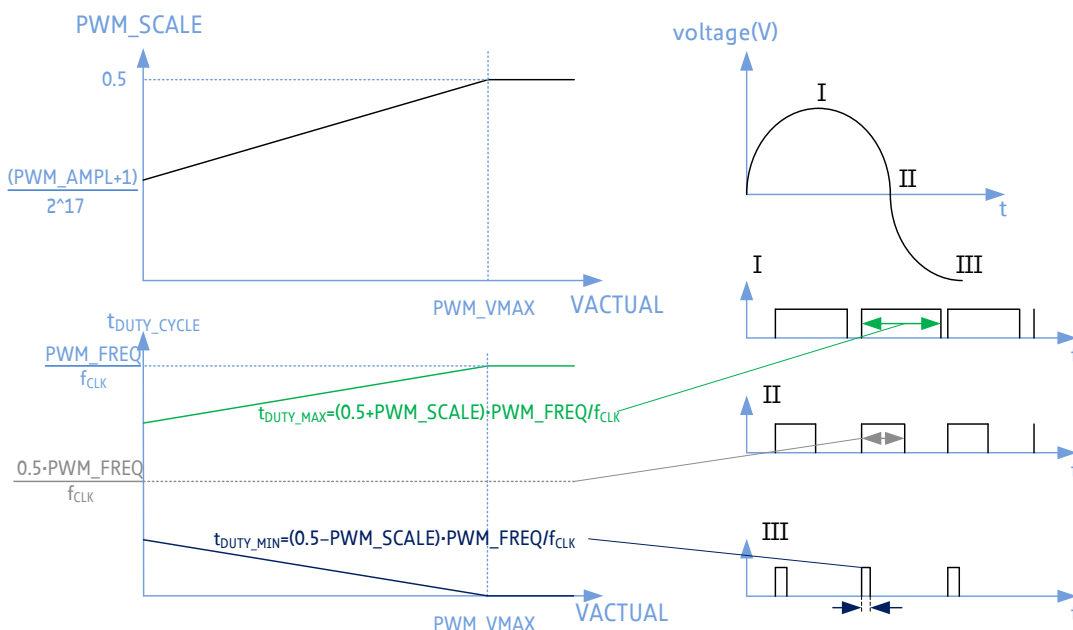

Figure 13.1 Calculation of PWM duty cycles

14 Decoder Unit& Closed Loop

The TMC4361 is equipped with an encoder input interface for incremental ABN encoders or absolute encoders like SSI or SPI encoders. Motor feedback can be analyzed and even closed loop behavior can be reached by setting the registers appropriately.

PINS AND REGISTERS: DECODER UNIT

Pin names	Type		Remarks
A_SCLK	Input or Output		A signal of ABN encoder or serial clock output for SSI or SPI encoders
ANEG_NSCLK	Input or Output		Negated A signal of ABN encoder or negated Serial Clock output for SSI encoder or low active chip select signal for SPI encoders
B_SDI	Input		B signal of ABN encoder or serial data input of SSI or SPI encoders
BNEG_NSDI	Input or Output		Negated B signal of ABN encoder or negated Serial Data input of SSI encoder or serial data output of SPI encoder
N	Input		N signal of ABN encoder
NNEG	Input		Negated N signal of ABN encoder
Register name	Register address		Remarks
GENERAL_CONF	0x00	RW	Bit11 : 10 <i>serial_enc_in_mode</i> Bit12 <i>diff_enc_in_disable</i>
INPUT_FILT_CONF	0x03	RW	Input filter configuration (SR_ENC_IN, FILT_L_ENC_IN)
CURRENT_CONF	0x05	RW	Bit7 <i>closed_loop_scale_en</i>
SCALE_VALUES	0x06	RW	Current scaling values and limits for closed loop operation
ENC_IN_CONF	0x07	RW	Configuration register for encoder input interface and signals
ENC_IN_DATA	0x08	RW	Data resolutions for serial encoder inputs
STEP_CONF	0x0A	RW	Motor configurations
Closed loop Register	0x18...A, 0x1C 0x60...61	RW W	Further closed loop configuration parameter
ENC_POS	0x50	RW	Current absolute encoder position in microsteps
ENC_LATCH	0x51	R	Latched absolute encoder position
ENC_POS_DEV	0x52	R	Deviation between <i>XACTUAL</i> and <i>ENC_POS</i>
ENC_CONST	0x54	R	Internally calculated encoder constant
Encoder Register Set	0x53...59 0x63...64	W	Encoder configuration parameter

14.1 General Encoder Interface

The encoder interface consists of six pins (A_SCLK, ANEG_NSCLK, B_SDI, BNEG_NSDI, N, NNEG). For configurations set `serial_enc_in_mode.N` and NNEG are only required for incremental encoders. All encoder input signals become filtered using the digital filter introduced in chapter 6. Thus, `SR_ENC_IN` and `FILT_L_ENC_IN` have to be set properly.

CHOOSING THE SERIAL ENCODER_IN MODE

`serial_enc_in_mode= b'00`: ABN incremental encoder setting. All six interface pins are inputs. Signals are interpreted as ABN signals of an incremental encoder.

`serial_enc_in_mode= b'01`: Absolute SSI encoder setting. A_SCLK and ANEG_NSCLK are outputs which forward the master clock signals to the motor encoder interface. Only B_SDI and BNEG_NSDI are required as inputs in order to receive data from the encoder.

`serial_enc_in_mode= b'10`: Setting reserved for absolute BiSS encoder.

`serial_enc_in_mode= b'11`: Absolute SPI encoder setting. A_SCLK is the serial clock output, ANEG_NSCLK is the low active chip select output, B_SDI functions as serial data input from the SPI encoder, and BNEG_NSDI is the serial data output. `diff_enc_in_disable` is set automatically to 1.

HOW TO ENABLE OR DISABLE DIFFERENTIAL ENCODER SIGNALS

`diff_enc_in_disable=0` Differential encoder interface inputs are enabled. Differential inputs are treated as digital differential inputs. For advertising a valid level the levels have to be inversed.

`diff_enc_in_disable=1` Differential encoder interface inputs are disabled. For SPI encoders this is done automatically. Signals are handled as single signals and every negated pin becomes ignored.

14.2 Incremental ABN Encoder

The incremental ABN encoder increments or decrements the internal `ENC_POS` counter. This is based on A and B signal level transitions.

ABN ENCODER CONFIGURATION

1. Choose the number of microsteps per AB transition:
 - Set the fullstep resolution of the motor with `FS_PER_REV` first.
 - Now, choose the microstep resolution `MSTEP_PER_FS` for the drive.
 - Then, set the encoder resolution with `ENC_IN_RES`.
2. Choose the direction of the encoder with `invert_enc_in`. Set 1 for inverting if desired.
3. Verify the encoder constant. `ENC_CONST` is calculated automatically, if the settings for `FS_PER_REV`, `MSTEP_PER_FS`, and `ENC_IN_RES` fit properly. `ENC_CONST` gives the number of microsteps which are added or subtracted from `ENC_POS` (dependent on the direction) with every AB transition. It is calculated with

$$ENC_CONST = MSTEP_PER_FS \cdot FS_PER_REV / ENC_IN_RES$$

`ENC_CONST` can be read out. It consists of 16 digits and 16 decimal places. If there are not enough decimal places due to given parameters, the TMC4361 tries to match them to a multiply of 10000. This way, a perfect match can be achieved in case the binary representation fails. If also the decimal representation does not fit completely, the type of the decimal places of `ENC_CONST` can be chosen by hand with `ENC_IN_CONF(0)`. Set `ENC_IN_CONF(0)` to 0 for the binary representation or set it to 1 for the decimal one.

14.2.1 N Signal resp. Z Channel

The N signal (or Z channel) is either used to clear the position counter or to take a snapshot. The following configuration parameters are provided:

<i>pol_n</i>	Set the active polarity with this parameter.
<i>n_chan_sensitivity</i>	Set <i>n_chan_sensitivity</i> for special requests: <ul style="list-style-type: none"> 00 N event is active if the voltage level at N fits <i>pol_n</i> 01 N event is triggered at the positive edge when N becomes active. 10 N event is triggered at the negative edge when N becomes active. 11 N event is triggered at both edges when N becomes active and/or inactive.
<i>pol_a_for_n</i> , <i>pol_b_for_n</i>	Some encoders require a validation of the N signal at a certain configuration of A and B polarities. This can be controlled by <i>pol_a_for_n</i> and <i>pol_b_for_n</i> switches in the <i>ENC_IN_CONF</i> register. When, e.g., <i>pol_a_for_n</i> and <i>pol_b_for_n</i> are set, an active N event is only accepted if the polarity of the A channel and the B channel is high.
<i>ignore_ab</i>	Set <i>ignore_ab</i> = 1 to disable the validation of the N signal via A and B channel polarity. Then, these channel polarities have no influence on the N signal event.
<i>latch_enc_on_n</i>	Set <i>latch_enc_on_n</i> = 1 to monitor the encoder position <i>ENC_POS</i> on an active N event. Still, additional switches are required to monitor the encoder position. Refer to <i>clr_latch_cont_on_n</i> and <i>clr_latch_once_on_n</i> .
<i>clear_on_n</i>	To clear the encoder position <i>ENC_POS</i> on the next N event set <i>clear_on_n</i> = 1. Again, additional switches are required to clear <i>ENC_POS</i> . Refer to <i>clr_latch_cont_on_n</i> and <i>clr_latch_once_on_n</i> .
<i>clr_latch_cont_on_n</i>	Set <i>clr_latch_cont_on_n</i> = 1 to clear or monitor continuously on an active N event.
<i>clr_latch_once_on_n</i>	Set <i>clr_latch_once_on_n</i> = 1 to clear or monitor on an active N event only once. After latching and/or clearing the encoder position <i>clr_latch_once_on_n</i> is disabled automatically. This is necessary if only the next of periodic N events (e.g. once for every revolution) should be considered.
<i>latch_x_on_n</i>	Set <i>latch_x_on_n</i> = 1 to monitor <i>XACTUAL</i> on <i>X_LATCH</i> . The tasks of encoder latching are adopted for <i>X_LATCH</i> . Please note that <i>latch_enc_on_n</i> has to be set just as <i>clr_latch_cont_on_n</i> or <i>clr_latch_once_on_n</i> .

For clearing the encoder position *ENC_POS* with the next active N event set *clear_on_n* = 1 and *clr_latch_once_on_n* = 1 or *clr_latch_cont_on_n* = 1.

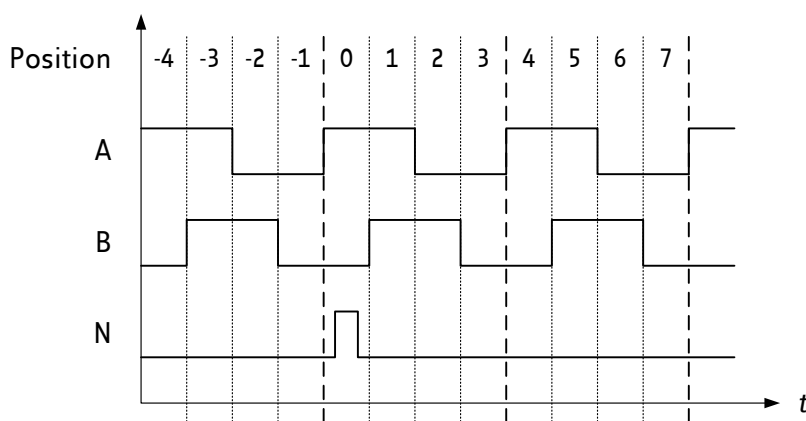

Figure 14.1 Outline of ABN signals of an incremental encoder

14.3 Absolute Encoder

In this chapter, common settings for SSI or SPI encoders are explained. Specific information about respective serial encoders is given in subsections.

Serial encoders provide absolute encoder data instead of step transition, whose information is delivered from incremental encoders. Due to the serial data input the TMC4361 provides an external clock for the encoder.

The TMC4361 provides different possibilities for the serial data stream. Single turn data or multi turn data can be used. In case single turn data is transmitted the TMC4361 is able to calculate the number of revolutions permanently.

CHOOSING ENCODER DATA AND DATA TYPE FOR TRANSMISSION

<i>multi_turn_in_en</i>	In case <i>multi_turn_en</i> = 1 the serial encoder transmits the actual motor angle as well as data about the number of revolutions. If set to 0, the serial encoder transmits only the actual motor angle (single turn).
<i>multi_turn_in_signed</i>	In case it is desired to interpret the data about the number of revolutions as a signed value, set <i>multi_turn_in_signed</i> = 1. Otherwise it is assigned as unsigned value.
<i>calc_multi_turn_behav</i>	For calculating the number of revolutions out of single turn data set <i>calc_multi_turn_behav</i> = 1 and <i>multi_turn_in_en</i> = 0. In case two sequenced values differ in more than half a revolution, switch <i>calc_multi_turn_behav</i> off because the calculation will provide false data.

The encoder constant *ENC_CONST* is calculated the same way as for incremental ABN encoders. But in contrast to ABN encoders it always represents a binary value. The value is multiplied with the transferred angle value for calculating the microstep position, which is stored in *ENC_POS* afterwards. *ENC_CONST* is generated automatically, if the settings for *FS_PER_REV*, *MSTEP_PER_FS*, and *ENC_IN_RES* fit properly. It is calculated as follows:

$$ENC_CONST = MSTEP_PER_FS \cdot FS_PER_REV / ENC_IN_RES$$

ENC_CONST could be read out. It consists of 16 digits and 16 decimal places in case a serial encoder is selected.

SETTINGS RELATED TO DATA TRANSMISSION

<i>SINGLE_TURN_RES</i>	Set the number of bits for single turn data here. <i>SINGLE_TURN_RES</i> defines the most significant bit (MSB). The number of angle data bits within one revolution is <i>SINGLE_TURN_RES</i> + 1.
<i>MULTI_TURN_RES</i>	Set the number of bits for multi turn data here. <i>MULTI_TURN_RES</i> defines the most significant bit (MSB). The number of data bits for revolution count is <i>MULTI_TURN_RES</i> + 1. Information about the number of rotations is always expected to be sent before actual motor angle data!
<i>STATUS_BIT_CNT</i>	Set the number of status bits which are transmitted from the encoder here. Status bits consist of three bits at maximum.
<i>left_aligned_data</i>	This parameter is used to choose a sequential arrangement for status and serial input data. Set <i>left_aligned_data</i> =0 for receiving the flags first and then the input data. Set <i>left_aligned_data</i> =1 for serial input data first and flags afterwards.
<i>serial_enc_variation_limit</i>	If erroneous data transmission from the encoder is expected, set <i>serial_enc_variation_limit</i> = 1. Now, the differences of sequenced encoder values become calculated. If a difference between two values exceeds one eighth of <i>ENC_IN_RES</i> , the last encoder data is skipped. The <i>MULTI_CYCLE_FAIL_F</i> status flag becomes set and the <i>SER_ENC_DATA_FAIL</i> event becomes triggered. As a result, <i>calc_multi_turn_behav</i> can be used with no doubt due to the fact that the values never differ in more than half a revolution.

Generating a clock which requires more than the given serial bit range

If more than three status bits or additional fill bits are sent, clock errors can occur because the number of transferred clock bits is calculated by

$$\#serial_clock_cycles = (SINGLE_TURN_RES + 1) + (MULTI_TURN_RES + 1) + STATUS_BIT_CNT.$$

In order to prevent clock failures *MULTI_TURN_RES* can be set to a higher value than required, even if no multi turn data is provided.

Note that this setting may result in erroneous multi turn data. This can be corrected by setting *multi_turn_in_en* = 0 for skipping multi turn data automatically. Further, *calc_multi_turn_behav* can be set to 1 for compensating unavailable multi turn data.

14.3.1 SSI Encoder Serial Clock

After indicating data transfer by switching the clock output to low level, the transfer starts with the next rising edge of the serial clock output. The periods for low level and for high level have to be set separately using *SER_CLK_IN_LOW* and *SER_CLK_IN_HIGH* which are given in internal clock cycles.

START/END DELAY TIME

Sample points of serial data are set at the falling edges of the serial clock. Some encoders need more clock cycles than the low clock phase to prepare data for transfer. Further, due to long wires data transfer can take more time. Considering these points, the delay time for compensation *SSI_IN_CLK_DELAY* can be specified in clock cycles and the parameter delays the sampling start. Due to the delay, more clock cycles of the serial clock can be required which is automatically taken into account. Per default, *SSI_IN_CLK_DELAY* is set to 0 and therefore *SER_CLK_IN_HIGH* is valid instead.

DELAY TIME BETWEEN SEQUENCED DATA REQUESTS

After a data request the next one is sent past *SSI_IN_PTIME* clock cycles. Choose the value of this parameter higher than 21 μ s.

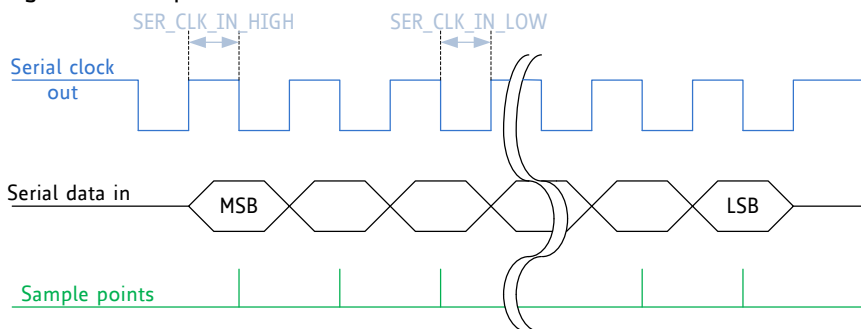

Figure 14.2 SSI signals with *SSI_IN_CLK_DELAY* = *SER_CLK_IN_HIGH* when *SSI_IN_CLK_DELAY* = 0

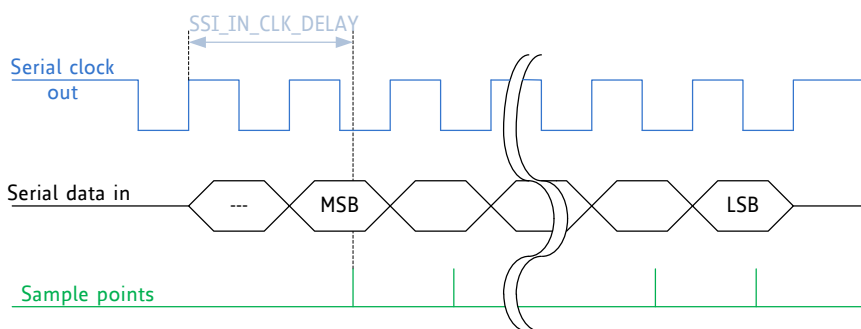

Figure 14.3 SSI signals with *SSI_IN_CLK_DELAY* for compensating processing time and long wires

REPEATED DATA TRANSFER (MULTI CYCLE REQUEST)

If a repeated data transfer is requested, set *ssi_multi_cycle_data* = 1. Further, adjust *SSI_IN_WTIME*. This parameter configures the waiting time between two equal data requests (the same value becomes transferred more than once). Set the *SSI_IN_WTIME* smaller than 19 μ s.

If two data values that normally must be equal (due to the multi cycle data request) are not equal, the *MULTI_CYCLE_FAIL_F* flag and the *SER_ENC_DATA_FAIL* event are generated, assumed that *serial_enc_variation_limit* is 0.

GRAY ENCODED DATA STREAMS

Serial data streams can be gray encoded. Set `ssi_gray_code_en` to 1 in order to decode them properly.

14.3.2 SPI Encoder

The number of bits per transfer is calculated automatically. Therefore, set `SINGLE_TURN_RES`, `MULTI_TURN_RES`, and `STATUS_BIT_CNT` properly.

COMMUNICATION PROCESS

Typically, the answer of SPI data transfer requests is sent with the next transmission. When the TMC4361 receives the answer from the encoder, it calculates `ENC_POS` immediately. The encoder slave does not send any data without receiving a request first. Therefore, the TMC4361 always sends the `ADDR_TO_ENC` value to request encoder data from the SPI encoder slave device. The LSB of the serial data output is `ADDR_TO_ENC(0)`. The clock is generated by the values given from `SER_CLK_IN_HIGH` and `SER_CLK_IN_LOW`.

The MSB results from the number of bits that are required for the whole transmission:

$$\text{MSB}_{\text{SPI_ENC}} = (\text{SINGLE_TURN_RES} + 1) + (\text{MULTI_TURN_RES} + 1) + \text{STATUS_BIT_CNT} - 1.$$

With the `SSI_IN_P_TIME` register a time period after the last request can be set. During this period no further data transfer becomes initiated.

STORING ENCODER VALUES

Received encoder data is stored in `ADDR_FROM_ENC`. Thus, encoder values can be verified and compared to microcontroller data later on.

SPI Data Transfer within the Transmission

For applications providing a response to SPI data transfer requests within the transmission, suggestions explained in **Generating a clock which requires more than the given serial bit range** (see chapter 14.3) are valid. Therefore, `MULTI_TURN_RES` has to be expanded for reaching the required data length. Further, the first bits of `B_SDI` must be zero if the multi turn data of the data transfer should also be evaluated. This way, proper evaluation of incoming data is guaranteed.

FURTHER SETTINGS RELATED TO ENCODER TYPES

Per default, SPI encoder data transfer is managed just as the communication between microcontroller and TMC4361. For supporting all SPI encoder types, the TMC4361 provides further settings:

<code>spi_low_before_cs</code>	Set this parameter to 1 if the SPI clock has to be low before chip select switches to low level.
<code>spi_data_on_cs</code>	Set this parameter to 1 for sending the MSB of the data output with the transition of the chip select signal to active level. Thus, <code>BNEG_NSDI</code> provides output data immediately at <code>ANEG_NSCLK</code> transition. If set to 0, the data is sent after the first transition of the clock signal. In both cases data from <code>B_SDI</code> becomes sampled at the next clock transition.

To achieve a correct synchronization, it is possible to choose `SSI_IN_CLK_DELAY` > 0. Thus, a delay time for `SER_CLK_IN_HIGH` and `SER_CLK_IN_LOW` can be defined. This delay setting can be considered in case the clock scheme provided by `SER_CLK_IN_HIGH` and `SER_CLK_IN_LOW` does not fit perfectly to the delay between the first and the last transition of signals of the chip select (`ANEG_NSCLK`) and the clock output (`A_SCLK`). `SSI_IN_CLK_DELAY` is shown in Figure 14.4 as red lined distances.

The following diagrams are examples for different *spi_data_on_cs* and *spi_low_before_cs* settings.

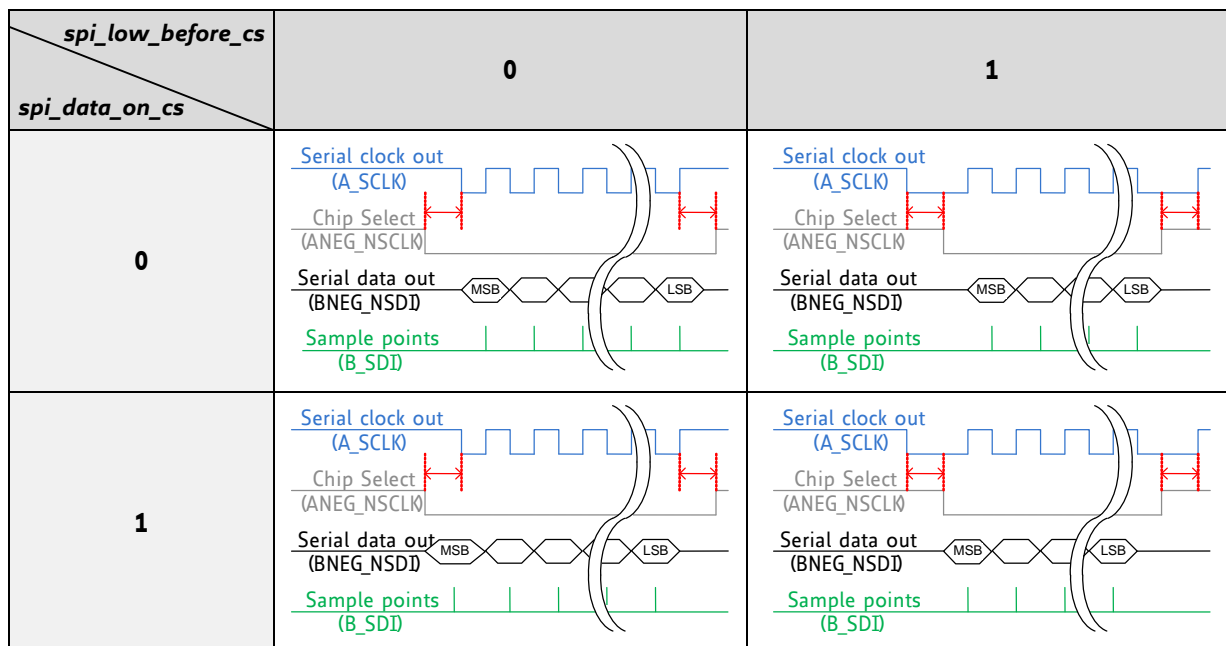

Figure 14.4 Supported SPI encoder data transfer modes

SPI ENCODER CONFIGURATION VIA TMC4361

The SPI encoder can be configured by the TMC4361. Thus, a connection between microcontroller and encoder is not necessary any more. A configuration request is sent using the settings of the *SERIAL_ADDR_BITS* and *SERIAL_DATA_BITS* which define the transferring bit numbers. Due to repeated encoder data requests a call for configuration has to be done in the meantime. Therefore, *DATA_TO_ENC* can be used for configuration while the continuous requests for encoder data are interrupted during configuration process.

PROCEED AS FOLLOWS

1. Write access to *DATA_TO_ENC* to notify a configuration request.
2. Write the requested address to *ADDR_TO_ENC*.
3. Write the requested data to *DATA_TO_ENC*.
4. Now, three datagrams are sent to the SPI encoder:
 - The address data from *ADDR_TO_ENC* (data from encoder is not stored).
 - The register data from *DATA_TO_ENC* (the received data from the encoder is stored in *ADDR_FROM_ENC*).
 - A no-operation datagram (*NOP*) to get the answer from the encoder (which becomes stored in *DATA_FROM_ENC*).
5. Now, returned and stored data from the encoder can be read out and checked by the microcontroller. Read out *ADDR_FROM_ENC* first.
6. Write the required address for the continuous encoder value requests to *ADDR_TO_ENC*.
7. Read out *DATA_FROM_ENC* to finish configuration process. Afterwards, repeated data requests become initiated immediately.

No further encoder value request becomes sent before *DATA_FROM_ENC* has been read out!

14.4 Control via Encoder Feedback

The encoder feedback can be used for controlling *the motion controller outputs* in a way that the internal actual position matches or rather follows the real position *ENC_POS*. Generally, two possibilities for position control are provided: PID control and closed loop operation. Closed loop operation is a very good choice in case the encoder is mounted directly on the back of the motor and position data is evaluated precisely, whereas PID control is well suited where the encoder is located at the drive side and no fixed connection between motor and drive side is given (e.g. belt drives).

The following *regulation_modus* settings are provided:

regulation_modus = b'10 Use this setting for a PID control unit with pulse generator base = 0.
regulation_modus = b'11 Use this setting for a PID control unit with pulse generator base = *VACTUAL*.
regulation_modus = b'01 Use this setting for closed loop operation.

If PID regulation is not selected (*regulation_modus*(1) = 0), the internal velocity which delivers the input for the pulse generator is equal to the ramp velocity (*VEL_ACT_PID* = *VACTUAL*).

14.4.1 PID Based Control of *XACTUAL*

Based on a position difference error $PID_E = XACTUAL - ENC_POS$ the PID (proportional integral differential) controller calculates a signed velocity value (v_{PID}) which is used for minimizing the position error. During this process, the TMC4361 moves with v_{PID} until $|PID_E| - PID_TOLERANCE \leq 0$ is reached and the position error is removed.

v_{PID} is calculated by:
$$v_{PID} = PID_P \cdot e(t) + \int_0^t PID_I \cdot e(t) \cdot dt + PID_D \cdot \frac{d}{dt} \cdot e(t)$$
 with

PID_P = proportional term
PID_I = integral term
PID_D = derivate term

CONTROL PARAMETERS AND CLIPPING VALUES

PID_DV_CLIP To avoid large velocity variations, the v_{PID} value can be limited with *PID_DV_CLIP*. This clipping parameter limits v_{PID} as well as *PID_VEL* (current PID velocity output).

PID_I_CLIP The error sum *PID_ISUM* is generated by the integral term. For limiting *PID_ISUM* set *PID_I_CLIP*. Note that the maximum value of *PID_I_CLIP* should meet the condition $PID_I_CLIP \leq PID_DV_CLIP / PID_I$. If the error sum *PID_ISUM* is not clipped, it is increased with each time step by $PID_I \cdot PID_E$. This continues as long as the motor does not follow.

PID_E Use this register for reading out the actual position deviation between *XACTUAL* and *ENC_POS*.

PID_D_CLKDIV Time scaling for deviation (with respect to error correction periods) is controlled by the *PID_D_CLKDIV* register. Note that during error correction the fixed clock frequency $f_{PID_INTEGRAL} [Hz] = f_{CLK} [Hz] / 128$ is valid.

VEL_ACT_PID The internal velocity *VEL_ACT_PID* alters the current ramp velocity *VACTUAL*. Two settings are provided:
 If *regulation_modus* = b'11, *VACTUAL* is assigned as pulse generator base value and *VEL_ACT_PID* is calculated by $VEL_ACT_PID = VACTUAL + v_{PID}$.
 If *regulation_modus* = b'10, zero is assigned as pulse generator base value. In this case $VEL_ACT_PID = v_{PID}$ is valid.

PID_TOLERANCE The TMC4361 provides the programmable hysteresis *PID_TOLERANCE* for target position stabilization. Oscillations due to error correction can be avoided if *XACTUAL* is close to the real mechanical position. The PID controller of the TMC4361 is programmable up to approximate 100kHz update rate at $f_{CLK} = 16$ MHz. This high speed update rate qualifies it for motion stabilization.

Note that detailed knowledge of a particular application (including dynamics of mechanics) is necessary for PID controller parameterization which is done in a direct way!

14.4.2 Closed Loop Behavior

The closed loop unit of the TMC4361 modifies output currents resp. Step/Dir outputs directly. For closed loop, set *regulation_modus* = b'01. After starting this mode of operation, the closed loop calibration becomes executed and the *CL_OFFSET* value becomes set.

With closed loop, current values are not controlled using the internal step generator. The current values at the SPI output resp. the Step/Dir outputs are verified using the closed loop offset value *CL_OFFSET* which correlates to the evaluated difference between *XACTUAL* and *ENC_POS*. Nevertheless, the internal ramp generator still generates steps for *XACTUAL*.

BASIC PARAMETERS FOR CALIBRATION AND POSITION DEVIATION COMPENSATION

<i>CL_OFFSET</i>	The <i>CL_OFFSET</i> register contains the offset value which is necessary for closed loop operation and offers read-write access. Use the write access in case it is desired to define a fixed offset value which has been tested first.
<i>cl_calibration_en</i>	Set <i>cl_calibration_en</i> = 1 to update/reset <i>CL_OFFSET</i> . For evaluation of a proper value, be sure to meet the following conditions: <ul style="list-style-type: none"> - Maximum current without scaling is used. - <i>VACTUAL</i> is set to 0. - <i>XACTUAL</i> refers to a motor fullstep position.
<i>ENC_POS_DEV</i>	The deviation parameter <i>ENC_POS_DEV</i> contains the deviation between <i>XACTUAL</i> and <i>ENC_POS</i> .
<i>CL_BETA</i>	<i>CL_BETA</i> is the maximum commutation angle which can be used to compensate an evaluated deviation <i>ENC_POS_DEV</i> . If the <i>CL_BETA</i> value becomes reached due to a large difference in microsteps, the <i>CL_MAX</i> event becomes triggered.
<i>CL_TOLERANCE</i>	Set this parameter to choose a tolerance range for position deviation. In case the <i>CL_TOLERANCE</i> value is not exceeded and $ ENC_POS_DEV < CL_TOLERANCE$ the <i>CL_FIT_Flag</i> becomes set. If there has been a mismatch between <i>XACTUAL</i> and <i>ENC_POS</i> before, the <i>CL_FIT</i> event becomes triggered in order to indicate that everything fits now. <p>Note: <i>CL_TOLERANCE</i> is part of <i>PID_TOLERANCE</i>. A <i>PID_TOLERANCE</i> value is automatically chosen if the eight lower <i>CL_TOLERANCE</i> bits are set. The <i>PID_TOLERANCE</i> parameter contains 20 bits. The upper 12 bits can be used for further <i>PID_TOLERANCE</i> adjustment for the PI controller which sets the upper limit for the error correction velocity during closed loop operation.</p>
<i>CL_DELTA_P</i>	<i>CL_DELTA_P</i> is a proportional controller for compensating a detected position deviation. As soon as $ ENC_POS_DEV > CL_TOLERANCE$ the closed loop unit of the TMC4361 multiplies <i>ENC_POS_DEV</i> with <i>CL_DELTA_P</i> and adds the resulting value to the current <i>ENC_POS</i> . Thus, a current commutation angle for higher stiffness for position maintenance clipped at <i>CL_BETA</i> becomes calculated. <p><i>CL_DELTA_P</i> consists of 24 bits. The last 16 bits represent decimal places. Figure 14.5 depicts how register values affect the final output angle at Step/Dir and/or SPI.</p>

The final proportional term is calculated by

$$p_{PID} = \frac{CL_DELTA_P}{65536}$$

Note: the higher the p_{PID} term the faster the reaction on position deviations!

A high p_{PID} term can lead to oscillations which should be avoided. As long as *ENC_POS_DEV* is in the range of $XACTUAL \pm CL_TOLERANCE$, the proportional term is automatically set to 1.

If $|ENC_POS_DEV| > CL_BETA$, the *CL_MAX* event triggers assumed that $|ENC_POS_DEV| < CL_BETA$ has been valid before.

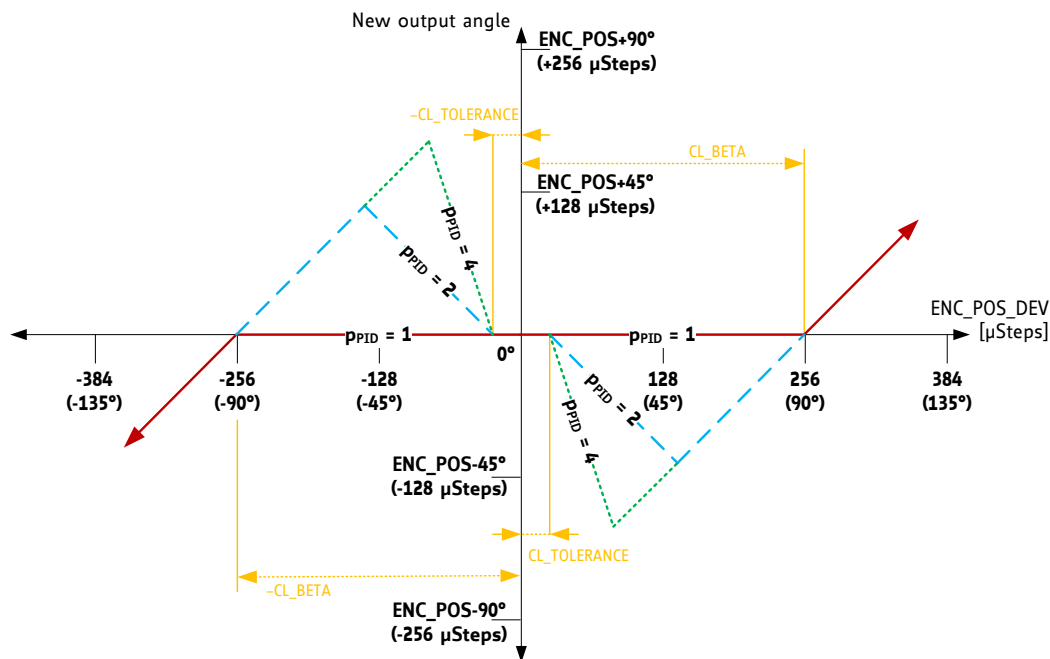

Figure 14.5 Calculation of the output angle by setting CL_DELTA_P properly.

ERROR COMPENSATION IN CASE OF LARGER DEVIATIONS

In case a deviation ENC_POS_DEV between X_ACTUAL and ENC_POS exceeds the certain limit $ENC_POS_DEV_TOL$, X_ACTUAL becomes set to the ENC_POS value, assumed that cl_clr_xact is set to 1. Exceeding $ENC_POS_DEV_TOL$ always sets a status flag ENC_FAIL_Fand triggers the ENC_FAIL event.

VELOCITY REGULATION PARAMETERS

To limit catch-up velocities in case a disturbance of regular motor motion has to be compensated the following parameters can be adjusted.

cl_vlimit_en	Set $cl_vlimit_en = 1$ for limiting the maximum step velocity during closed loop operation. By setting $CL_VMAX_CALC_P$ and/or $CL_VMAX_CALC_I$ accordingly, a PI controller becomes used for velocity regulation of the current ramp. The PI controller calculates the maximum step velocity which is subsequently generated by the closed loop unit.
$CL_VMAX_CALC_P$	P parameter of the PI regulator which controls the maximum velocity.
$CL_VMAX_CALC_I$	I parameter of the PI regulator which controls the maximum velocity.
PID_DV_CLIP	To avoid large velocity variations and to limit the maximum velocity deviation above the maximum velocity $VMAX$, PID_DV_CLIP can be set. PID_DV_CLIP is used with closed loop and for PID controlled operation.
PID_I_CLIP	Together with PID_DV_CLIP this parameter is used for limiting the velocity for error compensation. The error sum PID_ISUM is generated by the integral term. For limiting, set PID_I_CLIP . The maximum value of PID_I_CLIP should meet the condition $PID_I_CLIP \leq PID_DV_CLIP / PID_I$. If the error sum PID_ISUM is not clipped, it is increased with each time step by $PID_I \cdot PID_E$. This continues as long as the motor does not follow. The parameter PID_DV_CLIP is used with closed loop and for PID controlled operation.

In case position deviation at the end of an internal ramp calculation is still left, the SPI and/or Step/Dir output ramp for correction is a linear deceleration ramp, independently from the preset ramp type. This final ramp for error compensation is a function of ENC_POS_DEV and PI control parameters ($CL_VMAX_CALC_P$, $CL_VMAX_CALC_I$, PID_I_CLIP , and PID_DV_CLIP).

Due to the usage of a PI controller for the maximum velocity, the velocity offset depends on ENC_POS_DEV . It is recommended to set a limit for the error correction velocity using PID_DV_CLIP and PID_I_CLIP .

Note that a higher velocity than $VMAX$ resp. $-VMAX$ is possible if the following conditions are met:

- The PI controller is enabled and $PID_DV_CLIP > 0$.
- $CL_VMAX_CALC_P$ and $CL_VMAX_CALC_I$ are higher than 0.
- $ENC_POS_DEV > CL_TOLERANCE$ resp. $ENC_POS_DEV < -CL_TOLERANCE$.

HOW TO BENEFIT FROM THE SCALING UNIT

The TMC4361 provides a scaling unit which can be used during closed loop operation. Therefore, $setclosed_loop_scale_en$ to 1.

HOW THE SCALING UNIT WORKS

1. To decrease current consumption if $XACTUAL$ and ENC_POS match, set CL_IMIN to an appropriate value which is the valid scaling value as long as $|ENC_POS_DEV| \leq CL_START_UP$.
2. In case the threshold value CL_START_UP is exceeded, the current scaling value becomes increased linearly until $|ENC_POS_DEV| = CL_BETA$.
3. If $|CL_BETA|$ is overshoot also, CL_IMAX is the valid current scaling value.

Note that any other scaling becomes disabled if closed loop scaling is enabled!

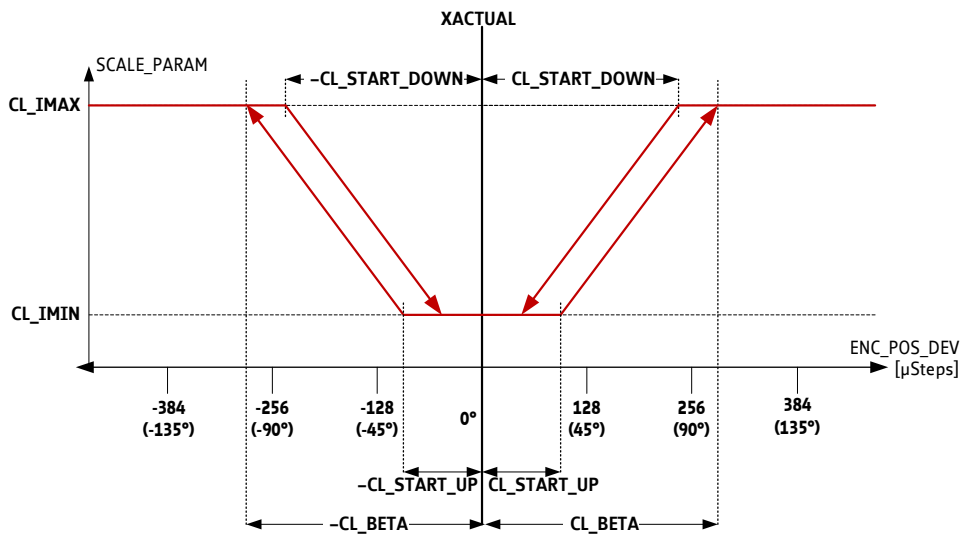

Figure 14.6 Current scaling in with closed loop

In case CL_START_DOWN is set to 0, CL_BETA is the starting point for downscaling. In contrast to the upscaling process the start of downscaling can differ from CL_BETA . Beware of oscillations due to the resulting hysteresis if $CL_START_DOWN \neq CL_BETA$. The current scale parameter which regards to the position deviation ENC_POS_DEV is depicted in Figure 14.6. For evaluating different upscaling and/or downscaling ramps the delay parameters $CL_UPSCALE_DELAY$ and $CL_DNSCALE_DELAY$ can be used, too. These values define the clock cycles which are used to alter the current scale value for one step towards CL_IMAX resp. CL_IMIN . Figure 14.7 depicts the current scaling timing behavior as a function of $CL_UPSCALE_DELAY$ and $CL_DNSCALE_DELAY$.

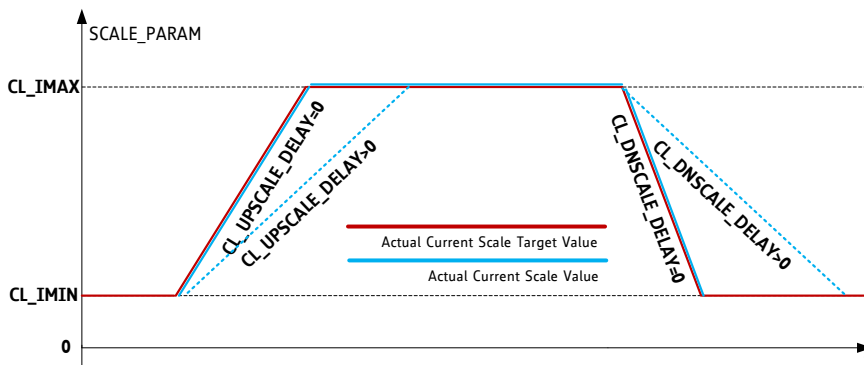

Figure 14.7 Current scaling timing behavior

14.4.3 Special Parameters for ABN Encoders Using Closed Loop

CONSIDERATION OF BACK EMF

For higher motor velocities and ABN encoders the load angle due to back EMF can be compensated. Therefore, set $cl_emf_en = 1$. The compensation angle normally does not exceed CL_BETA , but for back EMF error compensation another angle called $GAMMA$ becomes added. Thereby, the direction of movement is considered.

The $GAMMA$ value is greater than 0 if the encoder velocity V_ENC_MEAN exceeds CL_VMIN_EMF and $GAMMA$ reaches its maximum value CL_GAMMA at $V_ENC_MEAN = CL_VMIN_EMF + CL_VADD_EMF$ as depicted in Figure 14.8.

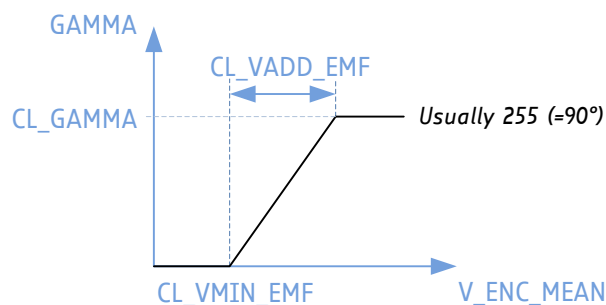

Figure 14.8 Calculation of the current load angle CL_GAMMA

SETTINGS FOR VELOCITY READ OUT

V_ENC	The current encoder velocity V_ENC is calculated with every AB transition. If no AB transitions have been recognized for ENC_VEL_ZERO clock cycles, V_ENC is assigned to 0 and the ENC_VELO event becomes triggered, assumed that the V_ENC value has not been zero before. <i>Note: V_ENC is always set to zero with absolute encoders.</i>
V_ENC_MEAN	Current filtered encoder velocity. This parameter is calculated every ENC_VMEAN_WAIT clock cycles with the filter exponent ENC_VMEAN_FILTER . The parameter V_ENC_MEAN is crucial for CL_GAMMA . It is calculated as follows: $V_ENC_MEAN = \frac{V_ENC_MEAN}{2^{ENC_VMEAN_FILTER}} + \frac{V_ENC}{2^{ENC_VMEAN_FILTER}}$
ENC_VEL_ZERO	Delay time after the last incremental encoder value change. After ENC_VEL_ZERO clock cycles V_ENC_MEAN is set to zero.
ENC_VMEAN_WAIT	Set this time period [clock cycles] to choose a delay before the next current encoder velocity value becomes considered for V_ENC_MEAN calculation. It is recommend to set ENC_VMEAN_WAIT to a higher value than 16!
ENC_VELO	Event becomes triggered: encoder velocity has reached zero.

14.5 Encoder Mismalignments

A deficiently installed encoder can send values which do not result in a circle. Often the deviation from the real position results in a new function which is similar to a sine function. Adding offset that follows a triangular shape can improve the encoder value evaluation significantly (refer to Figure 14.9).

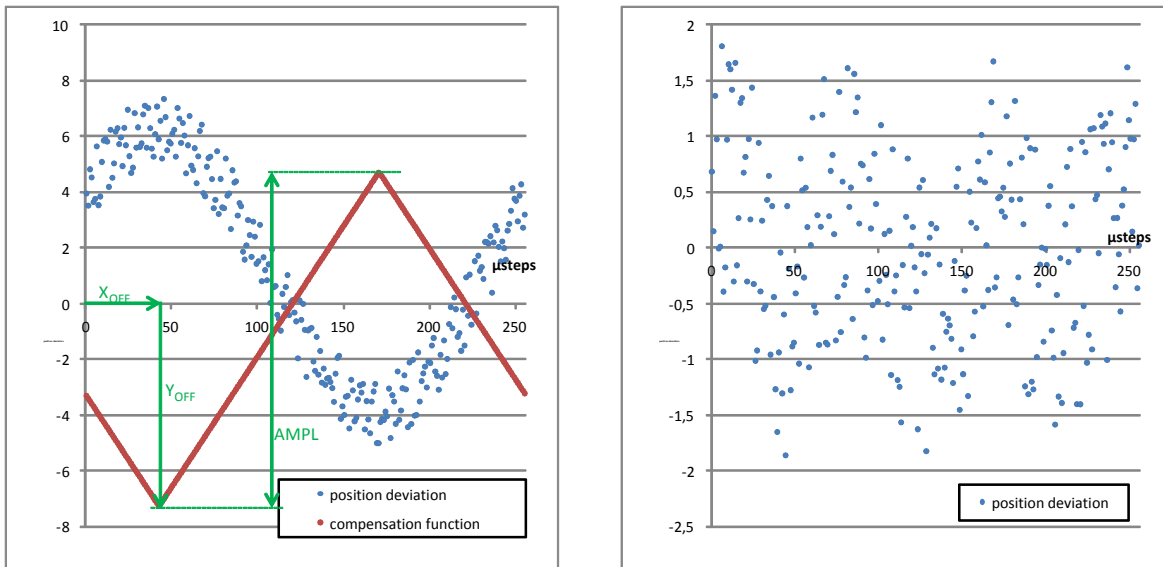

Figure 14.9 Implemented triangular function to compensate for encoder mismalignments

The left graph illustrates the difference between encoder position and real position as a μ step function within the encoder resolution. After error compensation the position differences are minimized significantly as shown on the right side.

For error compensation, the following triangular function has to be calculated and mapped to the deviation function as offset:

$$AMPL - ENC_COMP_AMPL; X_{OFF} - ENC_COMP_XOFFSET; Y_{OFF} - ENC_COMP_YOFFSET$$

Parameter	Description
<i>ENC_COMP_AMPL</i>	Defines the maximum amplitude of the offset function.
<i>ENC_COMP_XOFFSET</i>	Define starting points of the offset function.
<i>ENC_COMP_YOFFSET</i>	

15 Serial Encoder Output Unit

The TMC4361 provides the possibility to render any regular encoder data into absolute SSI encoder data. The absolute SSI data is forwarded using the output pins which are used as normal SPI output otherwise.

PINS AND REGISTERS: SERIAL ENCODER OUTPUT UNIT

Pin names	Type	Remarks
NSCSDRV_SDO	Output	Serial data output
SCKDRV_NSDO	Output	Negated serial data output
SDODRV_SCLK	In/Out as Input	Serial clock input
SDIDRV_NSCLK	Input	Negated serial clock input
Register name	Register address	Remarks
GENERAL_CONF	0x00	RW Bit25 : 24
SSI_OUT_MTIME	0x04	RW Bit24 : 4 Monoflop time of serial encoder output
ENC_IN_CONF	0x07	RW Bit15 : 14, bit30
ENC_OUT_DATA	0x09	RW Number of data bits for encoder output structure
ENC_OUT_RES	0x55	W Resolution of the singleturn data for encoder output

15.1 Providing SSI Output Data

For providing SSI output data the following steps and considerations have to be made:

- Generally, the internal *ENC_POS* is transferred into SSI output data. The structure of the output data can be altered freely to match master requirements.
- For switching from SPI output to SSI output, set *serial_enc_out_enable* to 1. Now, the master clock input *SDO_DRV_SCLK* switches to SSI protocol requirements. Thereafter, *NSCSDRV_SDO* acts as serial data output and sends data.
- Due to the regular differential SSI protocol the particular negated ports are *SCKDRV_NSDO* for data output and *SDI_DRV_NSCLK* for clock input. The evaluation of the differential clock input is based on the digital input levels. If *serial_enc_out_diff_disable* is set to 1, SSI is supported without differential pairs of data input and clock output.
- If *multi_turn_out_en* is set to 1, the output data consists of multiturn and singleturn data. Multiturn data is expressed as a signed number.
- If *multi_turn_out_en* is set to 0, only singleturn data (the angle as microsteps within one revolution) is transferred. The resolution for singleturn data can be set with *ENC_OUT_RES*. The internal *ENC_POS* parameter becomes matched to this resolution.
- Set the number of the single- and multiturn data with *SINGLE_TURN_RES_OUT* resp. *MULTI_TURN_RES_OUT*. The real number of data bits is the given parameter setting + 1 (see Figure 15.1).
- Additionally, the complete data can be gray coded by setting *enc_out_gray* to 1.
- After the last master request transferred data remains unchanged until *SSI_OUT_MTIME* clock cycles are expired to support multi cycle data transfers.

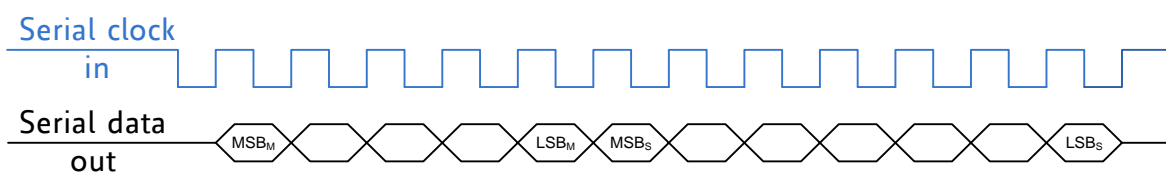

Figure 15.1 Example for SSI output configuration

M: *MULTI_TURN_RES_OUT* = 4 → transfer of 5 multiturn data bits
 S: *SINGLE_TURN_RES_OUT* = 6 → transfer of 7 singleturn data bits

16 CLK Gating

If TMC4361 is not used for a while, clock gating can be used to reduce power consumption.

PINS AND REGISTERS: CLK GATING

Pin names	Type	Remarks	
NSCS_IN	Input	Wakeup signal	
CLK_EXT	Input	Input pin of external clock generator	
Register name	Register address	Remarks	
GENERAL_CONF	0x00	RW	Bit18 : 17
CLK_GATING_DELAY	0x14	RW	Delay time before clock gating is enabled
CLK_GATING_REG	0x4F	RW	Enable trigger for clock gating by setting bit2 : 0 to 111.

16.1 Clock Gating and Wake-up

CONFIGURATION FOR CLOCK GATING

1. To enable clock gating set *clk_gating_en* to 1.
2. Now, clock gating becomes active as soon as *CLK_GATING_REG* is set to 111.
3. For a delay time between setting the register and starting the clock gating itself, *CLK_GATING_DELAY* can be set accordingly. The delay is given in clock cycles.
4. Immediately after the start of the *CLK_GATING_DELAY* timer a *SLEEP_TIMER* event is triggered to indicate a soon clock gating phase.

Clock gating affects every unit except the SPI input unit, the timing unit, and essential registers for freeze processes, which are fed directly by the external clock.

AUTOMATIC CLOCK GATING

It is possible to use automatic clock gating. Therefore, set *clk_gating_stdby_en* to 1. After the TMC4361 has reached the standby state clock gating becomes enabled assumed that *CLK_GATING_DELAY* is set to 0. Else, clock gating becomes started immediately after the clock gating timer expires.

WAKE-UP PROCEDURE

There are three possibilities for wake-up:

- To wake up from clock gating NSCS_IN has to switch to the active low level.
- The wake-up process can be automated by using the internal start signal for ramp initialization. So, shortly before the ramp starts, clock gating is cancelled for loading the essential registers for starting the ramp properly.
- External start signals can also be used to finish clock gating.

Figure 16.1 shows the process of manual clock gating (due to setting the appropriate register) and manual wake up (by using the SPI input lines) including different clock gating delays. First the clock gating timer has to expire and then the second phase of clock gating starts.

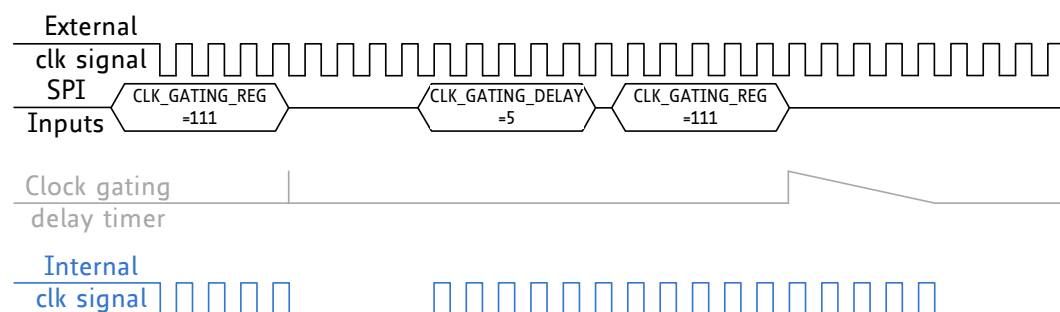

Figure 16.1 Manual clock gating and manual wake up.

Figure 16.2 depicts a complete automatic clock gating transition from inactive to active and back. Here, automatic clock gating is realized using the internal standby status (active high level at *STDBY_CLK* output) and the internal start timer. Clock gating ends slightly before the start signal becomes active. Thus, essential registers can be loaded before ramp start.

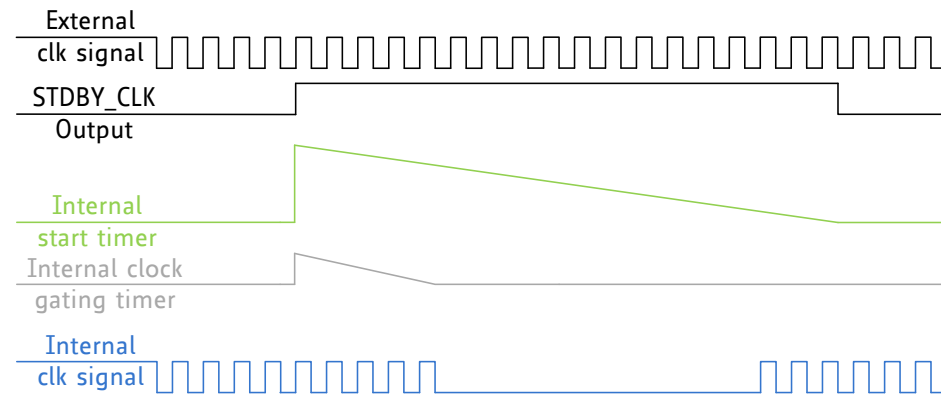

Figure 16.2 Automatic clock gating

Note that manual and automated clock gating transition can be used together.

17 Registers and Switches

17.1 General Configuration

GENERAL CONFIGURATION (0x00)				
R/W	Addr	Reg name	Bit	Description
RW	0x00	<i>GENERAL_CONF</i> Default: 0x00006020	0	Reserved. Set to 0
			1	<i>direct_acc_val_en</i> 0 acceleration values are calculated due to division by the CLK_FREQ 1 acceleration values are set directly as steps per clock cycle
			2	<i>direct_bow_val_en</i> 0 bow values are calculated due to division by CLK_FREQ 1 bow values are set directly as steps per clock cycle
			3	<i>step_inactive_pol</i> 0 STPOUT=1 indicates an active step 1 STPOUT=0 indicates an active step
			4	<i>toggle_step</i> 0 only STPOUT toggling from 0 to 1 or vice versa indicates a step 1 every level change of STPOUT indicates a step
			5	<i>pol_dir_out</i> 0 DIROUT = 0 indicates negative direction 1 DIROUT = 1 indicates negative direction
			9 : 6	Reserved. Set to b'0000
			11 : 10	<i>serial_enc_in_mode</i> 00 incremental encoder connected to encoder interface 01 absolute SSI encoder connected to encoder interface 10 reserved for absolute BiSS encoder 11 absolute SPI encoder connected to encoder interface
			12	<i>diff_enc_in_disable</i> 0 differential encoder interface inputs enabled 1 differential encoder interface inputs disabled (automatically for SPI encoder)
			14 : 13	<i>stdby_clk_pin_assignment</i> 00 Standby signal becomes forwarded with an active low level 01 Standby signal becomes forwarded with an active high level 10 STDBY_CLK passes ChopSync clock (TMC23x, TMC24x only) 11 Internal clock is forwarded to STDBY_CLK output pin
			15	<i>intr_pol</i> 0 INTR=0 indicates an active interrupt 1 INTR=1 indicates an active interrupt
			16	<i>invert_pol_target_reached</i> 0 TARGET_REACHED signal set to 1 indicates target reached event 1 TARGET_REACHED signal set to 0 indicates target reached event
			17	<i>clk_gating_en</i> 0 No clock gating. 1 Internal clock is gated due to clock gating register. A delay until sleep is possible (see clock gating timer register). Wakeup is possible due to active NSCS or if a start signal (internal or external) is generated.
			18	<i>clk_gating_stdby_en</i> 0 No clock gating due to standby phase. 1 Internal clock is gated due to standby of motion controller.

GENERAL CONFIGURATION (0x00)				
R/W	Addr	Reg name	Bit	Description
			19	<i>fs_en</i> 0 No fullsteps. 1 SPI output forwards fullsteps, if $VACTUAL > FS_VEL$. However, the motion controller internally calculates with the current μ Step resolution.
			20	<i>fs_sdout</i> 0 No fullsteps for Step/Dir output. 1 Fullsteps are forwarded via Step/Dir output also.
			22 : 21	Reserved. Set to b'00.
			23	<i>pwm_out_en</i> 0 PWM output disabled (Step/Dir out). 1 STPOUT/DIROUT used as PWM output (PWMA/PWMB).
			24	<i>serial_enc_out_enable</i> 0 No encoder connected to SPI output. 1 SPI output used as SSI encoder interface to pass out absolute SSI encoder data.
			25	<i>serial_enc_out_diff_disable</i> 0 Differential serial encoder output enabled. 1 Differential serial encoder output disabled.
			31 : 26	Reserved. Set to b'000000.

17.2 Reference Switch Configuration

REFERENCE SWITCH CONFIGURATION (0x01)				
R/W	Addr	Reg name	Bit	Description
RW	0x01	REFERENCE_CONF Default: 0x00000000	0	<i>stop_left_en</i> 0 STOPL signal processing disabled. 1 STOPL signal processing enabled.
			1	<i>stop_right_en</i> 0 STOPR signal processing disabled. 1 STOPR signal processing enabled.
			2	<i>pol_stop_left</i> 0 Motorstops if STOPL signal is 0. 1 Motor stops if STOPL signal is 1.
			3	<i>pol_stop_right</i> 0 Motorstops if STOPR signal is 0. 1 Motor stops if STOPR signal is 1.
			4	<i>invert_stop_direction</i> 0 STOPL/STOPR stop motor in negative/positive direction. 1 STOPL/STOPR stop motor in positive/negative direction.
			5	<i>soft_stop_en</i> 0 Hard stop enabled. <i>VACTUAL</i> is immediately set to 0 on any external stop event. 1 Soft stop enabled. A linear velocity ramp is used for decreasing <i>VACTUAL</i> to $v = 0$.
			6	<i>virtual_left_limit_en</i> 0 Position limit <i>VIRT_STOP_LEFT</i> disabled. 1 Position limit <i>VIRT_STOP_LEFT</i> enabled.
			7	<i>virtual_right_limit_en</i> 0 Position limit <i>VIRT_STOP_RIGHT</i> disabled. 1 Position limit <i>VIRT_STOP_RIGHT</i> enabled.
			9 : 8	<i>virt_stop_mode</i> 00 The current ramp type defines the deceleration ramp triggered by a virtual stop event. 01 <i>VACTUAL</i> is set to 0 on a virtual stop event (hard stop) 10 Soft stop is enabled with linear velocity ramp (from <i>VACTUAL</i> to $v = 0$).
			10	<i>latch_x_on_inactive_l</i> 0 No latch of <i>XACTUAL</i> if <i>STOPL</i> becomes inactive. 1 <i>X_LATCH</i> = <i>XACTUAL</i> will be triggered if <i>STOPL</i> becomes inactive.
			11	<i>latch_x_on_active_l</i> 0 No latch of <i>XACTUAL</i> if <i>STOPL</i> becomes active. 1 <i>X_LATCH</i> = <i>XACTUAL</i> will be triggered if <i>STOPL</i> becomes active.
			12	<i>latch_x_on_inactive_r</i> 0 No latch of <i>XACTUAL</i> if <i>STOPR</i> becomes inactive. 1 <i>X_LATCH</i> = <i>XACTUAL</i> will be triggered if <i>STOPR</i> becomes inactive.
			13	<i>latch_x_on_active_r</i> 0 No latch of <i>XACTUAL</i> if <i>STOPR</i> becomes active. 1 <i>X_LATCH</i> = <i>XACTUAL</i> will be triggered if <i>STOPR</i> becomes active.
			14	<i>stop_left_is_home</i> 0 STOPL input signal is not HOME position. 1 STOPL input signal is also HOME position.
			15	<i>stop_right_is_home</i> 0 STOPR input signal is not HOME position. 1 STOPR input signal is also HOME position.

REFERENCE SWITCH CONFIGURATION (0x01)				
R/W	Addr	Reg name	Bit	Description
			19 : 16	<p><i>home_event</i></p> <p>0000 Next active N signal of ABN encoder signal indicates HOME position.</p> <p>0011 HOME = 0 indicates negative region/position from home.</p> <p>1100 HOME = 1 indicates negative region/position from home.</p> <p>0110 HOME = 1 indicates an active home event- X_HOME is located in the middle of the active range.</p> <p>0010 HOME = 1 indicates an active home event- X_HOME is located at the rising edge of the active range.</p> <p>0100 HOME = 1 indicates an active home event- X_HOME is located at the falling edge of the active range.</p> <p>1001 HOME = 0 indicates an active home event- X_HOME is located in the middle of the active range.</p> <p>1011 HOME = 0 indicates an active home event- X_HOME is located at the rising edge of the active range.</p> <p>1101 HOME = 0 indicates an active home event- X_HOME is located at the falling edge of the active range.</p>
			20	<p><i>start_home_tracking</i></p> <p>0 No storage of X_HOME = XACTUAL by passing home position next time.</p> <p>1 Storage of XACTUAL as X_HOME at next regular home event (becomes reset automatically as indication for a regular setting).</p>
			21	<p><i>clr_pos_at_target</i></p> <p>0 Ramp stops at XTARGET if positioning mode is active.</p> <p>1 Set XACTUAL = 0 after XTARGET has been reached. The next ramp starts immediately.</p>
			22	Reserved. Set to 0.
			24 : 23	<p><i>pos_comp_output</i></p> <p>00 TARGET_REACHED is set active on TARGET_REACHED event.</p> <p>11 TARGET_REACHED triggers on POSCOMP_REACHED event.</p>
			25	<p><i>pos_comp_source</i></p> <p>0 POS_COMP is compared to internal position XACTUAL.</p> <p>1 POS_COMP is compared with external position ENC_POS.</p>
			26	<p><i>stop_on_stall</i></p> <p>0 Motor will not be stopped in case of stall.</p> <p>1 Motor will be stopped with a hard stop in case of stall.</p>
			27	<p><i>drv_after_stall</i></p> <p>Set to 1 and reset stop_on_stall flag. Moving the motor is not possible as long as this flag is active after a stop_on_stall event.</p>
			31 : 28	Reserved. Set to b'0000.

17.3 Start Switch Configuration

START SWITCH CONFIGURATION (0x02)				
R/W	Addr	Reg name	Bit	Description
RW	0x02	START_CONF		<i>start_en</i> 000 No start signal necessary for ramp start. xx1 Change of <i>XTARGET</i> requires a distinct start signal. x1x Change of <i>VMAX</i> requires a distinct start signal. 1xx Change of <i>RAMPMODE</i> requires a distinct start signal.
		Default: 0x00000000	2 : 0	
			4 : 3	Reserved. Set to b'00.
			8 : 5	<i>trigger_events</i> xxx1 External START signal is assigned as start signal for timer. Set also <i>start_en</i> = 1 to use START pin as input. xxx0 START pin is assigned as output. xx1x <i>TARGET_REACHED</i> event is assigned as start signal for timer. x1xx <i>VELOCITY_REACHED</i> event is assigned as start signal for timer. 1xxx <i>POSCOMP_REACHED</i> event is assigned as start signal for timer.
			9	<i>pol_start_signal</i> (same polarity for input or output) 0 START = '0' is active start polarity 1 START = '0' is inactive start polarity
			10	<i>immediate_start_in</i> 0 Active START input starts internal start timer 1 Active START will be executed immediately
			11	Reserved: Set to '0'
			12	<i>x_pipeline_en</i> 0 No target pipeline enabled. 1 <i>X_TARGET</i> is changed related to the value in register <i>X_PIPE0</i> . <i>X_PIPE</i> is changed related to the value of register <i>X_PIPEx+1</i> .
			23 : 13	Reserved. Set to b'00000000000.
			31 : 24	<i>XPIPE_REWRITE_REG</i> Indicates which <i>X_PIPE</i> register becomes changed to <i>XACTUAL</i> value on next internal start event and if <i>x_pipeline_en</i> = 1.

17.4 Input Filter Configuration

INPUT FILTER CONFIGURATION (0x03)				
R/W	Addr	Reg name	Bit	Description
RW	0x03	<i>INPUT_FILT_CONF</i> Default: 0x00000000	2 : 0	<i>SR_ENC_IN</i> Input sample rate = $f_{CLK}/2^{SR_ENC_IN}$ for A_SCLK, ANEG_NSCLK, B_SDI, BNEG_NSDI, N, and NNEG
			3	Reserved. Set to 0.
			6 : 4	<i>FILT_L_ENC_IN</i> # additionally sampled input bits whose voltage level has to be equal to the recently sampled bit to provide a valid input bit level for A_SCLK, ANEG_NSCLK, B_SDI, BNEG_NSDI, N, and NNEG.
			7	Reserved. Set to 0.
			10 : 8	<i>SR_REF</i> Input sample rate = $f_{CLK} / 2^{SR_REF}$ for STOPR, HOME_REF, and STOPL.
			11	Reserved. Set to 0.
			14 : 12	<i>FILT_L_REF</i> # additionally sampled input bits whose voltage level has to be equal to the recently sampled bit to provide a valid input bit level for STOPR, HOME_REF, and STOPL.
			15	Reserved. Set to 0.
			18 : 16	<i>SR_S</i> Input sample rate = $f_{CLK} / 2^{SR_S}$ for START.
			19	Reserved. Set to 0.
			22 : 20	<i>FILT_L_S</i> # additionally sampled input bits whose voltage level has to be equal to the recently sampled bit to provide a valid input bit level for START.
			23	Reserved. Set to 0.
			26 : 24	<i>SR_ENC_OUT</i> Input sample rate = $f_{CLK} / 2^{SR_ENC_OUT}$ for SDODRV_SCLK, and SDIDRV_NSCLK.
			27	Reserved. Set to 0.
			30 : 28	<i>FILT_L_ENC_OUT</i> # additionally sampled input bits whose voltage level has to be equal with the recently sampled bit to provide a valid input bit level for SDODRV_SCLK, and SDIDRV_NSCLK
			31	Reserved. Set to 0.

17.5 SPI-Out Configuration

SPI-OUT CONFIGURATION (0x04)			
R/W	Addr	Reg name	Bit Description
RW	0x04	<i>SPIOUT_CONF</i>	BASIC SPI-OUT SETTINGS
		Default: 0x00000000	<i>spi_output_format</i> 0000 SPI-Out off 1000 SPI-Out connected to TMC23x driver 1001 SPI-Out connected to TMC24x driver 1010 SPI-Out connected to TMC26x/389 1011 SPI-Out connected to TMC26x/389. Steps only via STPOUT. 1100 SPI-Out connected to TMC21xx. Steps only via STPOUT. 1101 SPI-Out connected to TMC21xx. 0100 The actual unsigned scaling factor is assigned to SPI-Out. 0101 Both actual signed SinLUT values are assigned to SPI-Out. 0110 The actual unsigned scaling factor is merged with DAC_ADDR_A as output for a SPI-DAC. 0010 SPI-Out is connected with a DAC. Absolute values. Phase of coilA via STPOUT. Phase of coilB via DIROUT. Phase bit = 0 → positive values. 0011 SPI-Out is connected with a DAC. Absolute values. Phase of coilA via STPOUT. Phase of coilB via DIROUT. Phase bit = 1 → positive values. 0001 SPI-Out is connected with a DAC. Values are mapped. Current = 0 → VDD/2 Current = -(max_value) → 0 Current = max_value → VDD
			3 : 0
			19 : 13 <i>COVER_DATA_LENGTH</i> (0..64) Set to 0 for automatic assign, if a TMC driver is connected. Otherwise it will set to 1 if <i>COVER_DATA_LENGTH</i> = 0 and no TMC driver is selected.
			23 : 20 <i>SPI_OUT_LOW_TIME</i> SPI-Output clock low phase [clock cycles]
			27 : 24 <i>SPI_OUT_HIGH_TIME</i> SPI-Output clock high phase [clock cycles]
			31 : 28 <i>SPI_OUT_BLOCK_TIME</i> SPI-Output blockage time [clock cycles]
			SETTINGS USED WITH SERIAL ENCODER OUTPUT ONLY:
			<i>serial_enc_out_enable</i> = 1
			23 : 4 <i>SSI_OUT_MTIME</i> SSI output monoflop time: delay time during which the absolute data remain stable after the last master request.[clock cycles]

SPI-OUT CONFIGURATION (0x04)				
R/W	Addr	Reg name	Bit	Description
			SETTINGS USED WITH TMC23X/24X MOTOR DRIVERS ONLY: <i>spi_output_format</i> (3 : 1) = b'100	
			5 : 4	<i>mixed_decay</i> (coilA and coilB for a TMC23x or TMC24x driver) 00 Both mixed decay bits are always off. 01 During falling ramps until reaching the value of 0 mixed decay bits are on. 10 Both mixed decay bits are always on, except standby mode is active. 11 Both mixed decay bits are always on.
			6	<i>stbby_on_stall_for_24x</i> (TMC24x only) 0 No standby datagram. 1 In case of a <i>stop_on_stall</i> event a standby datagram is sent to the TMC24x driver.
			7	<i>stall_flag_instead_of_uv_en</i> (TMC24x only) 0 Undervoltage flag is forwarded as <i>status_flag</i> (24). 1 Calculated stall status of TMC24x is forwarded as <i>status_flag</i> (24).
			10 : 8	<i>STALL_LOAD_LIMIT</i> (TMC24x only) A stall is detected if <i>STALL_LOAD_LIMIT</i> ≥ (LD2&LD1&LD0) of the driver status.
			SETTINGS USED WITH TMC26XX/21XX MOTOR DRIVER ONLY: <i>spi_output_format</i> = b'101x or b'110x	
			4	<i>three_phase_stepper_en</i> (TMC26x/389 only) 0 A 2-phase stepper driver is connected (TMC26x) 1 A 3-phase stepper driver is connected (TMC389)
			5	<i>scale_val_transfer_en</i> 0 No transfer of scale values to the TMC driver. 1 Transfer of current scale values to the correct driver registers.
			6	<i>disable_polling</i> 0 Permanent transfer of datagrams to check driver status (Step/Dir output only) 1 No transfer of polling datagrams. (recommended for <i>spi_output_format</i> = b'1101)
			12 : 7	<i>POLL_BLOCK_MULT</i> Multiplier for calculating the time interval between consecutive polling datagrams. $t_{POLL} = (POLL_BLOCK_MULT+1) \cdot SPI_OUT_BLOCK_TIME / f_{CLK}$
			SETTINGS USED WITH MOTOR DRIVERS FROM THIRD PARTIES: <i>spi_output_format</i> (3) = 0	
			4	<i>sck_low_before_csn</i> 0 NSCSDRV_SDO tied low before SCKDRV_NSDO 1 SCKDRV_NSDO tied low before NSCSDRV_SDO
			5	<i>new_out_bit_at_rise</i> 0 SDODRV_SCLK is shifted at falling edge of SCKDRV_NSDO. 1 SDODRV_SCLK is shifted at rising edge of SCKDRV_NSDO.
			11 : 7	<i>DAC_CMD_LENGTH</i> # of bits for command address if <i>spi_output_format</i> = b'0001 or b'0010 or b'0011 or b'0110.

17.6 Current Configuration

CURRENT CONFIGURATION (0x05)				
R/W	Addr	Reg name	Bit	Description
RW	0x05	CURRENT_CONF		
		Default: 0x00000000	0	<i>hold_current_scale_en</i> 0 No hold current scaling during standby phase. 1 Hold current scaling during standby phase.
			1	<i>drive_current_scale_en</i> 0 No drive current scaling during motion. 1 Drive current scaling during motion.
			2	<i>boost_current_on_acc_en</i> 0 No boost current scaling for acceleration ramps. 1 Boost current scaling if RAMP_STATE = b'01.
			3	<i>boost_current_on_dec_en</i> 0 No boost current scaling for deceleration ramps. 1 Boost current scaling if RAMP_STATE = b'10.
			4	<i>boost_current_after_start_en</i> 0 No boost current at ramp start. 1 Temporary boost current if VACTUAL = 0 and new ramp starts.
			5	<i>sec_drive_current_scale_en</i> 0 One drive current value for the whole motion ramp. 1 Second drive current scaling for VACTUAL > VDRV_SCALE_LIMIT.
			6	<i>freewheeling_en</i> 0 No freewheeling. 1 Freewheeling after standby phase.
			7	<i>closed_loop_scale_en</i> 0 No closed loop current scaling. 1 Closed loop current scaling – CURRENT_CONF(6 : 0) = 0 is set automatically <i>Turn off for closed loop calibration with maximum current!</i>
			31 : 9	Reserved. Set to 0x000000.

17.7 Current Scale Values

CURRENT SCALE VALUES (0x06)				
R/W	Addr	Reg name	Bit	Description
RW	0x06	SCALE_VALUES		
		Default: 0xFFFFFFFF	7 : 0	<i>BOOST_SCALE_VAL</i> : Open loop boost scaling value. <i>CL_IMIN</i> : closed loop minimum scaling value.
			15 : 8	<i>DRV1_SCALE_VAL</i> : Open loop first drive scaling value. <i>CL_IMAX</i> : closed loop maximum scaling value.
			23 : 16	<i>DRV2_SCALE_VAL</i> : Open loop second drive scaling value. <i>CL_START_UP</i> : ENC_POS_DEV value at which closed loop scaling increases the current scaling value above <i>CL_IMIN</i> .
			31 : 24	<i>HOLD_SCALE_VAL</i> : Open loop standby scaling value. <i>CL_START_DOWN</i> : ENC_POS_DEV value at which closed loop scaling decreases the current scaling value below <i>CL_IMAX</i> . If set to 0 it is automatically equal to <i>CL_BETA</i> .
			15 : 0	<i>PWM_AMPL</i> : PWM amplitude at VACTUAL = 0. Maximum duty cycle = $(0.5 + (PWM_AMPL + 1) / 2^{17})$ Minimum duty cycle = $(0.5 - (PWM_AMPL + 1) / 2^{17})$ $PWM_AMPL = 2^{16} - 1$ at VACTUAL = PWM_VMAX

BOOST_SCALE_VAL, DRV1/DRV2_SCALE_VAL, HOLD_SCALE_VAL, CL_IMIN, CL_IMAX

Real scaling value = $(x+1) / 32$ if *spi_output_format* = b'1011 or b'1100
= $(x+1) / 256$ any other *spi_output_format* setting

17.8 Encoder Signal Configuration

ENCODER SIGNAL CONFIGURATION (0x07)				
R/W	Addr	Reg name	Bit	Description
RW	0x07	ENC_IN_CONF		<i>enc_sel_decimal</i>
		Default: 0x00000400	0	0 Encoder constant represents a binary number. 1 Encoder constant represents a decimal number (for ABN only).
			1	<i>clear_on_n</i> 0 ENC_POS is not set to 0. 1 ENC_POS is set to 0 on every N event. <i>Do not use for closed loop operation!</i>
			2	<i>clr_latch_cont_on_n</i> 1 Value of ENC_POS is cleared and/or latched to ENC_LATCH register on every N event.
			3	<i>clr_latch_once_on_n</i> 1 Value of ENC_POS is cleared and/or latched to ENC_LATCH register on the next N event. <i>This bit is set to 0 after latching/clearing once.</i>
			4	<i>pol_n</i> 0 Active polarity for N event is low level. 1 Active polarity for N event is high level.
			6 : 5	<i>n_chan_sensitivity</i> 00 N event is active as long as N is active. 01 N event triggers when N becomes active (positive edge). 10 N event triggers when N becomes inactive (negative edge) 11 N event triggers when N becomes active or inactive (both edges)
			7	<i>pol_a_for_n</i> 0 A polarity has to be low for a valid N event. 1 A polarity has to be high for a valid N event.
			8	<i>pol_b_for_n</i> 0 B polarity has to be low for a valid N event 1 B polarity has to be high for a valid N event
			9	<i>ignore_ab</i> 0 Consider A and B polarities for a valid N event. 1 Ignore polarities of A and B signals for a valid N event.
			10	<i>latch_enc_on_n</i> 0 no latch of ENC_POS on an active N event 1 ENC_LATCH = ENC_POS triggered on an active N event
			11	<i>latch_x_on_n</i> 0 Do not latch XACTUAL on active N event. 1 X_LATCH = XACTUAL triggered on an active N event.
			12	<i>multi_turn_in_en</i> 0 Serial encoder input transmits singleturn values. 1 Serial encoder input transmits singleturn and multiturn values.
			13	<i>multi_turn_in_signed</i> 0 Multiturn values from serial encoder input are unsigned numbers. 1 Multiturn values from serial encoder input are signed numbers.
			14	<i>multi_turn_out_en</i> 0 Serial encoder output transmits singleturn values. 1 Serial encoder output transmits singleturn and multiturn values.
			15	Reserved. Set to 0.
			16	<i>calc_multi_turn_behav</i> 0 No multiturn calculation. 1 Multiturn calculation for singleturn encoder data.
			17	<i>ssi_multi_cycle_data</i> 0 Every absolute SSI value request is executed once. 1 Every absolute SSI value request is executed twice.

ENCODER SIGNAL CONFIGURATION (0x07)				
R/W	Addr	Reg name	Bit	Description
			18	<i>ssi_gray_code_en</i> 0 SSI input data is binary coded. 1 SSI input data is gray coded.
			19	<i>left_aligned_data</i> 0 Serial input data is aligned right (first flags, then data). 1 Serial input data is aligned left (first data, then flags).
			20	<i>spi_data_on_cs</i> (SPI encoder only (serial_enc_in_mode = b'11)) 0 BNEG_NSIDI will provide output data at next A_SCLK transition 1 BNEG_NSIDI will provide output data immediately if ANEG_NSCLK input signal level is tied low transition
			21	<i>spi_low_before_cs</i> (SPI encoder only (serial_enc_in_mode = b'11)) 0 A_SCLK will tied low after ANEG_NSCLK switches to low level 1 A_SCLK will tied low before ANEG_NSCLK switches to low level
			23 : 22	<i>regulation_modus</i> 00 No feedback consideration. 01 Closed loop operation. 10 PID regulation. Pulse generator base is zero. 11 PID regulation. Pulse generator base is <i>VACTUAL</i> .
			24	<i>cl_calibration_en</i> 0 No closed loop calibration. 1 Closed loop calibration is active. <i>Use maximum current without scaling during calibration! The motor driver must stay at a fullstep position and VACTUAL has to be set to 0 during the calibration process!</i>
			25	<i>cl_emf_en</i> 0 Do not consider back EMF during closed loop operation. 1 Closed loop operation considers back EMF if <i>VACTUAL</i> > <i>CL_VMIN</i> .
			26	<i>cl_clr_xact</i> 0 <i>ENC_POS_DEV</i> will not be evaluated to manipulate <i>X_ACTUAL</i> 1 <i>X_ACTUAL</i> = <i>ENC_POS</i> , if <i>ENC_POS_DEV</i> > <i>ENC_POS_DEV_TOL</i>
			27	<i>cl_vlimit_en</i> 0 No maximum velocity limit for closed loop regulation. 1 PI maximum velocity regulation during closed loop operation.
			28	Reserved. Set to 0.
			29	<i>invert_enc_dir</i> : Set this parameter to 1 for inverting the <i>ENC_POS</i> value. Do not use this for serial encoder.
			30	<i>enc_out_gray</i> 0 SSI output data is binary coded. 1 SSI output data is gray coded.
			31	<i>no_enc_vel_preproc</i> 0 AB signal is preprocessed for encoder velocity. This setting can only be used with <i>serial_enc_in_mode</i> = b'00. Set <i>no_enc_vel_preproc</i> to 1 to end AB signal preprocessing. <i>serial_enc_variation_limit</i> 1 Two consecutive serial encoder values must not vary more than one eighth of the encoder resolution <i>ENC_IN_RES</i> to be valid. This setting can only be used with <i>serial_enc_in_mode</i> ≠ 00.

17.9 Serial Encoder Data IN

SERIAL ENCODER DATA IN (0x08)				
R/W	Addr	Reg name	Bit	Description
RW	0x08	<i>ENC_IN_DATA</i> Default: 0x00000000	4 : 0	<i>SINGLE_TURN_RES</i> # data bits for angle within one revolution = <i>SINGLE_TURN_RES</i> + 1.
			9 : 5	<i>MULTI_TURN_RES</i> # data bits for revolution count = <i>MULTI_TURN_RES</i> + 1.
			11 : 10	<i>STATUS_BIT_CNT</i> : # bits of status data
			15 : 12	<i>CRC_BIT_CNT</i> : Length of CRC polynomial (#bits)
			23 : 16	<i>SERIAL_ADDR_BITS</i> # bits for addresses within SPI datagram.
			31 : 24	<i>SERIAL_DATA_BITS</i> # bits for data within SPI datagram.

17.10 Serial Encoder Data OUT

SERIAL ENCODER DATA OUT (0x09)				
R/W	Addr	Reg name	Bit	Description
RW	0x09	<i>ENC_OUT_DATA</i> Default: 0x00000000	4 : 0	<i>SINGLE_TURN_RES_OUT</i> : # data bits for angle within one revolution = <i>SINGLE_TURN_RES_OUT</i> + 1.
			9 : 5	<i>MULTI_TURN_RES_OUT</i> # data bits for revolution count = <i>MULTI_TURN_RES_OUT</i> + 1.
			31 : 10	Reserved. Set all bits to 0.

17.11 Motor Driver Settings

MOTOR DRIVER SETTINGS (0x0A)				
R/W	Addr	Reg name	Bit	Description
RW	0x0A	<i>STEP_CONF</i> Default: 0x00FBOC80	3 : 0	<i>MSTEP_PER_FS</i> b'0000 Highest μ step resolution: 256 μ steps per fullstep. b'0001... b'0111 128 μ steps ... half steps b'1000 Full steps (maximum possible setting) Note: - Set to 256 for closed loop operation. - When using a Step/Dir driver, it must be capable of a 256 resolution via Step/Dir input for best performance (but lower resolution Step/Dir drivers can be used as well).
			15 : 4	<i>FS_PER_REV</i> : Fullsteps per revolution
			23 : 16	<i>MSTATUS_SELECTION</i> : ORed with Motor Driver Status Register Set (7 : 0) → if set here & particular flag is set, an event will be generated at EVENTS(30)
			31 : 24	Reserved: Set to b'00000000

17.12 Event Selection Registers

EVENT SELECTION				
R/W	Addr	Reg name	Bit	Description
RW	0x0B	<i>SPI_STATUS_SELECTION</i> Default: 0x82029805	31 : 0	Events which bits are selected (=1) in this register are forwarded to the eight status bits that are transferred with every SPI datagram (first eight bits from LSB are significant!).
	0x0C	<i>EVENT_CLEAR_CONF</i> Default: 0x00000000	31 : 0	Events which bits are selected (=1) in this register are not cleared with reading out the EVENTS register 0x0E.
	0x0D	<i>INTR_CONF</i> Default: 0x00000000	31 : 0	ORed with interrupt event register set → if set here and the particular flag is set an interrupt becomes generated.

17.13 Status Event Register

STATUS EVENTS (0x0E)				
R/W	Addr	Reg name	Bit	Description
R+C	0x0E	EVENTS Default: 0x00000000	0	TARGET_REACHED has been triggered.
			1	POS_COMP_REACHED has been triggered.
			2	VEL_REACHED has been triggered.
			3	VEL_STATE = b'00 has been triggered (v=0).
			4	VEL_STATE = b'01 has been triggered (v>0).
			5	VEL_STATE = b'10 has been triggered (v<0).
			6	RAMP_STATE = b'00 has been triggered (a=0).
			7	RAMP_STATE = b'01 has been triggered (a >0).
			8	RAMP_STATE = b'10 has been triggered (<a <0).
			9	MAX_PHASE_TRAP: Trapezoidal ramp has reached its limit speed using maximum values for A_MAX and D_MAX for acceleration/deceleration (V_ACTUAL > V_BREAK; V_BREAK ≠ 0).
			10	FREEZED: N_FREEZE has been tied low. <i>Reset TMC4361 for further motion!</i>
			11	STOPL has been triggered. Movement in negative direction is not executed until this event is cleared and (STOPL is not active any more or stop_left_en is set to 0).
			12	STOPR has been triggered. Movement in positive direction is not executed until this event is cleared and (STOPR is not active any more or stop_right_en is set to 0).
			13	VSTOPL_ACTIVE: VSTOPL has been activated. No further movement in negative direction until this event is cleared and (a new value is chosen for VSTOPL or X_ACTUAL or set virtual_left_limit_en = 0).
			14	VSTOPR_ACTIVE: VSTOPR has been activated. No further movement in positive direction until this event is cleared and (a new value is chosen for VSTOPR or X_ACTUAL or set virtual_right_limit_en = 0).
			15	HOME_ERROR: HOME_REF has wrong polarity and is outside of safety margin around X_HOME.
			16	XLATCH_DONE: indicates if X_LATCH has been newly written.
			17	FS_ACTIVE: Fullstep has been activated.
			18	ENC_FAIL: Mismatch between X_ACTUAL and ENC_POS has been triggered.
			19	N_ACTIVE: Active N event has been triggered.
			20	ENC_DONE indicates if ENC_LATCH has been newly written.
			21	SER_ENC_DATA_FAIL: Failure during multi cycle data evaluation or between two consecutive data requests.
			22	CRC_FAIL: indication of a failure occurrence during CRC calculation.
			23	SER_DATA_DONE: Data has been received from serial encoder (SPI).
			24	reserved
			25	COVER_DONE: SPI datagram have been sent to the motor driver.
			26	ENC_VELO: Encoder velocity has been reached 0.
			27	CL_MAX: Closed loop commutation angle has reached maximum value.
			28	CL_FIT: CL_FIT_F has been triggered.
			29	STOP_ON_STALL: Motor stall detected. Motor has been stopped.
			30	MOTOR_EV: One of the chosen TMC motor driver flags has been triggered.
			31	SLEEP_TIMER has been started.

17.14 Status Flag Register

STATUS FLAGS (0x0F)							
R/W	Addr	Reg name	Bit	Description			
R	0x0F	STATUS Default: 0x00000000	0	TARGET_REACHED_Fis set high if XACTUAL = XTARGET			
			1	POS_COMP_REACHED_F is set high if XACTUAL = POS_COMP			
			2	VEL_REACHED_F is set high if VACTUAL = abs(VMAX)			
			4 : 3	VEL_STATE_F: Current velocity state:	00 VACTUAL=0	01 VACTUAL>0	10 VACTUAL<0
			6 : 5	RAMP_STATE_F: Current ramp state.	00 AACTUAL=0	01 Acceleration phase: AACTUAL>0 if VACTUAL>0 or AACTUAL<0 if VACTUAL<0	10 Deceleration phase: AACTUAL<0 if VACTUAL>0 or AACTUAL>0 if VACTUAL<0
			7	STOPL_ACTIVE_F: Left stop switch is active.			
			8	STOPR_ACTIVE_F: Right stop switch is active.			
			9	VSTOPL_ACTIVE_F: Left virtual stop switch is active.			
			10	VSTOPR_ACTIVE_F: Right virtual stop switch is active.			
			11	ACTIVE_STALL_F: Motor stall is detected and VACTUAL > VSTALL_LIMIT.			
			12	HOME_ERROR_F HOME_REF input signal level is not equal to the expected home level			
			13	FS_ACTIVE_F: Fullstep operation is active.			
			14	ENC_FAIL_F: Mismatch between XACTUAL and ENC_POS is out of tolerated range ENC_POS_DEV_TOL.			
			15	N_ACTIVE_F: N event is active.			
			16	ENC_LATCH_F: ENC_LATCH is newly written.			
			17	MULTI_CYCLE_FAIL_F (serial_enc_in_mode ≠ 00): indicates a failure during last multi cycle data evaluation. SER_ENC_VAR_F (serial_enc_in_mode ≠ 00): indicates a failure during last serial data evaluation due to a substantial deviation between two consecutive serial data values (serial_enc_variation_limit = 1).The variation is bigger than one eighth of ENC_IN_RES.			
			18	CRC_FAIL_F: Failure has been calculated during last CRC evaluation. This status flag becomes reset with the next error-free CRC calculation.			
			19	CL_FIT_F: Active if ENC_POS_DEV < CL_TOLERANCE. The current mismatch between XACTUAL and ENC_POS is within tolerated range.			
			23 : 20	Reserved for BiSS flags from encoder.			
			24	SG: StallGuard2 status (rcvd from TMC26x / TMC21xx motor driver) or stallGuard status (calculated for TMC24x). UV_SF: Undervoltage flag (rcvd from TMC23x / TMC24x motor driver).			
			25	OT: Overtemperature shutdown (rcvd from any TMC motor driver).			
			26	OTPW: Overtemperature warning (rcvd from any TMC motor driver).			
			27	S2GA: Short to ground detection bit for high side MOSFET of coil A (rcvd from TMC26x / TMC21xx motor driver). OCA: Overcurrent bridge A (rcvd from TMC23x / TMC24x motor driver).			
			28	S2GB: Short to ground detection bit for high side MOSFET of coil B (rcvd from TMC26x / TMC21xx motor driver). OCB: Overcurrent bridge B (rcvd from TMC23x / TMC24x motor driver).			
			29	OLA: Open load indicator of coil A (rcvd from any TMC motor driver).			
			30	OLB: Open load indicator of coil B (rcvd from any TMC motor driver).			
			31	STST: Standstill indicator (rcvd from TMC26x / TMC21xx motor driver). OCHS: Overcurrent high side (rcvd from TMC23x / TMC24x motor driver).			

17.15 Various Configuration Registers

VARIOUS CONFIGURATION REGISTERS: CLOSED LOOP, SWITCHES...					
R/W	Addr	Reg name (default)	S/U	Bit	Description
RW	0x10	STP_LENGTH_ADD (0x0000)	U	15 : 0	Additional length [# clock cycles] for active step polarity to indicate an active output step at STPOUT
		DIR_SETUP_TIME (0x0000)		31 : 16	Delay [# clock cycles] between DIROUT and STPOUT voltage level changes.
	0x11	START_OUT_ADD (0x00000000)	U	31 : 0	Additional length [# clock cycles] for active start signal. Active start signal length = 1+START_OUT_ADD
	0x12	Reserved. Set to 0x00000000			
	0x13	START_DELAY (0x00000000)	U	31 : 0	Delay time [# clock cycles] between start trigger and internal start signal release.
	0x14	CLK_GATING_DELAY (0x00000000)	U	31 : 0	Delay time [# clock cycles] between trigger and initialization of an active clock gating.
	0x15	STDBY_DELAY (0x00000000)	U	31 : 0	Delay time [# clock cycles] after a ramp end before activating the standby phase.
	0x16	FREEWHEEL_DELAY (0x00000000)	U	31 : 0	Delay time [# clock cycles] between initialization of an active standby phase and freewheeling initialization.
	0x17	VDRV_SCALE_LIMIT (0x00000000)	U	23 : 0	Drive scaling limit: <i>DRV2_SCALE_VAL</i> is active if <i>VACTUAL > VDRV_SCALE_LIMIT</i> , else <i>DRV1_SCALE</i>
		PWM_VMAX (0x00000000)			PWM: velocity value at which the scaled PWM value reaches the maximum scale parameter 1.
	0x18	UP_SCALE_DELAY (0x000000)	U	23 : 0	Increment delay [# clock cycles]. The value defines the clock cycles which are used to increase the current scale value for one step towards higher values.
		CL_UPSCALE_DELAY (0x000000)			Increment delay [# clock cycles]. The value defines the clock cycles which are used to increase the current scale value for one step towards higher current values during closed loop operation
	0x19	HOLD_SCALE_DELAY (0x000000)	U	23 : 0	Decrement delay [# clock cycles] to decrease the actual scale value by one step towards hold current.
		CL_DOWNSCALE_DELAY (0x000000)			Decrement delay [# clock cycles] to decrease the current scale value by one step towards lower current values during closed loop operation.
	0x1A	DRV_SCALE_DELAY (0x000000)	U	23 : 0	Decrement delay [# clock cycles] to decrease the current scale value by one step towards lower value.
	0x1B	BOOST_TIME (0x00000000)	U	31 : 0	Time [# clk cycles] after a ramp start when boost scaling is active.
	0x1C	CL_BETA (0x0FF)		8 : 0	Maximum commutation angle for closed loop regulation. Set CL_BETA > 256 carefully (esp. if cl_vlimit_en = 1). Exactly 256 is recommended for best performance.
		CL_GAMMA (0xFF)		23 : 16	Maximum balancing angle to compensate back EMF at higher velocities during closed loop regulation.
	0x1D	DAC_ADDR_A (0x0000)	U	15 : 0	Fixed command/address which is sent via SPI output before sending CURRENTA_SPI values.
		DAC_ADDR_B (0x0000)		31 : 16	Fixed command/address which is sent via SPI output before sending current CURRENTB_SPI values.
	0x1E	HOME_SAFETY_MARGIN (0x0000)	U	15 : 0	HOME_REF polarity could be invalid within $X_{HOME} \pm HOME_SAFETY_MARGIN$.
	0x1F	PWM_FREQ (0x0280)	U	15 : 0	Number of clock cycles for one PWM period.
		CHOPSYNC_DIV (0x0280)		11 : 0	Chopper clock divider the chopper frequency f_{osc} : $f_{osc} = f_{clk}/CHOPSYNC_DIV$ with $96 \leq CHOPSYNC_DIV \leq 818$

17.16 Ramp Generator Registers

RAMP GENERATOR					
R/W	Addr	Reg name (default)	S/U	Bit	Description
RW	0x20	RAMPMODE (0x0)		2	<p><i>Ramp_mode</i></p> <p>1 <i>Positioning</i>: XTARGET is superior objective for velocity ramp. 0 <i>Velocity mode</i>: VMAX is superior objective for velocity ramp.</p>
				1 : 0	<p><i>Ramp_type</i></p> <p>00 <i>Hold mode</i>: VACTUAL follows only VMAX (rectangle velocity shape). 01 <i>Trapezoidal ramp</i>: consideration of ac- and deceleration values for generating VACTUAL, but no adaption of these values. 10 <i>S-shaped ramp</i>: consideration of all ramp values (incl. bow values) for generating VACTUAL.</p>
RW	0x21	XACTUAL (0x00000000)	S	31 : 0	Current internal motor position [pulses]: $-2^{31} \leq XACTUAL \leq 2^{31} - 1$
R	0x22	VACTUAL (0x00000000)	S	31 : 0	Current ramp generator velocity [pulses per second]: $1 \text{ pps} \leq VACTUAL \leq CLK_FREQ \cdot \frac{1}{2} \text{ pulses}$ ($f_{CLK} = 16 \text{ MHz} : 8 \text{ Mpps}$)
R	0x23	AACTUAL (0x00000000)	S	31 : 0	Current acceleration/deceleration value [pulses per sec ²]: $1 \text{ pps}^2 \leq AACTUAL $ and $-2^{31} \text{ pps}^2 \leq AACTUAL \leq 2^{31} - 1$
RW	0x24	VMAX (0x00000000)	S	31 : 0	Maximum ramp generator velocity in <i>positioning mode</i> . Target ramp generator velocity in <i>velocity mode</i> and <i>hold mode</i> . Value representation: 23 digits and 8 decimal places $4 \text{ mpps} \leq VMAX \text{ [pps]} \leq CLK_FREQ \cdot \frac{1}{2} \text{ pulses}$ $f_{CLK} = 16 \text{ MHz} \rightarrow VMAX \leq 8 \text{ Mpps}$
RW	0x25	VSTART (0x00000000)	U	30 : 0	Absolute start velocity in <i>positioning mode</i> and <i>velocity mode</i> Value representation: 23 digits and 8 decimal places. <i>Positioning mode</i> : If VACTUAL = 0 and XTARGET ≠ XACTUAL: no acceleration phase for VACTUAL = 0 → VSTART. <i>Velocity mode</i> : If VACTUAL = 0 and VACTUAL ≠ VMAX: no acceleration phase for VACTUAL = 0 → VSTART. If VSTART ≠ 0 → no first bow phase B ₁ for S-shaped ramps
RW	0x26	VSTOP (0x00000000)	U	30 : 0	Absolute stop velocity in <i>positioning mode</i> and in <i>velocity mode</i> . Value representation: 23 digits and 8 decimal places. <i>Positioning mode</i> : If VACTUAL ≤ VSTOP and XTARGET = XACTUAL: VACTUAL will be set to 0 immediately. <i>Velocity mode</i> : If VACTUAL ≤ VSTOP and VMAX = 0: VACTUAL will be set to 0 immediately. If VSTOP ≠ 0 → no last bow phase B ₄ for S-shaped ramps If VSTOP is very small and <i>positioning mode</i> is used → eventually long period at the end of ramp with VACTUAL = VSTOP to reach XTARGET.
RW	0x27	VBREAK (0x00000000)	U	30 : 0	Absolute break velocity in <i>positioning mode</i> and in <i>velocity mode</i> , but only for trapezoidal ramp types . Value representation: 23 digits and 8 decimal places. If $ VACTUAL < VBREAK \rightarrow AACTUAL = ASTART / DFINAL$ If $ VACTUAL \geq VBREAK \rightarrow AACTUAL = AMAX / DMAX$ If VBREAK = 0 → pure linear ramps (AMAX / DMAX only). Set always VBREAK > VSTOP!

RAMP GENERATOR					
R/W	Addr	Reg name (default)	S/U	Bit	Description
RW	0x28	AMAX (0x000000)	U	23 : 0	<p><u>S-shaped ramp types</u>: Maximum acceleration value. <u>Trapezoidal ramps types</u>: Acceleration value if $VACTUAL \geq VBREAK$ or if $VBREAK = 0$.</p> <p><u>frequency mode</u>: [pulses per sec²] Value representation: 22 digits and 2 decimal places $250 \text{ mpps}^2 \leq AMAX \leq 4 \text{ Mpps}^2$ <u>direct mode</u>: Δv per clk cycle: $a[\Delta v \text{ per clk_cycle}] = AMAX / 2^{37}$ $AMAX [\text{pps}^2] = AMAX / 2^{37} \cdot f_{CLK}^2 (\leq 31.25 \text{ Gpps}^2 \text{ at } f_{CLK} = 16 \text{ MHz})$</p>
RW	0x29	DMAX (0x000000)	U	23 : 0	<p><u>S-shaped ramp types</u>: Maximum deceleration value. <u>Trapezoidal ramps types</u>: Deceleration value if $VACTUAL \geq VBREAK$ or if $VBREAK = 0$.</p> <p><u>frequency mode</u>: [pulses per sec²] Value representation: 22 digits and 2 decimal places $250 \text{ mpps}^2 \leq DMAX \leq 4 \text{ Mpps}^2$ <u>direct mode</u>: Δv per clk cycle: $a[\Delta v \text{ per clk_cycle}] = DMAX / 2^{37}$ $DMAX [\text{pps}^2] = DMAX / 2^{37} \cdot f_{CLK}^2 (\leq 31.25 \text{ Gpps}^2 \text{ at } f_{CLK} = 16 \text{ MHz})$</p>
RW	0x2A	ASTART (0x000000)	U	23 : 0	<p><u>S-shaped ramp types</u>: Start acceleration value. <u>Trapezoidal ramps types</u>: Acceleration value if $VACTUAL < VBREAK$</p> <p><u>frequency mode</u>: [pulses per sec²] Value representation: 22 digits and 2 decimal places $250 \text{ mpps}^2 \leq ASTART \leq 4 \text{ Mpps}^2$ <u>direct mode</u>: Δv per clk cycle: $a[\Delta v \text{ per clk_cycle}] = ASTART / 2^{37}$ $ASTART [\text{pps}^2] = ASTART / 2^{37} \cdot f_{CLK}^2 (\leq 31.25 \text{ Gpps}^2 \text{ at } f_{CLK} = 16 \text{ MHz})$</p>
RW	0x2B	DFINAL (0x000000)	U	23 : 0	<p><u>S-shaped ramp types</u>: Stop deceleration value. <u>Trapezoidal ramps types</u>: Deceleration value if $VACTUAL < VBREAK$</p> <p><u>frequency mode</u>: [pulses per sec²] Value representation: 22 digits and 2 decimal places $250 \text{ mpps}^2 \leq DFINAL \leq 4 \text{ Mpps}^2$ <u>direct mode</u>: Δv per clk cycle: $a[\Delta v \text{ per clk_cycle}] = DFINAL / 2^{37}$ $DFINAL [\text{pps}^2] = DFINAL / 2^{37} \cdot f_{CLK}^2 (\leq 31.25 \text{ Gpps}^2 \text{ at } f_{CLK} = 16 \text{ MHz})$</p>
RW	0x2C	DSTOP (0x000000)	U	23 : 0	<p>Deceleration value for an automatic linear stop ramp to $VACTUAL = 0$. $DSTOP$ will be used with activated external stop switches (STOPL or STOPR) if $soft_stop_enable$ is set to 1 or with activated virtual stop switches and $virt_stop_mode$ is set to b'10.</p>
RW	0x2D	BOW1 (0x000000)	U	23 : 0	<p>Bow value 1 (first bow B_1 of the acceleration ramp) <u>frequency mode</u>: [pulses per sec³] Value representation: 24 digits and 0 decimal places $1 \text{ mpps}^3 \leq BOW1 \leq 16 \text{ Mpps}^3$ <u>direct mode</u>: Δa per clk cycle: $bow[\Delta a \text{ per clk_cycle}] = BOW1 / 2^{53}$ $BOW1 [\text{pps}^3] = BOW1 / 2^{53} \cdot f_{CLK}^3 (\leq 7.63 \text{ Tpps}^3 \text{ at } f_{CLK} = 16 \text{ MHz})$</p>
RW	0x2E	BOW2 (0x000000)	U	23 : 0	<p>Bow value 2 (second bow B_2 of the acceleration ramp) Vide BOW1 for value representation and conversion calculations.</p>
RW	0x2F	BOW3 (0x000000)	U	23 : 0	<p>Bow value 3 (first bow B_3 of the deceleration ramp) Vide BOW1 for value representation and conversion calculations.</p>
RW	0x30	BOW4 (0x000000)	U	23 : 0	<p>Bow value 4 (second bow B_4 of the deceleration ramp) Vide BOW1 for value representation and conversion calculations.</p>
RW	0x31	CLK_FREQ (0x0F42400)	U	24 : 0	<p>External clock frequency value f_{CLK} [Hz] with $4.2 \text{ MHz} \leq f_{CLK} \leq 32 \text{ MHz}$</p>

17.17 Target and Compare Registers

TARGET AND COMPARE REGISTERS					
R/W	Addr	Reg name (default) (0x00000000)	S/U	Bit	Description
RW	0x32	POS_COMP (0x00000000)	S	31 : 0	Compare position.
RW	0x33	VIRT_STOP_LEFT (0x00000000)	S	31 : 0	Virtual left stop.
RW	0x34	VIRT_STOP_RIGHT (0x00000000)	S	31 : 0	Virtual right stop.
R	0x35	X_HOME (0x00000000)	S	31 : 0	Current home position.
R	0x36	X_LATCH (0x00000000)	S	31 : 0	Storage position for certain triggers.
RW	0x37	X_TARGET (0x00000000)	S	31 : 0	Target motor position in positioning mode. <i>Set all other motion profile parameters before!</i>
RW	0x38	X_PIPE0 (0x00000000)	S	31 : 0	1 st XTARGET follow-up
RW	0x39	X_PIPE1 (0x00000000)	S	31 : 0	2 nd XTARGET follow-up
RW	0x3A	X_PIPE2 (0x00000000)	S	31 : 0	3 rd XTARGET follow-up
RW	0x3B	X_PIPE3 (0x00000000)	S	31 : 0	4 th XTARGET follow-up
RW	0x3C	X_PIPE4 (0x00000000)	S	31 : 0	5 th XTARGET follow-up
RW	0x3D	X_PIPE5 (0x00000000)	S	31 : 0	6 th XTARGET follow-up
RW	0x3E	X_PIPE6 (0x00000000)	S	31 : 0	7 th XTARGET follow-up
RW	0x3F	X_PIPE7 (0x00000000)	S	31 : 0	8 th XTARGET follow-up
-	0x40... 0x4D	- (0x00000000)	-	-	Reserved. Set to 0x00000000.

17.18 Freeze Register

The freeze register can only be written once after an active reset and before motion starts.

It is always readable.

FREEZE					
R/W	Addr	Reg name (default)	S/U	Bit	Description
RW	0x4E	DFREEZE (0x000000)	U	23 : 0	Deceleration value. If NFREEZE switches to low the parameter is used for an automatic linear ramp stop. Setting DFREEZE to 0 leads to an hard stop. Value representation: $[\Delta v \text{ per clk_cycle}]$ $a[\Delta v \text{ per clk_cycle}] = DFREEZE / 2^{37}$ $DFREEZE [\text{pps}^2] = DFREEZE / 2^{37} \cdot f_{\text{CLK}}^2 (\leq 31.25 \text{ Gpps}^2 \text{ at } f_{\text{CLK}} = 16 \text{ MHz})$
		IFREEZE (0x00)	U	31 : 24	Scaling value if NFREEZE is tied low. If IFREEZE=0, current active scaling value will be valid at FREEZED event.

17.19 Clock Gating Enable Register

CLOCK GATING					
R/W	Addr	Reg name (default)	Bit	Description	
RW	0x4F	CLK_GATING_REG (0x0)		2 : 0	Setting all bits to 1 and VACTUAL = 0 initializes the clock gating countdown. If sleep state is active, this register is set to 0 and also the internal clock remains at low level (sleep state).

17.20 Encoder Registers

ENCODER REGISTERS					
R/W	Addr	Reg name (default)	S/U	Bit	Description
RW	0x50	<i>ENC_POS</i> (0x00000000)	S	31 : 0	Current encoder position [μ steps].
R	0x51	<i>ENC_LATCH</i> (0x00000000)	S	31 : 0	Latched encoder position.
R	0x52	<i>ENC_POS_DEV</i> (0x00000000)	S	31 : 0	Deviation between <i>XACTUAL</i> and <i>ENC_POS</i> .
W	0x53	<i>ENC_POS_DEV_TOL</i> (0xFFFFFFFF)	U	31 : 0	Tolerated value of $ X_ACTUAL - ENC_POS $.
W	0x54	<i>ENC_IN_RES</i> (0x00000000)	U	31 : 0	Resolution [encoder steps per revolution] of the encoder connected to the encoder inputs.
R		<i>ENC_CONST</i> (0x00000000)			Calculated encoder constant. Value representation: 16 digits and 16 decimal places
W	0x55	<i>ENC_OUT_RES</i> (0x00000000)	U	31 : 0	Resolution [encoder steps per revolution] of the serial encoder output interface.
W	0x56	<i>SER_CLK_IN_HIGH</i> (0x00A0)	U	15 : 0	High voltage level time of serial clock output [# clock cycles]
		<i>SER_CLK_IN_LOW</i> (0x00A0)		31 : 16	High voltage level time of serial clock output [# clock cycles]
W	0x57	<i>SSI_IN_CLK_DELAY</i> (0x0000)	U	15 : 0	<u>SSI encoder</u> : Delay time [# clock cycles] between next data transfer after a rising edge of serial clock output (if set to 0 \rightarrow <i>SSI_IN_CLK_DELAY</i> = <i>SER_CLK_IN_HIGH</i>) <u>SPI encoder</u> : Delay [# clock cycles] at start and end of data transfer between serial clock output & negated chip select. (if set to 0 \rightarrow <i>SSI_IN_CLK_DELAY</i> = <i>SER_CLK_IN_HIGH</i>)
		<i>BISS_TIMEOUT</i> (0x0000)			Reserved for BiSS encoder
		<i>SSI_IN_WTIME</i> (0x0F0)		25 : 16	Delay parameter <i>tw</i> [# clock cycles] between two clock sequences for a multiple data transfer (of the same data). SSI recommendation: <i>tw</i> < 19 μs.
		<i>BISS_IN_BUSYS</i> (0x0F0)			Reserved for BiSS encoder
W	0x58	<i>SSI_IN_PTIME</i> (0x00190)	U	19 : 0	<u>SSI and SPI encoder</u> : Delay time period <i>tp</i> [# clock cycles] between two consecutive clock sequences for new data request. SSI recommendation: <i>tp</i> > 21 μs.
		<i>BISS_IN_BUSYR</i> (0x00190)			Reserved for BiSS encoder
		<i>CRC_GEN_POLYNOM</i> (0x00)		31 : 24	CRC generator polynomial.

17.21 PID and Closed Loop Registers

PID / CLOSED LOOP					
R/W	Addr	Reg name (default)	S/U	Bit	Description
RW	0x59	CL_OFFSET (0x00000000)	S	31 : 0	Offset between ENC_POS and XACTUAL during closed loop calibration.
W	0x5A	PID_P (0x000000)	U	23 : 0	PID mode: parameter P of PID regulator. Update frequency = $f_{CLK}/128$
		CL_VMAX_CALC_P (0x000000)			ClosedLoop mode: Proportional term = $PID_E \cdot PID_P / 256$ Parameter P of PI regulator which controls maximum velocity during closed loop regulation.
R		PID_VEL (0x00000000)	S	31 : 0	Current PID output velocity.
W	0x5B	PID_I (0x000000)	U	23 : 0	PID mode: parameter I of PID regulator. Integral term = $PID_ISUM / 256 \cdot PID_I / 256$
		CL_VMAX_CALC_I (0x000000)			ClosedLoop mode: Parameter I of PI regulator which controls maximum velocity during closed loop regulation.
R		PID_ISUM_RD (0x00000000)	S	31 : 0	Current PID integrator sum. Update frequency = $f_{CLK}/128$
W	0x5C	PID_D (0x000000)	U	23 : 0	PID mode: Parameter D of PID regulator. PID_E is sampled with $f_{CLK} / 128 / PID_D_CLKDIV$. Derivative term = $(PID_E_{LAST} - PID_E_{ACTUAL}) \cdot PID_D$
		CL_DELTA_P (0x000000)			ClosedLoop mode: Gain parameter which is multiplied with the current position difference to calculate the current commutation angle for higher stiffness for position maintenance. Clipped at CL_BETA. Value representation: 8 digits and 16 decimal places Real value = $CL_DELTA_P / 2^{16}$ Example: 65536 = factor of 1 (no gain)
W	0x5D	PID_I_CLIP (0x0000)	U	14 : 0	PID and PI velocity regulator for ClosedLoop mode: Clipping parameter for PID_ISUM. Real value = $PID_ISUM \cdot 2^{16} \cdot PID_ICLIP$
		PID_D_CLKDIV (0x00)		23 : 16	PID and PI velocity regulator for ClosedLoop mode: Clock divider for D part calculation.
R		PID_E (0x00000000)	S	31 : 0	Current position deviation. Signed value.
W	0x5E	PID_DV_CLIP (0x00000000)	U	30 : 0	PID and PI velocity regulator for ClosedLoop mode: Clipping parameter for PID_VEL.
W	0x5F	PID_TOLERANCE (0x000000)	U	19 : 0	PID mode: Tolerated position deviation: $PID_E = 0$ if $ PID_E < PID_TOLERANCE$
		CL_TOLERANCE (0x00)		7 : 0	ClosedLoop mode: Tolerated position deviation: $CL_DELTA_P = 65536$ (Gain=1) if $ ENC_POS_DEV < CL_TOLERANCE$

17.22 Misc Registers

Closed loop operation is internally processed using a 256 microstep resolution. It is possible to use any encoder resolution since it is scaled to 256 microsteps.

Closed loop it is not possible with a Step/Dir input resolution of less than 256 microsteps!

MISC					
R/W	Addr	Reg name (default)	S/U	Bit	Description
W	0x60	FS_VEL (0x000000)	U	23 : 0	Minimum fullstep velocity [pps]. If VACTUAL > FS_VEL fullstep operation is possible.
		CL_VMIN_EMF (0x000000)			Encoder velocity at which back EMF consideration starts during closed loop operation.
W	0x61	CL_VADD_EMF (0x000000)	U	23 : 0	Additional velocity value to calculate V_MAX_CL_EMF which is the encoder velocity where back EMF consideration reaches the maximum angle CL_GAMMA during closed loop operation.
W	0x62	ENC_VEL_ZERO (0xFFFFF)	U	23 : 0	Delay time [# clock cycles] after the last incremental encoder change to set V_ENC_MEAN = 0.
W	0x63	ENC_VMEAN_WAIT (0x00)	U	7 : 0	Delay period [# clock cycles] before the next current encoder velocity value becomes considered for mean encoder velocity calculation.
		ENC_VMEAN_FILTER (0x0)		11 : 8	Filter exponent to calculate mean encoder velocity.
		ENC_VMEAN_INT (0x0000)		31 : 16	Filter update time [# clock cycles] Minimum value for valid V_ENC_MEAN data = 256
-	0x64	Reserved. Set to 0x00000000.			
R	0x65	V_ENC (0x00000000)	S	31 : 0	Current encoder velocity [pps].
R	0x66	V_ENC_MEAN (0x00000000)	S	31 : 0	Current filtered encoder velocity [pps].
W	0x67	VSTALL_LIMIT (0x00000000)	S	23 : 0	Stop on stall velocity limit [pps]: Only above this limit an active stall leads to a stop on stall if enabled.

17.23 Transfer Registers

TRANSFER					
R/W	Addr	Reg name (default)	S/U	Bit	Description
W	0x68	ADDR_TO_ENC (0x00000000)	-	31 : 0	<u>SPI encoder only:</u> Address data permanently sent to get encoder angle data from the SPI encoder slave device. <u>SPI encoder:</u> Address data sent from TMC4361 to the encoder for one-time data transfer.
W	0x69	DATA_TO_ENC (0x00000000)	-	31 : 0	SPI configuration data sent from TMC4361 to the serial encoder for one-time data transfer.
R	0x6A	ADDR_FROM_ENC (0x00000000)	-	31 : 0	<u>SPI encoder only:</u> Repeated request data is stored here. <u>SPI encoder:</u> SPI address data received from the serial encoder as response of the one-time data transfer.
R	0x6B	DATA_FROM_ENC (0x00000000)	-	31 : 0	SPI data received from the serial encoder as response of the one-time data transfer.
W	0x6C	COVER_LOW (0x00000000)	-	31 : 0	Lower configuration bits of SPI orders which should be sent from TMC4361 to the motor drivers via SPI output.
W	0x6D	COVER_HIGH (0x00000000)	-	31 : 0	Upper configuration bits of SPI orders which should be sent from TMC4361 to the motor drivers via SPI output.
R	0x6E	COVER_DRV_LOW (0x00000000)	-	31 : 0	Lower configuration bits of SPI response received from the motor driver connected to the SPI output.
R	0x6F	COVER_DRV_HIGH (0x00000000)	-	31 : 0	Upper configuration bits of SPI response received from the motor driver connected to the SPI output.

17.24 SinLUT Registers

SINLUT					
R/W	Addr	Reg name (default)	S/U	Bit	Description
W	0x70	MSLUT[0] (0xAAAAB554)	-	31 : 0	Each bit defines the difference between consecutive values in the microstep look-up table MSLUT (in combination with MSLUTSEL).
	0x71	MSLUT[1] (0x4A9554AA)			
	0x72	MSLUT[2] (0x24492929)			
	0x73	MSLUT[3] (0x10104222)			
	0x74	MSLUT[4] (0xFBFFFFFF)			
	0x75	MSLUT[5] (0xB5BB777D)			
	0x76	MSLUT[6] (0x49295556)			
	0x77	MSLUT[7] (0x00404222)			
W	0x78	MSLUTSEL (0xFFFF8056)	-	31 : 0	Definition of the four segments within each quarter MSLUT wave.
R	0x79	MSCNT (0x00000000)	U	9 : 0	Current μ Step position of the sine value.
R	0x7A	CURRENTA (0x000)	S	8 : 0	Actual current value of coilA (sine values).
		CURRENTB (0x000)	S	24 : 16	Actual current value of coilB (sine _{90_120} values).
R	0x7B	CURRENTA_SPI (0x000)	S	8 : 0	Actual current value of coilA (sine values).
		CURRENTB_SPI (0x000)	S	24 : 16	Actual current value of coilB (sine _{90_120} values).
R	0x7C	SCALE_PARAM (0x000)	U	8 : 0	Actual used scale parameter.
W	0x7D	ENC_COMP_XOFFSET (0x0000)	U	15 : 0	Maximum amplitude for encoder compensation
		ENC_COMP_YOFFSET (0x00)	S	23 : 16	Start offset for triangular compensation in vertical direction.
		ENC_COMP_AMPL (0x00)	U	31 : 24	Start offset for triangular compensation in horizontal direction (as number between 0 and 1).
W	0x7E	START_SIN (0x00)	U	7 : 0	Start value for sine waveform
		START_SIN _{90_120} (0xF7)	U	23 : 16	Start value for cosine waveform
		DAC_OFFSET (0x00)	U	31 : 24	Offset for absolute sine and cosine values which will be forwarded via SPI output as DAC output values.

18 Absolute Maximum Ratings

The maximum ratings may not be exceeded under any circumstances. Operating the circuit at or near more than one maximum rating at a time for extended periods shall be avoided by application design.

Parameter	Symbol	Min	Max	Unit
Supply voltage IO	V_{IO}	-0.3	5.25	V
Input voltage ($V_{DD} = 3.3V / 5V$)	V_{IN}	-0.3	3.6 / 5.5	V

19 Electrical Characteristics

19.1 DC Characteristics Operating Conditions

DC characteristics contain the spread of values guaranteed within the specified supply voltage range unless otherwise specified. Typical values represent the average value of all parts measured at +25°C. Temperature variation also causes stray to some values. A device with typical values will not leave Min/Max range within the full temperature range.

Parameter	Symbol	Conditions	Min	Typ	Max	Unit
Commercial temperature range	T_{COM}		-40		125	°C
Nominal core voltage	V_{DD}			1.8		V
Nominal IO voltage	V_{DD}			3.3 / 5.0		V
Nominal input voltage	V_{IN}		0.0		3.3 / 5.0	V
Input voltage low level	V_{INL}	$V_{DD} = 3.3V / 5V$	-0.3		0.8 / 1.2	V
Input voltage high level	V_{INH}	$V_{DD} = 3.3V / 5V$	2.3 / 3.5		3.6 / 5.5	V
Input with pull-down		$V_{IN} = V_{DD}$	5	30	110	μA
Input with pull-up		$V_{IN} = 0V$	-110	-30	-5	μA
Input low current		$V_{IN} = 0V$	-10		10	μA
Input high current		$V_{IN} = V_{DD}$	-10		10	μA
Output voltage low level	V_{OUTL}	$V_{DD} = 3.3V / 5V$			0.4	V
Output voltage high level	V_{OUTH}	$V_{DD} = 3.3V / 5V$	2.64 / 4.0			V
Output driver strength	I_{OUT_DRV}	$V_{DD} = 3.3V / 5V$		4.0		mA

19.2 Power Dissipation

Parameter	Symbol	Conditions	Min	Typ	Max	Unit
Static power dissipation	PD_{STAT}	All inputs at VDD or GND $V_{DD} = 3.3V / 5V$		1.0 / 1.5		mW
Dynamic power dissipation	PD_{DYN}	All inputs at VDD or GND f_{CLK} variable $V_{DD} = 3.3V / 5V$		2.0 / 3.0		mW / MHz
Total power dissipation	PD	$f_{CLK} = 16$ MHz $V_{DD} = 3.3V / 5V$		33.0 / 49.5		mW

19.3 General IO Timing Parameters

Parameter	Symbol	Conditions	Min	Typ	Max	Unit
Operation frequency	f_{CLK}	$f_{\text{CLK}} = 1 / t_{\text{CLK}}$	4.2*)	16	32	MHz
Clock Period	t_{CLK}	Rising edge to rising edge	33.5	62.5		ns
Clock time low			16.5			ns
Clock time high			16.5			ns
CLK input signal rise time	$t_{\text{RISE_IN}}$	20 % to 80 %			20	ns
CLK input signal fall time	$t_{\text{FALL_IN}}$	80 % to 20 %			20	ns
Output signal rise time	$t_{\text{RISE_OUT}}$	20 % to 80 % load 32 pF		3.5		ns
Output signal fall time	$t_{\text{FALL_OUT}}$	80 % to 20 % load 32 pF		3.5		ns
Setup time for SPI input signals in synchronous design	t_{SU}	Relative to rising clk edge	5			ns
Hold time	t_{HD}	Relative to rising clk edge	5			ns

*) The lower limit for f_{CLK} refers to the limits of the internal unit conversion to physical units. The chip will also operate at lower frequencies.

20 Layout Example

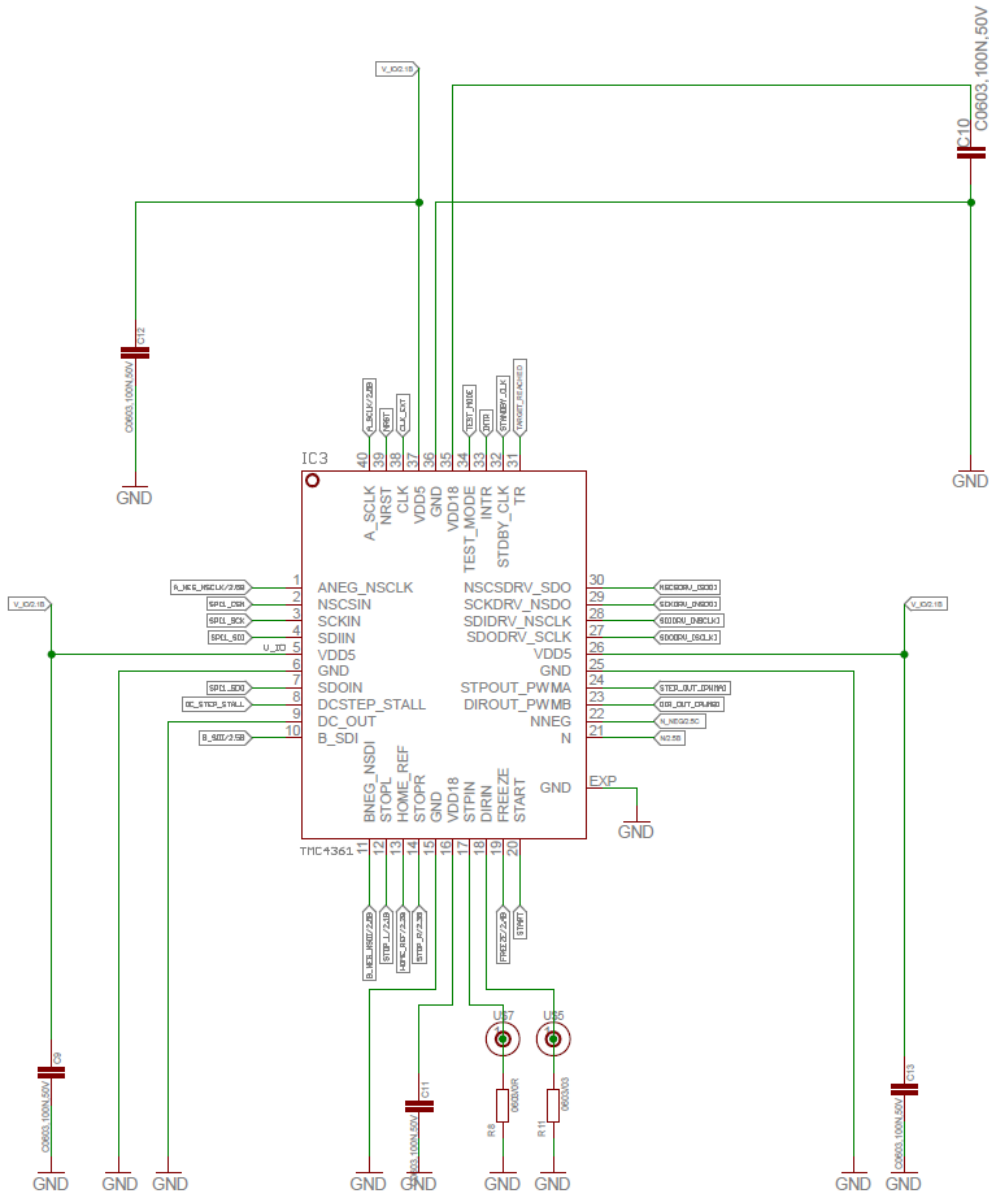

Figure 20.1 Internal circuit diagram for layout example

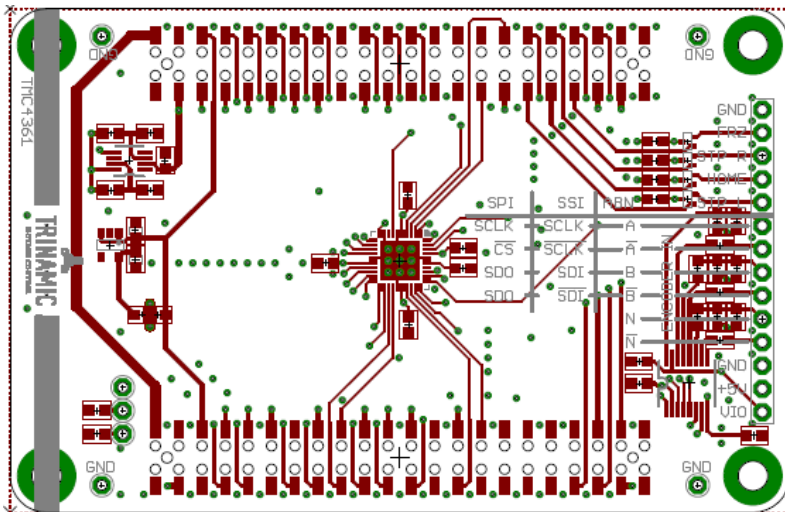

Figure 20.2 Components (assembly for application with encoder)

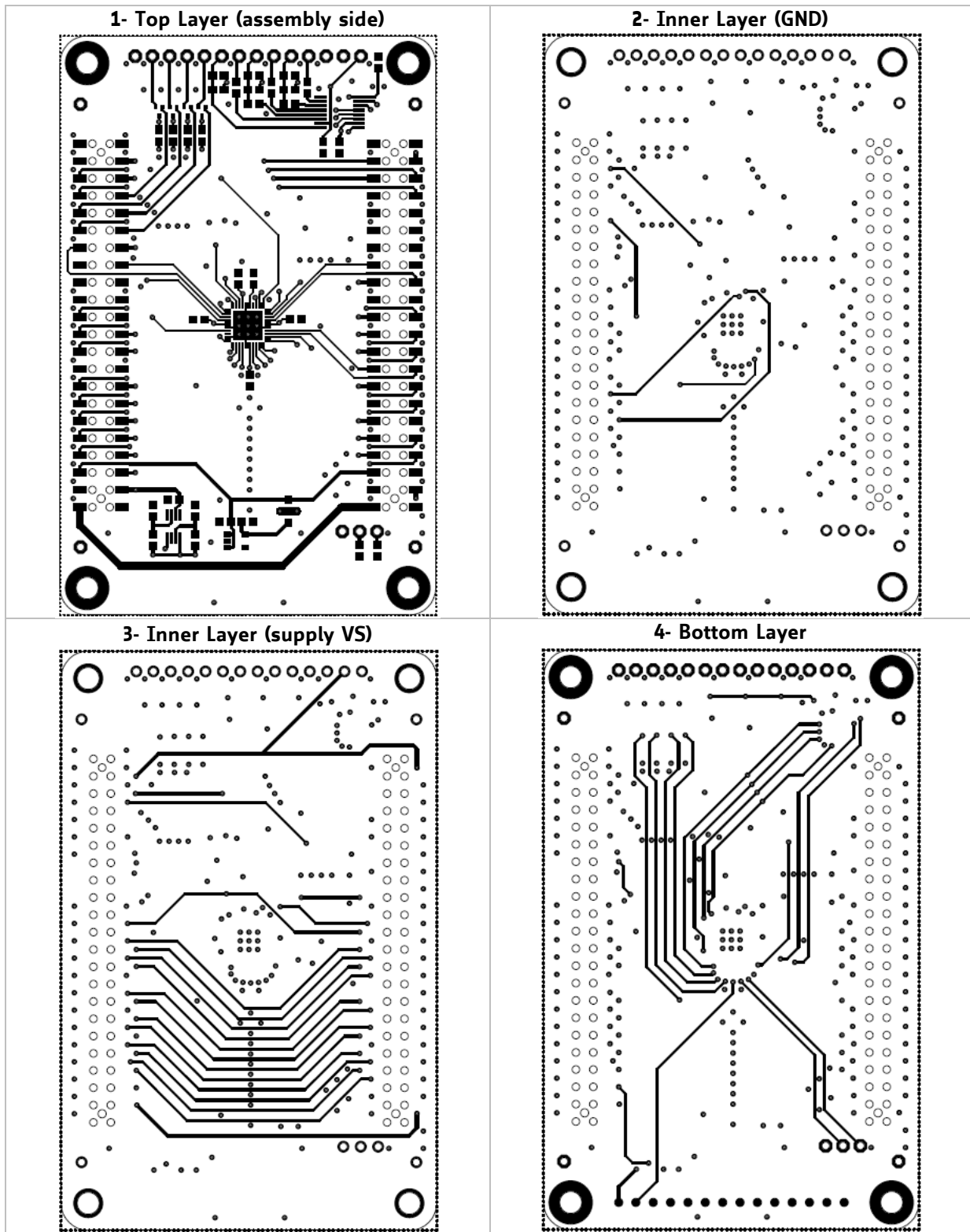

Figure 20.3 Layout example

21 Package Mechanical Data

21.1 Dimensional Drawings

Attention: Drawings not to scale. All values in millimeters.

Parameter	Ref	Min	Nom	Max
total thickness	A	0.8	0.85	0.9
stand off	A1	0	0.035	0.05
mold thickness	A2	-	0.65	0.67
lead frame thickness	A3	0.203 REF		
lead width	b	0.2	0.25	0.3
body size X	D	6 BSC		
body size Y	E	6 BSC		
lead pitch	e	0.5 BSC		
exposed die pad size X	J	4.52	4.62	4.72
exposed die pad size Y	K	4.52	4.62	4.72
lead length	L	0.35	0.4	0.45
package edge tolerance	aaa	0.1		
mold flatness	bbb	0.1		
coplanarity	ccc	0.08		
lead offset	ddd	0.1		
exposed pad offset	eee	0.1		

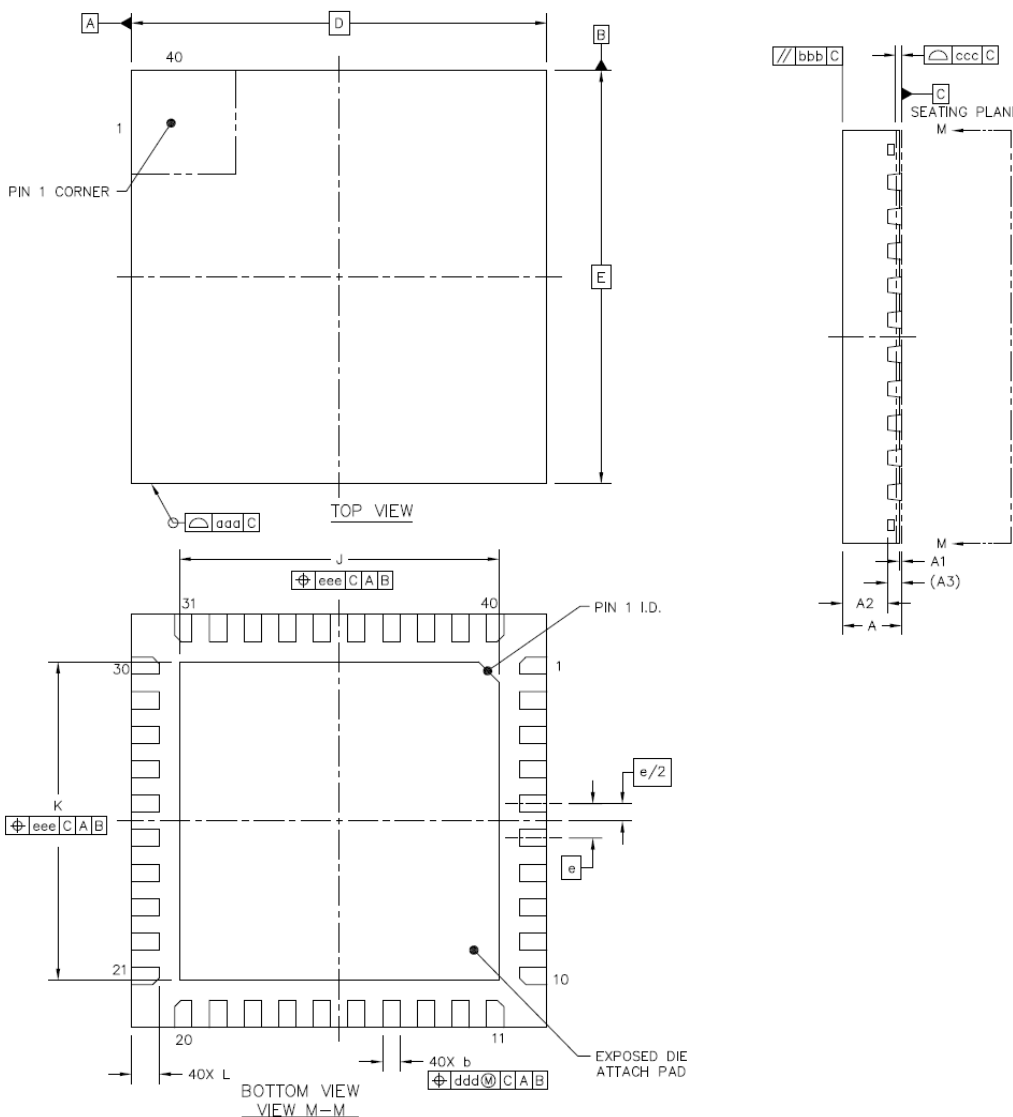

Figure 21.1 Dimensional drawings

21.2 Package Codes

Type	Package	Temperature range	Code & marking
TMC4361	QFN40 (RoHS)	-40°C ... +125°C	TMC4361-LA

22 Disclaimer

TRINAMIC Motion Control GmbH & Co. KG does not authorize or warrant any of its products for use in life support systems, without the specific written consent of TRINAMIC Motion Control GmbH & Co. KG. Life support systems are equipment intended to support or sustain life, and whose failure to perform, when properly used in accordance with instructions provided, can be reasonably expected to result in personal injury or death.

Information given in this data sheet is believed to be accurate and reliable. However no responsibility is assumed for the consequences of its use nor for any infringement of patents or other rights of third parties which may result from its use.

Specifications are subject to change without notice.

All trademarks used are property of their respective owners.

23 ESD Sensitive Device

The TMC4361 is an ESD sensitive CMOS device sensitive to electrostatic discharge. Take special care to use adequate grounding of personnel and machines in manual handling. After soldering the devices to the board, ESD requirements are more relaxed. Failure to do so can result in defect or decreased reliability.



24 Table of Figures

Figure 1.1 Basic application block diagram	4
Figure 1.2 Drive Concepts. M=Motor, E=Encoder	4
Figure 2.1 Pinning (top view).....	8
Figure 3.1 How to connect the TMC4361.....	10
Figure 3.2 TMC4361 with TMC248 stepper driver in SPI mode	10
Figure 3.3 TMC4361 with TMC26x stepper driver in Step/Dir mode. The SPI interface is used for configuration.....	11
Figure 5.1 SPI timing	14
Figure 6.1 Reference input pins: SR_REF = 1, FILT_L_REF = 1.....	16
Figure 6.2 START input pin: SR_S = 2, FILT_L_S = 0	16
Figure 6.3 Encoder interface input pins: SR_ENC_IN = 0, FILT_L_ENC_IN = 7	16
Figure 8.1 Rectangle shaped ramp type.....	20
Figure 8.2 Trapezoidal shaped ramp type	21
Figure 8.3 S-shaped ramp without initial and final acceleration/deceleration values.....	21
Figure 8.4 S-shaped ramp type with initial acceleration and final deceleration value for B1 and B4	21
Figure 8.5 Trapezoidal and S-shaped ramps using VSTART	22
Figure 8.6 Trapezoidal and S-shaped ramps using VSTOP	22
Figure 8.7 Trapezoidal and S-shaped ramps using VSTART and VSTOP	23
Figure 9.1 HOME_REF monitoring and HOME_ERROR_FLAG	28
Figure 10.1 Start example 1	31
Figure 10.2 Start example 2	31
Figure 10.3 Start example 3	32
Figure 10.4 Flexible target pipeline	33
Figure 11.1 LUT programming example.....	35
Figure 11.2 Wave showing segments with all possible base inclinations (highest inclination first).....	37
Figure 11.3 SPI output datagram timing (CDL – cover_data_length)	38
Figure 11.4 Cover data register composition (CDL – cover_data_length).....	39
Figure 11.5 Scaling: example 1	46
Figure 11.6 Scaling: example 2	46
Figure 13.1 Calculation of PWM duty cycles	48
Figure 14.1 Outline of ABN signals of an incremental encoder	51
Figure 14.2 SSI signals with SSI_IN_CLK_DELAY=SER_CLK_IN_HIGH when SSI_IN_CLK_DELAY=0.....	53
Figure 14.3 SSI signals with SSI_IN_CLK_DELAY for compensating processing time and long wires.....	53
Figure 14.4 Supported SPI encoder data transfer modes.....	55
Figure 14.5 Calculation of the output angle by setting CL_DELTA_P properly.....	58
Figure 14.6 Current scaling in with closed loop	59
Figure 14.7 Current scaling timing behavior	59
Figure 14.8 Calculation of the current load angle CL_GAMMA	60
Figure 14.9 Implemented triangular function to compensate for encoder misalignments	61
Figure 15.1 Example for SSI output configuration.....	62
Figure 16.1 Manual clock gating and manual wake up.....	63
Figure 16.2 Automatic clock gating	64
Figure 20.1 Internal circuit diagram for layout example	90
Figure 20.2 Components (assembly for application with encoder).....	90
Figure 20.3 Layout example	91
Figure 21.1 Dimensional drawings	92

25 Revision History

25.1 Document Revisions

Version	Date	Author HS = Hagen Sämrow SD = Sonja Dwersteg JP = Jonas P. Proeger	Description
1.00	2014-APR-11	HS, SD	First complete version.
1.01	2014-APR-28	SD	Cross reference in chapter 9.3 corrected. Internal ramp generator units corrected.
1.02	2014-MAY-19	SD	- Changes related to the design. - Connection scheme on page 2 changed.
1.03	2014-MAY-23	SD	Clock frequency range updated.
1.04	2014-DEC-11	JP	Changed Package suffix to -LA
1.05	2015-MAR-02	JP	Updated temperature ratings

Table 25.1 Document Revisions