

SPECIFICATIONS CSB63CG2Y2C

OUTLINES DIMENSIONS

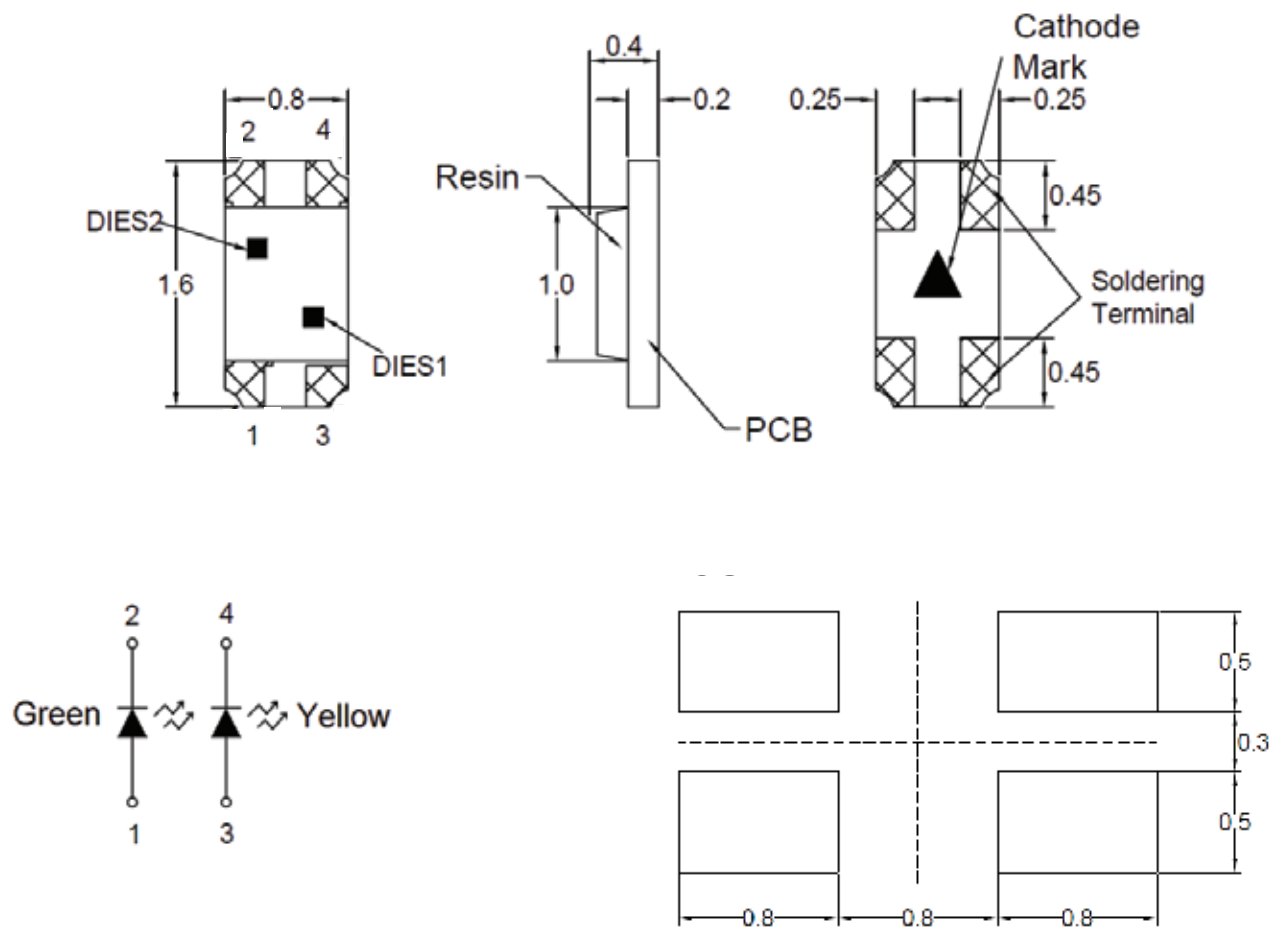

- Notes:
1. All Dimensions are in millimeters (inches).
 2. Tolerance is $\pm 0.25\text{mm}$ (0.01") unless otherwise noted.
 3. Specifications are subject to change without notice.

Part Number	Chip Material	Color of Emission	Lens Type	Viewing Angle
CSB63CG2Y2C	InGaAlP	Yellow/Green	Water Clear	130°



ChromeLED Corp. reserves the right to make changes at any time in order to supply the best product possible. The most current version of this document will always be available at: www.chromeled.com

ABSOLUTE MAXIMUM RATINGS
(TA=25°C)

Parameter	Symbol	Color	Max Rating	Unit
Power Dissipation	P _D	YELLOW	78	mW
		GREEN	78	
Pulse Current Forward Current	I _{FP}	YELLOW	60	mA
		GREEN	60	
Continuous Forward Current	I _F	YELLOW	30	mA
		GREEN		
Reverse Voltage	V _R	5		V
Operating Temperature Range	T _{OPR}	-40~+85		°C
Storage Temperature Range	T _{STG}	-40~+100		°C
I _{FP} = Pulse Width ≤ 10 ms, Duty Ratio ≤ 1/10. Soldering Condition: 260 °C/ 5sec				

OPTICAL-ELECTRICAL CHARACTERISTICS
(TA=25°C)

Parameter	Symbol	Test Condition	Color	Value			Unit
				Min	Typ	Max	
Luminous Intensity	I _v	I _F = 20mA	YELLOW	50	100	-	mcd
			Green	12.5	32	-	
Forward Voltage	V _F	I _F = 20mA	YELLOW	-	2.0	2.6	V
			Green	-	2.0	2.6	
Reverse Leakage Current	I _R	V _R = 5V	YELLOW	-	-	10	μA
			Green	-	-	10	
Viewing Angle	2θ _{1/2}	I _F = 20mA	YELLOW	-	130	-	deg
			Green	-	130	-	
Dominant Wavelength	λ _D	I _F = 20mA	YELLOW	-	595	-	nm
			Green	-	574	-	

*Tolerance of viewing angle: -10 / +5 deg.

 ChromeLED Corp. reserves the right to make changes at any time in order to supply the best product possible. The most current version of this document will always be available at: www.chromeled.com

OPTICAL CHARACTERISTIC CURVES (YELLOW)

Fig.1 Forward current vs. Forward Voltage

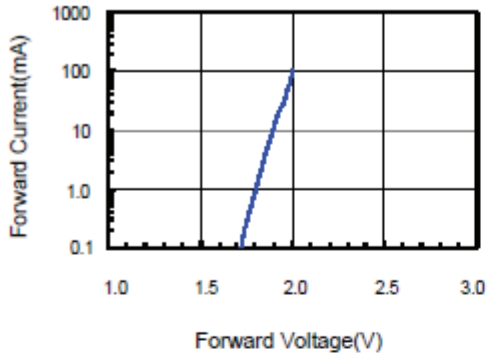

Fig.2 Relative Intensity vs. Forward Current

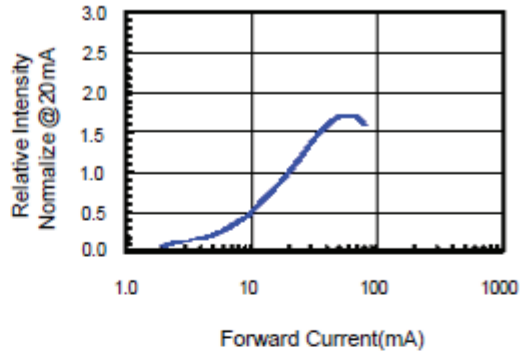

Fig.3 Forward Voltage vs. Temperature

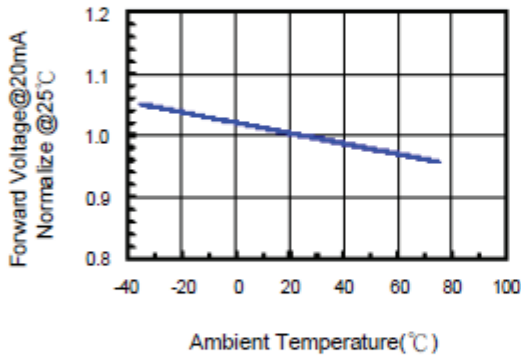

Fig.4 Relative Intensity vs. Temperature

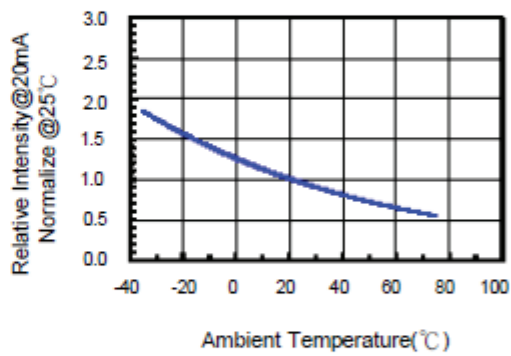

Fig.5 Relative Intensity vs. Wavelength

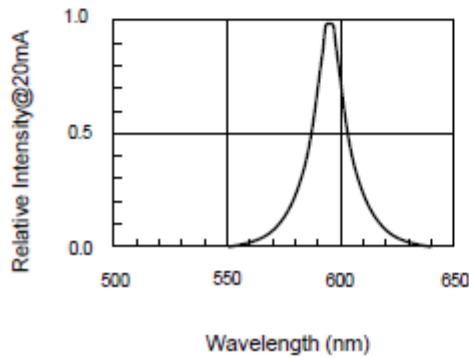
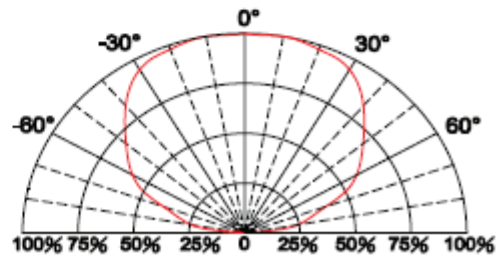

Fig.6 Directive Radiation



ChromeLED Corp. reserves the right to make changes at any time in order to supply the best product possible. The most current version of this document will always be available at: www.chromeled.com

OPTICAL CHARACTERISTIC CURVES (GREEN)

Fig.1 Forward current vs. Forward Voltage

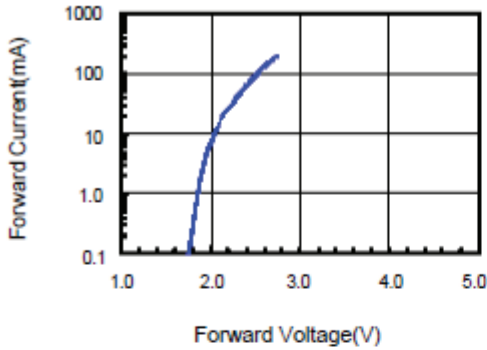

Fig.2 Relative Intensity vs. Forward Current

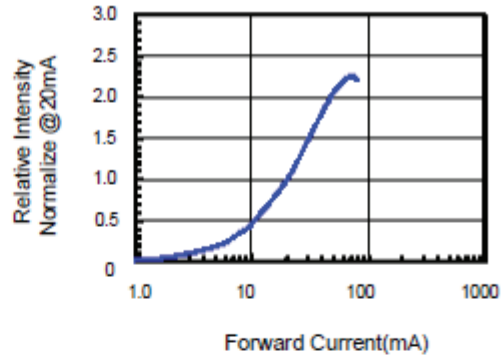

Fig.3 Forward Voltage vs. Temperature

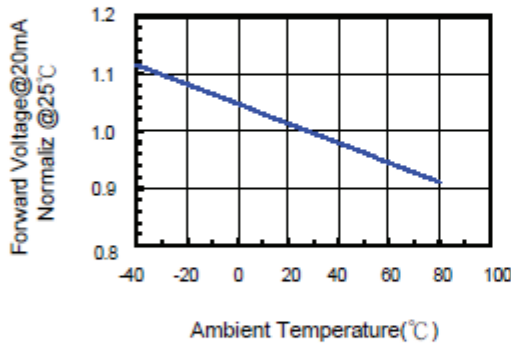

Fig.4 Relative Intensity vs. Temperature

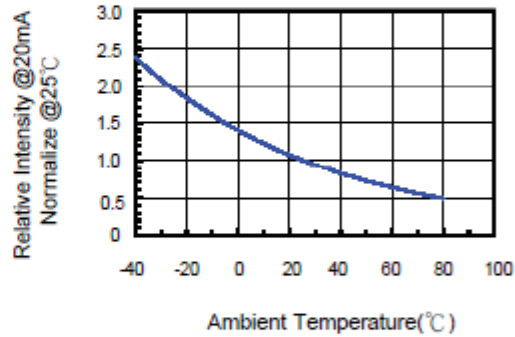

Fig.5 Relative Intensity vs. Wavelength

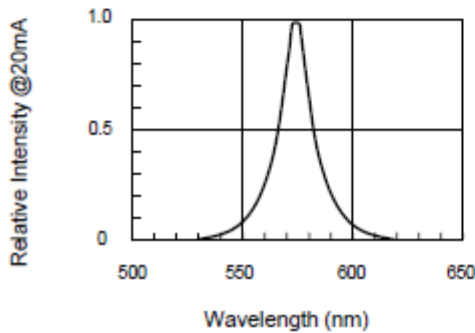
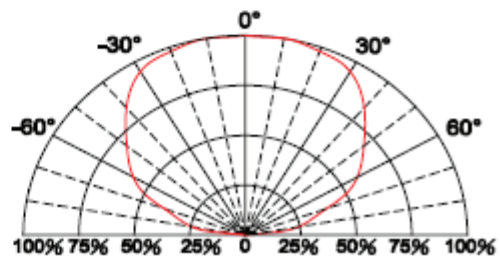

Fig.6 Directive Radiation



ChromeLED Corp. reserves the right to make changes at any time in order to supply the best product possible. The most current version of this document will always be available at: www.chromeled.com

SOLDERING CONDITIONS – LAMP TYPE LED

RECOMMENDED SOLDERING CONDITIONS

1. Hand Solder

Basic spec is $\leq 280^{\circ}\text{C}$ 3 sec one time only.

1. PB-Free Reflow Solder

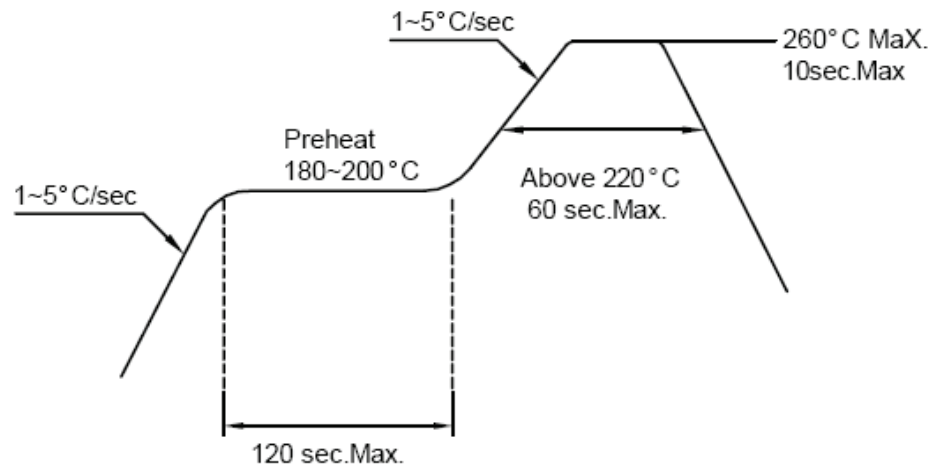

Notes:

1. Reflow soldering should not be done more than two times.
2. When soldering, do not put stress on the LEDs during heating.
3. After soldering, do not wrap the circuit board



ChromeLED Corp. reserves the right to make changes at any time in order to supply the best product possible. The most current version of this document will always be available at: www.chromeled.com

PACKAGING SPECIFICATIONS

CARRIER TAPE DIMENSION

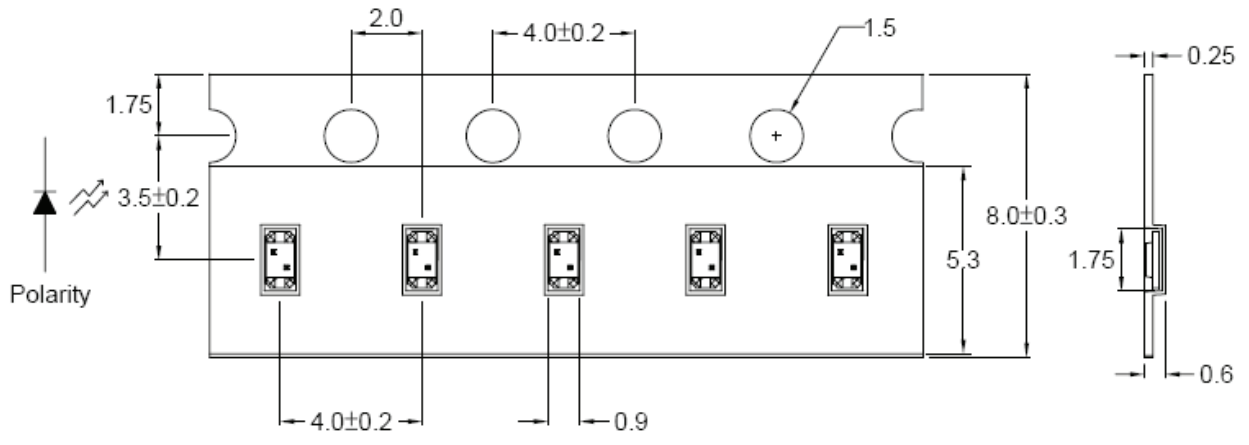

Note: The tolerances unless mentioned are ±0.1mm, Angle ±0.5; Unit=mm

REEL DIMENSIONS

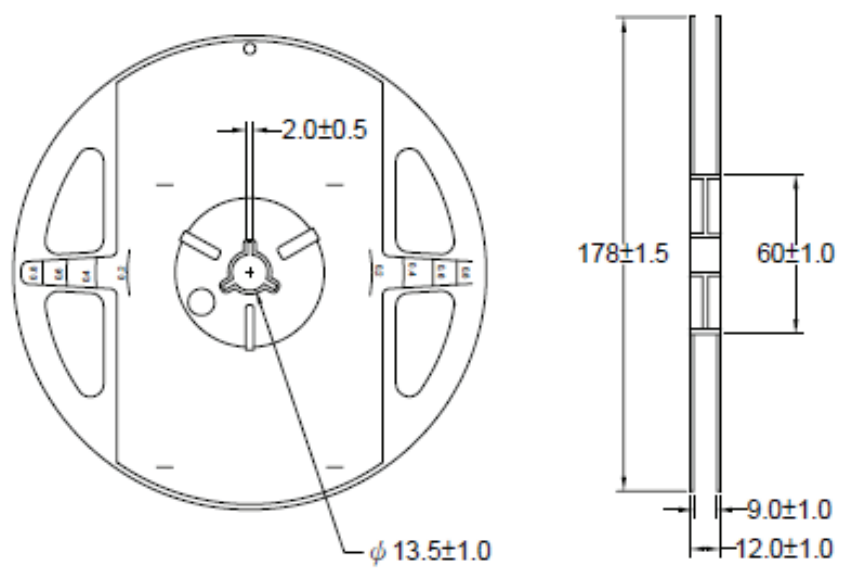

Note: 4000 pieces per reel.



ChromeLED Corp. reserves the right to make changes at any time in order to supply the best product possible. The most current version of this document will always be available at: www.chromeled.com