

# CM1443-04CP

## 4-Channel EMI Filter Array with ESD Protection

### Features

- Four Channels of EMI Filtering for Data Ports
- Pi-Style EMI Filters in a Capacitor-Resistor-Capacitor (C-R-C) Network
- $\pm 15$  kV ESD Protection on Each Channel (IEC 61000-4-2 Level 4, Contact Discharge)
- $\pm 30$  kV ESD Protection on Each Channel (HBM)
- Chip Scale Package (CSP) Features Extremely Low Lead Inductance for Optimum Filter and ESD Performance
- 10-Bump; 0.4 mm Pitch, 1.560 x 1.053 mm Footprint
- *OptiGuard*<sup>™</sup> Coating for Improved Reliability at Assembly
- These Devices are Pb-Free and are RoHS Compliant

### Applications

- EMI Filtering and ESD Protection for Both Data and I/O Ports
- Wireless Handsets
- Handheld PCs / PDAs
- MP3 Players
- Notebooks
- Desktop PCs

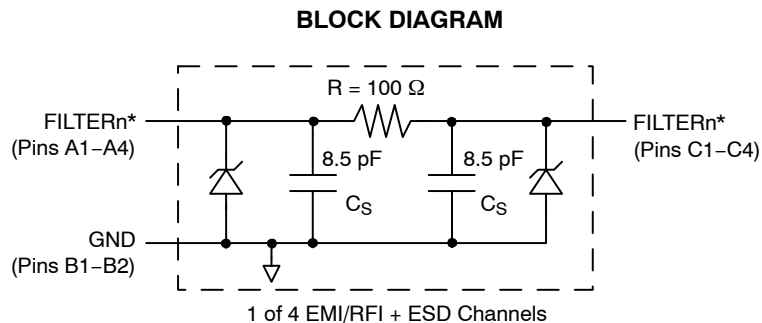

\*See Package/Pinout Diagrams for expanded pin information.



**ON Semiconductor**<sup>®</sup>

<http://onsemi.com>



**WLCSP10  
CP SUFFIX  
CASE 567BH**

### MARKING DIAGRAM

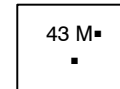

43 = CM1443-04CP  
M = Date Code  
▪ = Pb-Free Package  
(Note: Microdot may be in either location)

### ORDERING INFORMATION

Device	Package	Shipping <sup>†</sup>
CM1443-04CP	CSP-10 (Pb-Free)	3500/Tape & Reel

<sup>†</sup>For information on tape and reel specifications, including part orientation and tape sizes, please refer to our Tape and Reel Packaging Specification Brochure, BRD8011/D.

# CM1443-04CP

**Table 1. PIN DESCRIPTIONS**

10-bump CSP Package		
Pin(s)	Name	Description
A1	FILTER1	Filter Channel 1
A2	FILTER2	Filter Channel 2
A3	FILTER3	Filter Channel 3
A4	FILTER4	Filter Channel 4
B1-B2	GND	Device Ground
C1	FILTER1	Filter Channel 1
C2	FILTER2	Filter Channel 2
C3	FILTER3	Filter Channel 3
C4	FILTER4	Filter Channel 4

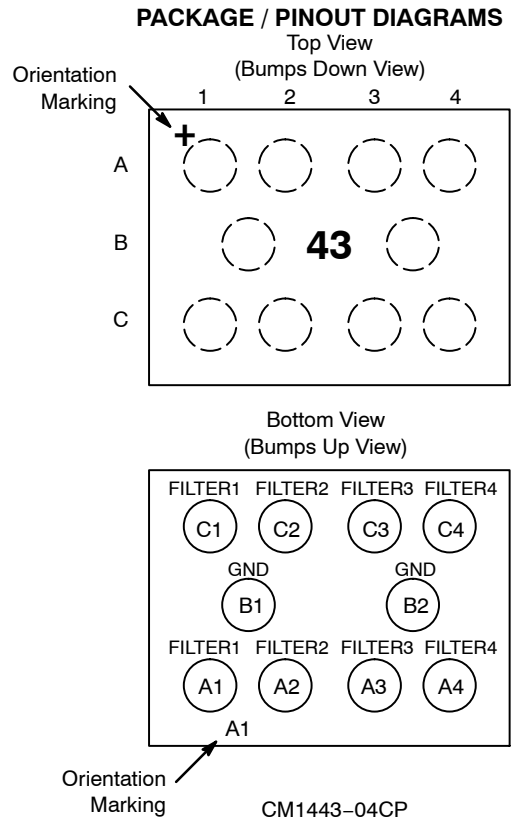

## SPECIFICATIONS

**Table 2. ABSOLUTE MAXIMUM RATINGS**

Parameter	Rating	Units
Storage Temperature Range	-65 to +150	°C
DC Power per Resistor	100	mW
DC Package Power Rating	600	mW

Stresses exceeding Maximum Ratings may damage the device. Maximum Ratings are stress ratings only. Functional operation above the Recommended Operating Conditions is not implied. Extended exposure to stresses above the Recommended Operating Conditions may affect device reliability.

**Table 3. STANDARD OPERATING CONDITIONS**

Parameter	Rating	Units
Operating Temperature Range	-40 to +85	°C

# CM1443-04CP

**Table 4. ELECTRICAL OPERATING CHARACTERISTICS** (Note 1)

Symbol	Parameter	Conditions	Min	Typ	Max	Units
R	Resistance		80	100	120	$\Omega$
C <sub>T</sub>	Total Capacitance	At 2.5 V DC	14	17	21	pF
C <sub>S</sub>	Single Capacitor	At 2.5 V DC		8.5		pF
V <sub>DIODE</sub>	Diode Voltage (reverse bias)	I <sub>DIODE</sub> = 10 $\mu$ A	5.5			V
I <sub>LEAK</sub>	Diode Leakage Current (reverse bias)	V <sub>DIODE</sub> = 3.3 V		0.1	1.0	$\mu$ A
V <sub>SIG</sub>	Signal Voltage Positive Clamp Negative Clamp	I <sub>LOAD</sub> = 10 mA	5.6 -0.4	6.8 -0.8	9.0 -1.5	V
V <sub>ESD</sub>	In-system ESD Withstand Voltage a) Human Body Model, MIL-STD-883, Method 3015 b) Contact Discharge per IEC 61000-4-2 Level 4	(Notes 2 and 4)	$\pm$ 30 $\pm$ 15			kV
V <sub>CL</sub>	Clamping Voltage during ESD Discharge MIL-STD-883 (Method 3015), 8 kV Positive Transients Negative Transients	(Notes 2, 3 and 4)		+10 -5		V
f <sub>C</sub>	Cut-off Frequency Z <sub>SOURCE</sub> = 50 $\Omega$ , Z <sub>LOAD</sub> = 50 $\Omega$	R = 100 $\Omega$ , C <sub>S</sub> = 8.5 pF		220		MHz

1. T<sub>A</sub> = 25°C unless otherwise specified.
2. ESD applied to input and output pins with respect to GND, one at a time.
3. Clamping voltage is measured at the opposite side of the EMI filter to the ESD pin. For example, if ESD is applied to Pin A1, then clamping voltage is measured at Pin C1.
4. Unused pins are left open.

## APPLICATION INFORMATION

Refer to Application Note “The Chip Scale Package”, for a detailed description of Chip Scale Packages offered by ON Semiconductor.

## PERFORMANCE INFORMATION

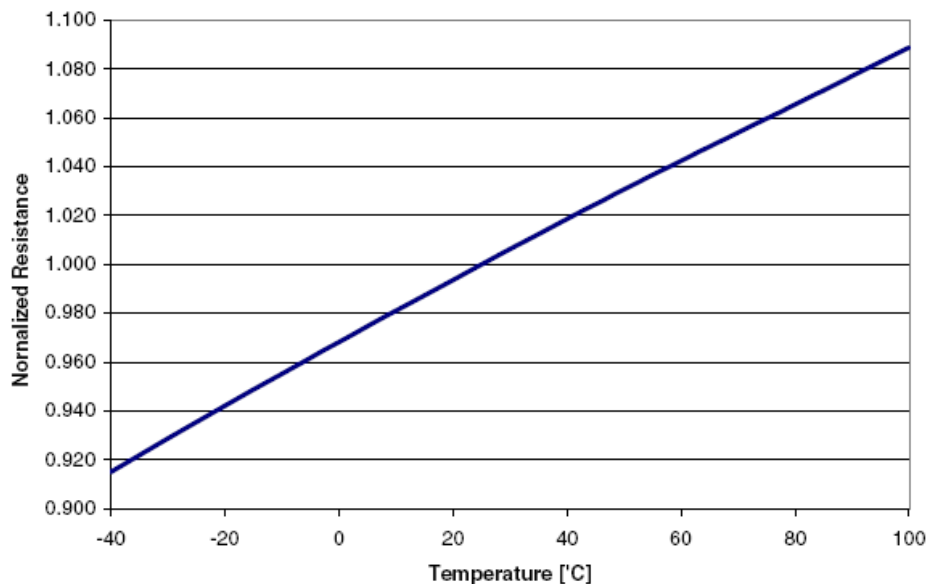

**Figure 1. Resistance vs. Temperature**  
(normalized to resistance at 25°C)

# CM1443-04CP

## PERFORMANCE INFORMATION (Cont'd)

Typical Filter Performance ( $T_A = 25^\circ\text{C}$ , DC Bias = 0 V, 50  $\Omega$  Environment)

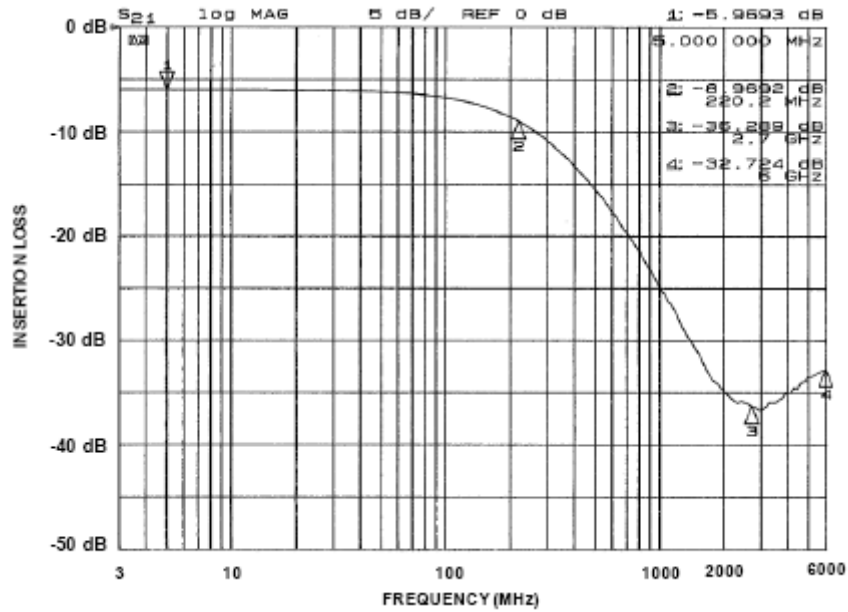

Figure 2. Insertion Loss vs. Frequency (A1-C1 to GND B1)

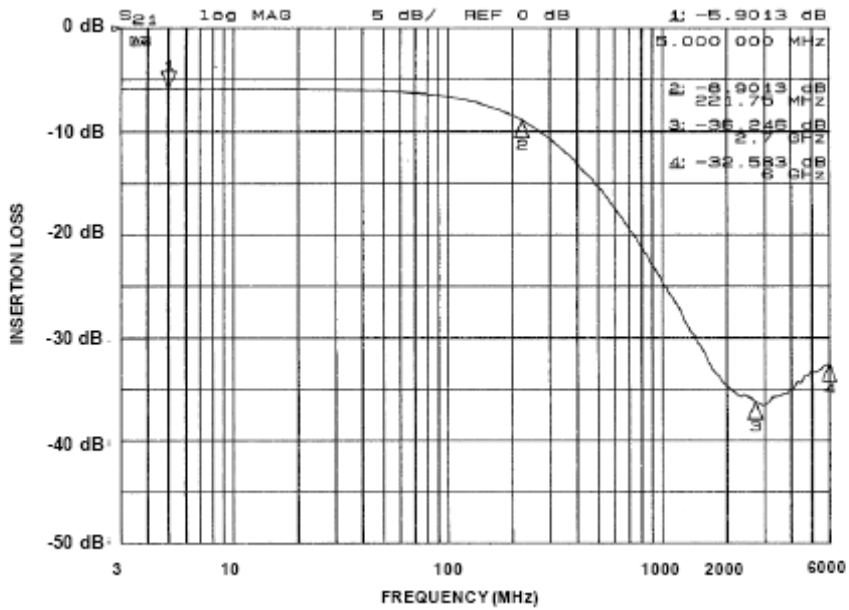

Figure 3. Insertion Loss vs. Frequency (A2-C2 to GND B1)

# CM1443-04CP

## PERFORMANCE INFORMATION (Cont'd)

Typical Filter Performance ( $T_A = 25^\circ\text{C}$ , DC Bias = 0 V, 50  $\Omega$  Environment)

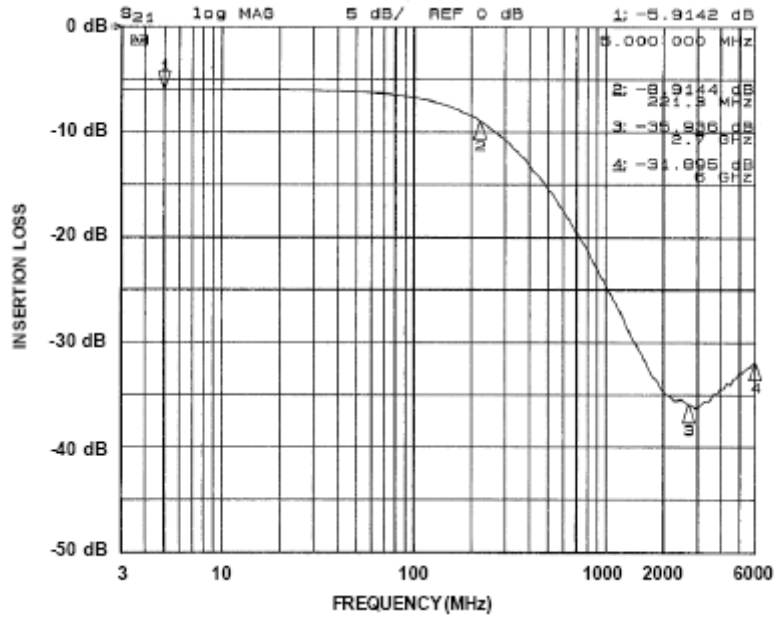

Figure 4. Insertion Loss vs. Frequency (A3-C3 to GND B2)

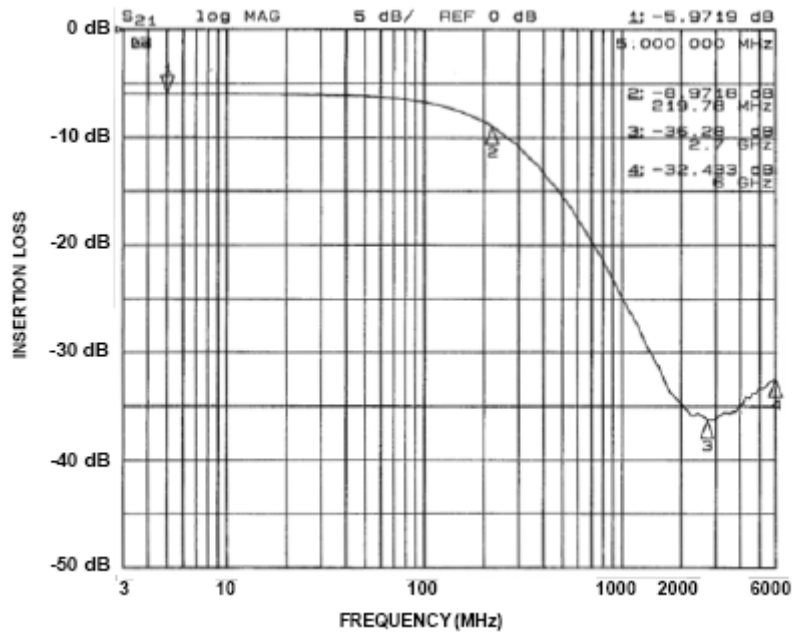

Figure 5. Insertion Loss vs. Frequency (A4-C4 to GND B2)

# CM1443-04CP

## PERFORMANCE INFORMATION (Cont'd)

Typical Filter Performance ( $T_A = 25^\circ\text{C}$ , DC Bias = 0 V, 50  $\Omega$  Environment)

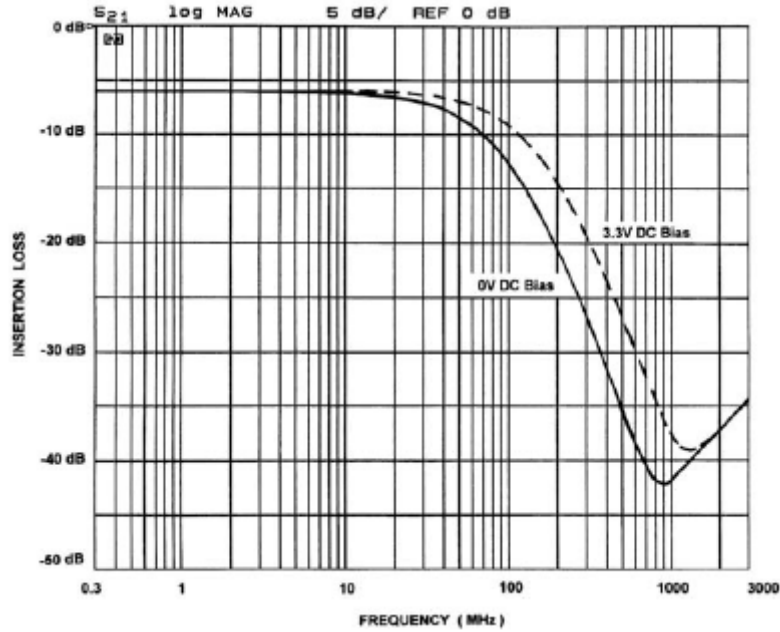

Figure 6. Comparison of Filter Response Curves for CM1443 vs. DC Bias

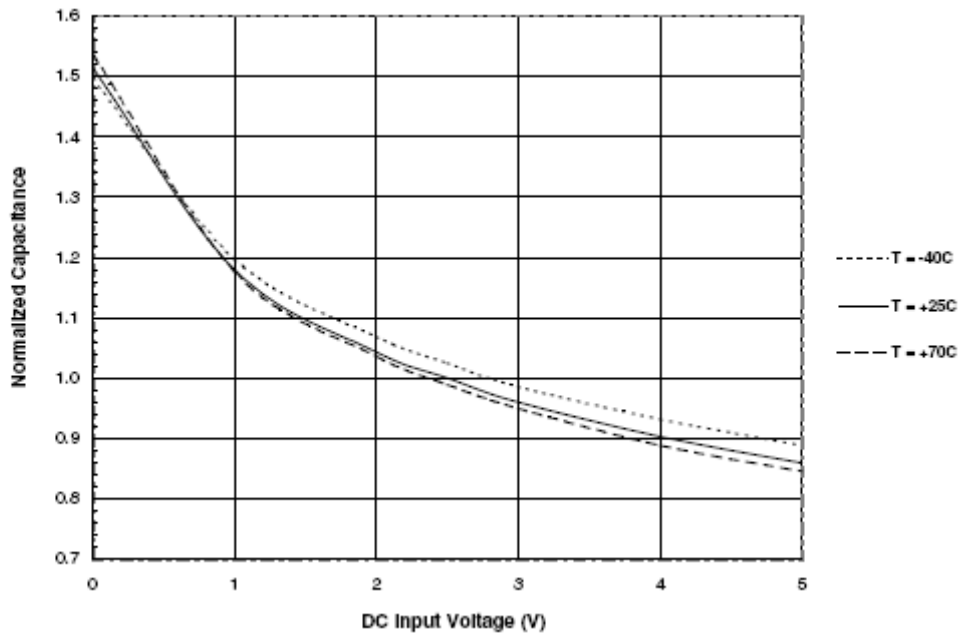

Figure 7. Filter Capacitance vs. Input Voltage over Temperature (normalized to capacitance at 2.5 VDC and  $25^\circ\text{C}$ )

# MECHANICAL CASE OUTLINE

## PACKAGE DIMENSIONS

ON Semiconductor®



SCALE 4:1

**WLCSP10, 1.56x1.05**  
CASE 567BH-01  
ISSUE O

DATE 26 JUL 2010

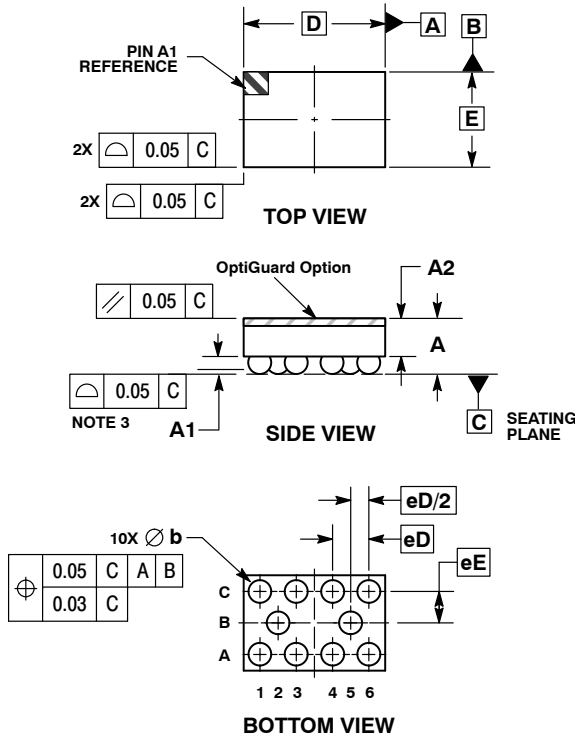

**NOTES:**

1. DIMENSIONING AND TOLERANCING PER ASME Y14.5M, 1994.
2. CONTROLLING DIMENSION: MILLIMETERS.
3. COPLANARITY APPLIES TO SPHERICAL CROWNS OF SOLDER BALLS.

DIM	MILLIMETERS	
	MIN	MAX
A	0.54	0.69
A1	0.17	0.24
A2	0.42	REF
b	0.24	0.29
D	1.56	BSC
E	1.05	BSC
eD	0.400	BSC
eE	0.347	BSC

**RECOMMENDED SOLDERING FOOTPRINT\***

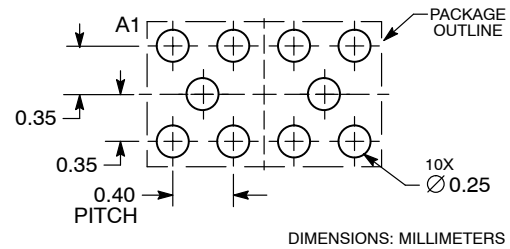

\*For additional information on our Pb-Free strategy and soldering details, please download the ON Semiconductor Soldering and Mounting Techniques Reference Manual, SOLDERRM/D.

<b>DOCUMENT NUMBER:</b>	<b>98AON49817E</b>	Electronic versions are uncontrolled except when accessed directly from the Document Repository. Printed versions are uncontrolled except when stamped "CONTROLLED COPY" in red.
<b>DESCRIPTION:</b>	<b>WLCSP10, 1.56X1.05</b>	<b>PAGE 1 OF 1</b>

ON Semiconductor and are trademarks of Semiconductor Components Industries, LLC dba ON Semiconductor or its subsidiaries in the United States and/or other countries. ON Semiconductor reserves the right to make changes without further notice to any products herein. ON Semiconductor makes no warranty, representation or guarantee regarding the suitability of its products for any particular purpose, nor does ON Semiconductor assume any liability arising out of the application or use of any product or circuit, and specifically disclaims any and all liability, including without limitation special, consequential or incidental damages. ON Semiconductor does not convey any license under its patent rights nor the rights of others.

ON Semiconductor and  are trademarks of Semiconductor Components Industries, LLC dba ON Semiconductor or its subsidiaries in the United States and/or other countries. ON Semiconductor owns the rights to a number of patents, trademarks, copyrights, trade secrets, and other intellectual property. A listing of ON Semiconductor's product/patent coverage may be accessed at [www.onsemi.com/site/pdf/Patent-Marking.pdf](http://www.onsemi.com/site/pdf/Patent-Marking.pdf). ON Semiconductor reserves the right to make changes without further notice to any products herein. ON Semiconductor makes no warranty, representation or guarantee regarding the suitability of its products for any particular purpose, nor does ON Semiconductor assume any liability arising out of the application or use of any product or circuit, and specifically disclaims any and all liability, including without limitation special, consequential or incidental damages. Buyer is responsible for its products and applications using ON Semiconductor products, including compliance with all laws, regulations and safety requirements or standards, regardless of any support or applications information provided by ON Semiconductor. "Typical" parameters which may be provided in ON Semiconductor data sheets and/or specifications can and do vary in different applications and actual performance may vary over time. All operating parameters, including "Typicals" must be validated for each customer application by customer's technical experts. ON Semiconductor does not convey any license under its patent rights nor the rights of others. ON Semiconductor products are not designed, intended, or authorized for use as a critical component in life support systems or any FDA Class 3 medical devices or medical devices with a same or similar classification in a foreign jurisdiction or any devices intended for implantation in the human body. Should Buyer purchase or use ON Semiconductor products for any such unintended or unauthorized application, Buyer shall indemnify and hold ON Semiconductor and its officers, employees, subsidiaries, affiliates, and distributors harmless against all claims, costs, damages, and expenses, and reasonable attorney fees arising out of, directly or indirectly, any claim of personal injury or death associated with such unintended or unauthorized use, even if such claim alleges that ON Semiconductor was negligent regarding the design or manufacture of the part. ON Semiconductor is an Equal Opportunity/Affirmative Action Employer. This literature is subject to all applicable copyright laws and is not for resale in any manner.

## PUBLICATION ORDERING INFORMATION

### LITERATURE FULFILLMENT:

Email Requests to: [orderlit@onsemi.com](mailto:orderlit@onsemi.com)

ON Semiconductor Website: [www.onsemi.com](http://www.onsemi.com)

### TECHNICAL SUPPORT

North American Technical Support:  
Voice Mail: 1 800-282-9855 Toll Free USA/Canada  
Phone: 011 421 33 790 2910

Europe, Middle East and Africa Technical Support:

Phone: 00421 33 790 2910

For additional information, please contact your local Sales Representative