



KPS-5130PD7C RGB Color Sensor

DESCRIPTION

- The KPS-5130PD7C Color Sensor Device, consisting of 3-Channel/1Chip (R, G, B) Si photodiode is a good effective solution to color balance of display backlighting appliances

FEATURES

- Lead-free package
- Component in accordance with RoHS
- SMD style package on PCB technology
- Integral Color Filter in Blue, Green, or Red
- Package: 1500 pcs / reel
- Moisture sensitivity level: 3
- RoHS Compliant

APPLICATIONS

The devices are suitable for :

- Colorimetry
- Printing process control
- Display color correction

PACKAGE DIMENSIONS

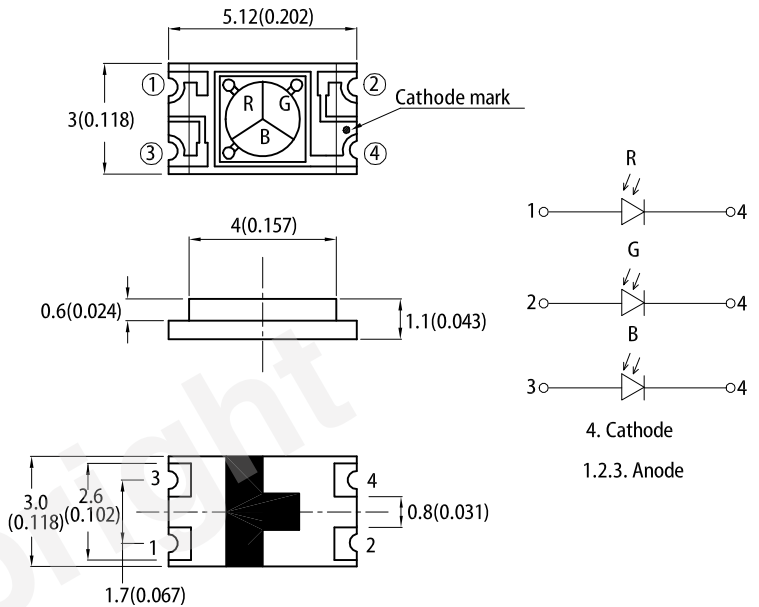

RECOMMENDED SOLDERING PATTERN

(units : mm; tolerance : ± 0.1)

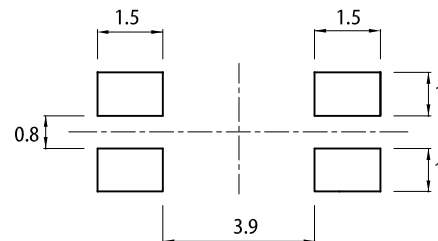

Notes:

- All dimensions are in millimeters (inches).
- Tolerance is $\pm 0.25(0.01)$ unless otherwise noted.
- The specifications, characteristics and technical data described in the datasheet are subject to change without prior notice.
- The device has a single mounting surface. The device must be mounted according to the specifications.

ABSOLUTE MAXIMUM RATINGS at $T_A=25^\circ\text{C}$ (UNLESS OTHERWISE SPECIFIED)

Parameter	Symbol	Value	Unit
Reverse Voltage	V_R	10	V
Operating Temperature	T_{opr}	-40 to +85	$^\circ\text{C}$
Storage Temperature	T_{stg}	-40 to +85	$^\circ\text{C}$
Soldering Temperature	T_{sd}	260	$^\circ\text{C}$

Note:
1. Relative humidity levels maintained between 40% and 60% in production area are recommended to avoid the build-up of static electricity – Ref JEDEC/JESD625-A and JEDEC/J-STD-033.

ELECTRICAL / OPTICAL CHARACTERISTICS at T_A=25°C (UNLESS OTHERWISE SPECIFIED)

Symbol	Parameter	Condition	Value			Unit	
			Min.	Typ.	Max.		
I _{L1}	Light Current (1)	100Lux ^[1] V _R = 5V	Red	-	0.039	-	μA
			Green	-	0.042	-	
			Blue	-	0.022	-	
I _{L2}	Light Current (2)	1000Lux ^[1] V _R = 5V	Red	-	0.427	-	μA
			Green	-	0.498	-	
			Blue	-	0.262	-	
D	Diameter of the irradiation sensitive area		-	2.0	-	mm	
A	Irradiation sensitive area per element		-	0.85	-	mm ²	
S _{Max}	Photo sensibility of the single color areas	λ _R = 620 nm λ _G = 550 nm λ _B = 470 nm	-	0.33 0.25 0.18	-	A/W	
I _D	Reverse Dark Current	V _R = 5V	-	-	10	nA	
λ _{0.1}	Range of spectral bandwidth	Red	570	-	670	nm	
		Green	450	-	650		
		Blue	370	-	530		
λ _p	Wavelength of peak sensitivity	Red	-	620	-	nm	
		Green	-	550	-		
		Blue	-	470	-		
2θ _{1/2}	Angle of half sensitivity		-	120	-	deg	

Notes:

- White fluorescent light (Color Temperature = 6500K) is used as light source.
- Excess driving current and / or operating temperature higher than recommended conditions may result in severe light degradation or premature failure.

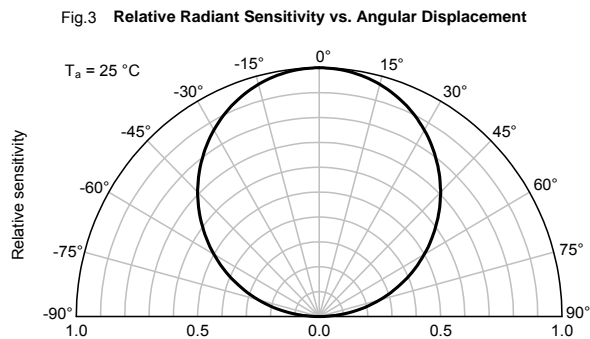
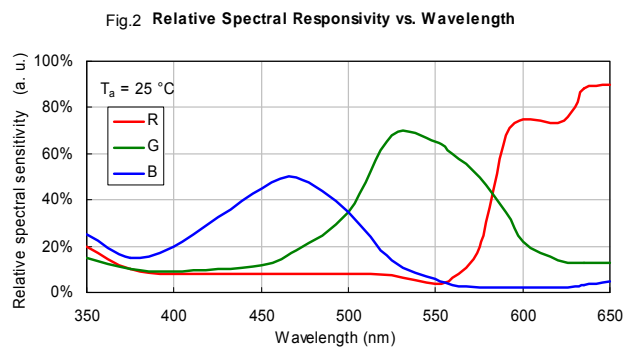
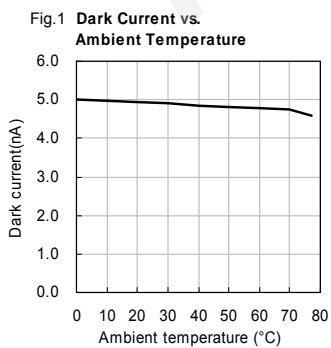

TYPICAL ELECTRO - OPTICAL CHARACTERISTICS CURVES

Fig.4 R,G,B LED Test vs. Output Photocurrent

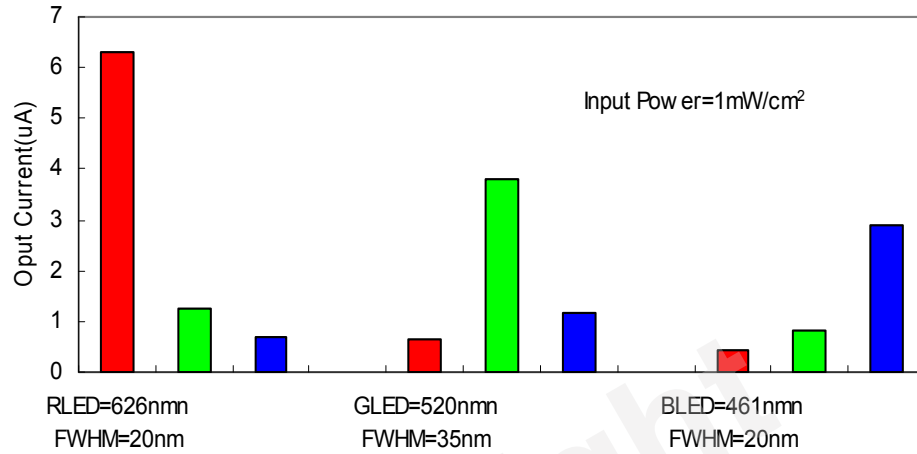
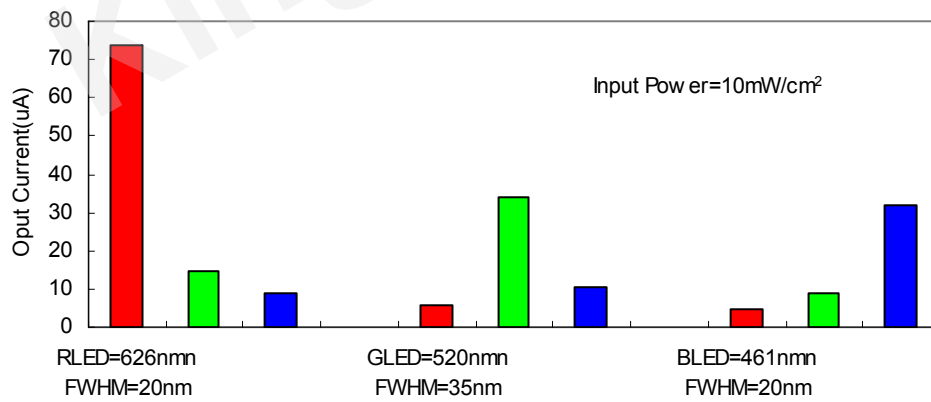
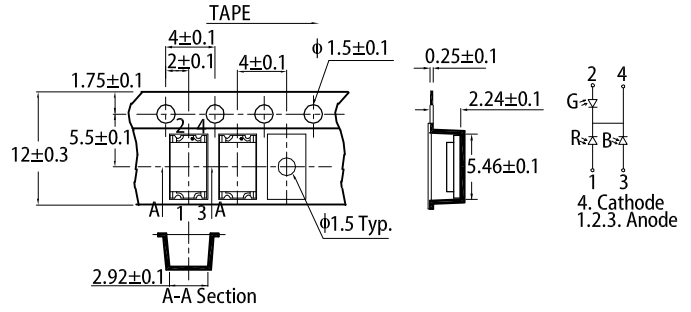
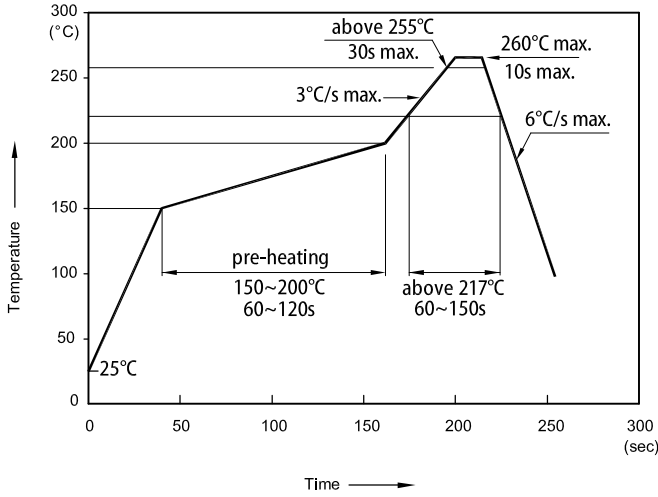

Fig.5 R,G,B LED Test vs. Output Photocurrent



REFLOW SOLDERING PROFILE for LEAD-FREE SMD PROCESS

TAPE SPECIFICATIONS (units : mm)



- Notes:
1. Don't cause stress to the LEDs while it is exposed to high temperature.
 2. The maximum number of reflow soldering passes is 2 times.
 3. Reflow soldering is recommended. Other soldering methods are not recommended as they might cause damage to the product.

PACKING & LABEL SPECIFICATIONS

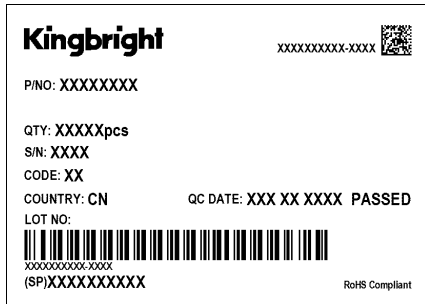
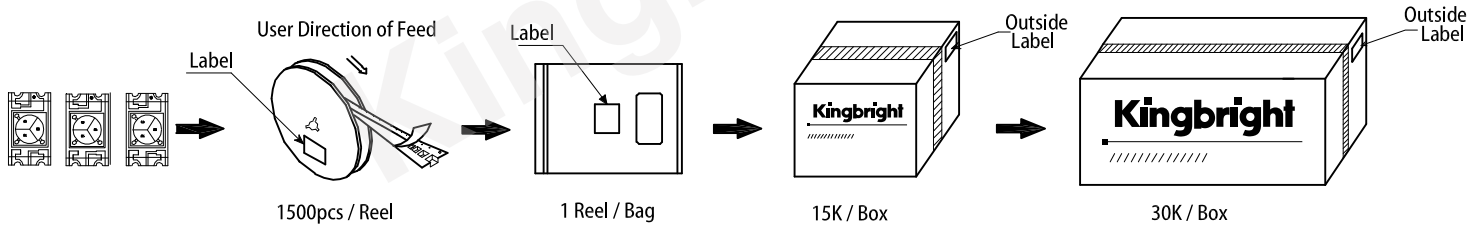

PRECAUTIONARY NOTES

1. The information included in this document reflects representative usage scenarios and is intended for technical reference only.
2. The part number, type, and specifications mentioned in this document are subject to future change and improvement without notice. Before production usage customer should refer to the latest datasheet for the updated specifications.
3. When using the products referenced in this document, please make sure the product is being operated within the environmental and electrical limits specified in the datasheet. If customer usage exceeds the specified limits, Kingbright will not be responsible for any subsequent issues.
4. The information in this document applies to typical usage in consumer electronics applications. If customer's application has special reliability requirements or have life-threatening liabilities, such as automotive or medical usage, please consult with Kingbright representative for further assistance.
5. The contents and information of this document may not be reproduced or re-transmitted without permission by Kingbright.
6. All design applications should refer to Kingbright application notes available at https://www.Kingbright.com/application_notes