

Features

- Low gate charge
- 100% avalanche tested
- Improved dv/dt capability
- RoHS compliant
- Halogen free package
- JEDEC Qualification

$V_{DSS} = 880 \text{ V} @ T_{jmax}$

$I_D = 9.5A$

$R_{DS(ON)} = 1.05 \Omega(\text{max}) @ V_{GS} = 10 \text{ V}$

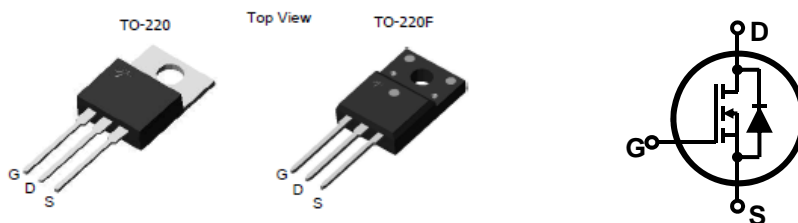

Device	Package	Marking	Remark
GP1M010A080H	TO-220	GP1M010A080H	RoHS
GP1M010A080FH	TO-220F	GP1M010A080FH	Halogen Free

Absolute Maximum Ratings

Parameter	Symbol	GP1M010A080H	GP1M010A080FH	Unit	
Drain-Source Voltage	V_{DSS}	800		V	
Gate-Source Voltage	V_{GS}	±30		V	
Continuous Drain Current	I_D	$T_C = 25 \text{ }^\circ\text{C}$	9.5	9.5 *	A
		$T_C = 100 \text{ }^\circ\text{C}$	6.4	6.4 *	A
Pulsed Drain Current (Note 1)	I_{DM}	38	38*	A	
Single Pulse Avalanche Energy (Note 2)	E_{AS}	917		mJ	
Repetitive Avalanche Current (Note 1)	I_{AR}	9.5		A	
Repetitive Avalanche Energy (Note 1)	E_{AR}	29		mJ	
Power Dissipation	P_D	$T_C = 25 \text{ }^\circ\text{C}$	290	48	W
		Derate above 25 °C	2.32	0.38	W/°C
Peak Diode Recovery dv/dt (Note 3)	dv/dt	4.5		V/ns	
Operating Junction and Storage Temperature Range	T_J, T_{STG}	-55~150		°C	
Maximum lead temperature for soldering purposes, 1/8" from case for 5 seconds	T_L	300		°C	

* Limited only by maximum junction temperature

Thermal Characteristics

Parameter	Symbol	GP1M010A080H	GP1M010A080FH	Unit
Maximum Thermal resistance, Junction-to-Case	$R_{\theta JC}$	0.43	2.6	°C/W
Maximum Thermal resistance, Junction-to-Ambient	$R_{\theta JA}$	62.5	62.5	°C/W

Electrical Characteristics : $T_C=25^\circ\text{C}$, unless otherwise noted

Parameter	Symbol	Test condition	Min	Typ	Max	Units
OFF						
Drain-Source Breakdown Voltage	BV_{DSS}	$V_{GS} = 0\text{ V}, I_D = 250\ \mu\text{A}$	800	--	--	V
Zero Gate Voltage Drain Current	I_{DSS}	$V_{DS} = 800\text{ V}, V_{GS} = 0\text{ V}$	--	--	10	μA
		$V_{DS} = 640\text{ V}, T_C = 125^\circ\text{C}$	--	--	100	μA
Forward Gate-Source Leakage Current	I_{GSSF}	$V_{GS} = 30\text{ V}, V_{DS} = 0\text{ V}$	--	--	100	nA
Reverse Gate-Source Leakage Current	I_{GSSR}	$V_{GS} = -30\text{ V}, V_{DS} = 0\text{ V}$	--	--	-100	nA
ON						
Gate Threshold Voltage	$V_{GS(th)}$	$V_{DS} = V_{GS}, I_D = 250\ \mu\text{A}$	2	--	4	V
Drain-Source On-Resistance	$R_{DS(on)}$	$V_{GS} = 10\text{ V}, I_D = 4.75\text{ A}$	--	0.9	1.05	Ω
Forward Transconductance ^(Note 4)	g_{FS}	$V_{DS} = 30\text{ V}, I_D = 4.75\text{ A}$	--	6.3	--	S
DYNAMIC						
Input Capacitance	C_{iss}	$V_{DS} = 25\text{ V}, V_{GS} = 0\text{ V},$ $f = 1.0\text{ MHz}$	--	2336	--	pF
Output Capacitance	C_{oss}		--	214	--	pF
Reverse Transfer Capacitance	C_{rss}		--	29	--	pF
SWITCHING						
Turn-On Delay Time ^(Note 4,5)	$t_{d(on)}$	$V_{DD} = 400\text{ V}, I_D = 9.5\text{ A},$ $R_G = 25\ \Omega$	--	63	--	ns
Turn-On Rise Time ^(Note 4,5)	t_r		--	62	--	ns
Turn-Off Delay Time ^(Note 4,5)	$t_{d(off)}$		--	256	--	ns
Turn-Off Fall Time ^(Note 4,5)	t_f		--	72	--	ns
Total Gate Charge ^(Note 4,5)	Q_g	$V_{DS} = 640\text{ V}, I_D = 9.5\text{ A},$ $V_{GS} = 10\text{ V}$	--	53	--	nC
Gate-Source Charge ^(Note 4,5)	Q_{gs}		--	10	--	nC
Gate-Drain Charge ^(Note 4,5)	Q_{gd}		--	22.3	--	nC
SOURCE DRAIN DIODE						
Maximum Continuous Drain-Source Diode Forward Current	I_S	---	--	--	9.5	A
Maximum Pulsed Drain-Source Diode Forward Current	I_{SM}	---	--	--	38	A
Drain-Source Diode Forward Voltage	V_{SD}	$V_{GS} = 0\text{ V}, I_S = 9.5\text{ A}$	--	--	1.5	V
Reverse Recovery Time ^(Note 4)	t_{rr}	$V_{GS} = 0\text{ V}, I_S = 9.5\text{ A}$ $di_F / dt = 100\text{ A}/\mu\text{s}$	--	453	--	ns
Reverse Recovery Charge ^(Note 4)	Q_{rr}		--	5.3	--	μC

Note :

1. Repeated rating : Pulse width limited by safe operating area
2. $L=17.2\text{mH}, I_{AS} = 9.5\text{A}, V_{DD} = 50\text{V}, R_G = 25\Omega,$ Starting $T_J = 25^\circ\text{C}$
3. $I_{SD} \leq 9.5\text{A}, di/dt \leq 200\text{A}/\mu\text{s}, V_{DD} \leq BV_{DS},$ Starting $T_J = 25^\circ\text{C}$
4. Pulse Test : Pulse width $\leq 300\mu\text{s},$ Duty Cycle $\leq 2\%$
5. Essentially Independent of Operating Temperature Typical Characteristics

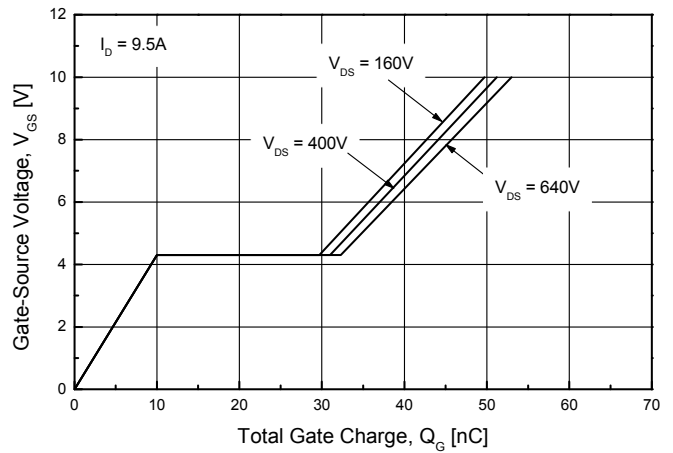
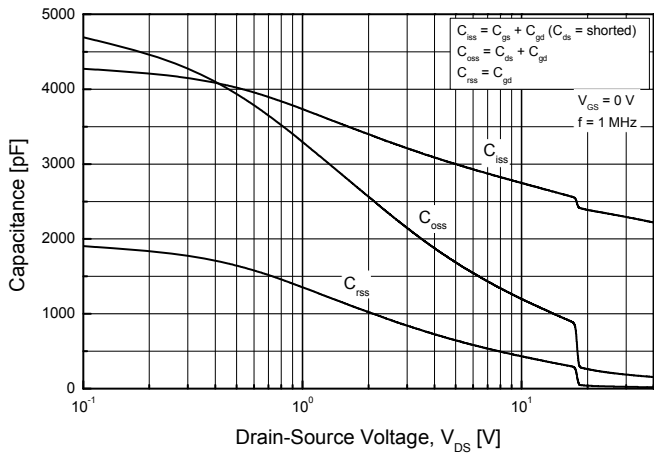
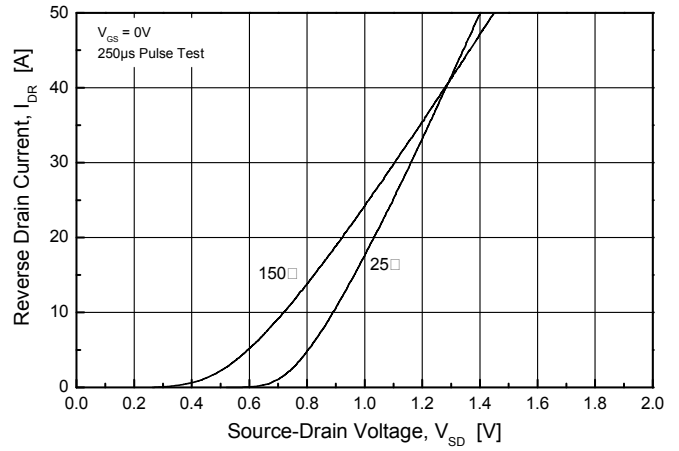
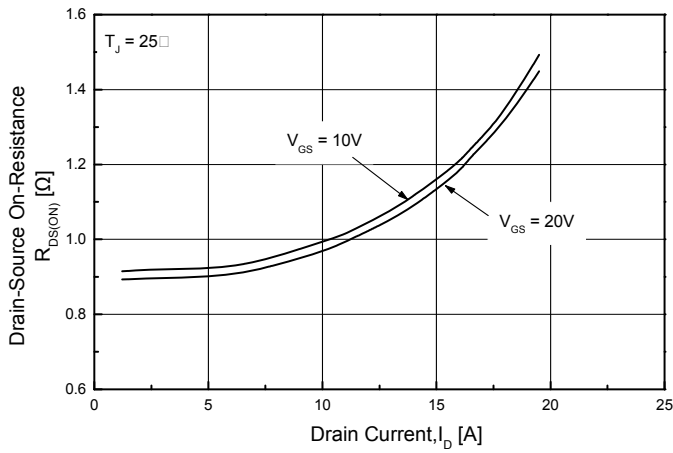
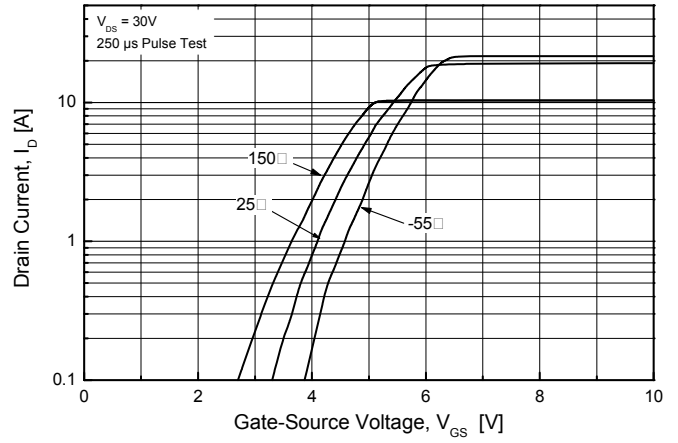
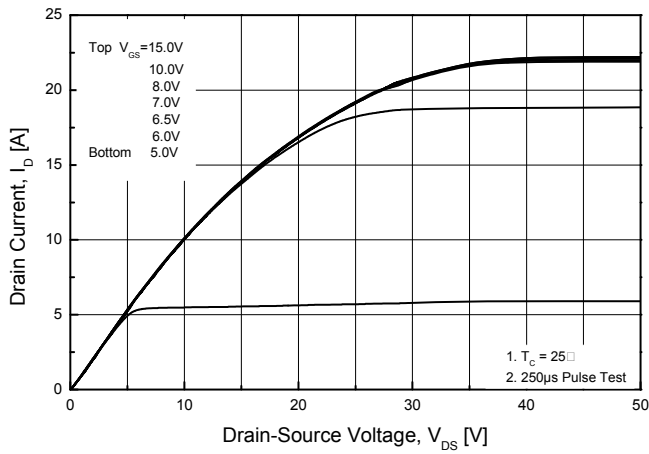

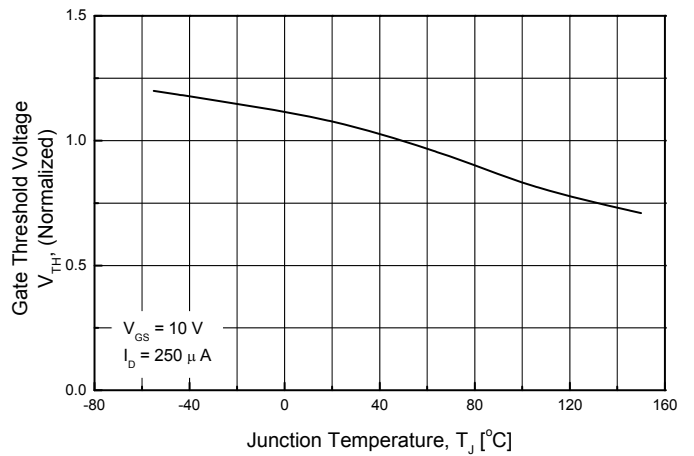
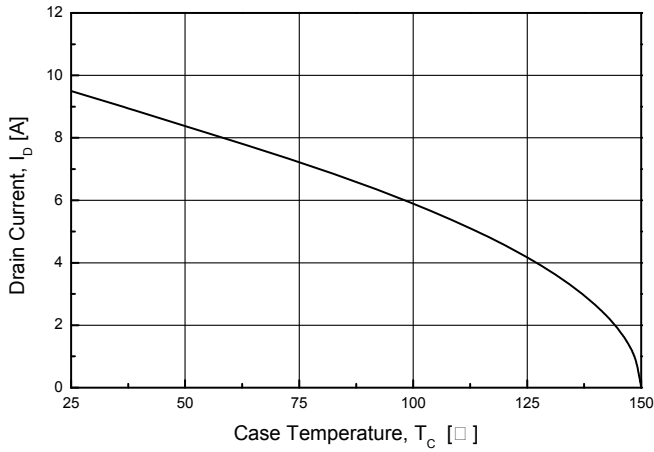
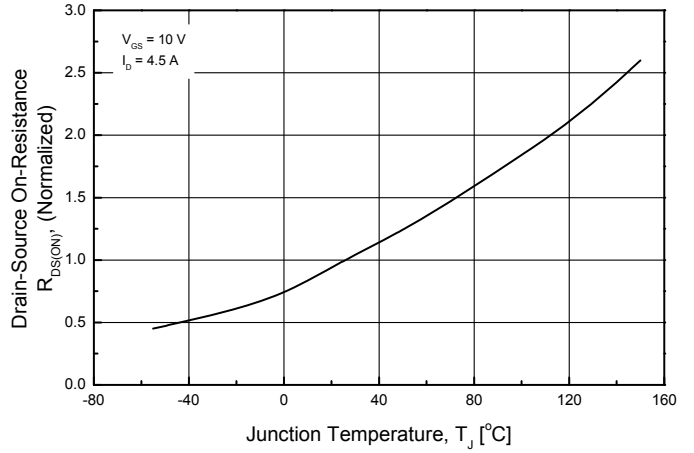
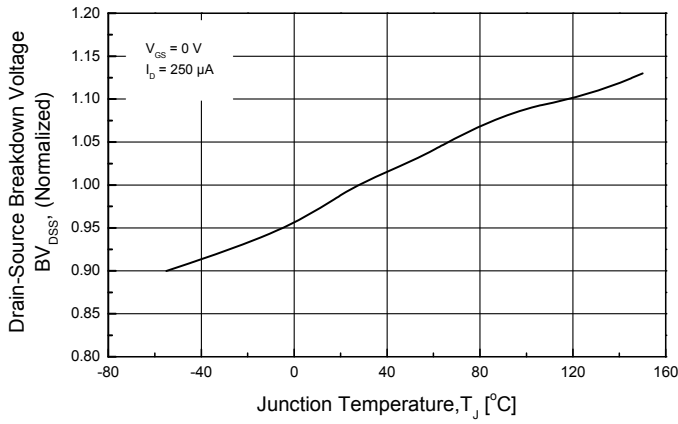

GP1M010A080H

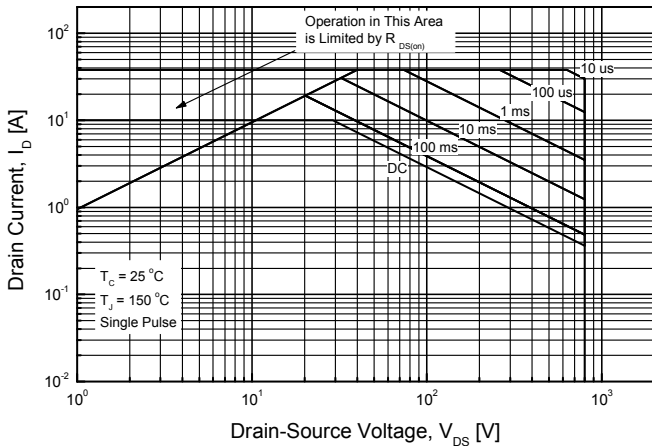

GP1M010A080FH

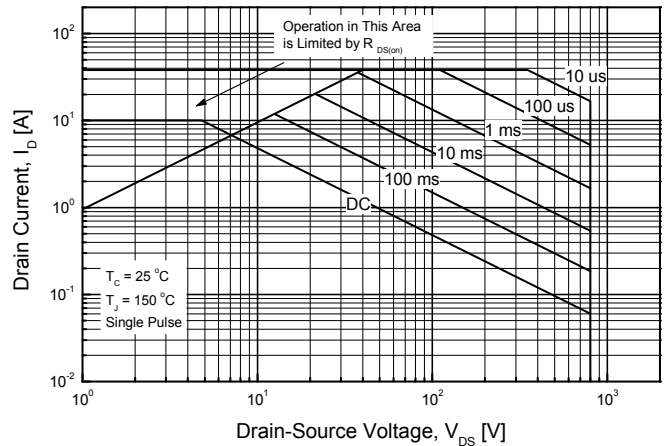

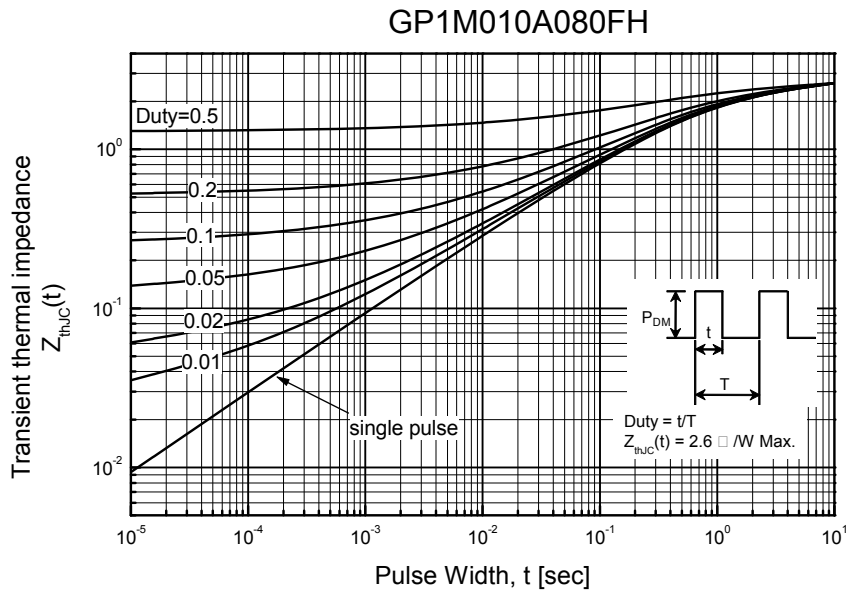
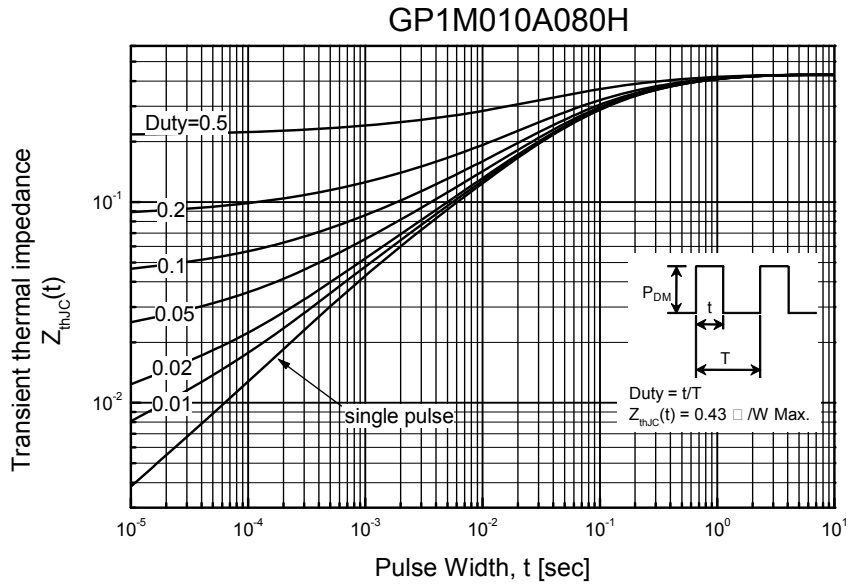

TO-220AB-3L MECHANICAL DATA

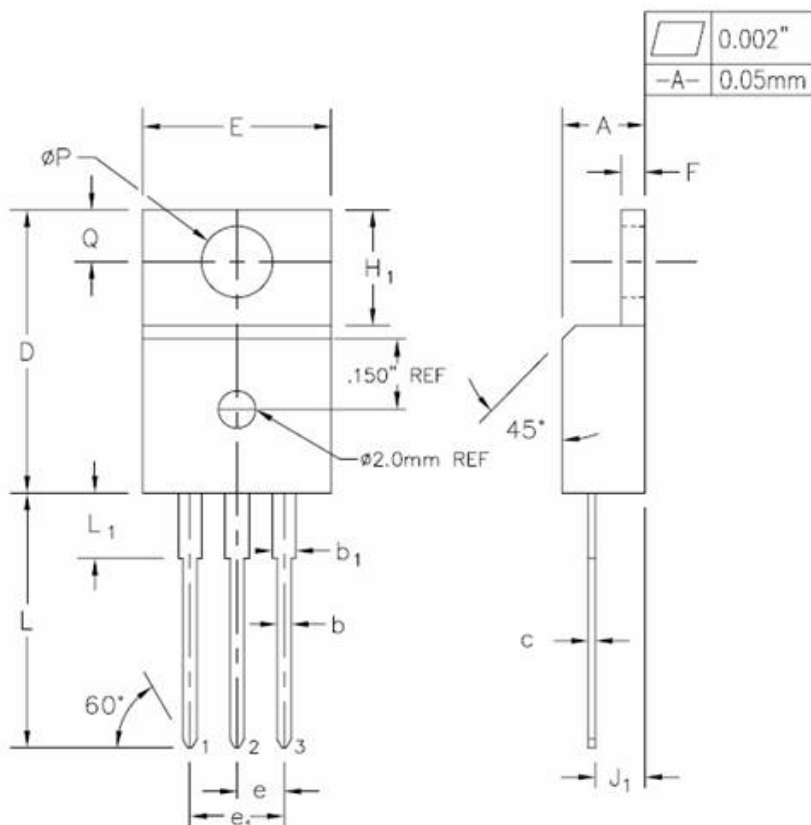

SYMBOL	INCHES		MILLIMETERS		NOTES
	MIN.	MAX.	MIN.	MAX.	
A	0.170	0.180	4.32	4.57	
b	0.028	0.036	0.71	0.91	
b ₁	0.045	0.055	1.15	1.39	
c	0.014	0.021	0.36	0.53	
D	0.590	0.610	14.99	15.49	
E	0.395	0.410	10.04	10.41	
e	0.100 TYP.		2.54 TYP.		
e ₁	0.200 BSC		5.08 BSC		
F	0.048	0.054	1.22	1.37	
H ₁	0.235	0.255	5.97	6.47	
J ₁	0.100	0.110	2.54	2.79	
L	0.530	0.550	13.47	13.97	
L ₁	0.130	0.150	3.31	3.81	2
ϕP	0.149	0.153	3.79	3.88	
Q	0.102	0.112	2.60	2.84	

TO-220F-3L MECHANICAL DATA

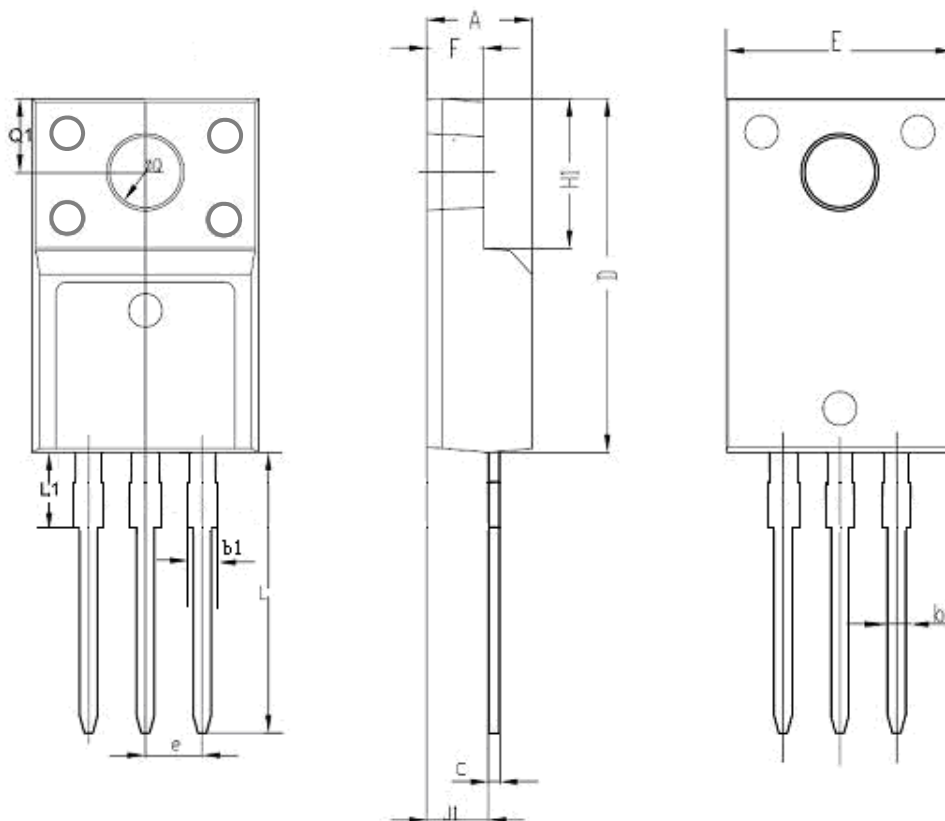

SYMBOL	INCHES		MILLIMETERS		NOTES
	MIN	MAX	MIN	MAX	
A	0.178	0.194	4.53	4.93	
b	0.028	0.036	0.71	0.91	
C	0.018	0.024	0.45	0.60	
D	0.617	0.633	15.67	16.07	
E	0.392	0.408	9.96	10.36	
e	0.100 TYP.		2.54TYP.		
H1	0.256	0.272	6.50	6.90	
J1	0.101	0.117	2.56	2.96	
L	0.503	0.519	12.78	13.18	
φQ	0.117	0.133	2.98	3.38	
b1	0.045	0.055	1.15	1.39	
L1	0.114	0.130	2.9	3.3	
Q1	0.122	0.138	3.10	3.50	
F	0.092	0.108	2.34	2.74	

Disclaimer :

Global Power Technologies Group reserves the right to make changes without notice to products herein to improve reliability, performance, or design. The information given in this document is believed to be accurate and reliable. However, it shall in no event be regarded as a guarantee of conditions and characteristics. With respect to any information regarding the application of the device, Global Power Technologies Group hereby disclaims any and all warranties and liabilities of any kind, including without limitation, warranties of non-infringement of patent rights of any third party.