

APPLICATIONS

The CLHB-IB-100 is an LED I-Beam high bay luminaire designed to illuminate commercial, industrial & retail settings such as warehouses, manufacturing plants, sporting venues and big-box retailers. With a painted, steel housing, the CLHB-IB-100 provides durability and high performance. High-efficiency, long-life LEDs provide both energy and maintenance cost savings compared to traditional, HIB high bays.

FEATURES

- Available in 4000k (neutral white) and 5000k (cool white) color temperatures.*
- Long-life LEDs provide 122,000 hours of operation with at least 70% of initial lumen output (L70).**
- Delivers 13,910 lumens from 100 watts input (139 lumens per watt) at both 4000k & 5000k.*
- Universal 120-277 AC voltage (50-60Hz) is standard.
- 0-10vdc dimming capability is standard.
- Power factor > 0.90.
- Total harmonic distortion < 20%.
- Color rendering index > 80.
- Painted steel housing.
- Options include pendant-mounting kits, surface-mounting kits, diffused lenses, and steel wire-guard kits.
- Easy installation in new construction or retrofit.

*Contact factory for other color temperatures and lumen packages.
 **L70 hours are IES TM-21-11 calculated hours.

STANDARD



PRODUCT PARAMETER

MODEL	COLOR TEMPERATURE	LUMINAIRE LUMENS	LUMINAIRE WATTS	LUMENS PER WATT	DRIVER	OPTIONS (ORDER SEPARATELY)
CLHB-IB-10040	4000K	13,910	100	139	Universal 120-277 AC Voltage, 0-10vdc dimming	CAHB-PMNT = Pendant-mounting kit
CLHB-IB-10050	5000K	13,910	100	139		CAHB-IB-100-LENS = Diffused Lens CAHB-IB-100-WG = Steel wire guard, white



MOUNTING OPTIONS

- Suspension from chains (1/2" chain material, 38" long) is standard. V-hangers, which attach the chain to the luminaire, are included.
- Pendant-mounting requires optional kit CAHB-PMNT (order separately).

Pendant-mount housing slides onto wireway cover grooves

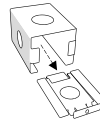

Pendant-mount door secures pendant housing to wireway cover

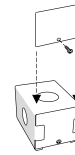

Luminaire hangs from rigid conduit (up to 3/4" diameter)

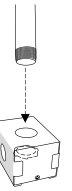

- Luminaire can be surface-mounted using pre-drilled mounting holes in the housing.

WARRANTY/LISTING

- cETLus listed to applicable U.L. standards. Listed for damp locations. Suitable for ambient temperatures from -20°C to 50°C (-4°F to 122°F).
- DLC premium approved.
- Complies with FCC Part 15, class A.
- Complies with IEEE C.62.41-1991, Class A input transient surge protection (2.5kV).
- Complies with RoHS (Restriction on Hazardous Substances) requirements.
- 5-year warranty of all electronics and housing.

DIMENSIONS

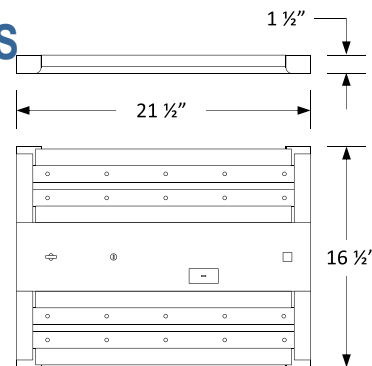

Weight: 7.2 lb.

ELECTRICAL DATA

MODEL	COLOR TEMPERATURE	CRI ¹	LUMINAIRE LUMENS	LUMINAIRE WATTS	LUMENS/WATT	INPUT VOLTAGE	INPUT CURRENT (A)			POWER FACTOR	THD ²	L ₇₀ HOURS ³
							120V	240V	277V			
CAHB-IB-10040	4000K	>80	13,910	100	139	120-277	0.83	0.42	0.36	>90%	<20%	122,000
CAHB-IB-10050	5000K	>80	13,910	100	139	120-277	0.83	0.42	0.36	>90%	<20%	122,000

¹ Color rendering index.

² All 50-60Hz.

³ Total harmonic distortion.

⁴ L₇₀ refers to the number of hours at which lumen output declines to 70% of the initial level. L₇₀ hours are IES TM-21-11 calculated hours.

PHOTOMETRIC DATA

CAHB-IB-10050 (13,910 Lumens)

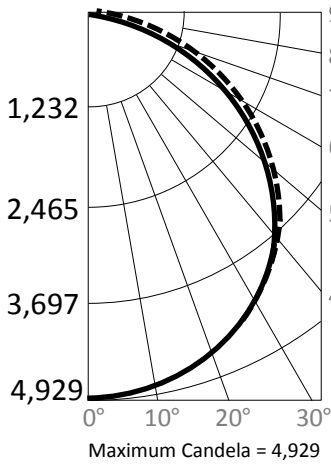

Candlepower Summary

	0°	90°
0°	4,929	4,929
10°	4,804	4,882
20°	4,556	4,646
30°	4,191	4,282
40°	3,719	3,776
50°	2,895	3,137
60°	1,877	2,309
70°	876	1,350
80°	292	425
90°	0	0

Zonal Lumen Summary

Zone	Lumens	% Fixture
0° - 10°	474	3.4%
0° - 20°	1,833	13.2%
0° - 30°	3,910	28.1%
0° - 40°	6,453	46.4%
0° - 50°	9,130	65.6%
0° - 60°	11,508	82.7%
0° - 70°	13,104	94.2%
0° - 80°	13,780	99.1%
0° - 90°	13,910	100.0%
90° - 180°	0	0.0%
0° - 180°	13,910	100.0%

Cone of Light

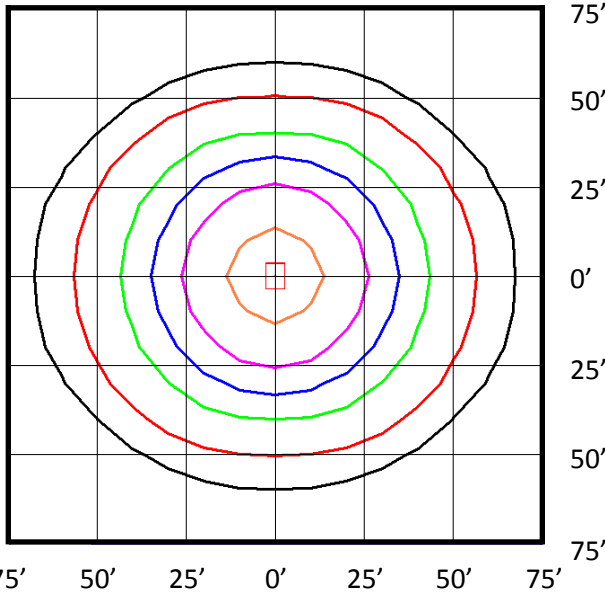
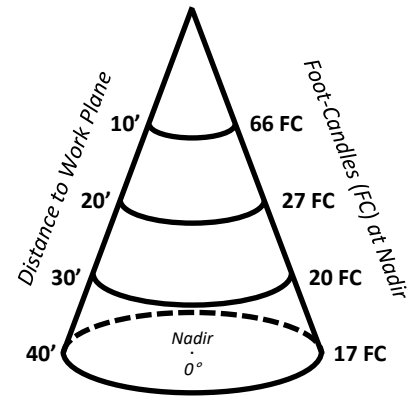

Notes:

- Isofootcandle plots depict initial footcandles at grade.
- Gridlines represent units of mounting height of 25 feet.