

35 Watt DC-DC Converters

IMY 35 Series

Input to output electric strength test up to 2.5 kV DC
Input voltage: 60...150 V DC
2, 3 and 4 outputs
Configurable output voltages from 5 to 60 V DC

- Extremely wide input voltage ranges
- Electrical isolation, also between outputs
- Emissions below EN 55022, level B
- Immunity to IEC/EN 61000-4-2,-3,-4,-5 and -6
- Programmable input undervoltage lock-out
- Shut down input
- Output voltages adjustable with flexible load distribution
- Frequency synchronisation
- Outputs no-load, overload and short-circuit proof
- Operating ambient temperature up to $-40...85^{\circ}\text{C}$
- Thermal protection
- 3" x 2,5" case with 10.5 mm profile or 8.9 mm open frame
- Double or reinforced insulation

Safety according to IEC/EN 60950, UL 1950



Approvals pending

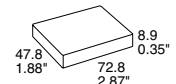
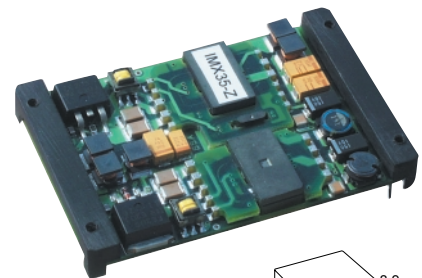
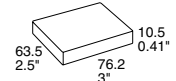
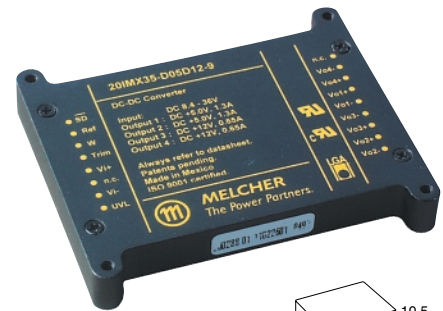

Summary

The IMY 35 series of board mountable 35 Watt DC-DC converters has been designed according to the latest industry requirements and standards. The converters are particularly suitable for use in mobile or stationary applications in transport, railways, industry, or telecommunication where variable input voltages or high transient voltages are prevalent.

With a total input voltage range from 60...150 V, the units are available with double and quadruple outputs, electrically isolated, from 5 V up to 60 V externally adjustable and with flexible load distribution. A shut down input allows remote converter on-off. Features include consistently high efficiency over the entire input voltage range, high reliability and excellent dynamic response to load and line changes.

The converters are designed and built according to the international safety standards IEC/EN 60950, UL 1950, CAN/CSA C22.2 No.950-95. LGA, UL and cUL approvals are in progress.

The circuit comprises of two planar magnetics devices and all components are automatically assembled and solidly soldered onto a single PCB without any wire connection. Magnetic feedback ensures maximum reliability and repeatability in the control loop over all operating conditions. Careful considerations of possible thermal stresses ensure the absence of hot spots providing long life in environments where temperature cycles are a reality. The thermal design without using any potting material allows operation at full load up to an ambient temperature of 71°C in free air. For extremely high vibration environments the case has holes for screw mounting. Various options as e.g. extended temperature range $-40...85^{\circ}\text{C}$ or an alternative pinout provide a high level of application specific engineering and design-in flexibility.

Table of Contents

	Page		Page
Summary	1	Auxiliary Functions	9
Type Survey and Key Data	2	Electromagnetic Compatibility (EMC)	10
Type Key	2	Immunity to Environmental Conditions	11
Functional Description	3	Mechanical Data	12
Electrical Input Data	4	Safety and Installation Instructions	13
Electrical Output Data	6	Description of Option	15

Type Survey and Key Data

Table 1: Type survey

Output 1		Output 2		Output 3		Output 4		Input voltage $U_{i \text{ min...} U_{i \text{ max}}}$ [V DC]	Eff. η_{typ} [%]	Type designation	Trim	Opt.
$U_{o \text{ nom}}$ [V DC]	$I_{o \text{ nom}}$ [A]	$U_{o \text{ nom}}$ [V DC]	$I_{o \text{ nom}}$ [A]	$U_{o \text{ nom}}$ [V DC]	$I_{o \text{ nom}}$ [A]	$U_{o \text{ nom}}$ [V DC]	$I_{o \text{ nom}}$ [A]					
5	2.8	5	2.8	-	-	-	-	60...150	84	110 IMY 35-05-05-9	primary	-8, Z, i
12	1.4	12	1.4	-	-	-	-	60...150	86	110 IMY 35-12-12-9	primary	-8, Z, i
15	1.2	15	1.2	-	-	-	-	60...150	86	110 IMY 35-15-15-9	primary	-8, Z, i
5	1.4	5	1.4	5	1.4	5	1.4	60...150	87	110 IMY 35 D05D05-9	primary	-8, Z, i
12	0.7	12	0.7	12	0.7	12	0.7	60...150	89	110 IMY 35 D12D12-9	primary	-8, Z, i
15	0.6	15	0.6	15	0.6	15	0.6	60...150	89	110 IMY 35 D15D15-9	primary	-8, Z, i

Trim

The Trim input on the primary side (Trim, pin 5) influences all outputs.

Type Key

Dual output units

Input voltage range U_i 60...150 V DC	110
Series	IMY 35
Output 1 of double types	05, 12, 15
Output 2 of double types	05, 12, 15
Operating ambient temperature range T_A -40...71°C (standard)	-9
-40...85°C (option)	-8
Options: Inhibit	i
Open frame	Z

110 IMY 35 - 12 - 12 - 9 i Z

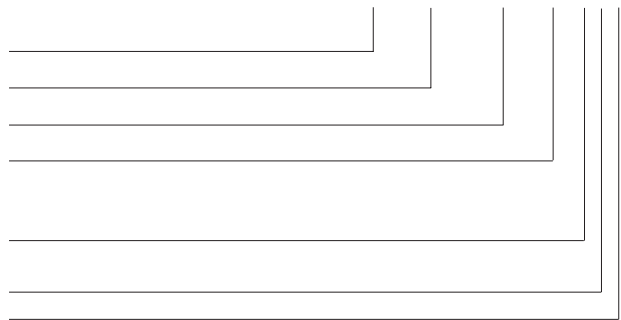

Quad output units

Input voltage range U_i 60...150 V DC	110
Series	IMY 35
Output 1 and 4 of quad types	D05, D12, D15
Output 2 and 3 of quad types	D05, D12, D15
Operating ambient temperature range T_A -40...71°C (standard)	-9
-40...85°C (option)	-8
Options: Inhibit	i
Open frame	Z

110 IMY 35 D05 D05 -9 i Z

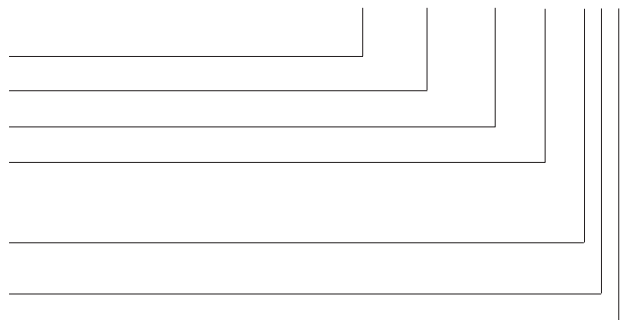

Functional Description

The IMY 35 family of DC-DC converters consists of two feedback controlled interleaved switching flyback power trains using current mode PWM (pulse width modulation). Functionally the converters are of two main types. The dual output types consist of two electrically isolated outputs Vo1, Vo2. Vo1 and Vo2 derives from two power trains and are electrically isolated. Voltage regulation for each output is achieved with passive transformer feedback from the main transformer of each power train. Adjustment of the outputs voltages in the range of 80...105% of $U_{o\ nom}$ is possible via Trim input on the primary side (See: *Block diagram, dual output types*.)

The quadruple output type consists of 4 outputs and two power trains. Vo1, Vo4 derive from the first power train and Vo2, Vo3 from the second one (thus each pair of outputs is independent from the other one). Voltage regulation for each pair of outputs is achieved with passive transformer feedback from the main transformer of each power train.

Each pair of outputs are restricted to being of the same output voltage type (i.e. D05, D12, etc.). If both power trains have the same output voltage, all outputs may be adjusted by means of the Trim input. (In case of different output voltages, the Trim1 input influences only Vo1 and Vo4. See: *Block diagram, quadruple output types*.)

Current limitation is provided by the primary circuit for each power train and limits the possible output power for each pair of outputs. In the case of an overload on either of the power trains which causes the output voltage to fall less than typically 60% of $U_{o\ nom}$, the entire converter will shut down and automatically restart in short intervals.

Overtemperature protection is provided for each power train which will shut down the converter in excessive overload conditions with automatic restart approximately in short intervals.

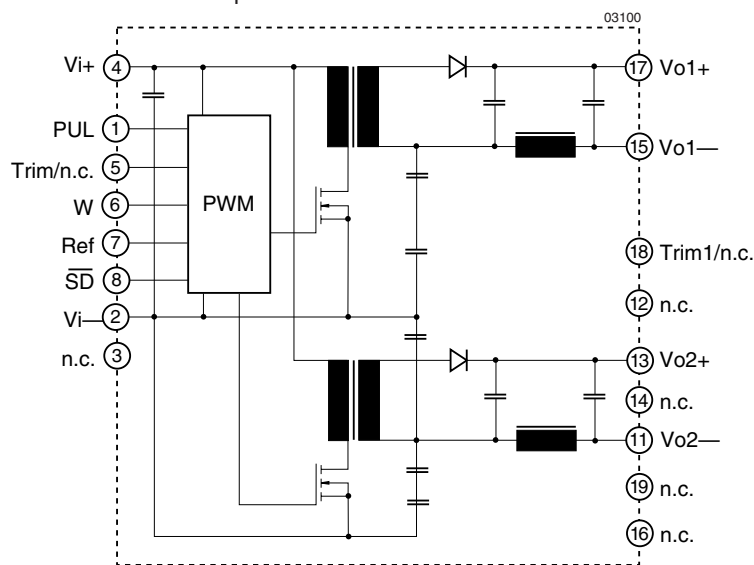

Fig. 1
Block diagram 1, double output types

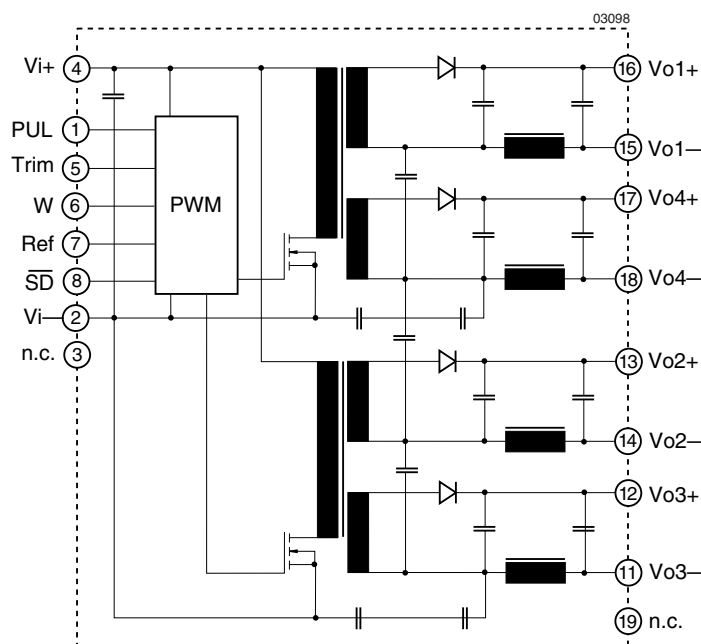

Fig. 2
Block diagram 3, quadruple output types

Electrical Input Data

General conditions:

- $T_A = 25^\circ\text{C}$, unless T_C is specified.
- Shut down pin left open circuit (not connected).
- Trim not connected.

Table 2: Input Data

Input		110 IMY			Unit
Characteristics		min	typ	max	
U_i	Input voltage range ¹	$T_{A \text{ min}} \dots T_{A \text{ max}}$		60 ²	V DC
$U_{i \text{ nom}}$	Nominal input voltage	$I_o = 0 \dots I_{o \text{ nom}}$		110	
$U_{i \text{ sur}}$	Repetitive surge voltage	Abs. max input (3 s)		168	
$t_{\text{start up}}$	Converter start-up time ²	Switch on	Worst case condition at $U_{i \text{ min}}$ and full load		s
		$\overline{\text{SD}}$ high	0.25	0.5	
t_{rise}	Rise time ³	$U_{i \text{ nom}}$ resist load	5		ms
		$I_o \text{ nom}$ capac. load	10	20	
$I_{i \text{ o}}$	No load input current	$I_o = 0, U_{i \text{ min}} \dots U_{i \text{ max}}$		10	mA
I_{rr}	Reflected ripple current	$I_o = 0 \dots I_{o \text{ nom}}$		20	
$I_{\text{inr p}}$	Inrush peak current ⁴	$U_i = U_{i \text{ nom}}$		10	A
C_i	Input capacitance	for surge calculation		0.35	μF
$U_{\overline{\text{SD}}}$	Shut down voltage	Unit shut down		-10...0.7	V DC
		Unit operating			
$R_{\overline{\text{SD}}}$	Shut down input resistance	For current calculations		approx. 10	k Ω
$I_{\overline{\text{SD}}}$	Input current if unit shut down	$U_{i \text{ min}} \dots U_{i \text{ max}}$		1	mA
f_s	Switching frequency	$U_{i \text{ min}} \dots U_{i \text{ max}}, I_o = 0 \dots I_{o \text{ nom}}$		approx. 220	kHz
$U_{i \text{ RFI}}$	Input RFI level, conducted	EN 55022 ⁵		B	

¹ $U_{i \text{ min}}$ will not be as stated if U_o is increased above $U_{o \text{ nom}}$ by use of Trim input. If the output voltage is set to a higher value, $U_{i \text{ min}}$ will be proportionately increased.

² Input undervoltage lock-out at typ. 90% of $U_{i \text{ min}}$.

³ Measured with resistive and max. admissible capacitive load.

⁴ Source impedance according to prETS 300132-2, version 4.3.

⁵ Measured with a lead length of 0.1 m, leads twisted.

Inrush current

The inrush current has been kept as low as possible by choosing a very small input capacitance. A series resistor may be installed in the input line to further reduce this current.

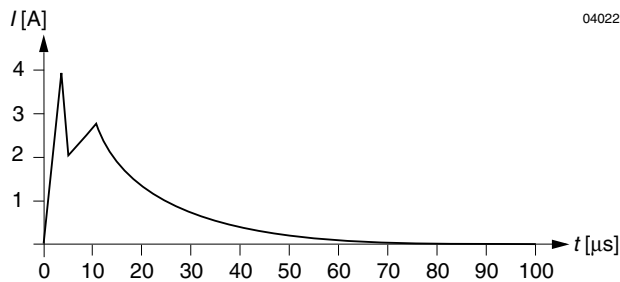

Fig. 3
Typical inrush current at $U_{i\text{ nom}}$, $P_{o\text{ nom}}$ versus time. Source impedance according to prETS 300132-2, version 4.3 at $U_{i\text{ nom}}$.

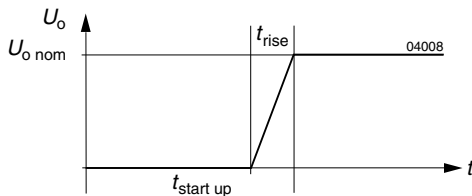

Fig. 4
Converter start-up and rise time

Reverse Polarity Protection

The built-in suppressor diode also provides for reverse polarity protection at the input by conducting current in the reverse direction. An external fuse is required to limit this current.

Table 3: Recommended external fuses

Converter type	Fuse type
110 IMY 35	F2.0A

Input Transient Voltage Protection

A built-in suppressor diode provides effective protection against input transients which may be caused for example by short-circuits across the input lines where the network inductance may cause high energy pulses.

Table 4: Built-in transient voltage suppressor

Type	Breakdown voltage $V_{Br\text{ nom}}$ [V]	Peak power at 1 ms P_p [W]	Peak pulse current I_{pp} [A]
110 IMY 35	167	600	0.5

For very high energy transients as for example to achieve IEC/EN 61000-4-5 or ETR 283 (19 Pf11) compliance (as per table: *Electromagnetic Immunity*) an external inductor and capacitor are required. The components should have similar characteristics as listed in table: *Components for external circuitry for IEC/EN 61000-4-5, level 2 or ETR 283 (19Pf11) compliance.*

Table 5: Components for external circuitry for IEC/EN 61000-4-5, level 2 or ETR 283 (19Pf11) compliance.

Type	Inductor (L)	Capacitor (C)
110 IMY 35	L = 560 μ H/0.84 A OCR = 0.38 Ω	2 x 100 μ F/200 V

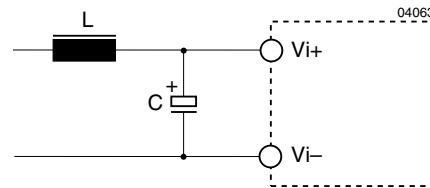

Fig. 5
Example for external circuitry to comply with IEC/EN 61000-4-5 or ETR 283 (19Pf11).

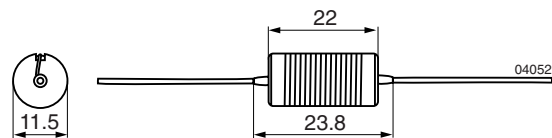

Fig. 6
Dimensions of inductor L for 110 IMY 35 types (e.g. Coil Craft, PCH-45 series).

Electrical Output Data

General conditions:

- $T_A = 25^\circ\text{C}$, unless T_C is specified
- Shutdown pin left open circuit (not connected)
- R input not connected

Table 6: Output data for double output power trains.

Output			2 × 5 V			2 × 12 V			2 × 15 V			Unit
Characteristics	Conditions		min	typ	max	min	typ	max	min	typ	max	
U_{o1} U_{o2}	Output voltage	$U_{i\text{ nom}}$ $I_o = 0.5 I_{o\text{ nom}}$	4.95	5.05		11.88	12.12		14.85	15.15		V DC
$I_{o\text{ nom}}$	Output current		2 × 1.4			2 × 0.70			2 × 0.60			A
I_{oL}	Current limit ¹		3.7			2.0			1.6			
ΔU_{oU}	Line regulation	$U_{i\text{ min}} \dots U_{i\text{ max}}, I_{o\text{ nom}}$	±1			±1			±1			%
ΔU_{oI}	Load regulation	$U_{i\text{ nom}}$ $I_o = (0.1 \dots 1) I_{o\text{ nom}}$	±3			±3			±3			
$u_{o1/2}$	Output voltage noise	$U_{i\text{ min}} \dots U_{i\text{ max}}$ ² $I_o = I_{o\text{ nom}}$ ³	80			120			150			mV _{pp}
U_{oL}	Output overvoltage limit. ⁴	Min. load 1%	115	130		115	130		115	130		%
$C_{o\text{ ext}}$	Admissible capacitive load		4000			470			330			μF
$u_{o\text{ d}}$	Dynamic load regulation	Voltage deviat.	$U_{i\text{ nom}}$			±250			±400			mV
t_d		Recovery time	$I_{o\text{ nom}} \leftrightarrow 1/2 I_{o\text{ nom}}$			1			1			ms
α_{Uo}	Temperature coefficient $\Delta U_o / \Delta T_C$	$U_{i\text{ min}} \dots U_{i\text{ max}}$ $I_o = 0 \dots I_{o\text{ max}}$	±0.02			±0.02			±0.02			%/K

¹ The current limit is primary side controlled. In the event of a sustained overload condition the thermal protection may cause the unit to shutdown (restart on cool-down).

² BW = 20 MHz

³ Measured with a probe according to EN 61204

⁴ The overvoltage protection is via a primary side second regulation loop, not tracking with Trim control.

Thermal Considerations

If a converter, mounted on a PCB, is located in free, quasi-stationary air (convection cooling) at the indicated maximum ambient temperature $T_{A \max}$ (see table: *Temperature specifications*) and is operated at its nominal input voltage and output power, the case temperature T_C measured at the *Measuring point of case temperature T_C* (see: *Mechanical Data*) will approach the indicated value $T_{C \max}$ after the warm-up phase. However, the relationship between T_A and T_C depends heavily on the conditions of operation and integration into a system. The thermal conditions are influenced by input voltage, output current, airflow, temperature of surrounding components and the surfaces and properties of the printed circuit board. $T_{A \max}$ is therefore only an indicative value and under practical operating conditions, the ambient temperature T_A may be higher or lower than this value.

Caution: The case temperature T_C measured at the: *Measuring point of case temperature T_C* (see: *Mechanical Data*) may under no circumstances exceed the specified maximum value. The installer must ensure that under all operating conditions T_C remains within the limits stated in the table: *Temperature specifications*.

Short Circuit Behaviour

The current limit characteristic shuts down the converter whenever a short circuit is applied to an output. It acts self-protecting and automatically recovers after removal of the overload condition (hiccup mode).

Overtemperature Protection

The converters individual power trains are protected against possible overheating by means of an internal temperature monitoring circuit. It shuts down the unit above the internal temperature limit and attempts to automatically restart. This feature prevents from excessive internal temperature building up which could occur under heavy overload conditions.

Connection in Series

The outputs of one or several single or double output power trains may be connected in series without any precautions.

Connection in Parallel

The outputs of one or several double output power trains (except 3.3 or 5.1 V types) with equal nominal output voltage can be connected in parallel. Approximate current sharing between 2 or several power trains is ensured by their load dependent output characteristic.

Output Overvoltage Protection

The outputs of the converter are protected against overvoltages by a second control loop. In the event of an overvoltage on one of the outputs the unit will shut down and attempt to restart in short intervals. The main purpose of this feature is to protect against possible overvoltages which could occur due to a failure in the feedback control circuit. The overvoltage protection is not designed to withstand externally applied overvoltages.

Typical Performance Curves

General conditions:

- $T_A = 25^\circ\text{C}$, unless T_C is specified.
- Shut down pin left open circuit.
- Trim input not connected.

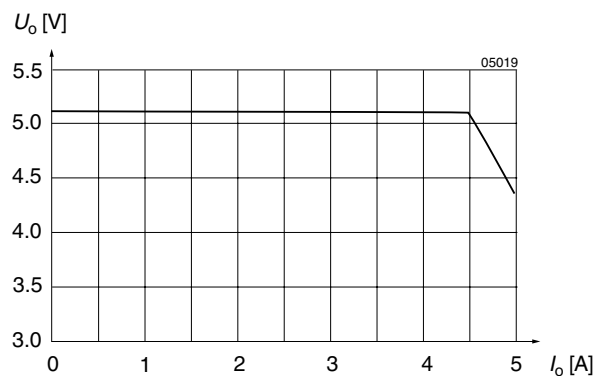

Fig. 7
 U_o versus I_o (typ) of units with $U_o = 5.1$ V.

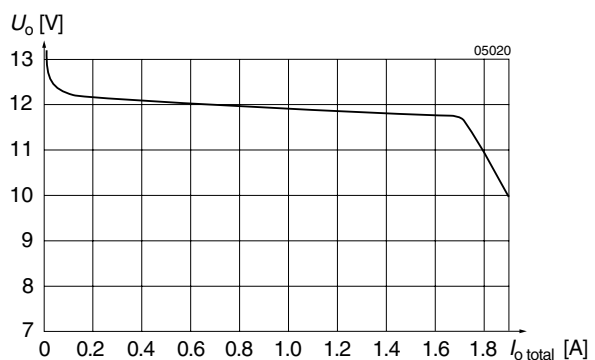

Fig. 8
 $U_{o1/2}$ versus $I_{o1/2}$ of double output power trains (i.e. 2×12 V). See: Block diagram 1

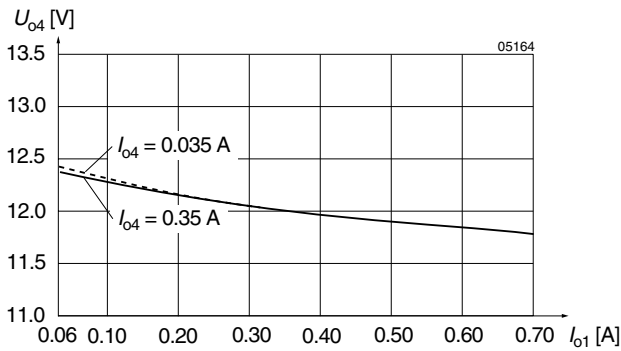

Fig. 9
Cross load regulation U_{o4} versus I_{o1} (typ) for various I_{o4} for Vo1, Vo4 on power train 1. See: Block diagram dual output types. (IMY 35 D12D12-9)

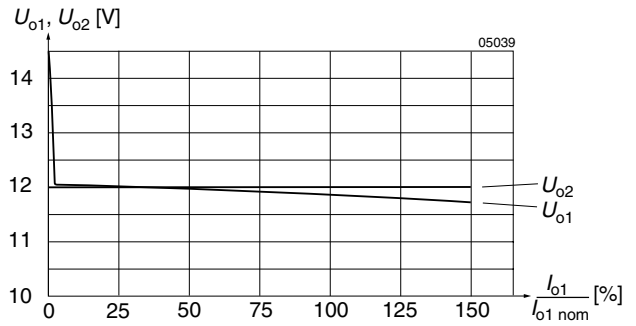

Fig. 10
Flexible load distribution on power train 1 of IMY 35 D12D12-9 (4×12 V) with load variation from 0...150% of $P_{o1 \text{ nom}}$ on output 1 (Vo1). Output 2 (Vo4) loaded with 50% of $P_{o4 \text{ nom}}$.

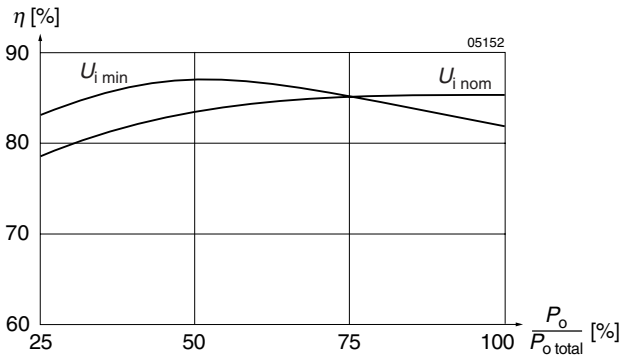

Fig. 11
Efficiency versus input voltage and load. Typical values IMY 35 D12D12-9

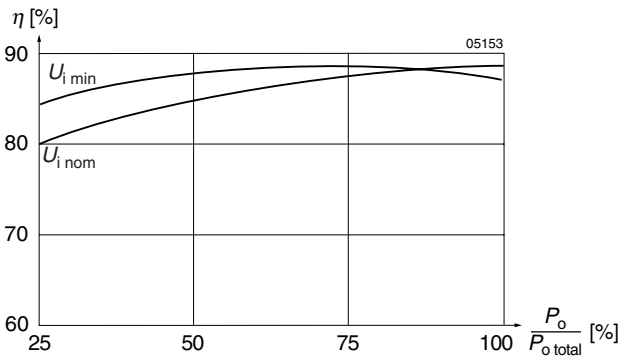

Fig. 12
Efficiency versus input voltage and load. Typical values IMY 35 D12D12-9

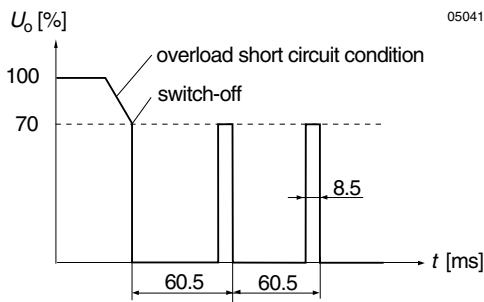

Fig. 13
Overload switch off (hiccup mode), typical values.

Auxiliary Functions

Shut Down Function

The outputs of the converters may be enabled or disabled by means of a logic signal (TTL, CMOS, etc.) applied to the shut down pin. If the shut down function is not required then it should be left open-circuit.

Converter operating: 2.0...20 V

Converter shut down: -10...0.7 V

Programmable Input Undervoltage Lockout PUL

A special feature of these units is the accurate undervoltage lockout protection which protects the units (and system) from large currents caused by operation at low voltages. This ensures easier start-up in distributed power systems.

Table 7: Turn on and turn off voltage

Type	Trigger level	Hysteresis	Units
110 IMY 35	40...42.5	≤1	V

See: *Electrical input data* for a description of the turn on turn off voltage levels of the various types.

The under voltage lockout levels may be programmed by use of an external resistor to Trim up the preset levels as indicated in the table below.

Table 8: Typical values for R_{ext} and the respective lockout voltage for input voltage.

R_{ext} [kΩ]	U_{min} [V]
27	22
10	26
0	30
∞	≤15.5

Adjustable Output Voltage

As a standard feature, the IMY 35 offer adjustable output voltages in the range 80...105% of $U_{o,nom}$ by use of a control input pin. The Trim control is offered either on primary or secondary side of the converter depending on type.

For the dual output types refer to the block diagram 1.

The units IMY 35-12-12 and IMY 35-15-15 exhibit a Trim input connected to pin 5. This input influences both outputs simultaneously. Both power trains have passive transformer feedback and the Trim input (pin 5) is referenced to the primary side. Fig. 16 shows the circuit topology. Adjustment of the output voltage is possible by means of either an external resistor R_{ext} in the range of 100...105% of $U_{o,nom}$ or an external voltage source in the range of 80...105% of $U_{o,nom}$.

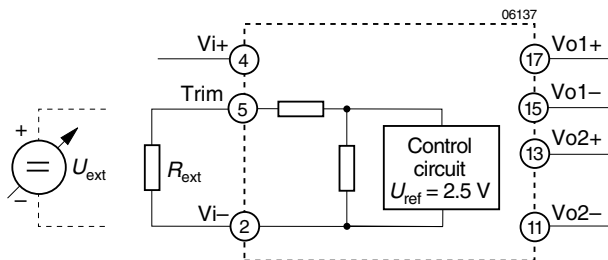

Fig. 14
Output voltage control for double output units by means of the Trim input on the primary side.

a) Adjustment by means of an external resistor R_{ext} :

Adjustment of the output voltage by means of an external resistor R_{ext} is possible within the range of 100...105% of $U_{o,nom}$. R_{ext} should be connected between the Trim pin 5 and Vi-. Connection of R_{ext} to Vi+ may damage the converter. The following table indicates suitable resistor values for typical output voltages under nominal conditions ($U_{i,nom}$, $I_o = 0.5 I_{o,nom}$).

Table 9: R_{ext1} for $U_o > U_{o,nom}$;
approximate values ($U_{i,nom}$, $I_o = 0.5 I_{o,nom}$)

U_o [% $U_{o,nom}$]	R_{ext} [kΩ]
105...108 (107 typically)	0
105	3.3
104	6.2
103	10
102	18
101	39
100	∞

b) Adjustment by means of an external voltage source U_{ext} .

For external output voltage adjustment in the range 80...105% of $U_{o,nom}$ a (0...20 V) source U_{ext} is required, connected to the Trim pin 5 and Vi-. The table below indicates typical U_o versus U_{ext} values. Applying a control voltage 15...20 V will set the converter into a hiccup mode. Direct paralleling of the Trim pins of units of the same type connected in parallel is feasible.

Table 10: U_o versus U_{ext} for $U_o = 80...105\% U_{o,nom}$;
typical values ($U_{i,nom}$, $I_o = 0.5 I_{o,nom}$)

U_o [% $U_{o,nom}$]	U_{ext} [V]
≥105	0
102	1.8
100	2.5
95	4.25
85	8.25
80	10.2

The quadruple output units are shown in block diagram 3. All types with equal output voltage have the Trim function connected to pin 5 referenced to the primary side which influences all outputs simultaneously. The schematics are shown in fig. 16, the values of the adjust resistor R_{ext} in Table 10 and the external voltage source in Table 11.

Synchronisation (W)

This logic input can be used to synchronise the oscillator to an external frequency source. This pin is edge triggered with TTL thresholds, and requires a source frequency of 480...540 kHz (duty cycle 10...90%). The external source frequency is internally divided by 2 to define the switching frequency for the converter. If unused, this pin can be connected to V1- (pin 2) or left open-circuit.

Reference (Ref)

This option provides a stable 5 V (± 0.2 V) reference signal on pin Ref. It is protected by a 1.33 kΩ resistor. This may be used also in conjunction with the Trim input pin 5 (primary side) as a limited external voltage reference. We recommend to connect a filter capacitor (0.1 μF) between Ref and Vi-, if V_{ref} is used.

Electromagnetic Compatibility (EMC)

A suppressor diode together with an input filter form an effective protection against high input transient voltages

which typically occur in many installations, but especially in battery driven mobile applications.

Electromagnetic Immunity

Table 11: Immunity type tests

Phenomenon	Standard ¹	Class Level	Coupling mode ²	Value applied	Waveform	Source Imped.	Test procedure	In oper.	Per- ³ form.
Electrostatic discharge to case	IEC/EN 61000-4-2	2	contact discharge (R pin open)	4000 V _p	1/50 ns	330 Ω	10 positive and 10 negative discharges	yes	B
		3	air discharge (R pin open)	8000 V _p					
Electromagnetic field	IEC/EN 61000-4-3	3	antenna	10 V/m	AM 80% 1 kHz		26...1000 MHz	yes	A
	ENV 50204				PM, 50% duty cycle, 200 Hz resp. frequ.		900 MHz		
Electrical fast transient/burst	IEC/EN 61000-4-4	4	direct +i/-i	4000 V _p	bursts of 5/50 ns 5 kHz rep. rate transients with 15 ms burst duration and a 300 ms period	50 Ω	1 min positive 1 min negative transients per coupling mode	yes	B
Surge	IEC/EN 61000-4-5 ⁴	3	+i/-i	2000 V _p	1.2/50 μs	2 Ω	5 pos. and 5 neg. impulses per coupling mode	yes	B
Conducted disturbances	IEC/EN 61000-4-6	3	+i/-i	10 V _{rms} (140 dBμV)	AM modulated 80%, 1 kHz	50 Ω	0.15...80 MHz 150 Ω	yes	A
Transient	ETR 283 (19 Pfl 1)		+i/-i	150 V _p	0.1/0.3 ms	limited to <100 A	3 positive	yes	B

¹ Related and previous standards are referenced in: *Technical Information: Standards.*

² i = input, o = output.

³ A = normal operation, no deviation from specification, B = temporary deviation from specs. possible.

⁴ External components required.

Electromagnetic Emission

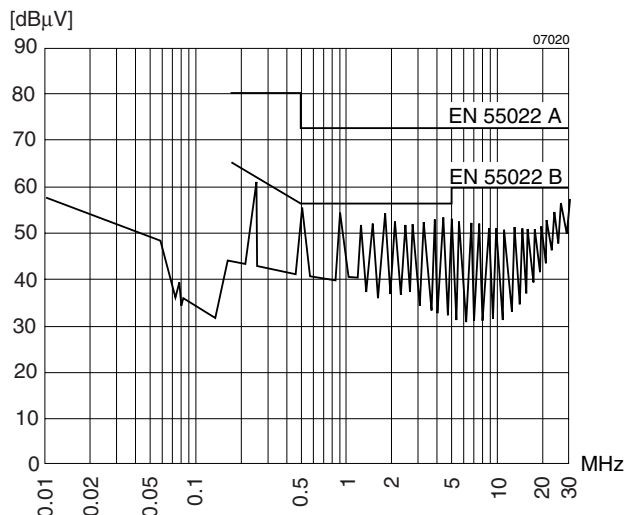

Fig. 15

Typical disturbance voltage (quasi-peak) at the input according to CISPR 11/EN 55011 and CISPR 22/EN 55022, measured at $U_{i\text{ nom}}$ and $I_{o\text{ nom}}$. Output leads 0.1 m, twisted. (IMY 35-D12D12-9)

CISPR 22/EN 55022, Level B Radiated

Electromagnetic emission requirements according to EN 55022, class B (radiated emission) can be achieved by adding an external common mode choke, see: *Input Data*. The filter components should be placed as close as possible to the input of the converter.

Table 12: Input filter components for EN 55022, level B, radiated.

Type	Current compensated choke
110 IMY 35	Murata Part No.:PLH10A1112R6P02

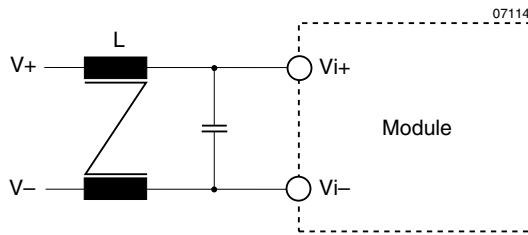

Fig. 16

Example for external circuitry to comply with CISPR22/EN 55022, level B, radiated

Immunity to Environmental Conditions

Table 13: Temperature specifications, valid for air pressure of 800...1200 hPa (800...1200 mbar)

Temperature			-9		Option -8 ³		Unit
Characteristics	Conditions	min	max	min	max		
T_A Ambient temperature ¹	Operational ²	-40	71	-40	85	°C	
T_C Case temperature		-40	95	-40	105		
T_S Storage temperature ¹	Non operational	-55	100	-55	105		

¹ MIL-STD-810D section 501.2 and 502.2

² See: *Thermal Considerations*

³ Start up at -55°C

Table 14: MTBF and device hours

MTBF	Ground Benign	Ground Fixed		Ground Mobile
MTBF acc. to MIL-HDBK-217F	$T_C = 40^\circ\text{C}$	$T_C = 40^\circ\text{C}$	$T_C = 70^\circ\text{C}$	$T_C = 50^\circ\text{C}$
110 IMY 35	h	h	h	h

Table 15: Mechanical stress

Test Method		Standard	Test Conditions		Status
Ca	Damp heat steady state	IEC/DIN IEC 60068-2-3 MIL-STD-810D section 507.2	Temperature: Relative humidity: Duration:	$40 \pm 2^\circ\text{C}$ 93 ^{+2/-3} % 56 days	Unit not operating
Ea	Shock (half-sinusoidal)	IEC/EN/DIN EN 60068-2-27 MIL-STD-810D section 516.3	Acceleration amplitude: Bump duration: Number of bumps:	$100 g_n = 981 \text{ m/s}^2$ 6 ms 18 (3 each direction)	Unit operating
Eb	Bump (half-sinusoidal)	IEC/EN/DIN EN 60068-2-29 MIL-STD-810D section 516.3	Acceleration amplitude: Bump duration: Number of bumps:	$40 g_n = 392 \text{ m/s}^2$ 6 ms 6000 (1000 each direction)	Unit operating
Fc	Vibration (sinusoidal)	IEC/EN/DIN EN 60068-2-6 MIL-STD-810D section 514.3	Acceleration amplitude: Frequency (1 Oct/min): Test duration:	0.35 mm (10...60 Hz) $5 g_n = 49 \text{ m/s}^2$ (60...2000 Hz) 10...2000 Hz 7.5 h (2.5 h each axis)	Unit operating
Fda	Random vibration wide band reproducibility high	IEC 60068-2-35	Acceleration spectral density: Frequency band: Acceleration magnitude: Test duration:	$0.05 g_n^2/\text{Hz}$ 20...500 Hz $4.9 g_{n \text{ rms}}$ 3 h (1 h each axis)	Unit operating
Kb	Salt mist, cyclic (sodium chloride NaCl solution)	IEC/EN/DIN IEC 60068-2-52	Concentration: Duration: Storage: Storage duration: Number of cycles:	5% (30°C) 2 h per cycle 40°C, 93% rel. humidity 22 h per cycle 3	Unit not operating

Mechanical Data

Dimensions in mm. Tolerances ± 0.3 mm unless otherwise indicated.

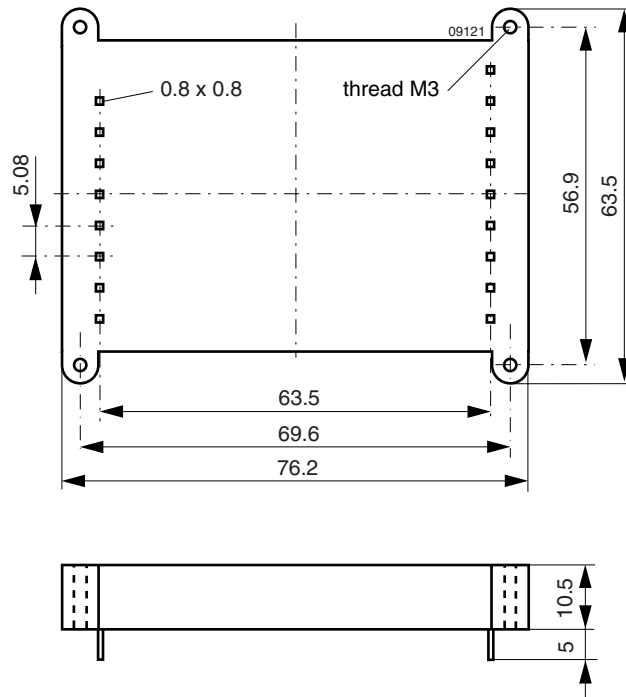

Fig. 17
Case IMY 35 (Standard)
Weight: 67 g

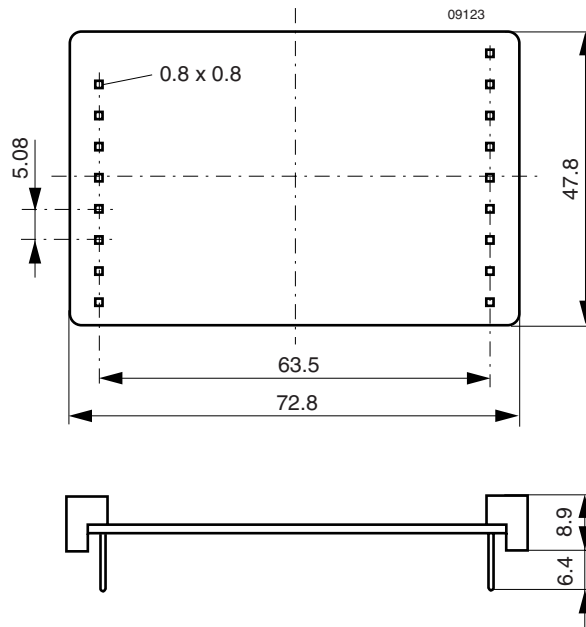

Fig. 18
Case IMY 35 open frame (option Z)
Weight: 43 g

Safety and Installation Instructions

Installation Instructions

Installation of the DC-DC converters must strictly follow the national safety regulations in compliance with the enclosure, mounting, creepage, clearance, casualty, markings and segregation requirements of the end-use application.

Connection to the system shall be made via a printed circuit board with hole diameters of 1.5 mm for the pins.

The units should be connected to a secondary circuit.

Check for hazardous voltages before altering any connections.

Do not open the module.

Ensure that a unit failure (e.g. by an internal short-circuit) does not result in a hazardous condition. See also: *Safety of operator accessible output circuit*.

Input Fuse

To prevent excessive current flowing through the input supply line in case of a short-circuit across the converter input an external fuse should be installed in a non earthed input supply line. We recommend a fast acting fuse F2.0A.

Standards and approvals

All DC-DC converters are pending to be UL recognized according to UL 1950, UL recognized for Canada to CAN/CSA C22.2 No. 950-95 and LGA approved to IEC/EN 60950 standards.

The units have been evaluated for:

- Building in
- Reinforced insulation input to output, based on their maximum input voltage
- The use in a pollution degree 2 environment
- Connecting the input to a secondary circuit which is subject to a maximum transient rating of 2500 V

After approvals the DC-DC converters are subject to manufacturing surveillance in accordance with the above mentioned UL, CSA, EN and with ISO 9001 standards.

Isolation

The electric strength test is performed as factory test in accordance with IEC/EN 60950 and UL 1950 and should not be repeated in the field. Power-One will not honour any guarantee claims resulting from electric strength field tests.

Table 16: Electric strength test voltages

Characteristic	Input to output IMY 35	Output to output	Unit
Electric strength test voltage 1 s	3.0	0.1	kV _{rms}
	2.5	0.5	kV DC
Insulation resistance at 500 V DC	>100	-	MΩ
Partial discharge extinction voltage	Consult factory	-	kV

Table 17: Pin allocation

Pin No.	Double output	Quadruple output
1	PUL	PUL
2	Vi-	Vi-
3	n.c.	n.c.
4	Vi+	Vi+
5	Trim or n.c.	Trim
6	W	W
7	Ref	Ref
8	\overline{SD} or i	\overline{SD} or i
11	Vo2-	Vo3-
12	n.c.	Vo3+
13	Vo2+	Vo2+
14	n.c.	Vo2-
15	Vo1-	Vo1-
16	n.c.	Vo1+
17	Vo1+	Vo4+
18	Trim1 or n.c.	Vo4-
19	n.c.	n.c.

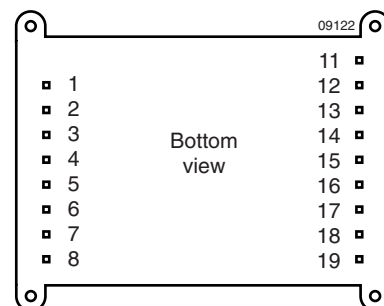

Fig. 19
Pin allocation

Protection Degree

The protection degree of the DC-DC converters is IP 30 (not for option Z).

Cleaning Agents

In order to avoid possible damage, any penetration of cleaning fluids should be prevented, since the power supplies are not hermetically sealed.

Safety of operator accessible output circuit

If the output circuit of a DC-DC converter is operator accessible, it shall be an SELV circuit according to the IEC/EN 60950 related safety standards

The following table shows some possible installation configurations, compliance with which causes the output circuit of the DC-DC converter to be an SELV circuit according to

IEC/EN 60950 up to a configured output voltage (sum of nominal voltages if in series or +/- configuration) of 42 V.

However, it is the sole responsibility of the installer to ensure the compliance with the relevant and applicable safety regulations. More information is given in: *Technical Information: Safety*.

Table 18: Insulation concept leading to an SELV output circuit

Conditions	Front end			DC-DC converter		Result
	Minimum required grade of isolation, to be provided by the AC-DC front end, including mains supplied battery charger	Maximum DC output voltage from the front end ¹	Minimum required safety status of the front end output circuit	Type	Measures to achieve the specified safety status of the output circuit	
Mains ≤150 V AC	Operational (i.e. there is no need for electrical isolation between the mains supply voltage and the DC-DC converter input voltage)	≤150 V	Primary	IMY 35	Double or reinforced insulation, based on 150 V AC and DC (provided by the DC-DC converter)	SELV circuit
Mains ≤250 V AC	Basic	≤60 V	Earthed SELV circuit ²	IMY 35	Operational insulation (provided by the DC-DC converter)	
		≤150 V		IMY 35	Supplementary insulation based on 250 V AC and double or reinforced insulation, based on the maximum rated output voltage from the front end (provided by the DC-DC converter)	
	Double or reinforced	≤60 V	SELV circuit	IMY 35	Operational insulation (provided by the DC-DC converter)	
		≤120 V ≤150 V	TNV-2 circuit Double or reinforced insulated earthed or unearthed hazardous voltage secondary circuit	IMY 35	Double or reinforced insulation, based on the maximum rated output voltage from the front end (provided by the DC-DC converter)	

¹ The front end output voltage should match the specified input voltage range of the DC-DC converter.

² The earth connection has to be provided by the installer according to the relevant safety standard, e.g. IEC/EN 60950.

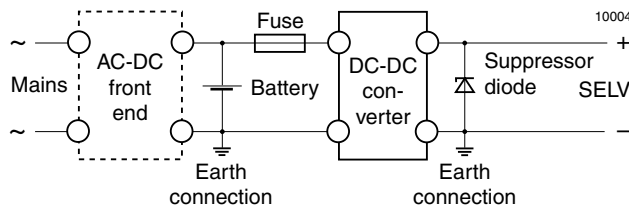

Fig. 20
Schematic safety concept. Use fuse, suppressor diode and earth connection as per table: Safety concept leading to an SELV output circuit.

Description of Options

Table 19: Survey of options

Option	Function of option	Characteristic
-8	Extended operational ambient temperature range	$T_A = -40...85^\circ\text{C}$
Z	Open frame	All models are available without case
i	Inhibit	-

Option -8 Extended Temperature Range

Extension of the temperature range from standard $-40...71^\circ\text{C}$ to $-40...85^\circ\text{C}$. In the upper temperature range the output power derating below should be observed. The modules will provide the specified output power with free air convection cooling.

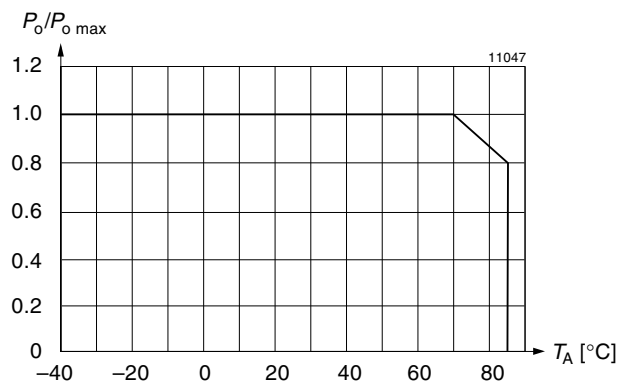

Fig. 21
Maximum allowed output power versus ambient temperature.

Option i Inhibit

The output of the converter may be enabled or disabled by means of a logic signal (TTL, CMOS, etc.) applied to the inhibit pin. No output voltage overshoot will occur when the unit is turned on. If the inhibit function is not required the inhibit (pin 8) should be connected to V_{i-} to enable the output (active low logic, fail safe).

Converter operating: $-10\text{ V}...0.8\text{ V}$

Converter inhibited

or inhibit pin left open circuit: $2.4\text{ V}...U_{I\max}$

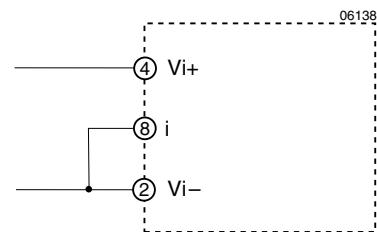

Fig. 22
If the inhibit is not used the inhibit pin should be connected to V_{i-}