

# Features

## Regulated Converters

- 6-Side Shielding
- External ON/OFF control
- 1.6kVDC Isolation
- UL/CSA/EN-60950-1 Certified
- 4:1 Input Voltage Range
- Continuous Short Circuit Protection
- Efficiency up to 89.5%
- Fixed Switching Frequency

### Description

The REC30-xxxxS\_DZ -series offer single and dual regulated outputs in a 2"x1.6" package with 1.6kVDC isolation and are suitable for higher power industrial applications. Remote on/off control is standard. The higher current outputs have raised output voltages to compensate for track losses as standard. The converter is fully certified to UL/EN/IEC safety standards.

### Selection Guide

Part Number	Input Voltage Range [VDC]	Output Voltage [VDC]	Output Current [mA]	Efficiency typ. [%]	max. Capacitive Load <sup>(1)</sup> [μF]
REC30-243.4SZ	9-36	3.4	6000	86.5	10000
REC30-245.1SZ	9-36	5.1	6000	87.5	6800
REC30-2412SZ	9-36	12	2500	88.5	1800
REC30-2415SZ	9-36	15	2000	89	1000
REC30-2412DZ	9-36	±12	±1250	88.5	±800
REC30-2415DZ	9-36	±15	±1000	89	±500
REC30-483.4SZ	18-75	3.4	6000	87	10000
REC30-485.1SZ	18-75	5.1	6000	88	6800
REC30-4812SZ	18-75	12	2500	89	1800
REC30-4815SZ	18-75	15	2000	89.5	1000
REC30-4812DZ	18-75	±12	±1250	88	±800
REC30-4815DZ	18-75	±15	±1000	88.5	±500

#### Notes:

Note1: Max. capacitive load is tested at nominal input voltage and full load.

### Model Numbering



#### Ordering Examples:

REC30-4812SZ, Single Output, 18-75Vin (4:1) and 12Vout  
 REC30-2412DZ, Dual Output, 9-36Vin (4:1) and ±12Vout

## REC30-Z

30 Watt

2" x 1.6"

Single and Dual Output



**CULUS**  
E224736

IEC/EN60950-1 Certified  
 UL60950 Certified  
 CSA C22.2 NO. 60950 Certified  
 EN55022 Certified

**Specifications** (measured @  $t_a = 25^\circ\text{C}$ , nominal input voltage, full load and after warm up unless otherwise specified)

BASIC CHARACTERISTICS					
Parameter	Condition		Min.	Typ.	Max.
Input Voltage Range	nom. Vin= 24V nom. Vin= 48V		9VDC 18VDC		36VDC 75VDC
Start/up Time				20ms	
Under Voltage Lockout (UVLO)	nom. Vin= 24V	DC-DC ON DC-DC OFF		8.3VDC 7.9VDC	
	nom. Vin= 48V	DC-DC ON DC-DC OFF		17.4VDC 16.7VDC	
Output Voltage Trimming	see calculation below				$\pm 10\%$
CTRL ON/OFF	DC-DC ON DC-DC OFF				Open or $3\text{V} < V_r < 12\text{V}$ Short or $0\text{V} < V_r < 1.2\text{V}$
Operating Frequency				350kHz	
Minimum Load			0%		
Output Ripple and Noise <sup>(2)</sup>					100mVp-p

**Notes:**

Note2: Ripple and Noise is measured with a 20MHz bandwidth and a 0.1µF ceramic capacitor.

**Output Voltage Trimming**

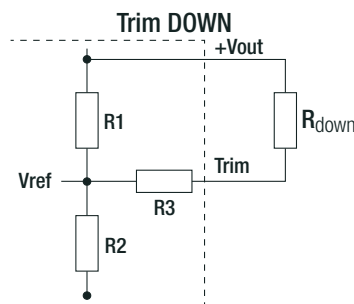
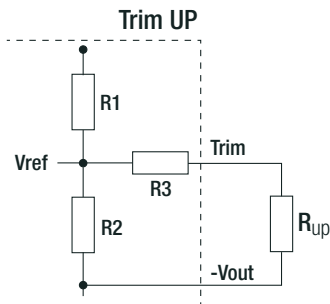

Vout	3.4V	5.1V	12V	15V
R1	2.1 kΩ	2.55 kΩ	9.53 kΩ	9.09 kΩ
R2	1.198 kΩ	2.449 kΩ	2.498 kΩ	1.810 kΩ
R3	6.8 kΩ	9.76 kΩ	16.9 kΩ	13 kΩ
Vref	1.24 V		2.5 V	

**Trim Calculation**

Vout = nom. output voltage

$\Delta V_{out}$  = output voltage trim

R<sub>up</sub> = trim up resistor

R<sub>down</sub> = trim down resistor

a = trim up factor

b = trim down factor

$$\Delta V_{out} = V_{out} - V_{out_{trimmed}}$$

$$R_{up} = q \frac{a \cdot R2}{R2 - a} r - R3 = k\Omega$$

$$R_{down} = q \frac{b \cdot R1}{R1 - b} r - R3 = k\Omega$$

$$a = q \frac{V_{ref}}{(V_{out} + \Delta V_{out}) - V_{ref}} r \cdot R1 = k\Omega$$

$$b = q \frac{(V_{out} + \Delta V_{out}) - V_{ref}}{V_{ref}} r \cdot R2 = k\Omega$$

**Trim Up:**

Vout = 5.1V,  $\Delta V_{out}$  = 0.51V (10%), Vref = 2.5V

$$a = q \frac{2.5V}{(5.1V + 0.51V) - 2.5V} r \cdot 2.55k\Omega = 2.043k\Omega$$

$$R_{up} = q \frac{2.043k\Omega \cdot 2.449k\Omega}{2.449k\Omega - 2.043k\Omega} r - 9.76 = 2.573k\Omega$$

**Trim down:**

Vout = 5.1V,  $\Delta V_{out}$  = -0.51V (-10%), Vref = 2.5V

$$b = q \frac{[5.1V + (-0.51V)] - 2.5V}{2.5V} r \cdot 2.449k\Omega = 2.047k\Omega$$

$$R_{down} = q \frac{2.047k\Omega \cdot 2.55k\Omega}{2.55k\Omega - 2.047k\Omega} r - 9.76k\Omega = 0.627k\Omega$$

continued on next page

**Specifications** (measured @  $t_a = 25^\circ\text{C}$ , nominal input voltage, full load and after warm up unless otherwise specified)

Efficiency vs. Load

REC30-485.1SZ

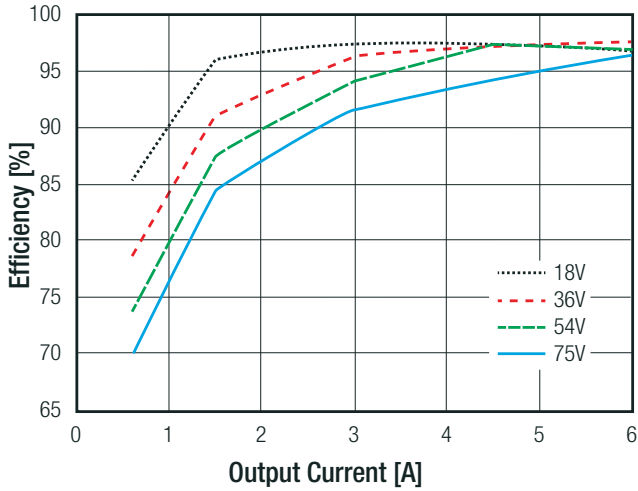

REC30-4815DZ

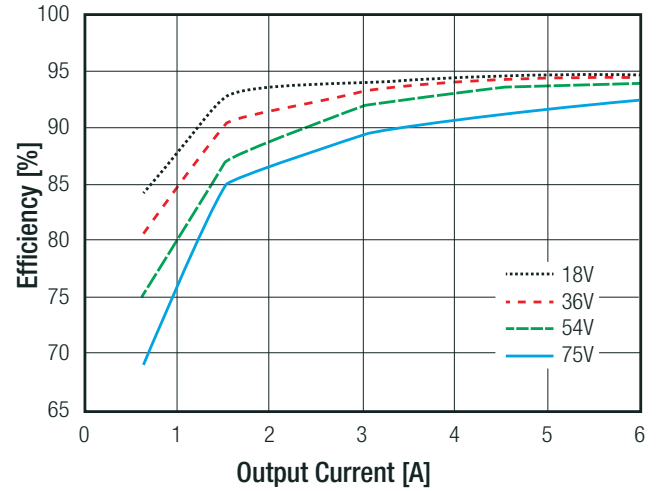

**REGULATIONS**

Parameter	Condition	Type	Values
Output Accuracy			$\pm 1.0\%$ max.
Line Regulation	low line to high line, full load		$\pm 0.2\%$ max.
Load Regulation	10% to 100% load	single output dual output	$\pm 0.5\%$ max. $\pm 1.0\%$ max.
Cross Regulation	25% to 100% load	dual output	$\pm 5.0\%$ max.
Transient Response Recovery Time	25% load step change		250 $\mu\text{s}$ typ.

Deviation vs. Load

REC30-485.1SZ

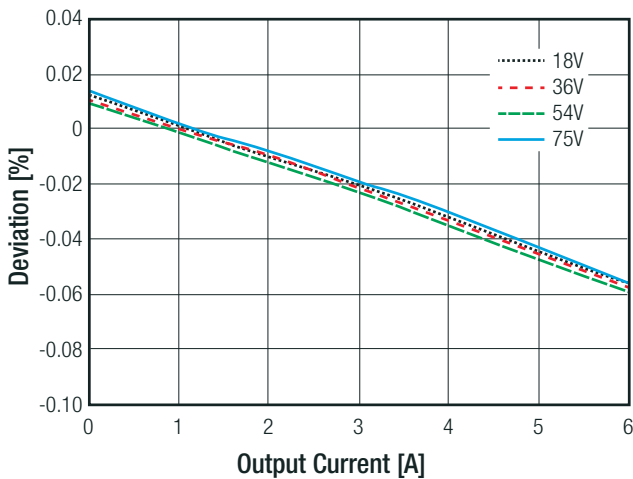

REC30-2415DZ

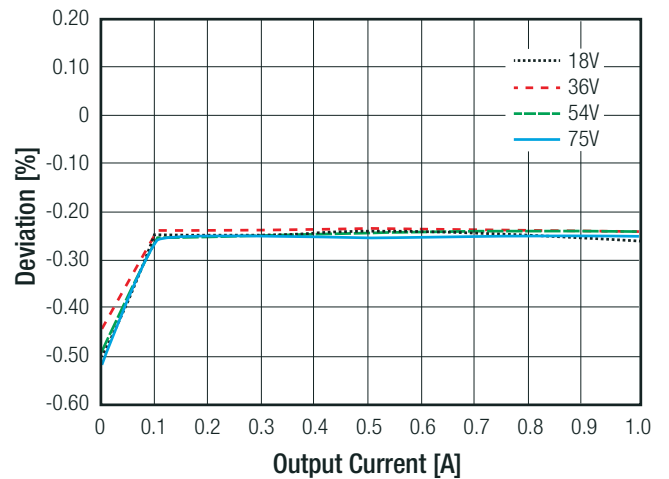

**Specifications** (measured @  $t_a = 25^\circ\text{C}$ , nominal input voltage, full load and after warm up unless otherwise specified)

PROTECTIONS			
Parameter	Condition		Value
Short Circuit Protection (SCP)	below 100mΩ		continuous, automatic recovery
Over Voltage Protection (OVP)	Zener Diode Clamp	3.4Vout	4VDC typ.
		5.1Vout	6.2VDC typ.
		12Vout	15VDC typ.
		15Vout	18VDC typ.
Over Load Protection (OLP)			180% typ.
Isolation Voltage	I/P to O/P	tested for 1 minute	1.6kVDC
Isolation Capacitance			3900pF typ.
Isolation Resistance			1GΩ min.

ENVIRONMENTAL			
Parameter	Condition		Value
Operating Temperature Range	with derating (see graph)		-40°C to +85°C
Maximum Case Temperature			+105°C
Temperatur Coefficient			±0.05%/°C
Thermal Impedance	natural convection (0.1m/s)		8°C/W
Operating Altitude			5000m
Operating Humidity	non-condensing		5% - 95% RH max.
Vibration			MIL-STD-202G
MTBF	according to MIL-HDBK-217F G.B., +25°C, referring to REC30-2415DZ		1541 x 10 <sup>3</sup> hours

**Derating Graph**

@ nominal input voltage, full load and natural convection (0.1m/s)

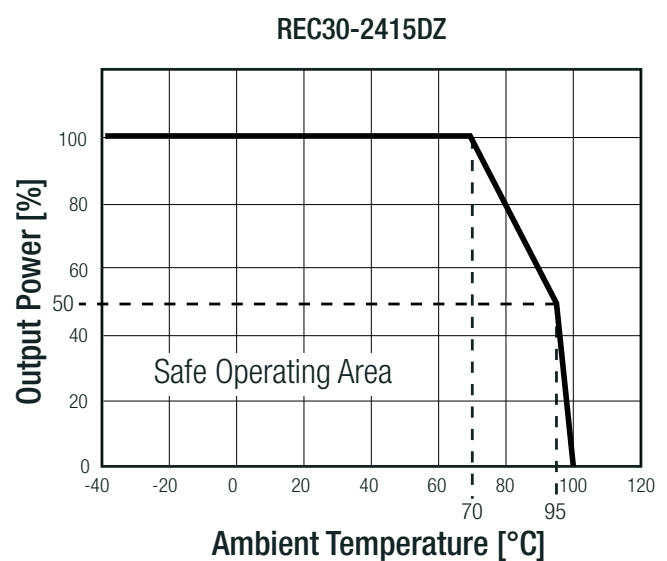
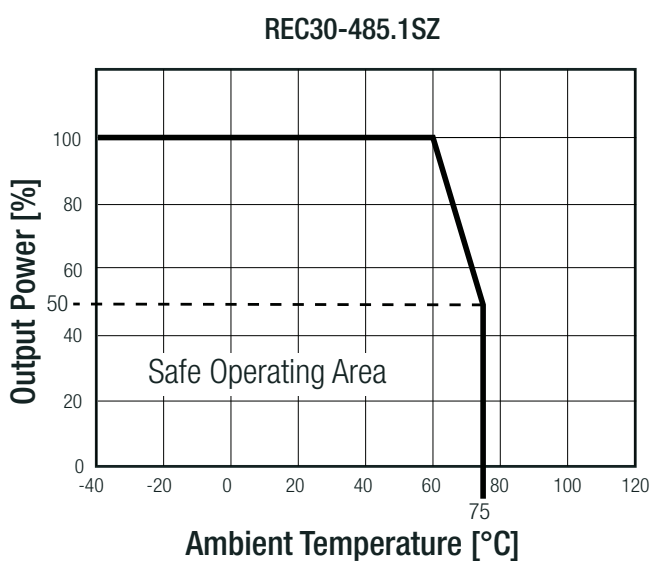

**Notes:**

Note3: For more details, please contact our technical support service at [TechsupportAT@recom-power.com](mailto:TechsupportAT@recom-power.com)

**Specifications** (measured @  $t_a = 25^\circ\text{C}$ , nominal input voltage, full load and after warm up unless otherwise specified)

### SAFETY AND CERTIFICATIONS

Certificate Type	Report / File Number	Standard
CB General Safety	E224736	IEC60950-1, 2nd Edition, 2013
UL General Safety		UL60950-1, 2nd Edition, 2014
EN General Safety		EN60950-1, 2nd Edition, 2013
CAN/CSA General Safety		C22.2 No. 60950-1-07, 2014

EMC Compliance	Condition	Standard / Criterion
EMI	without external filter	EN55022, Class A
	with external filter (see filter suggestions)	EN55022, Class B
ESD	Air: $\pm 8\text{kV}$ ; Contact: $\pm 4\text{kV}$	EN61000-4-2, Criteria B
Radiated Immunity	10V/m	EN61000-4-3, Criteria A
Fast Transient	$\pm 1\text{kV}$	EN61000-4-4, Criteria B
Surge <sup>(4)</sup>	$\pm 1\text{kV}$	EN61000-4-5, Criteria A
Conducted Immunity	10Vr.m.s	EN61000-4-6, Criteria A
Power Magnetic Field	50Hz 1A/m (r.m.s)	EN61000-4-8, Criteria A

**Notes:**

Note4: An external MOV is required if the module has to meet EN61000-4-5. The MOV suggest: NichTek SVI32-380

### EMC Filtering - Suggestions for Class B

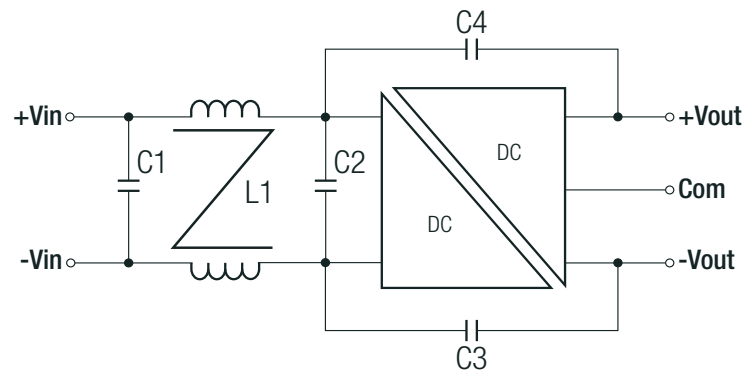

MODEL	C1	C2	L1	C3	C4
REC30-24xxSZ	330 $\mu\text{F}$ /50V	10 $\mu\text{F}$ /50V	1.3mH CMC	2200pF/3kV	NA
REC30-48xxSZ	330 $\mu\text{F}$ /100V	10 $\mu\text{F}$ /100V	1.3mH CMC	2200pF/3kV	NA
REC30-24xxDZ	330 $\mu\text{F}$ /50V	10 $\mu\text{F}$ /50V	1.3mH CMC	2200pF/3kV	2200pF/3kV
REC30-48xxDZ	330 $\mu\text{F}$ /100V	10 $\mu\text{F}$ /100V	1.3mH CMC	2200pF/3kV	2200pF/3kV

### DIMENSION and PHYSICAL CHARACTERISTICS

Parameter	Type	Value
Material	Case	nickel plated copper
	Base	non conductive black plastic
	PCB	FR4
	Potting	epoxy (UL94 V-0)
Package Dimension (LxWxH)		50.8 x 40.6 x 10.2mm
Package Weight		48g typ.

continued on next page

**Specifications** (measured at  $T_a = 25^\circ\text{C}$ , nominal input voltage, full load and after warm up unless otherwise specified)

### Dimension Drawing (mm)

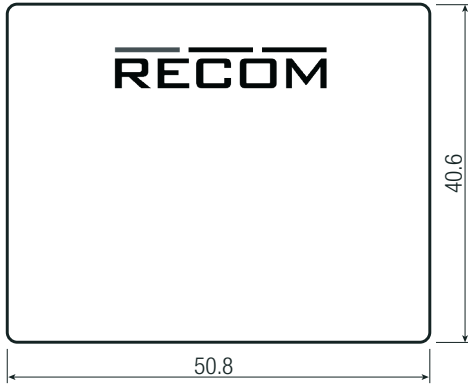
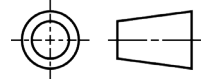

### Pin Connections

Pin #	Single	Dual
1	+Vin	+Vin
2	-Vin	-Vin
4	CTRL ON/OFF	
5	No Pin	+Vout
6	+Vout	Com
7	-Vout	-Vout
8	Trim	Trim

Tolerance: xx.x= ±0.5mm  
 xx.xx= ±0.35mm  
 Pin dimension: ±0.05mm

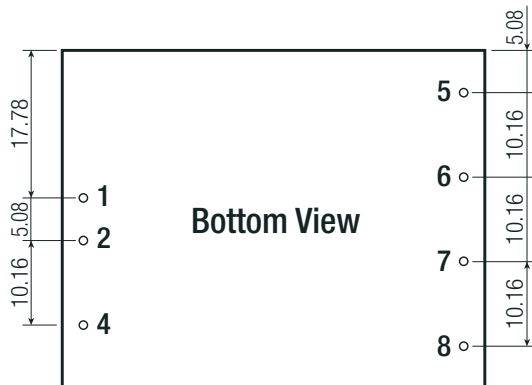
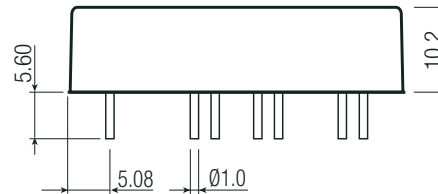
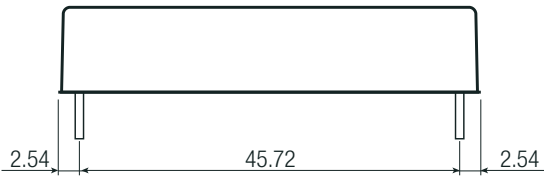

### Recommended Footprint Details

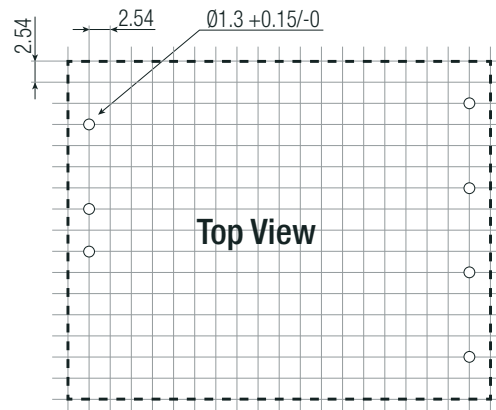

### PACKAGING INFORMATION

Packaging Dimension (LxWxH)	tube	520.0 x 54.5 x 21.0mm
Packaging Quantity		11pcs
Storage Temperature Range		-55°C to +125°C

The product information and specifications are subject to change without prior notice. RECOM products are not authorized for use in safety-critical applications (such as life support) without RECOM's explicit written consent. A safety-critical application is defined as an application where a failure of a RECOM product may reasonably be expected to endanger or cause loss of life, inflict bodily harm or damage property. The buyer shall indemnify and hold harmless RECOM, its affiliated companies and its representatives against any damage claims in connection with the unauthorized use of RECOM products in such safety-critical applications.