

# DELIVERY SPECIFICATION

SPEC. No. C-ISOFD-d

D A T E : Aug, 2020

To

**Non-Controlled Copy**

CUSTOMER'S PRODUCT NAME	TDK PRODUCT NAME MULTILAYER CERAMIC CHIP CAPACITORS (Soft Termination) Tape packaging 【RoHS compliant】 CNC5, CNC6 Type X7R Characteristics
-------------------------	--

Please return this specification to TDK representatives with your signature.  
 If orders are placed without returned specification, please allow us to judge that specification is accepted by your side.

## RECEIPT CONFIRMATION

DATE: \_\_\_\_\_ YEAR \_\_\_\_\_ MONTH \_\_\_\_\_ DAY \_\_\_\_\_

TDK Corporation  
 Sales  
 Electronic Components  
 Sales & Marketing Group

Engineering  
 Electronic Components Business Company  
 Ceramic Capacitors Business Group

APPROVED	Person in charge

APPROVED	CHECKED	Person in charge

**SCOPE**

This delivery specification shall be applied to Multilayer ceramic chip capacitors to be delivered to \_\_\_\_\_.

**PRODUCTION PLACES**

Production places defined in this specification shall be TDK Corporation, TDK(Suzhou)Co.,Ltd and TDK Components U.S.A.,Inc.

**PRODUCT NAME**

The name of the product to be defined in this specifications shall be CNC◇◇◇○○○△△□□□×T※※※A.

**REFERENCE STANDARD**

JIS C 5101-1 : 2010	Fixed capacitors for use in electronic equipment-Part 1: Generic specification
C 5101-22 : 2014	Fixed capacitors for use in electronic equipment-Part22 : Sectional specification : Fixed surface mount multilayer capacitors of ceramic dielectric,Class 2
C 0806-3 : 2014	Packaging of components for automatic handling - Part 3: Packaging of surface mount components on continuous tapes
JEITA RCR-2335 C 2014	Safety application guide for fixed ceramic capacitors for use in electronic equipment

**CONTENTS**

1. CODE CONSTRUCTION
2. OPERATING TEMPERATURE RANGE
3. STORING CONDITION AND TERM
4. P.C. BOARD
5. INDUSTRIAL WASTE DISPOSAL
6. PERFORMANCE
7. INSIDE STRUCTURE AND MATERIAL
8. CAUTION FOR PRODUCTS WITH SOFT TERMINATION
9. PACKAGING
10. RECOMMENDATION
11. SOLDERING CONDITION
12. CAUTION
13. TAPE PACKAGING SPECIFICATION

**<EXPLANATORY NOTE>**

When the mistrust in the spec arises, this specification is given priority. And it will be confirmed by written spec change after conference of both posts involved.

This specification warrants the quality of the ceramic chip capacitor. Capacitors should be evaluated or confirmed a state of mounted on your product.

If the use of the capacitors goes beyond the bounds of this specification, we can not afford to guarantee.

Division	Date	SPEC. No.
Ceramic Capacitors Business Group	Aug, 2020	C-ISOFD-d

## ■ CATALOG NUMBER CONSTRUCTION

<b>CNC</b>	<b>6</b>	<b>P</b>	<b>1</b>	<b>X7R</b>	<b>1H</b>	<b>106</b>	<b>K</b>	<b>250</b>	<b>A</b>	<b>E</b>
(1)	(2)	(3)	(4)	(5)	(6)	(7)	(8)	(9)	(10)	(11)

(1) Series

(2) Dimensions L x W (mm)

Code	EIA	Length	Width	Terminal width
5	CC1206	3.20	1.60	0.30
6	CC1210	3.20	2.50	0.50

(3) Thickness code

Code	Thickness
L	1.60mm
P	2.50mm

(4) Voltage condition for life test

Symbol	Condition
1	1 x R.V.

(5) Temperature characteristics

Temperature characteristics	Capacitance change	Temperature range
X7R	±15%	-55 to +125°C

(6) Rated voltage (DC)

Code	Voltage (DC)
2A	100V
1N	75V
1H	50V
1C	16V

(7) Nominal capacitance (pF)

The capacitance is expressed in three digit codes and in units of pico Farads (pF). The first and second digits identify the first and second significant figures of the capacitance. The third digit identifies the multiplier. R designates a decimal point.

(Example) 0R5 = 0.5pF  
101 = 100pF  
225 = 2,200,000pF = 2.2μF

(8) Capacitance tolerance

Code	Tolerance
K	±10%

(9) Thickness

Code	Thickness
160	1.60mm
250	2.50mm

(10) Packaging style

Code	Style
A	178mm reel, 4mm pitch

(11) Special reserved code

Code	Description
E	Soft termination

## 1. CODE CONSTRUCTION

(Example)  $\frac{\text{CN}}{(1)}$   $\frac{\text{C}}{(2)}$   $\frac{6}{(3)}$   $\frac{\text{P}}{(4)}$   $\frac{1}{(5)}$   $\frac{\text{X7R}}{(6)}$   $\frac{1\text{H}}{(7)}$   $\frac{106}{(8)}$   $\frac{\text{K}}{(9)}$   $\frac{\text{T}}{(10)}$   $\frac{\text{***A}}{(11)}$

(1) Series

Symbol	Series
CN	Soft Termination CN series

(2) Application

Symbol	Application
C	For general electronic equipment

(3) Case size

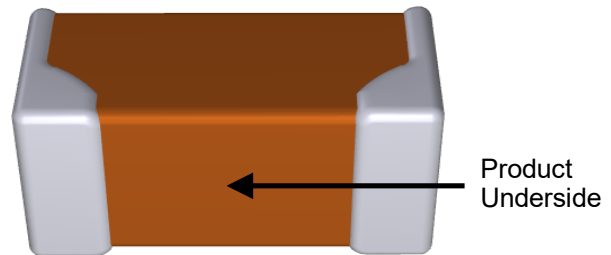
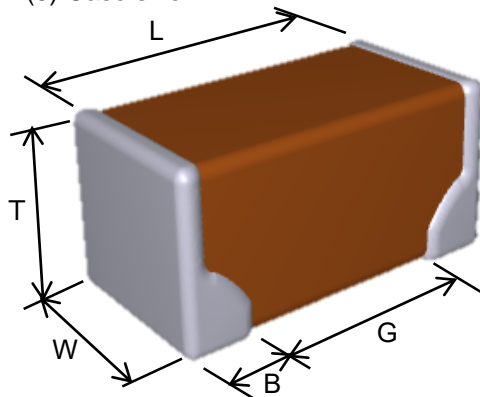

To mount in a specific direction is required for this product.  
Please mount products underside on a substrate.

Case size Symbol	Type (EIA style)	Dimensions (Unit : mm)				
		L	W	T	B	G
5	CNC5 (CC1206)	3.20 <sup>+0.30</sup> - 0.20	1.60 <sup>+0.30</sup> - 0.20	1.60 <sup>+0.30</sup> - 0.20	0.30 min.	1.00 min.
6	CNC6 (CC1210)	3.20±0.30	2.50±0.20	2.50±0.20	0.50 min.	—
			2.50±0.30	2.50±0.30		

\* As for each item, please refer to detail page on TDK web.

(4) Thickness

Symbol	Dimension(mm)
L	1.60
P	2.50

(5) Voltage condition in the life test

\* Details are shown in table1 No.15 at 6.PERFORMANCE.

Symbol	Condition
1	Rated Voltage

(6) Temperature Characteristics

\* Details are shown in table 1 No.6 at 6.PERFORMANCE.

(7) Rated Voltage

Symbol	Rated Voltage
2 A	DC 100 V
1 N	DC 75 V
1 H	DC 50 V
1 C	DC 16 V

## (8) Rated Capacitance

Stated in three digits and in units of pico farads (pF).  
The first and Second digits identify the first and second significant figures of the capacitance, the third digit identifies the multiplier.

(Example)

Symbol	Rated Capacitance
106	10,000,000 pF

## (9) Capacitance tolerance

Symbol	Tolerance
K	± 10 %
M	± 20 %

## (10) Packaging

Symbol	Packaging
T	Taping

## (11) TDK internal code

**2. OPERATING TEMPERATURE RANGE**

Min. operating Temperature	Max. operating Temperature	Reference Temperature
-55°C	125°C	25°C

**3. STORING CONDITION AND TERM**

Storing temperature	Storing humidity	Storing term
5~40°C	20~70%RH	Within 3 months upon receipt.

**4. P.C. BOARD**

When mounting on an aluminum substrate, CNC6[CC1210] type is more likely to be affected by heat stress from the substrate.

Please inquire separate specification when mounted on the substrate.

**5. INDUSTRIAL WASTE DISPOSAL**

Dispose this product as industrial waste in accordance with the Industrial Waste Law.

## 6. PERFORMANCE

table 1

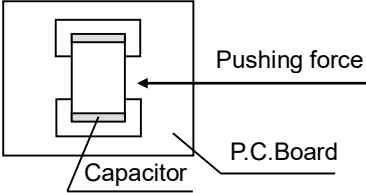
No.	Item	Performance	Test or inspection method													
1	External Appearance	No defects, which may affect performance.	Inspect with magnifying glass (3×)													
2	Insulation Resistance	500MΩ·μF min. (As for the capacitors of rated voltage 16V DC, 100MΩ·μF min.)	Measuring voltage : Rated voltage Voltage application time : 60s.													
3	Voltage Proof	Withstand test voltage without insulation breakdown or other damage.	Apply voltage : 2.5 × rated voltage Voltage application time : 1s. Charge / discharge current : 50mA or lower													
4	Capacitance	Within the specified tolerance.	<table border="1"> <thead> <tr> <th>Measuring frequency</th> <th>Measuring voltage</th> </tr> </thead> <tbody> <tr> <td>1kHz±10%</td> <td>1.0±0.2Vrms</td> </tr> </tbody> </table>	Measuring frequency	Measuring voltage	1kHz±10%	1.0±0.2Vrms									
Measuring frequency	Measuring voltage															
1kHz±10%	1.0±0.2Vrms															
5	Dissipation Factor	Please refer to detail page on TDK web.	See No.4 in this table for measuring condition.													
6	Temperature Characteristics of Capacitance	<table border="1"> <thead> <tr> <th>Capacitance Change (%)</th> </tr> </thead> <tbody> <tr> <td>No voltage applied</td> </tr> <tr> <td>X7R: ± 15</td> </tr> </tbody> </table>	Capacitance Change (%)	No voltage applied	X7R: ± 15	<p>Capacitance shall be measured by the steps shown in the following table, after thermal equilibrium is obtained for each step.</p> <p>ΔC be calculated ref. STEP3 reading.</p> <table border="1"> <thead> <tr> <th>Step</th> <th>Temperature (°C)</th> </tr> </thead> <tbody> <tr> <td>1</td> <td>25 ± 2</td> </tr> <tr> <td>2</td> <td>-55 ± 2</td> </tr> <tr> <td>3</td> <td>25 ± 2</td> </tr> <tr> <td>4</td> <td>125 ± 2</td> </tr> </tbody> </table> <p>As for measuring voltage, please contact with our sales representative.</p>	Step	Temperature (°C)	1	25 ± 2	2	-55 ± 2	3	25 ± 2	4	125 ± 2
Capacitance Change (%)																
No voltage applied																
X7R: ± 15																
Step	Temperature (°C)															
1	25 ± 2															
2	-55 ± 2															
3	25 ± 2															
4	125 ± 2															
7	Robustness of Terminations	No sign of termination coming off, breakage of ceramic, or other abnormal signs.	<p>Reflow solder the capacitors on a P.C.Board shown in Appendix 2.</p> <p>Apply a pushing force gradually at the center of a specimen in a horizontal direction of P.C.board.</p> <p>Pushing force : 5N Holding time : 10±1s</p> 													

(continued)

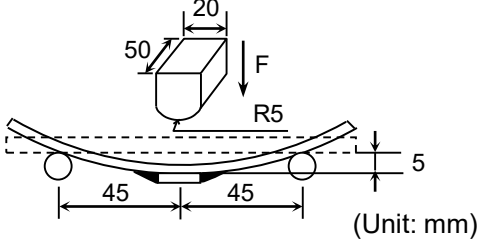
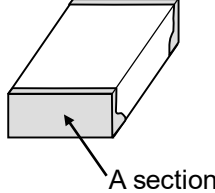
No.	Item	Performance	Test or inspection method														
8	Bending	No crack in the ceramic body.	<p>Reflow solder the capacitor on a P.C.Board shown in Appendix 1.</p>  <p>(Unit: mm)</p>														
9	Solderability	<p>New solder to cover over 75% of termination.</p> <p>25% may have pinholes or rough spots but not concentrated in one spot.</p> <p>Ceramic surface of A sections shall not be exposed due to melting or shifting of termination material.</p>  <p>A section</p>	<p>Solder : Sn-3.0Ag-0.5Cu</p> <p>Flux : Isopropyl alcohol (JIS K 8839) Rosin (JIS K 5902) 25% solid solution.</p> <p>Solder temp. : 245±5°C</p> <p>Dwell time : 3±0.3s.</p> <p>Solder position : Until both terminations are completely soaked.</p>														
10	Resistance to solder heat	<table border="1"> <tr> <td>External appearance</td> <td>No cracks are allowed and terminations shall be covered at least 60% with new solder.</td> </tr> <tr> <td>Capacitance</td> <td> <table border="1"> <thead> <tr> <th>Characteristics</th> <th>Change from the value before test</th> </tr> </thead> <tbody> <tr> <td>X7R</td> <td>± 7.5 %</td> </tr> </tbody> </table> </td> </tr> <tr> <td>D.F.</td> <td>Meet the initial spec.</td> </tr> <tr> <td>Insulation resistance</td> <td>Meet the initial spec.</td> </tr> <tr> <td>Voltage proof</td> <td>No insulation breakdown or other damage.</td> </tr> </table>	External appearance	No cracks are allowed and terminations shall be covered at least 60% with new solder.	Capacitance	<table border="1"> <thead> <tr> <th>Characteristics</th> <th>Change from the value before test</th> </tr> </thead> <tbody> <tr> <td>X7R</td> <td>± 7.5 %</td> </tr> </tbody> </table>	Characteristics	Change from the value before test	X7R	± 7.5 %	D.F.	Meet the initial spec.	Insulation resistance	Meet the initial spec.	Voltage proof	No insulation breakdown or other damage.	<p>Solder : Sn-3.0Ag-0.5Cu</p> <p>Flux : Isopropyl alcohol (JIS K 8839) Rosin (JIS K 5902) 25% solid solution.</p> <p>Solder temp. : 260±5°C</p> <p>Dwell time : 10±1s.</p> <p>Solder position : Until both terminations are completely soaked.</p> <p>Pre-heating : Temp. — 110~140°C Time — 30~60s.</p> <p>Leave the capacitors in ambient condition for 24±2h before measurement.</p>
External appearance	No cracks are allowed and terminations shall be covered at least 60% with new solder.																
Capacitance	<table border="1"> <thead> <tr> <th>Characteristics</th> <th>Change from the value before test</th> </tr> </thead> <tbody> <tr> <td>X7R</td> <td>± 7.5 %</td> </tr> </tbody> </table>	Characteristics	Change from the value before test	X7R	± 7.5 %												
Characteristics	Change from the value before test																
X7R	± 7.5 %																
D.F.	Meet the initial spec.																
Insulation resistance	Meet the initial spec.																
Voltage proof	No insulation breakdown or other damage.																

(continued)

No.	Item	Performance	Test or inspection method															
11	Vibration	External appearance	Frequency : 10~55~10Hz Reciprocating sweep time : 1 min. Amplitude : 1.5mm Repeat this for 2h each in 3 perpendicular directions(Total 6h).  Reflow solder the capacitors on a P.C.Board shown in Appendix 2 before testing.															
	Capacitance	Characteristics		Change from the value before test														
		X7R		± 7.5 %														
D.F.	Meet the initial spec.																	
12	Temperature cycle	External appearance	Expose the capacitors in the condition step1 through step 4 listed in the following table.  Temp. cycle : 5 cycles <table border="1"> <thead> <tr> <th>Step</th> <th>Temperature (°C)</th> <th>Time (min.)</th> </tr> </thead> <tbody> <tr> <td>1</td> <td>-55 ± 3</td> <td>30 ± 3</td> </tr> <tr> <td>2</td> <td>Ambient Temp.</td> <td>2 ~ 5</td> </tr> <tr> <td>3</td> <td>125 ± 2</td> <td>30 ± 2</td> </tr> <tr> <td>4</td> <td>Ambient Temp.</td> <td>2 ~ 5</td> </tr> </tbody> </table> Leave the capacitors in ambient condition for 24±2h before measurement.  Reflow solder the capacitors on a P.C.Board shown in Appendix2 before testing.	Step	Temperature (°C)	Time (min.)	1	-55 ± 3	30 ± 3	2	Ambient Temp.	2 ~ 5	3	125 ± 2	30 ± 2	4	Ambient Temp.	2 ~ 5
		Step		Temperature (°C)	Time (min.)													
		1		-55 ± 3	30 ± 3													
		2		Ambient Temp.	2 ~ 5													
		3		125 ± 2	30 ± 2													
		4		Ambient Temp.	2 ~ 5													
Capacitance	Characteristics	Change from the value before test																
X7R	Please contact with our sales representative.																	
	D.F.	Meet the initial spec.																
Insulation resistance	Meet the initial spec.																	
Voltage proof	No insulation breakdown or other damage.																	
13	Moisture Resistance (Steady State)	External appearance	Test temp. : 40±2°C Test humidity : 90~95%RH Test time : 500 +24,0h Leave the capacitors in ambient condition for 24±2h before measurement.  Reflow solder the capacitors on a P.C.Board shown in Appendix2 before testing.															
		Capacitance		Characteristics	Change from the value before test													
				X7R	Please contact with our sales representative.													
		D.F.		200% of Initial spec max.														
Insulation resistance	50MΩ·μF min. (As for the capacitors of rated voltage 16V DC, 10MΩ·μF min.)																	



(continued)

No.	Item		Performance	Test or inspection method	
14	Moisture Resistance	External appearance	No mechanical damage.	Test temp. : $40\pm 2^{\circ}\text{C}$ Test humidity : 90~95%RH Applied voltage : Rated voltage Test time : 500 +24,0h Charge/discharge current : 50mA or lower Leave the capacitors in ambient condition for $24\pm 2\text{h}$ before measurement.  Reflow solder the capacitors on a P.C.Board shown in Appendix2 before testing.  Initial value setting Voltage conditioning «After voltage treat the capacitors under testing temperature and voltage for 1 hour,» leave the capacitors in ambient condition for $24\pm 2\text{h}$ before measurement. Use this measurement for initial value.	
		Capacitance	Characteristics		Change from the value before test
			X7R		Please contact with our sales representative.
		D.F.	200% of Initial spec max.		
Insulation resistance	25M $\Omega$ · $\mu\text{F}$ min. (As for the capacitors of rated voltage 16V DC, 5M $\Omega$ · $\mu\text{F}$ min.)				
15	Life	External appearance	No mechanical damage.	Test temp. : $125\pm 2^{\circ}\text{C}$ Applied voltage : Please contact with our sales representative.  Test time : 1,000 +48,0h Charge/discharge current : 50mA or lower Leave the capacitors in ambient condition for $24\pm 2\text{h}$ before measurement.  Reflow solder the capacitors on a P.C.Board shown in Appendix2 before testing.  Initial value setting Voltage conditioning «After voltage treat the capacitors under testing temperature and voltage for 1 hour,» leave the capacitors in ambient condition for $24\pm 2\text{h}$ before measurement. Use this measurement for initial value.	
		Capacitance	Characteristics		Change from the value before test
			X7R		Please contact with our sales representative.
		D.F.	200% of Initial spec max.		
Insulation resistance	50M $\Omega$ · $\mu\text{F}$ min. (As for the capacitors of rated voltage 16V DC, 10M $\Omega$ · $\mu\text{F}$ min.)				

\*As for the initial measurement of capacitors on number 6,10,11,12 and 13 leave capacitors at 150 0,-10°C for 1h and measure the value after leaving capacitors for  $24\pm 2\text{h}$  in ambient condition.

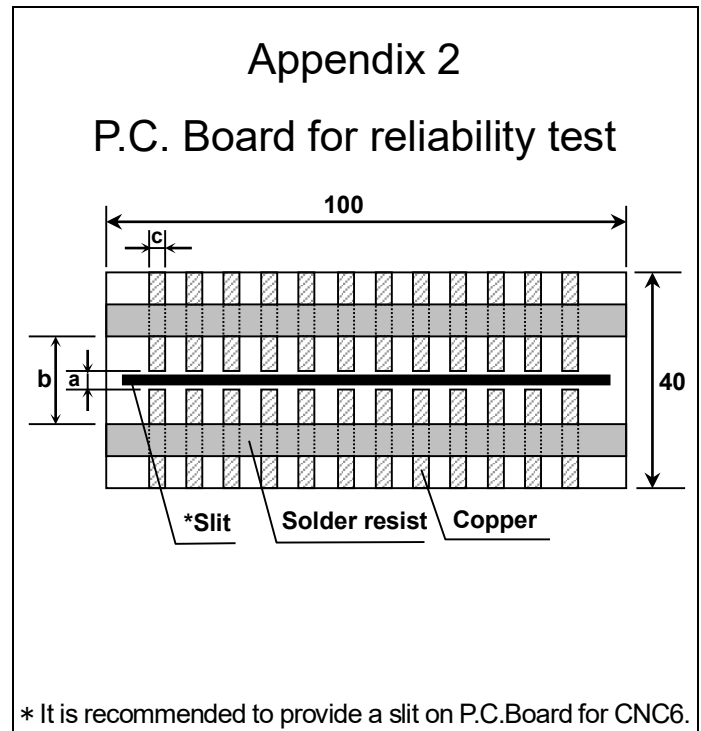
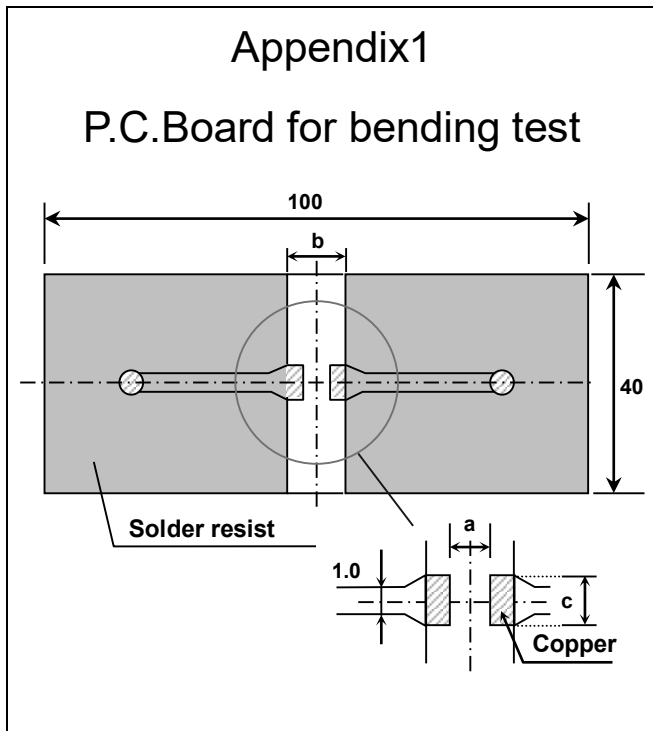

(Unit : mm)

Symbol	a	b	c
Case size			
CNC5 (CC1206)	2.2	5.0	2.0
CNC6 (CC1210)	2.2	5.0	2.9

1. Material : Glass Epoxy(As per JIS C6484 GE4)

2. Thickness : 1.6mm

Copper(Thickness:0.035mm)

Solder resist

## 7. INSIDE STRUCTURE AND MATERIAL

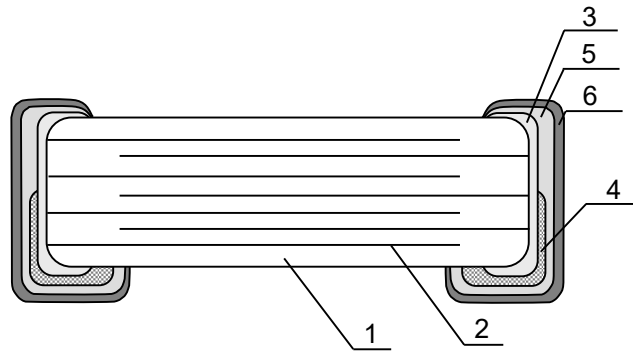

No.	NAME	MATERIAL
1	Dielectric	BaTiO <sub>3</sub>
2	Electrode	Nickel (Ni)
3	Termination	Copper (Cu)
4		Conductive resin (Filler : Ag)
5		Nickel (Ni)
6		Tin (Sn)

## 8. CAUTION FOR PRODUCTS WITH SOFT TERMINATION

This product contains Ag (Silver) as part of the middle layer of termination.

To avoid electromigration of Ag under high temperature and humidity, and failures caused by corrosive gas, chip capacitors on P.C boards should be protected by moisture proof-sealing.

## 9. PACKAGING

Packaging shall be done to protect the components from the damage during transportation and storing, and a label which has the following information shall be attached.

Tape packaging is as per 13. TAPE PACKAGING SPECIFICATION.

- 1) Inspection No.
- 2) TDK P/N
- 3) Customer's P/N
- 4) Quantity

\*Composition of Inspection No.

Example     E 0 A - 23 - 001  
                   (a) (b) (c)     (d)        (e)

- (a) Line code
- (b) Last digit of the year
- (c) Month and A for January and B for February and so on. (Skip I)
- (d) Inspection Date of the month.
- (e) Serial No. of the day

\*Composition of new Inspection No.

(Implemented on and after May 1, 2019 in sequence)

Example     

I	F	0	E	2	3	A	0	0	1
(a)	(b)	(c)	(d)	(e)	(f)	(g)			

- (a) Prefix
- (b) Line code
- (c) Last digit of the year
- (d) Month and A for January and B for February and so on. (Skip I)
- (e) Inspection Date of the month.
- (f) Serial No. of the day(00 ~ ZZ)
- (g) Suffix(00 ~ ZZ)

\* It was shifted to the new inspection No. on and after May 2019, but the implementation timing may be different depending on shipment bases.

Until the shift is completed, either current or new composition of inspection No. will be applied.

## 10. RECOMMENDATION

As for CNC6 [CC1210], It is recommended to provide a slit (about 1mm wide) in the board under the components to improve washing Flux. And please make sure to dry detergent up completely before.

## 11. SOLDERING CONDITION

Reflow soldering only.

## 12. CAUTION

No.	Process	Condition
1	Operating Condition (Storage, Use, Transportation)	<p>1-1. Storage, Use</p> <p>The capacitors must be stored in an ambient temperature of 5 to 40°C with a relative humidity of 20 to 70%RH. JIS C 60721-3-1 Class 1K2 should be followed for the other climatic conditions.</p> <ol style="list-style-type: none"> <li>1) High temperature and humidity environment may affect a capacitor's solder ability because it accelerates terminal oxidization. They also deteriorate performance of taping and packaging. Therefore, SMD capacitors shall be used within 3 months. For capacitors with terminal electrodes consisting of silver or silver-palladium which tend to become oxidized or sulfurized, use as soon as possible, such as within one month after opening the bag.</li> <li>2) When capacitors are stored for a longer time period than 3 months, confirm the solderability of the capacitors prior to use. During storage, keep the minimum packaging unit in its original packaging without opening it. Do not deviate from the above temperature and humidity conditions even for a short term.</li> <li>3) Corrosive gasses in the air or atmosphere may result in deterioration of the reliability, such as poor solderability of the terminal electrodes. Do not store capacitors where they will be exposed to corrosive gas (e.g., hydrogen sulfide, sulfur dioxide, chlorine ammonia etc.)</li> <li>4) Solderability and electrical performance may deteriorate due to photochemical change in the terminal electrode if stored in direct sunlight, or due to condensation from rapid changes in humidity. The capacitors especially which use resin material must be operated and stored in an environment free of dew condensation, as moisture absorption due to condensation may affect the performance.</li> <li>5) Refer to JIS C 60721-3-1, class 1K2 for other climate conditions.</li> </ol> <p>1-2. Handling in transportation</p> <p>In case of the transportation of the capacitors, the performance of the capacitors may be deteriorated depending on the transportation condition. (Refer to JEITA RCR-2335C 9.2 Handling in transportation)</p>
2	Circuit design  Caution	<p>2-1. Operating temperature</p> <ol style="list-style-type: none"> <li>1) Upper category temperature (maximum operating temperature) is specified. It is necessary to select a capacitor whose rated temperature is higher than the operating temperature. Also, it is necessary to consider the temperature distribution in the equipment and seasonal temperature variation.</li> <li>2) Do not use capacitors above the maximum allowable operating temperature. Surface temperature including self heating should be below maximum operating temperature. (Due to dielectric loss, capacitors will heat itself when AC is applied. Especially at high frequencies around its SRF, the heat might be so extreme that it may damage itself or the product mounted on. Please design the circuit so that the maximum temperature of the capacitors including the self heating to be below the maximum allowable operating temperature. Temperature rise at capacitor surface shall be below 20°C)</li> <li>3) The electrical characteristics of the capacitors will vary depending on the temperature. The capacitors should be selected and designed in taking the temperature into consideration.</li> </ol> <p>2-2. When overvoltage is applied</p> <p>Applying overvoltage to a capacitor may cause dielectric breakdown and result in a short circuit. The duration until dielectric breakdown depends on the applied voltage and the ambient temperature.</p>

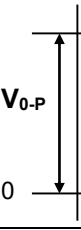
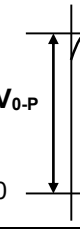
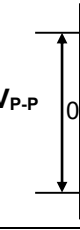
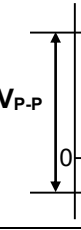
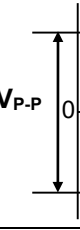
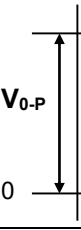
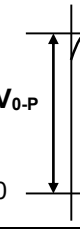
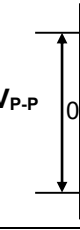
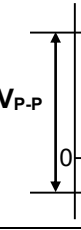
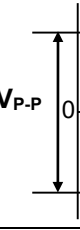
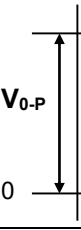
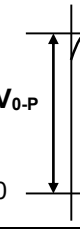
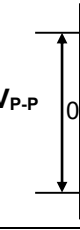
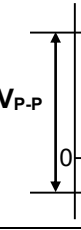
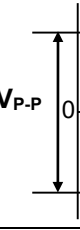
No.	Process	Condition														
2	Circuit design  Caution	<p>2-3. Operating voltage</p> <p>1) Operating voltage across the terminals should be below the rated voltage.            When AC and DC are super imposed, <math>V_{0-P}</math> must be below the rated voltage.            — (1) and (2)</p> <p>AC or pulse with overshooting, <math>V_{P-P}</math> must be below the rated voltage.            — (3), (4) and (5)</p> <p>When the voltage is started to apply to the circuit or it is stopped applying, the irregular voltage may be generated for a transit period because of resonance or switching. Be sure to use the capacitors within rated voltage containing these Irregular voltage.</p> <table border="1" data-bbox="485 517 1473 790"> <thead> <tr> <th data-bbox="485 517 687 562">Voltage</th> <th data-bbox="687 517 948 562">(1) DC voltage</th> <th data-bbox="948 517 1208 562">(2) DC+AC voltage</th> <th data-bbox="1208 517 1473 562">(3) AC voltage</th> </tr> </thead> <tbody> <tr> <td data-bbox="485 562 687 790">Positional Measurement (Rated voltage)</td> <td data-bbox="687 562 948 790">  </td> <td data-bbox="948 562 1208 790">  </td> <td data-bbox="1208 562 1473 790">  </td> </tr> </tbody> </table> <table border="1" data-bbox="485 819 1208 1093"> <thead> <tr> <th data-bbox="485 819 687 864">Voltage</th> <th data-bbox="687 819 948 864">(4) Pulse voltage (A)</th> <th data-bbox="948 819 1208 864">(5) Pulse voltage (B)</th> </tr> </thead> <tbody> <tr> <td data-bbox="485 864 687 1093">Positional Measurement (Rated voltage)</td> <td data-bbox="687 864 948 1093">  </td> <td data-bbox="948 864 1208 1093">  </td> </tr> </tbody> </table> <p>2) Even below the rated voltage, if repetitive high frequency AC or pulse is applied, the reliability of the capacitors may be reduced.</p> <p>3) The effective capacitance will vary depending on applied DC and AC voltages. The capacitors should be selected and designed in taking the voltages into consideration.</p> <p>4) Abnormal voltage (surge voltage, static electricity, pulse voltage, etc.) shall not exceed the rated voltage.</p> <p>5) When capacitors are used in a series connection, it is necessary to add a balancing circuit such as voltage dividing resistors in order to avoid an imbalance in the voltage applied to each capacitor.</p> <p>2-4. Frequency</p> <p>When the capacitors are used in AC and/or pulse voltages, the capacitors may vibrate themselves and generate audible sound.</p>	Voltage	(1) DC voltage	(2) DC+AC voltage	(3) AC voltage	Positional Measurement (Rated voltage)				Voltage	(4) Pulse voltage (A)	(5) Pulse voltage (B)	Positional Measurement (Rated voltage)		
Voltage	(1) DC voltage	(2) DC+AC voltage	(3) AC voltage													
Positional Measurement (Rated voltage)																
Voltage	(4) Pulse voltage (A)	(5) Pulse voltage (B)														
Positional Measurement (Rated voltage)																

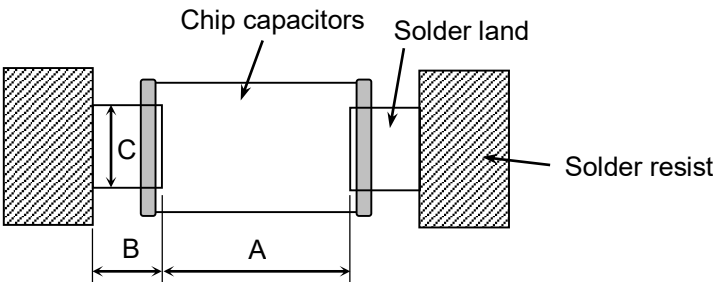
No.	Process	Condition												
3	Designing P.C.board	<p>The amount of solder at the terminations has a direct effect on the reliability of the capacitors.</p> <ol style="list-style-type: none"> <li>1) The greater the amount of solder, the higher the stress on the chip capacitors, and the more likely that it will break. When designing a P.C.board, determine the shape and size of the solder lands to have proper amount of solder on the terminations.</li> <li>2) Avoid using common solder land for multiple terminations and provide individual solder land for each terminations.</li> <li>3) Size and recommended land dimensions.</li> </ol> <div style="text-align: center;">  </div> <p>Reflow soldering (mm)</p> <table border="1" data-bbox="587 929 1369 1131"> <thead> <tr> <th>Case size Symbol</th> <th>CNC5 (CC1206)</th> <th>CNC6 (CC1210)</th> </tr> </thead> <tbody> <tr> <td>A</td> <td>2.0 ~ 2.4</td> <td>2.0 ~ 2.4</td> </tr> <tr> <td>B</td> <td>1.0 ~ 1.2</td> <td>1.0 ~ 1.2</td> </tr> <tr> <td>C</td> <td>1.1 ~ 1.6</td> <td>1.9 ~ 2.5</td> </tr> </tbody> </table>	Case size Symbol	CNC5 (CC1206)	CNC6 (CC1210)	A	2.0 ~ 2.4	2.0 ~ 2.4	B	1.0 ~ 1.2	1.0 ~ 1.2	C	1.1 ~ 1.6	1.9 ~ 2.5
Case size Symbol	CNC5 (CC1206)	CNC6 (CC1210)												
A	2.0 ~ 2.4	2.0 ~ 2.4												
B	1.0 ~ 1.2	1.0 ~ 1.2												
C	1.1 ~ 1.6	1.9 ~ 2.5												

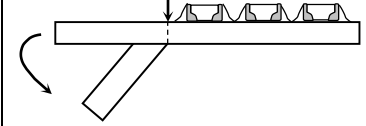
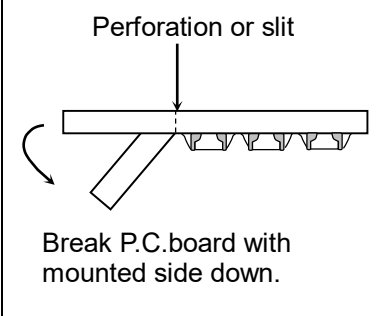
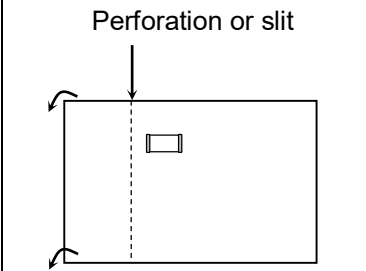
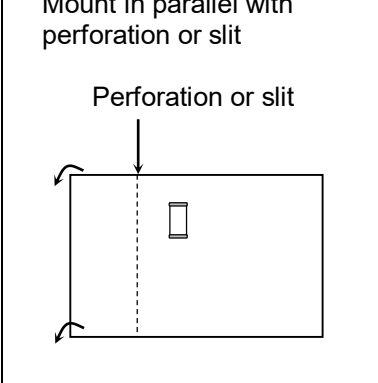
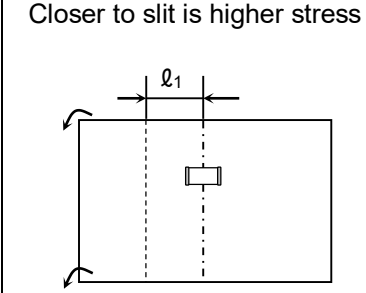
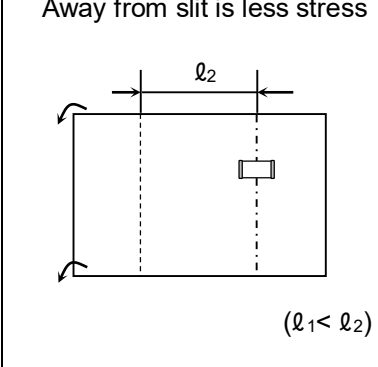
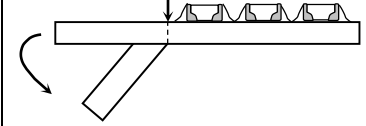
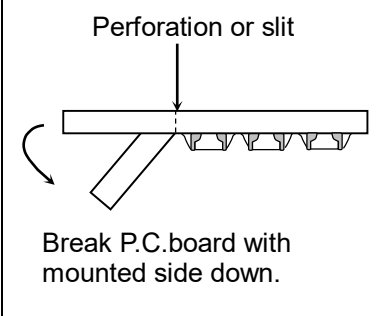
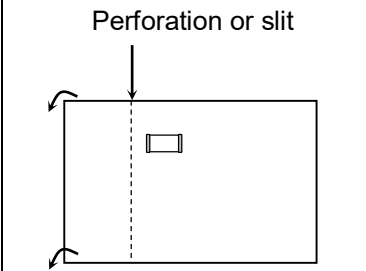
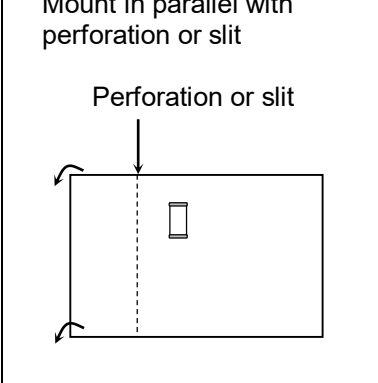
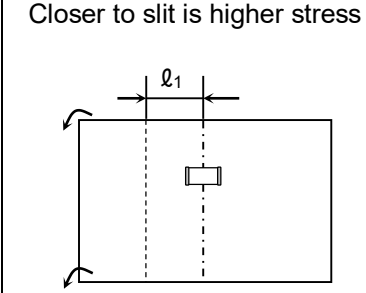
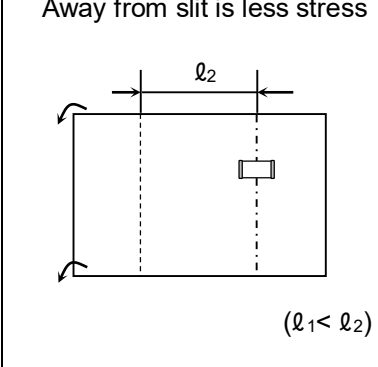
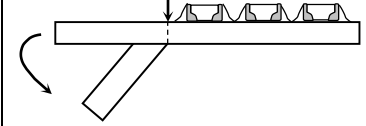
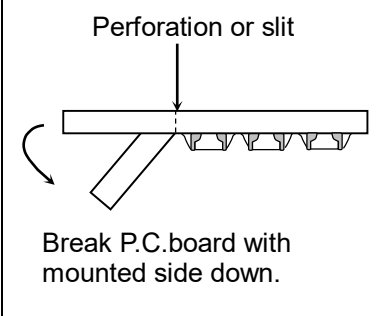
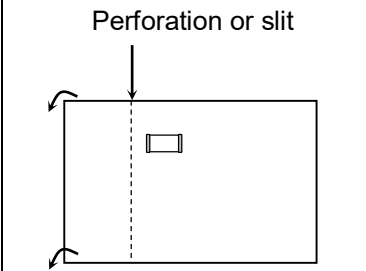
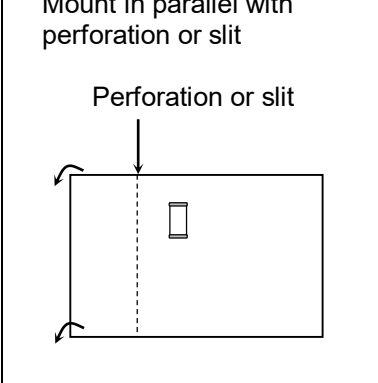
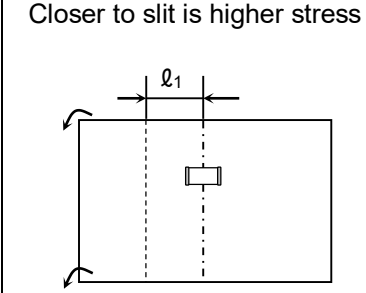
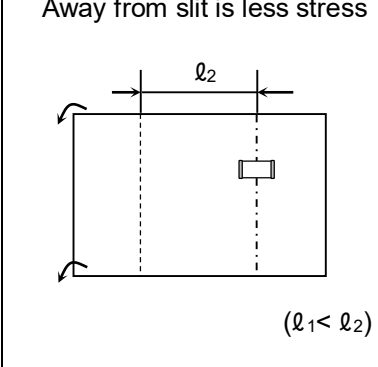

No.	Process	Condition												
3	Designing P.C.board	<p>4) Recommended chip capacitors layout is as following.</p> <table border="1" style="width: 100%; border-collapse: collapse;"> <thead> <tr> <th style="width: 20%;"></th> <th style="width: 40%;">Disadvantage against bending stress</th> <th style="width: 40%;">Advantage against bending stress</th> </tr> </thead> <tbody> <tr> <td style="text-align: center; vertical-align: middle;">Mounting face</td> <td style="text-align: center;"> <p>Perforation or slit</p>  <p>Break P.C.board with mounted side up.</p> </td> <td style="text-align: center;"> <p>Perforation or slit</p>  <p>Break P.C.board with mounted side down.</p> </td> </tr> <tr> <td style="text-align: center; vertical-align: middle;">Chip arrangement (Direction)</td> <td style="text-align: center;"> <p>Perforation or slit</p>  </td> <td style="text-align: center;"> <p>Perforation or slit</p>  </td> </tr> <tr> <td style="text-align: center; vertical-align: middle;">Distance from slit</td> <td style="text-align: center;"> <p>Closer to slit is higher stress</p>  <p><math>(l_1 &lt; l_2)</math></p> </td> <td style="text-align: center;"> <p>Away from slit is less stress</p>  <p><math>(l_1 &lt; l_2)</math></p> </td> </tr> </tbody> </table>		Disadvantage against bending stress	Advantage against bending stress	Mounting face	<p>Perforation or slit</p>  <p>Break P.C.board with mounted side up.</p>	<p>Perforation or slit</p>  <p>Break P.C.board with mounted side down.</p>	Chip arrangement (Direction)	<p>Perforation or slit</p> 	<p>Perforation or slit</p> 	Distance from slit	<p>Closer to slit is higher stress</p>  <p><math>(l_1 &lt; l_2)</math></p>	<p>Away from slit is less stress</p>  <p><math>(l_1 &lt; l_2)</math></p>
	Disadvantage against bending stress	Advantage against bending stress												
Mounting face	<p>Perforation or slit</p>  <p>Break P.C.board with mounted side up.</p>	<p>Perforation or slit</p>  <p>Break P.C.board with mounted side down.</p>												
Chip arrangement (Direction)	<p>Perforation or slit</p> 	<p>Perforation or slit</p> 												
Distance from slit	<p>Closer to slit is higher stress</p>  <p><math>(l_1 &lt; l_2)</math></p>	<p>Away from slit is less stress</p>  <p><math>(l_1 &lt; l_2)</math></p>												

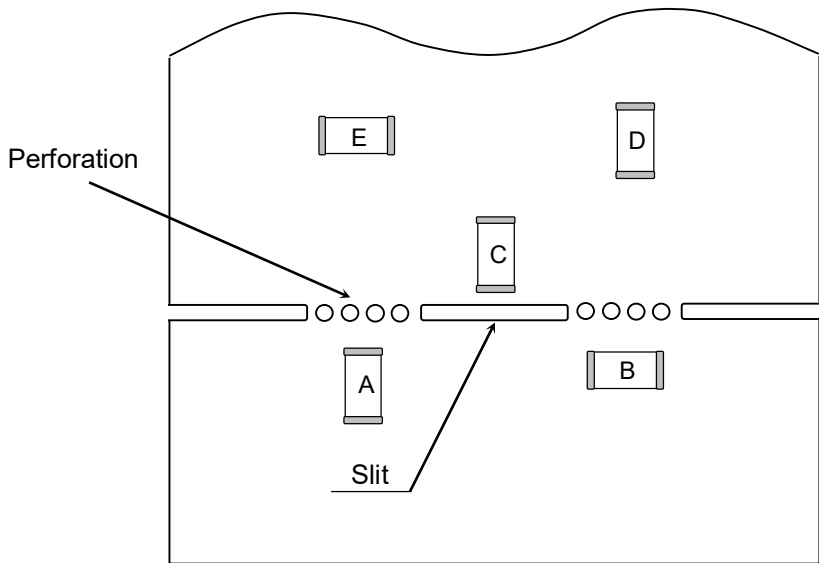
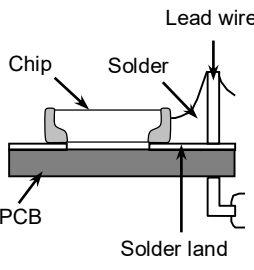
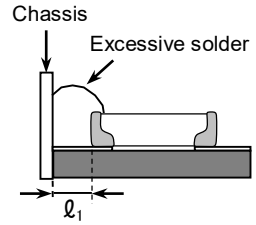
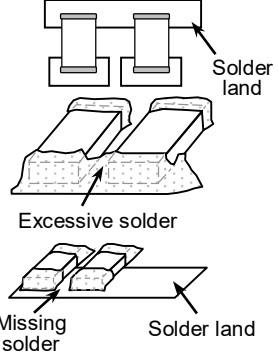
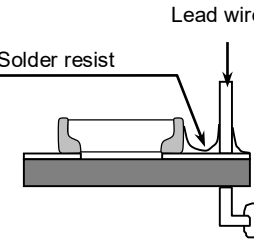
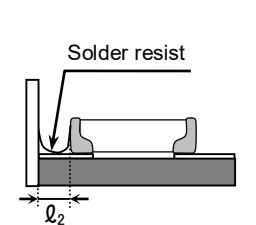
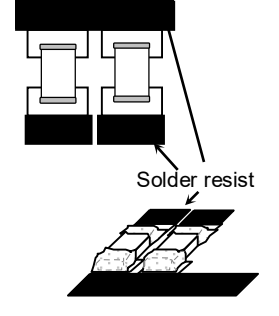
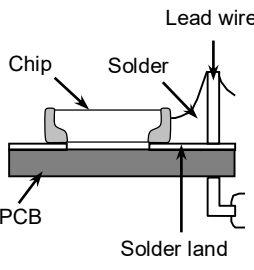
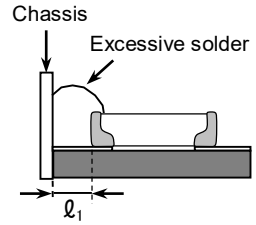
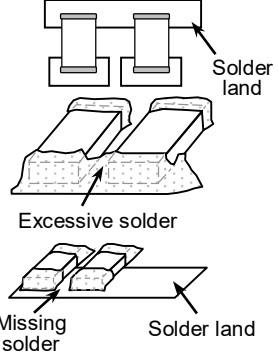
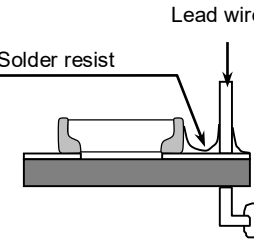
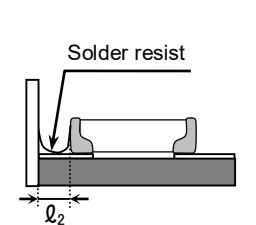
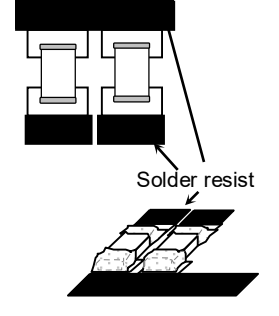
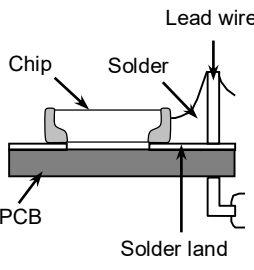
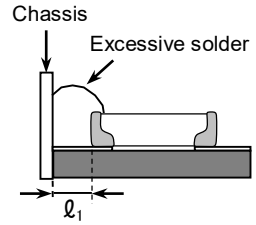
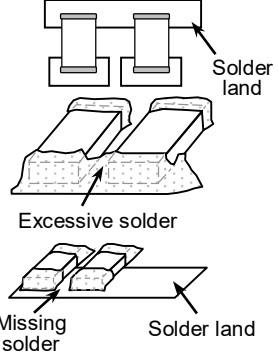
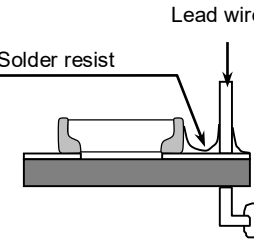
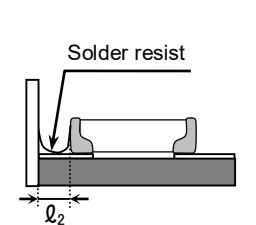
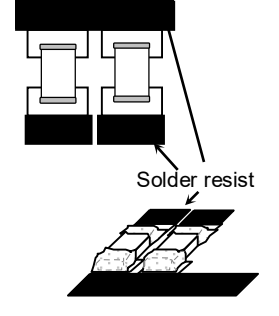

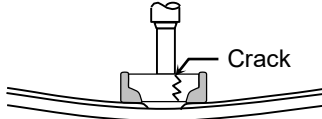
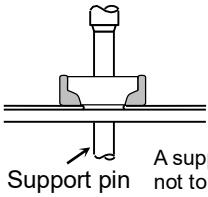
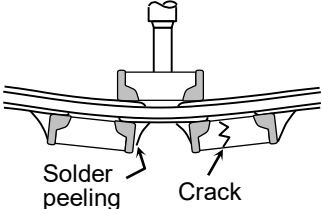
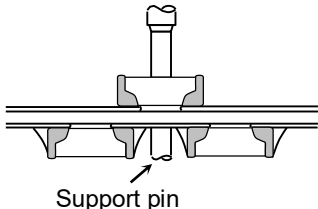
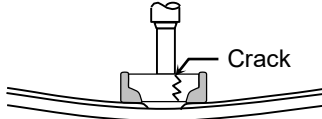
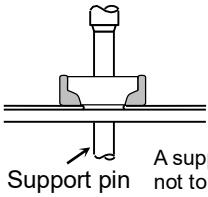
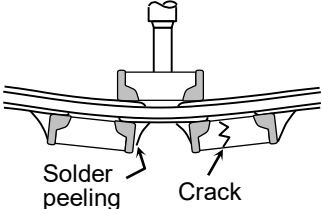
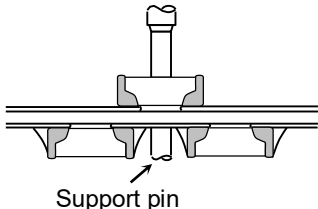
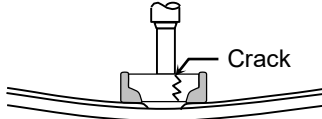
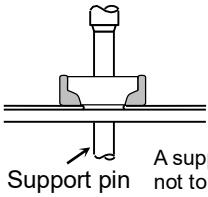
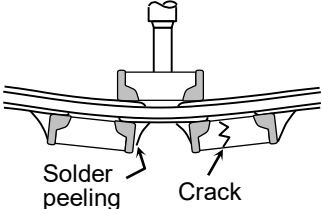
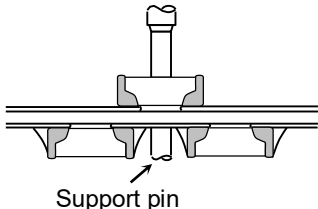
No.	Process	Condition												
3	Designing P.C.board	<p>5) Mechanical stress varies according to location of chip capacitors on the P.C.board.</p>  <p>Stress force  <math>A &gt; B &gt; E</math>  <math>A &gt; D &gt; E</math>  <math>A &gt; C</math></p> <p>When dividing printed wiring boards, the intensities of mechanical stress applied to capacitors are different according to each dividing method in the order of : Push-back &lt; Slit &lt; V-groove &lt; Perforation. Therefore consider not only position of capacitors, but also the way of the dividing the printed wiring boards.</p> <p>6) Layout recommendation</p> <table border="1" data-bbox="391 1041 1497 1960"> <thead> <tr> <th data-bbox="391 1041 555 1160">Example</th> <th data-bbox="555 1041 858 1160">Use of common solder land</th> <th data-bbox="858 1041 1165 1160">Soldering with chassis</th> <th data-bbox="1165 1041 1497 1160">Use of common solder land with other SMD</th> </tr> </thead> <tbody> <tr> <td data-bbox="391 1160 555 1541">Need to avoid</td> <td data-bbox="555 1160 858 1541">  </td> <td data-bbox="858 1160 1165 1541">  </td> <td data-bbox="1165 1160 1497 1541">  </td> </tr> <tr> <td data-bbox="391 1541 555 1960">Recommen Solder land - dation</td> <td data-bbox="555 1541 858 1960">  </td> <td data-bbox="858 1541 1165 1960">  <p><math>l_2 &gt; l_1</math></p> </td> <td data-bbox="1165 1541 1497 1960">  </td> </tr> </tbody> </table>	Example	Use of common solder land	Soldering with chassis	Use of common solder land with other SMD	Need to avoid				Recommen Solder land - dation		 <p><math>l_2 &gt; l_1</math></p>	
Example	Use of common solder land	Soldering with chassis	Use of common solder land with other SMD											
Need to avoid														
Recommen Solder land - dation		 <p><math>l_2 &gt; l_1</math></p>												

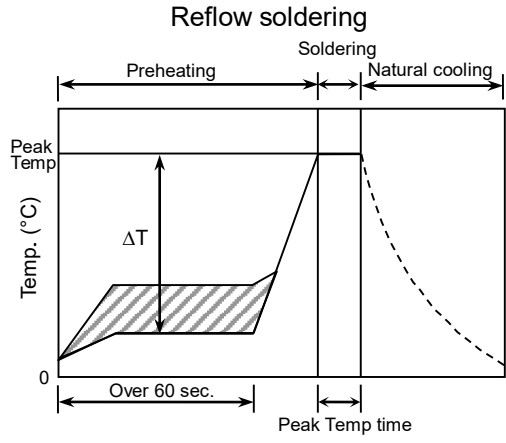
No.	Process	Condition									
4	Mounting	<p>4-1. Stress from mounting head If the mounting head is adjusted too low, it may induce excessive stress in the chip capacitors to result in cracking. Please take following precautions.</p> <ol style="list-style-type: none"> <li>1) Adjust the bottom dead center of the mounting head to reach on the P.C.board surface and not press it.</li> <li>2) Adjust the mounting head pressure to be 1 to 3N of static weight.</li> <li>3) To minimize the impact energy from mounting head, it is important to provide support from the bottom side of the P.C.board. See following examples.</li> </ol> <table border="1" data-bbox="496 573 1449 1214"> <thead> <tr> <th data-bbox="496 573 678 618"></th> <th data-bbox="678 573 1074 618">Not recommended</th> <th data-bbox="1074 573 1449 618">Recommended</th> </tr> </thead> <tbody> <tr> <td data-bbox="496 618 678 954">Single sided mounting</td> <td data-bbox="678 618 1074 954">  <p>Crack</p> </td> <td data-bbox="1074 618 1449 954">  <p>Support pin A support pin is not to be underneath the capacitor.</p> </td> </tr> <tr> <td data-bbox="496 954 678 1214">Double-sides mounting</td> <td data-bbox="678 954 1074 1214">  <p>Solder peeling Crack</p> </td> <td data-bbox="1074 954 1449 1214">  <p>Support pin</p> </td> </tr> </tbody> </table> <p>When the centering jaw is worn out, it may give mechanical impact on the capacitors to cause crack. Please control the close up dimension of the centering jaw and provide sufficient preventive maintenance and replacement of it.</p>		Not recommended	Recommended	Single sided mounting	 <p>Crack</p>	 <p>Support pin A support pin is not to be underneath the capacitor.</p>	Double-sides mounting	 <p>Solder peeling Crack</p>	 <p>Support pin</p>
	Not recommended	Recommended									
Single sided mounting	 <p>Crack</p>	 <p>Support pin A support pin is not to be underneath the capacitor.</p>									
Double-sides mounting	 <p>Solder peeling Crack</p>	 <p>Support pin</p>									

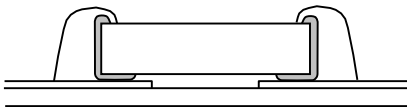
No.	Process	Condition											
5	Soldering	<p>5-1. Flux selection</p> <p>Flux can seriously affect the performance of capacitors. Confirm the following to select the appropriate flux.</p> <ol style="list-style-type: none"> <li>1) It is recommended to use a mildly activated rosin flux (less than 0.1wt% chlorine). Strong flux is not recommended.</li> <li>2) Excessive flux must be avoided. Please provide proper amount of flux.</li> <li>3) When water-soluble flux is used, enough washing is necessary.</li> </ol> <p>5-2. Recommended soldering profile : Reflow method Refer to the following temperature profile at Reflow soldering.</p> <div style="text-align: center;"> <p>Reflow soldering</p>  </div> <p>5-3. Recommended soldering peak temp and peak temp duration Pb free solder is recommended, but if Sn-37Pb must be used, refer to below.</p> <table border="1" data-bbox="667 1144 1257 1379"> <thead> <tr> <th rowspan="2" style="text-align: center;">Temp./Duration Solder</th> <th colspan="2" style="text-align: center;">Reflow soldering</th> </tr> <tr> <th style="text-align: center;">Peak temp(°C)</th> <th style="text-align: center;">Duration(sec.)</th> </tr> </thead> <tbody> <tr> <td style="text-align: center;">Lead Free Solder</td> <td style="text-align: center;">260 max.</td> <td style="text-align: center;">10 max.</td> </tr> <tr> <td style="text-align: center;">Sn-Pb Solder</td> <td style="text-align: center;">230 max.</td> <td style="text-align: center;">20 max.</td> </tr> </tbody> </table> <p>Recommended solder compositions Lead Free Solder : Sn-3.0Ag-0.5Cu</p>	Temp./Duration Solder	Reflow soldering		Peak temp(°C)	Duration(sec.)	Lead Free Solder	260 max.	10 max.	Sn-Pb Solder	230 max.	20 max.
Temp./Duration Solder	Reflow soldering												
	Peak temp(°C)	Duration(sec.)											
Lead Free Solder	260 max.	10 max.											
Sn-Pb Solder	230 max.	20 max.											

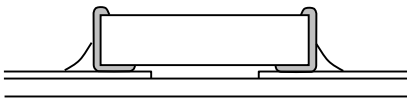
No.	Process	Condition									
5	Soldering	<p>5-4. Avoiding thermal shock</p> <p>1) Preheating condition</p> <table border="1" data-bbox="555 248 1289 392"> <thead> <tr> <th data-bbox="555 248 783 297">Soldering</th> <th data-bbox="783 248 1026 297">Case size</th> <th data-bbox="1026 248 1289 297">Temp. (°C)</th> </tr> </thead> <tbody> <tr> <td data-bbox="555 297 783 347">Reflow soldering</td> <td data-bbox="783 297 1026 347">CNC5(CC1206)</td> <td data-bbox="1026 297 1289 347"><math>\Delta T \leq 150</math></td> </tr> <tr> <td data-bbox="555 347 783 392"></td> <td data-bbox="783 347 1026 392">CNC6(CC1210)</td> <td data-bbox="1026 347 1289 392"><math>\Delta T \leq 130</math></td> </tr> </tbody> </table> <p>2) Cooling condition Natural cooling using air is recommended. If the chips are dipped into a solvent for cleaning, the temperature difference (<math>\Delta T</math>) must be less than 100°C.</p> <p>5-5. Amount of solder Excessive solder will induce higher tensile force in chip capacitors when temperature changes and it may result in chip cracking. In sufficient solder may detach the capacitors from the P.C.board.</p> <div style="display: flex; justify-content: space-between; align-items: flex-start;"> <div data-bbox="528 734 655 797" style="width: 30%;">Excessive solder</div> <div data-bbox="699 714 1107 819" style="width: 35%; text-align: center;">  </div> <div data-bbox="1129 719 1430 813" style="width: 30%;">Higher tensile force in chip capacitors to cause crack</div> </div> <hr/> <div style="display: flex; justify-content: space-between; align-items: center;"> <div data-bbox="528 904 651 936" style="width: 30%;">Adequate</div> <div data-bbox="699 857 1107 972" style="width: 35%; text-align: center;">  </div> </div> <hr/> <div style="display: flex; justify-content: space-between; align-items: flex-start;"> <div data-bbox="523 1043 660 1106" style="width: 30%;">Insufficient solder</div> <div data-bbox="699 1037 1107 1133" style="width: 35%; text-align: center;">  </div> <div data-bbox="1129 1014 1430 1133" style="width: 30%;">Low robustness may cause contact failure or chip capacitors come off the P.C.board.</div> </div> <hr/> <p>5-6. Sn-Zn solder Sn-Zn solder affects product reliability. Please contact TDK in advance when utilize Sn-Zn solder.</p> <p>5-7. Countermeasure for tombstone The misalignment between the mounted positions of the capacitors and the land patterns should be minimized. The tombstone phenomenon may occur especially the capacitors are mounted (in longitudinal direction) in the same direction of the reflow soldering. (Refer to JEITA RCR-2335C Annex A (Informative) Recommendations to prevent the tombstone phenomenon)</p>	Soldering	Case size	Temp. (°C)	Reflow soldering	CNC5(CC1206)	$\Delta T \leq 150$		CNC6(CC1210)	$\Delta T \leq 130$
Soldering	Case size	Temp. (°C)									
Reflow soldering	CNC5(CC1206)	$\Delta T \leq 150$									
	CNC6(CC1210)	$\Delta T \leq 130$									

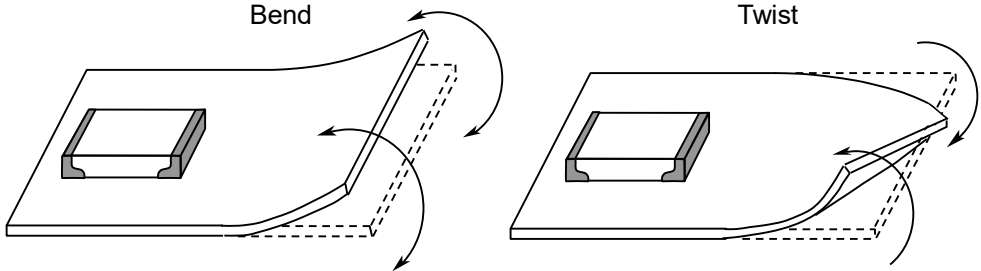
No.	Process	Condition
6	Cleaning	<p>1) If an unsuitable cleaning fluid is used, flux residue or some foreign articles may stick to chip capacitors surface to deteriorate especially the insulation resistance.</p> <p>2) If cleaning condition is not suitable, it may damage the chip capacitors.</p> <p>2)-1. Insufficient washing</p> <p>(1) Terminal electrodes may corrode by Halogen in the flux.</p> <p>(2) Halogen in the flux may adhere on the surface of capacitors, and lower the insulation resistance.</p> <p>(3) Water soluble flux has higher tendency to have above mentioned problems (1) and (2).</p> <p>2)-2. Excessive washing When ultrasonic cleaning is used, excessively high ultrasonic energy output can affect the connection between the ceramic chip capacitor's body and the terminal electrode. To avoid this, following is the recommended condition.</p> <p style="text-align: center;">Power : 20W/l max. Frequency : 40kHz max. Washing time : 5 minutes max.</p> <p>2)-3. If the cleaning fluid is contaminated, density of Halogen increases, and it may bring the same result as insufficient cleaning.</p>
7	Coating and molding of the P.C.board	<p>1) This product contains Ag (Silver) as part of the middle layer of termination. To avoid electromigration of Ag under high temperature and humidity, and failures caused by corrosive gas, chip capacitors on P.C boards should be protected by moisture proof-sealing.</p> <p>2) When the P.C.board is coated, please verify the quality influence on the product.</p> <p>3) Please verify carefully that there is no harmful decomposing or reaction gas emission during curing which may damage the chip capacitors.</p> <p>4) Please verify the curing temperature.</p>
8	Handling after chip mounted ⚠ Caution	<p>1) Please pay attention not to bend or distort the P.C.board after soldering in handling otherwise the chip capacitors may crack.</p> <div style="text-align: center;">  </div>

No.	Process	Condition															
8	Handling after chip mounted ⚠ Caution	<p>2) Printed circuit board cropping should not be carried out by hand, but by using the proper tooling. Printed circuit board cropping should be carried out using a board cropping jig as shown in the following figure or a board cropping apparatus to prevent inducing mechanical stress on the board.</p> <p>(1) Example of a board cropping jig                      Recommended example: The board should be pushed from the back side, close to the cropping jig so that the board is not bent and the stress applied to the capacitor is compressive.                      Unrecommended example: If the pushing point is far from the cropping jig and the pushing direction is from the front side of the board, large tensile stress is applied to the capacitor, which may cause cracks.</p> <div style="display: flex; justify-content: space-around;"> <div data-bbox="462 571 758 840"> <p>Outline of jig</p> </div> <div data-bbox="758 571 1444 840"> <table border="1"> <thead> <tr> <th>Recommended</th> <th>Unrecommended</th> </tr> </thead> <tbody> <tr> <td> </td> <td> </td> </tr> </tbody> </table> </div> </div> <p>(2) Example of a board cropping machine</p> <p>An outline of a printed circuit board cropping machine is shown below. The top and bottom blades are aligned with one another along the lines with the V-grooves on printed circuit board when cropping the board.</p> <p>Unrecommended example: Misalignment of blade position between top and bottom, right and left, or front and rear blades may cause a crack in the capacitor.</p> <div style="display: flex; justify-content: space-around; margin-top: 20px;"> <div data-bbox="550 1164 925 1433"> <p>Outline of machine</p> </div> <div data-bbox="957 1164 1412 1422"> <p>Principle of operation</p> </div> </div> <div style="text-align: center; margin-top: 20px;"> <p>Cross-section diagram</p> </div> <table border="1" style="width: 100%; margin-top: 20px; text-align: center;"> <thead> <tr> <th rowspan="2">Recommended</th> <th colspan="3">Unrecommended</th> </tr> <tr> <th>Top-bottom misalignment</th> <th>Left-right misalignment</th> <th>Front-rear misalignment</th> </tr> </thead> <tbody> <tr> <td> </td> <td> </td> <td> </td> <td> </td> </tr> </tbody> </table>	Recommended	Unrecommended			Recommended	Unrecommended			Top-bottom misalignment	Left-right misalignment	Front-rear misalignment				
Recommended	Unrecommended																
Recommended	Unrecommended																
	Top-bottom misalignment	Left-right misalignment	Front-rear misalignment														

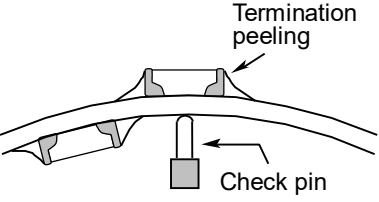
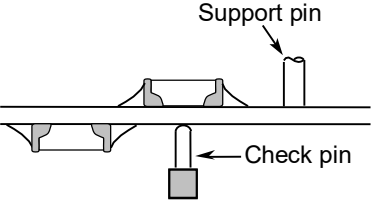
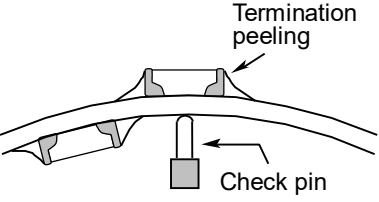
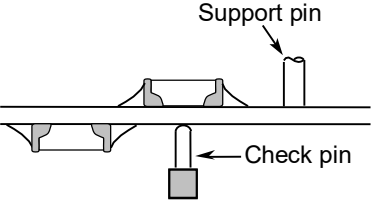
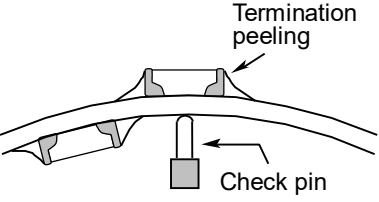
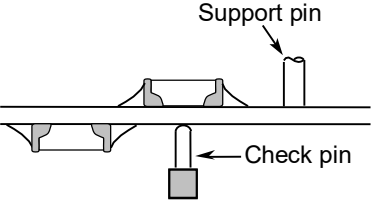
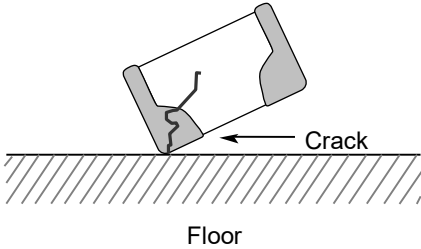
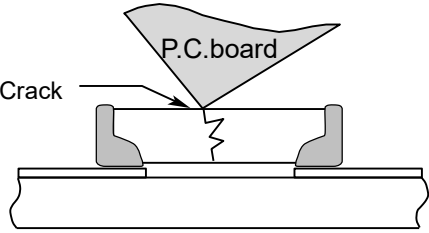
No.	Process	Condition						
8	Handling after chip mounted  Caution	<p data-bbox="491 197 1477 338">3) When functional check of the P.C.board is performed, check pin pressure tends to be adjusted higher for fear of loose contact. But if the pressure is excessive and bend the P.C.board, it may crack the chip capacitors or peel the terminations off. Please adjust the check pins not to bend the P.C.board.</p> <table border="1" data-bbox="491 398 1449 696"> <thead> <tr> <th data-bbox="491 398 630 456">Item</th> <th data-bbox="630 398 1046 456">Not recommended</th> <th data-bbox="1046 398 1449 456">Recommended</th> </tr> </thead> <tbody> <tr> <td data-bbox="491 456 630 696">Board bending</td> <td data-bbox="630 456 1046 696">  </td> <td data-bbox="1046 456 1449 696">  </td> </tr> </tbody> </table>	Item	Not recommended	Recommended	Board bending		
Item	Not recommended	Recommended						
Board bending								
9	Handling of loose chip capacitors	<p data-bbox="480 745 1477 835">1) If dropped the chip capacitors may crack. Once dropped do not use it. Especially, the large case sized chip capacitors are tendency to have cracks easily, so please handle with care.</p>  <p data-bbox="480 1093 1477 1160">2) Piling the P.C.board after mounting for storage or handling, the corner of the P.C. board may hit the chip capacitors of another board to cause crack.</p> 						
10	Capacitance aging	<p data-bbox="472 1451 1437 1541">The capacitors have aging in the capacitance. They may not be used in precision time constant circuit. In case of the time constant circuit, the evaluation should be done well.</p>						
11	Estimated life and estimated failure rate of capacitors	<p data-bbox="472 1585 1461 1731">As per the estimated life and the estimated failure rate depend on the temperature and the voltage. This can be calculated by the equation described in JEITA RCR-2335C Annex F(Informative) Calculation of the estimated lifetime and the estimated failure rate (Voltage acceleration coefficient : 3 multiplication rule, Temperature acceleration coefficient : 10°C rule)</p> <p data-bbox="472 1733 1453 1800">The failure rate can be decreased by reducing the temperature and the voltage but they will not be guaranteed.</p>						

No.	Process	Condition
12	Caution during operation of equipment	<ol style="list-style-type: none"> <li>1) A capacitor shall not be touched directly with bare hands during operation in order to avoid electric shock. Electric energy held by the capacitor may be discharged through the human body when touched with a bare hand. Even when the equipment is off, a capacitor may stay charged. The capacitor should be handled after being completely discharged using a resistor.</li> <li>2) The terminals of a capacitor shall not be short-circuited by any accidental contact with a conductive object. A capacitor shall not be exposed to a conductive liquid such as an acid or alkali solution. A conductive object or liquid, such as acid and alkali, between the terminals may lead to the breakdown of a capacitor due to short circuit</li> <li>3) Confirm that the environment to which the equipment will be exposed during transportation and operation meets the specified conditions. Do not to use the equipment in the following environments.               <ol style="list-style-type: none"> <li>(1) Environment where a capacitor is splattered with water or oil</li> <li>(2) Environment where a capacitor is exposed to direct sunlight</li> <li>(3) Environment where a capacitor is exposed to Ozone, ultraviolet rays or radiation</li> <li>(4) Environment where a capacitor exposed to corrosive gas(e.g. hydrogen sulfide, sulfur dioxide, chlorine. ammonia gas etc.)</li> <li>(5) Environment where a capacitor exposed to vibration or mechanical shock exceeding the specified limits.</li> <li>(6) Atmosphere change with causes condensation</li> </ol> </li> </ol>
13	Others  Caution	<p>The products listed on this specification sheet are intended for use in general electronic equipment (AV equipment, telecommunications equipment, home appliances, amusement equipment, computer equipment, personal equipment, office equipment, measurement equipment, industrial robots) under a normal operation and use condition.</p> <p>The products are not designed or warranted to meet the requirements of the applications listed below, whose performance and/or quality require a more stringent level of safety or reliability, or whose failure, malfunction or trouble could cause serious damage to society, person or property. Please understand that we are not responsible for any damage or liability caused by use of the products in any of the applications below or for any other use exceeding the range or conditions set forth in this specification sheet. If you intend to use the products in the applications listed below or if you have special requirements exceeding the range or conditions set forth in this specification, please contact us.</p> <ol style="list-style-type: none"> <li>(1) Aerospace/Aviation equipment</li> <li>(2) Transportation equipment (cars, electric trains, ships, etc.)</li> <li>(3) Medical equipment (Excepting Pharmaceutical Affairs Law classification Class1, 2)</li> <li>(4) Power-generation control equipment</li> <li>(5) Atomic energy-related equipment</li> <li>(6) Seabed equipment</li> <li>(7) Transportation control equipment</li> <li>(8) Public information-processing equipment</li> <li>(9) Military equipment</li> <li>(10) Electric heating apparatus, burning equipment</li> <li>(11) Disaster prevention/crime prevention equipment</li> <li>(12) Safety equipment</li> <li>(13) Other applications that are not considered general-purpose applications</li> </ol> <p>When designing your equipment even for general-purpose applications, you are kindly requested to take into consideration securing protection circuit/device or providing backup circuits in your equipment.</p>



## 12. TAPE PACKAGING SPECIFICATION

### 1. CONSTRUCTION AND DIMENSION OF TAPING

#### 1-1. Dimensions of carrier tape

Dimensions of plastic tape shall be according to Appendix 3.

#### 1-2. Bulk part and leader of taping

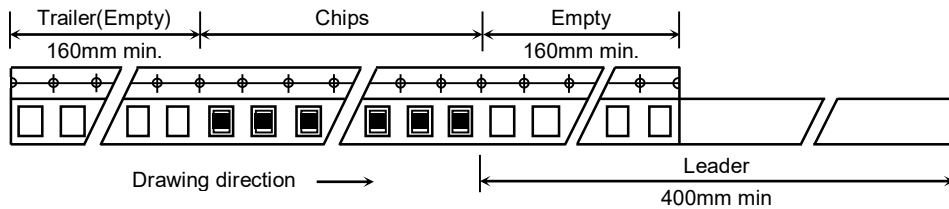

#### 1-3. Dimensions of reel

Dimensions of  $\varnothing 178$  reel shall be according to Appendix 4, 5.

Dimensions of  $\varnothing 330$  reel shall be according to Appendix 6, 7.

#### 1-4. Structure of taping

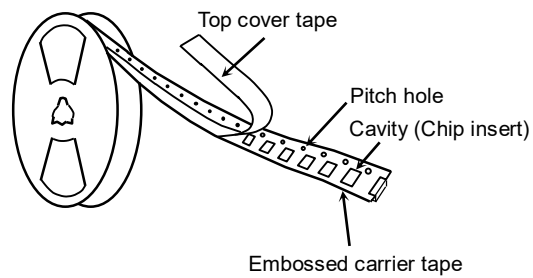

## 2. CHIP QUANTITY

Please refer to detail page on TDK web.

### 3. PERFORMANCE SPECIFICATIONS

#### 3-1. Fixing peeling strength (top cover tape)

$$0.05\text{N} < \text{Peeling strength} < 0.7\text{N}$$

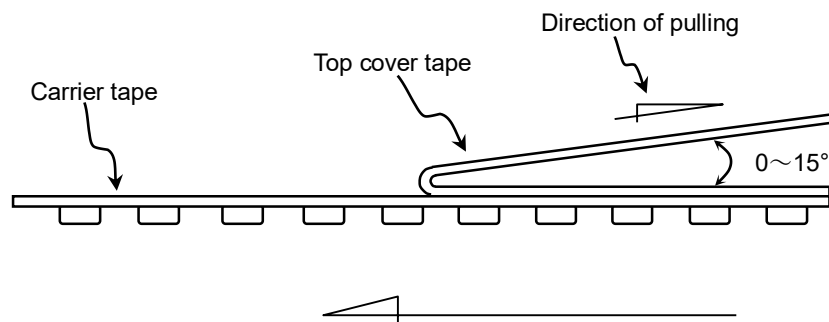

3-2. Carrier tape shall be flexible enough to be wound around a minimum radius of 30mm with components in tape.

3-3. The missing of components shall be less than 0.1%

3-4. Components shall not stick to fixing tape.

3-5. When removing the cover tape, there shall not be difficulties by unfitting clearance gap, burrs and crushes of cavities. Also the sprocket holes shall not be covered by absorbing dust into the suction nozzle.

### Appendix 3

#### Plastic Tape

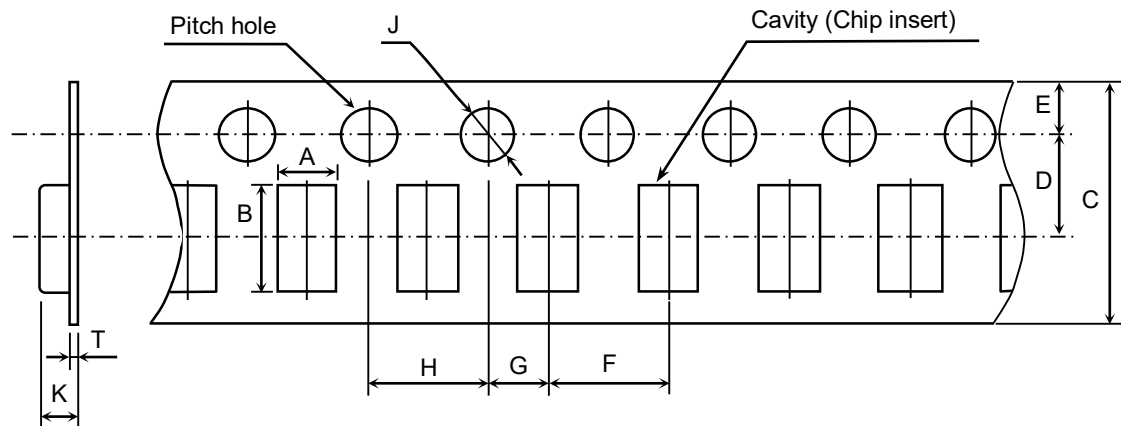

(Unit : mm)

Symbol Case size	A	B	C	D	E	F
CNC5 (CC1206)	( 1.90 )	( 3.50 )	8.00 ± 0.30	3.50 ± 0.05	1.75 ± 0.10	4.00 ± 0.10
CNC6 (CC1210)	( 2.90 )	( 3.60 )	12.0 ± 0.30	5.50 ± 0.05		
Symbol Case size	G	H	J	K	T	
CNC5 (CC1206)	2.00 ± 0.05	4.00 ± 0.10	∅1.50 <sup>+0.10</sup> <sub>0</sub>	2.50 max.	0.60 max.	
CNC6 (CC1210)				3.40 max.		

( ) Reference value.

## Appendix 4

Dimensions of reel (Material : Polystyrene)  
CNC5

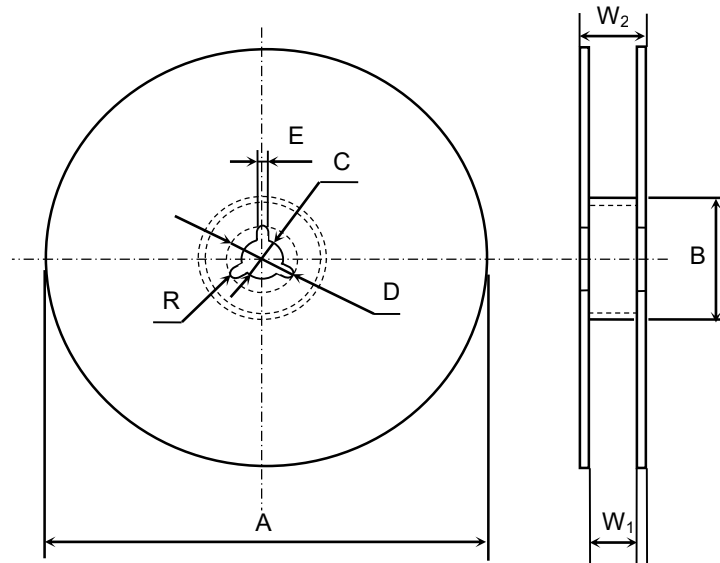

(Unit : mm)

Symbol	A	B	C	D	E	W <sub>1</sub>
Dimension	$\varnothing 178 \pm 2.0$	$\varnothing 60 \pm 2.0$	$\varnothing 13 \pm 0.5$	$\varnothing 21 \pm 0.8$	$2.0 \pm 0.5$	$9.0 \pm 0.3$
Symbol	W <sub>2</sub>	R				
Dimension	$13.0 \pm 1.4$	1.0				

## Appendix 5

Dimensions of reel (Material : Polystyrene)  
CNC6

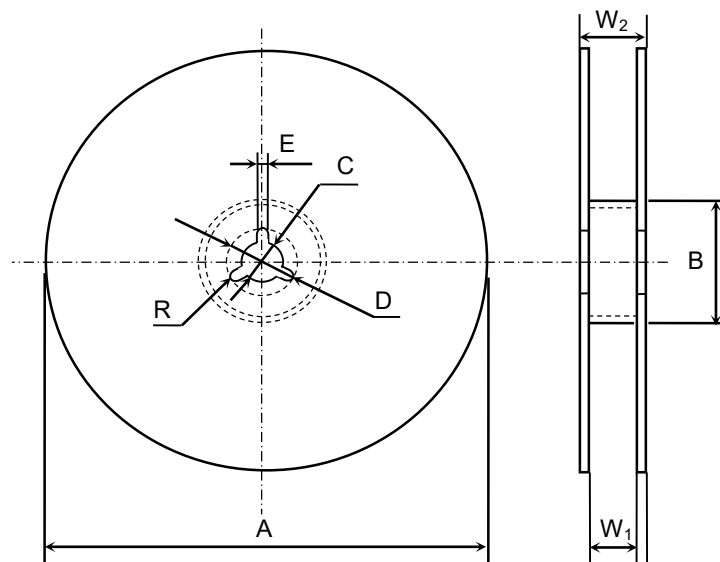

(Unit : mm)

Symbol	A	B	C	D	E	W <sub>1</sub>
Dimension	$\varnothing 178 \pm 2.0$	$\varnothing 60 \pm 2.0$	$\varnothing 13 \pm 0.5$	$\varnothing 21 \pm 0.8$	$2.0 \pm 0.5$	$13.0 \pm 0.3$
Symbol	W <sub>2</sub>	R				
Dimension	$17.0 \pm 1.4$	1.0				

## Appendix 6

Dimensions of reel (Material : Polystyrene)  
CNC5

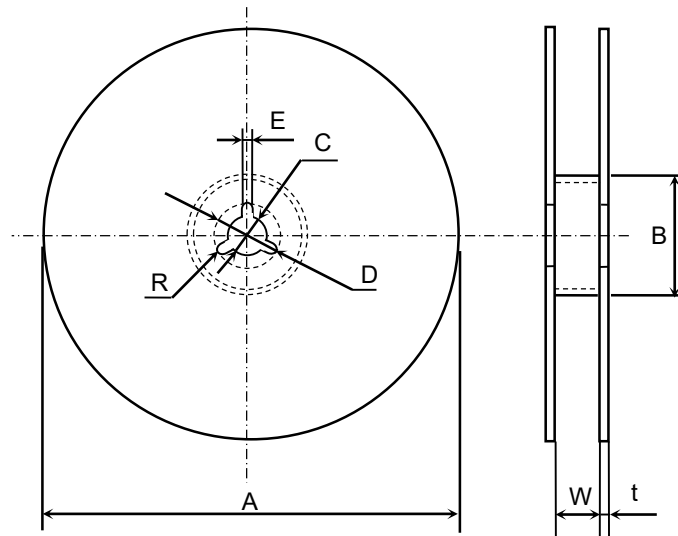

(Unit : mm)

Symbol	A	B	C	D	E	W
Dimension	∅382 max. (Nominal ∅330)	∅50 min.	∅13 ± 0.5	∅21 ± 0.8	2.0 ± 0.5	10.0 ± 1.5
Symbol	t	R				
Dimension	2.0 ± 0.5	1.0				

## Appendix 7

Dimensions of reel (Material : Polystyrene)  
CNC6

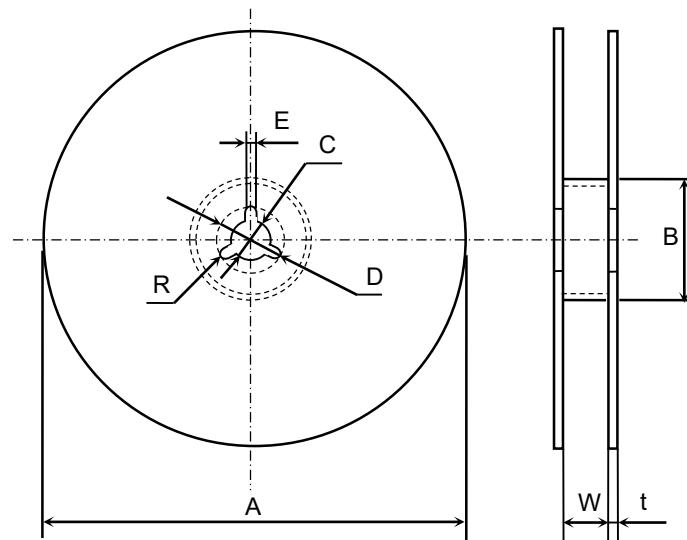

(Unit : mm)

Symbol	A	B	C	D	E	W
Dimension	∅382 max. (Nominal ∅330)	∅50 min.	∅13 ± 0.5	∅21 ± 0.8	2.0 ± 0.5	14.0 ± 1.5
Symbol	t	R				
Dimension	2.0 ± 0.5	1.0				