

● Description

The KPC825 series consist of a photodarlington optically coupled to a gallium arsenide infrared-emitting diode in a 8-pin DIP package and available in wide-lead spacing and SMD option. The input-output isolation voltage is rated at 5000 Vrms.

● Features

1. Current transfer ratio
(CTR : Min. 600% at $I_F=1\text{mA}$ $V_{CE}=2\text{V}$)
2. High isolation voltage between input and output
(Viso : 5000Vrms)
3. Compact dual-in-line package
4. Pb free and RoHS compliant
5. MSL class 1
6. Agency Approvals
 - UL Approved (No. E169586): UL1577
 - c-UL Approved (No. E169586)
 - VDE Approved (No. 40005500): DIN EN60747-5-5
 - FIMKO Approved: EN62368-1, EN60601-1

● Applications

- System appliances, measuring instruments
- Industrial robots
- Copiers, automatic vending machines
- Signal transmission between circuits of different potentials and impedances

● Schematic

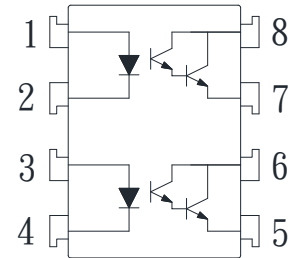

- 1 、 3. Anode
- 2 、 4. Cathode
- 5 、 7. Emitter
- 6 、 8. Collector

● **Outside Dimension**

Unit : mm

1. Dual-in-line type.

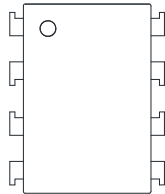

KPC825

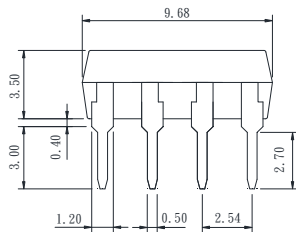
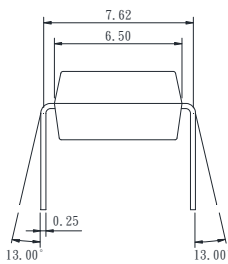

2. Surface mount type.

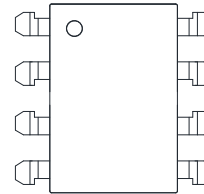

KPC825S

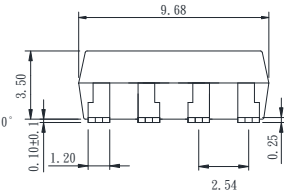
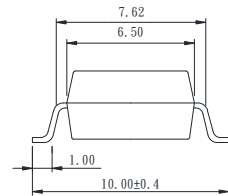

3. Long creepage distance type

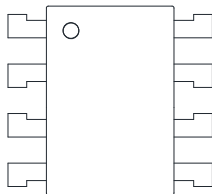

KPC825H

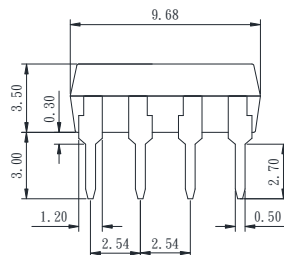
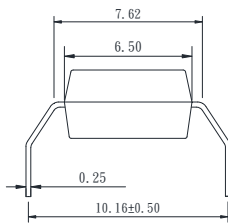

4. Long creepage distance for surface mount type.

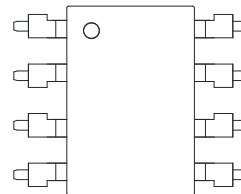

KPC825L

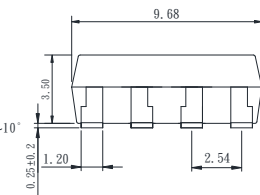
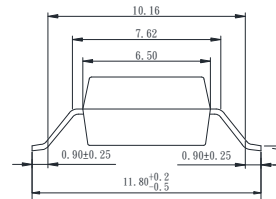

TOLERANCE : ±0.2mm

● **Device Marking**

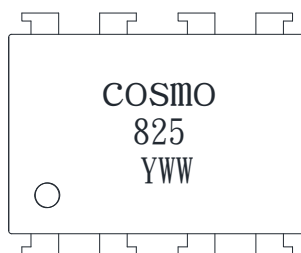

Notes:

COSMO
825
YWW

Y: Year code / WW: Week code

● Absolute Maximum Ratings

(Ta=25°C)

Parameter		Symbol	Rating	Unit
Input	Forward current	I_F	50	mA
	Peak forward current	I_{FM}	1	A
	Reverse voltage	V_R	6	V
	Power dissipation	P_D	70	mW
Output	Collector-emitter voltage	V_{CEO}	35	V
	Emitter-collector voltage	V_{ECO}	6	V
	Collector current	I_C	80	mA
	Collector power dissipation	P_C	150	mW
Total power dissipation		P_{tot}	200	mW
Isolation voltage 1 minute		V_{iso}	5000	Vrms
Operating temperature		T_{opr}	-55 to +115	°C
Storage temperature		T_{stg}	-55 to +125	°C
Soldering temperature 10 seconds		T_{sol}	260	°C

● Electro-optical Characteristics

(Ta=25°C)

Parameter		Symbol	Conditions	Min.	Typ.	Max.	Unit
Input	Forward voltage	V_F	$I_F=20mA$	-	1.2	1.4	V
	Peak forward voltage	V_{FM}	$I_{FM}=0.5A$	-	-	3.5	V
	Reverse current	I_R	$V_R=4V$	-	-	10	uA
	Terminal capacitance	C_t	$V=0, f=1KHz$	-	30	250	pF
Output	Collector dark current	I_{CEO}	$V_{CE}=10V, I_F=0$	-	-	1.0	μA
Transfer characteristics	Current transfer ratio	CTR	$I_F=1mA, V_{CE}=2V$	600	-	7500	%
	Collector-emitter saturation	$V_{CE(sat)}$	$I_F=20mA, I_C=5mA$	-	0.8	1.0	V
	Isolation resistance	R_{iso}	DC500V	5×10^{10}	-	-	Ω
	Floating capacitance	C_f	$V=0, f=1MHz$	-	0.6	1.0	pF
	Cut-off frequency	f_C	$V_{CC}=5V, I_C=20mA, R_L=100\Omega$	1	6	-	KHz
	Response time (Rise)	t_r	$V_{CE}=2V, I_C=20mA, R_L=100\Omega$	-	5	40	μs
	Response time (Fall)	t_f		-	60	100	μs

Classification table of current transfer ratio is shown below.

KPC825 Model No.	CTR (%)
KPC825 E	600 ~ 7500

Fig.1 Current Transfer Ratio vs. Forward Current

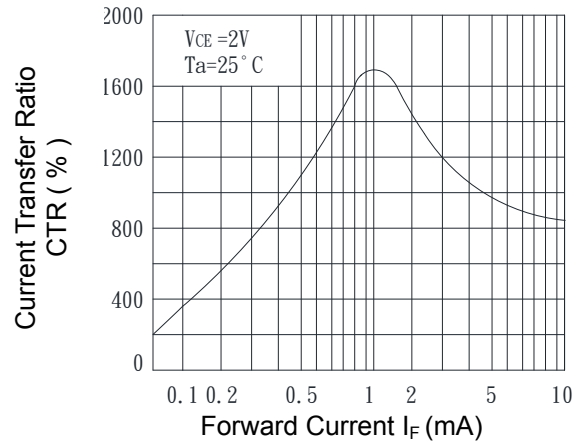

Fig.2 Collector Power Dissipation vs. Ambient Temperature

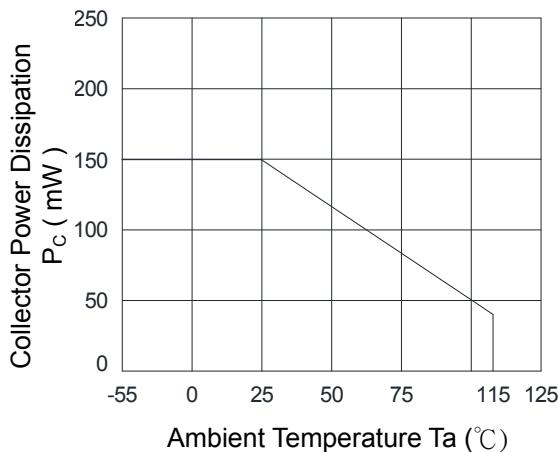

Fig.3 Collector Dark Current vs. Ambient Temperature

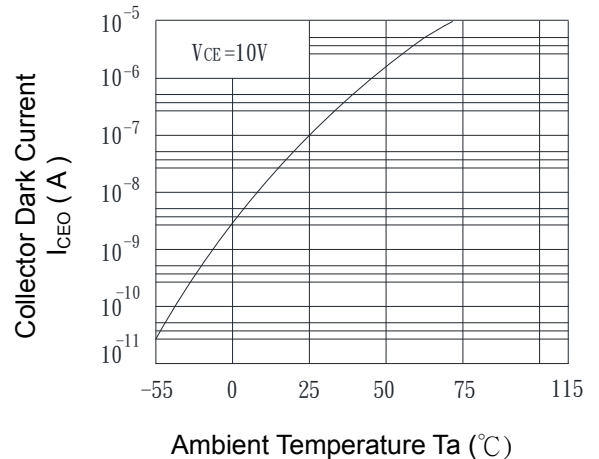

Fig.4 Forward Current vs. Ambient Temperature

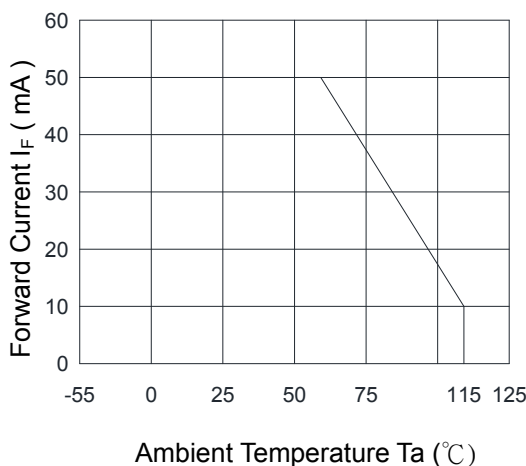

Fig.5 Forward Current vs. Forward Voltage

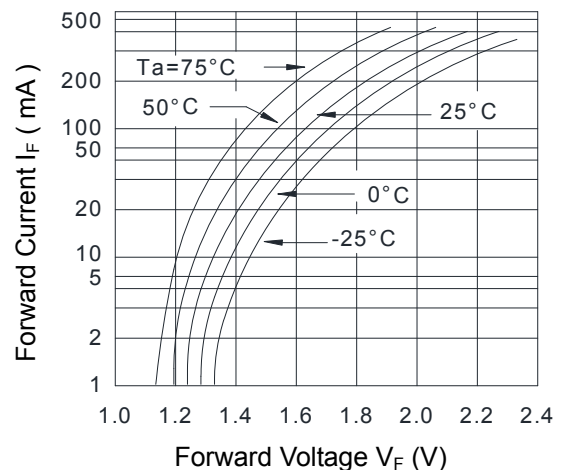

Fig.6 Collector Current vs. Collector-Emitter Voltage

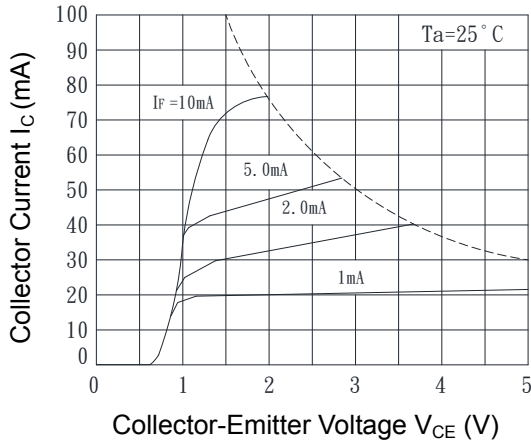

Fig.7 Relative Current Transfer Ratio vs. Ambient Temperature

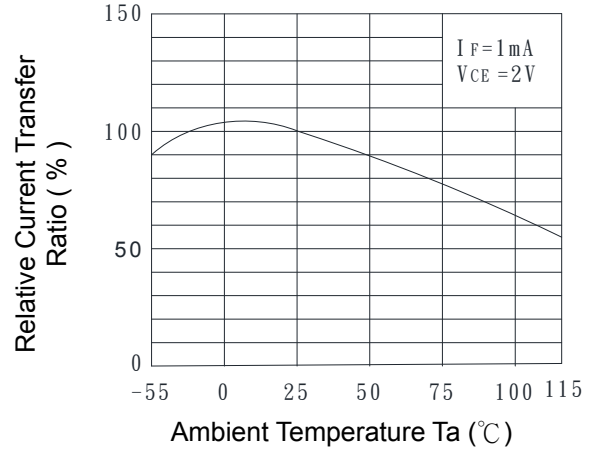

Fig.8 Collector-Emitter Saturation Voltage vs. Forward Current

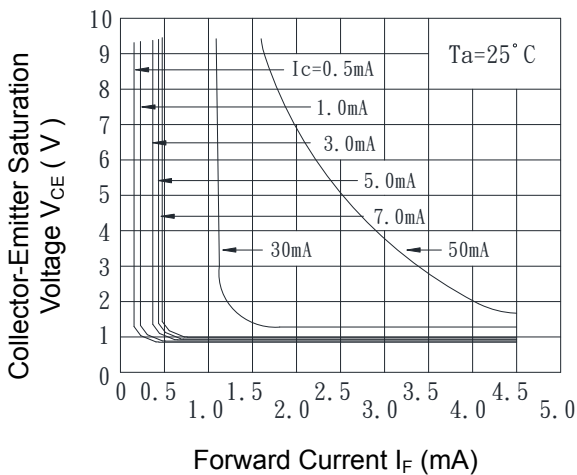

Fig.9 Collector-Emitter Saturation Voltage vs. Ambient Temperature

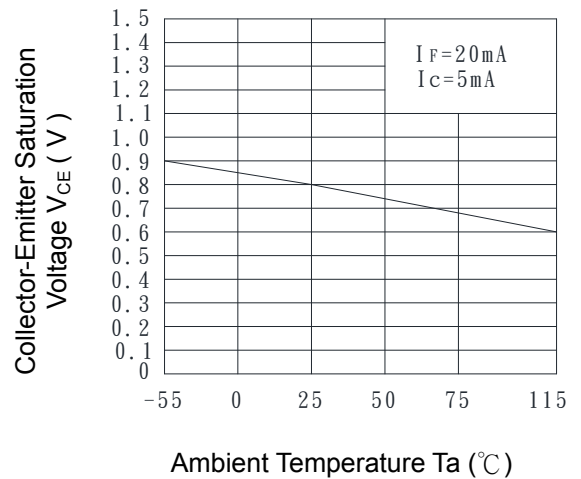
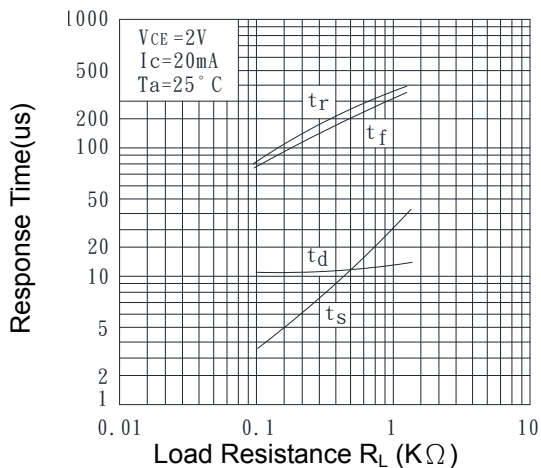
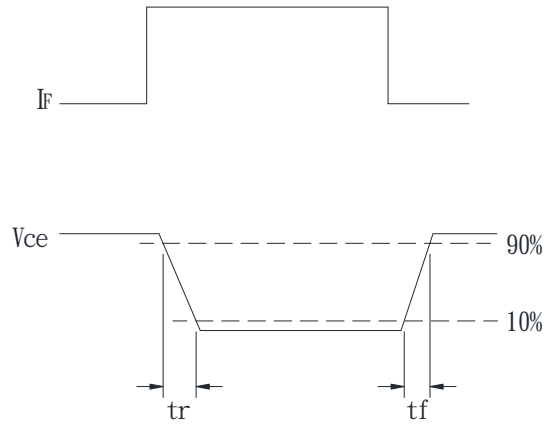
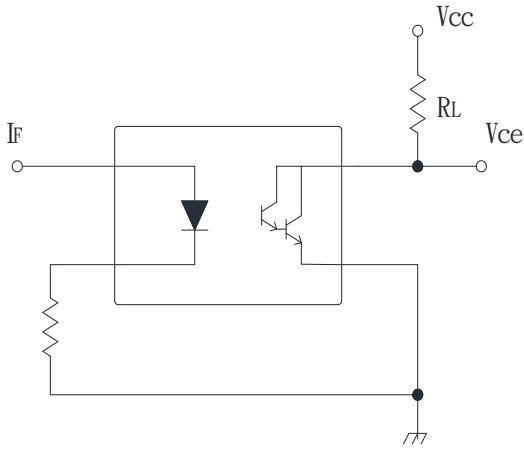

Fig.10 Response Time vs. Load Resistance



● **Test Circuit for Response Time**



● **Recommended Soldering Conditions**

(a) Infrared reflow soldering :

- Peak reflow soldering : 260°C or below (package surface temperature)
- Time of peak reflow temperature : 10 sec
- Time of temperature higher than 230°C : 30-60 sec
- Time to preheat temperature from 180~190°C : 60-120 sec
- Time(s) of reflow : Two
- Flux : Rosin flux containing small amount of chlorine (The flux with a maximum chlorine content of 0.2 Wt% is recommended.)

Recommended Temperature Profile of Infrared Reflow

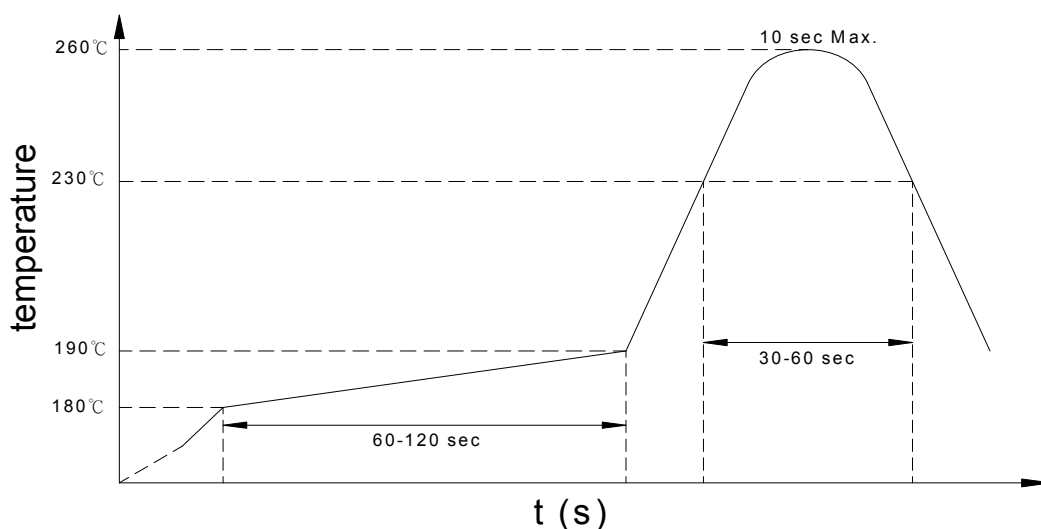

(b) Wave soldering :

- Temperature : 260°C or below (molten solder temperature)
- Time : 10 seconds or less
- Preheating conditions : 120°C or below (package surface temperature)
- Time(s) of reflow : One
- Flux : Rosin flux containing small amount of chlorine (The flux with a maximum chlorine content of 0.2 Wt% is recommended.)

(c) Cautions :

- Fluxes : Avoid removing the residual flux with freon-based and chlorine-based cleaning solvent.
- Avoid shorting between portion of frame and leads.

- **Numbering System**

KPC825 X Y (Z)

Notes:

KPC825 = Part No.

X = Lead form option (0,S,H,L)

Y = CTR rank (E)

Z = Tape and reel option (TL,TR,TLD,TRU)

Option	Description	Packing quantity
S (TL)	surface mount type package + TL tape & reel option	1000 units per reel
S (TR)	surface mount type package + TR tape & reel option	1000 units per reel
L (TLD)	long creepage distance for surface mount type package + TLD tape & reel option	1000 units per reel
L (TRU)	long creepage distance for surface mount type package + TRU tape & reel option	1000 units per reel

- **Recommended Pad Layout for Surface Mount Lead Form**

1.Surface mount type.

8 pin SMD

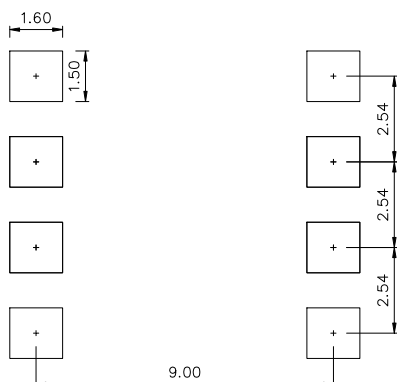
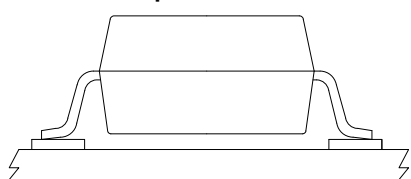

2.Long creepage distance for surface mount type.

8 pin L

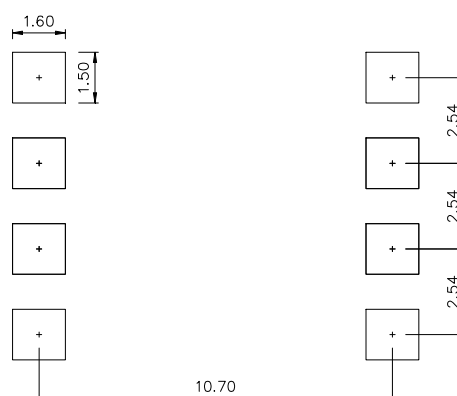
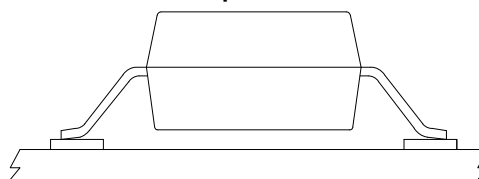

Unit : mm

<http://www.cosmo-ic.com>

● **8-pin SMD Carrier Tape & Reel**

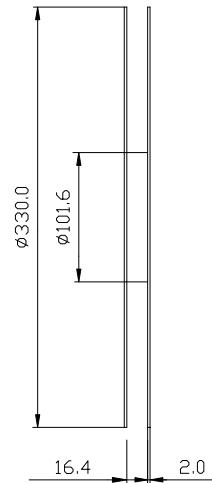
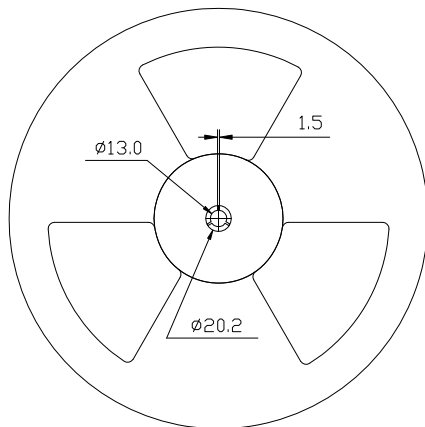
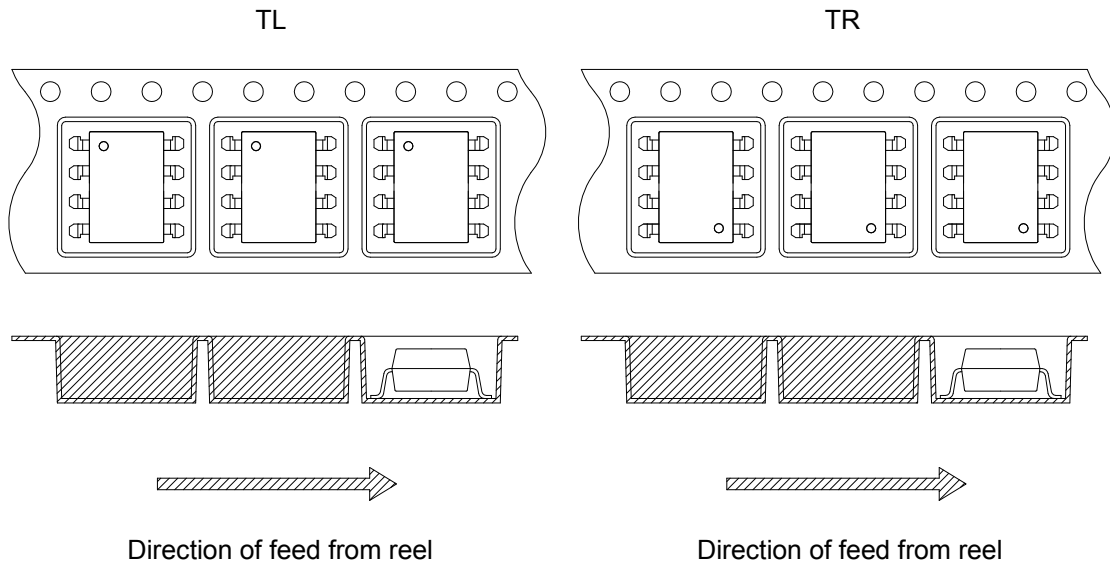
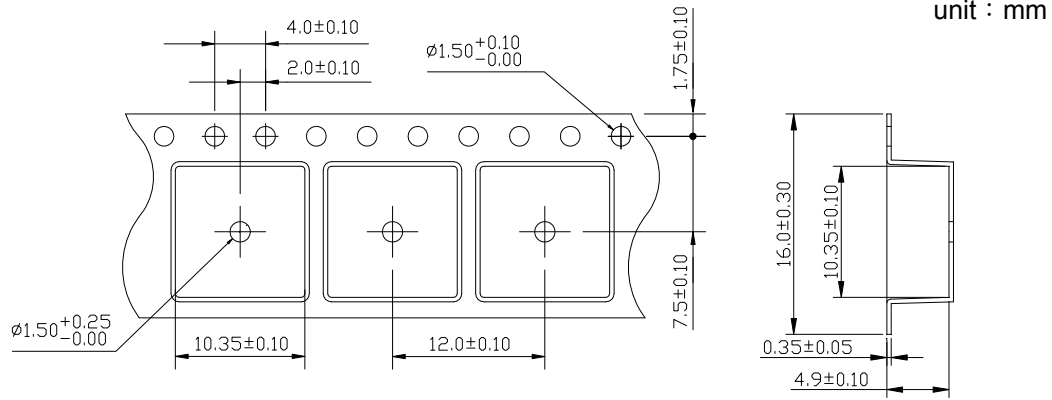

● 8-pin L Carrier Tape & Reel

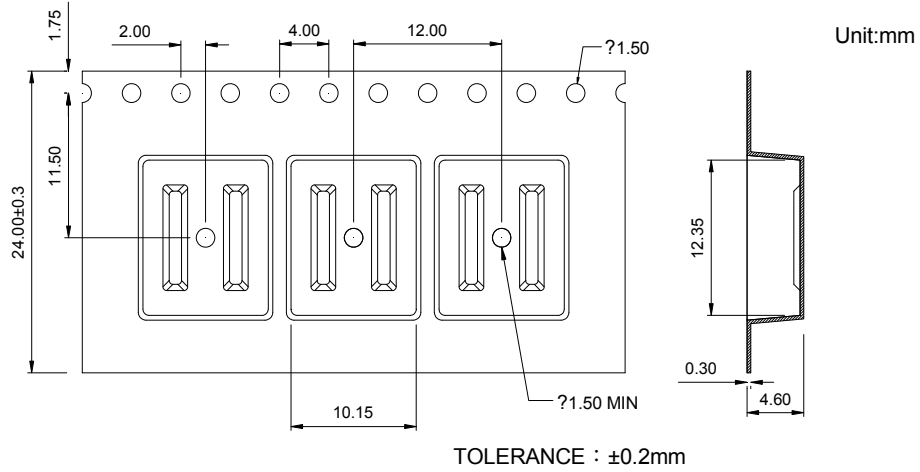

TLD

TRU

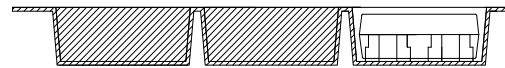
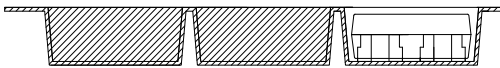
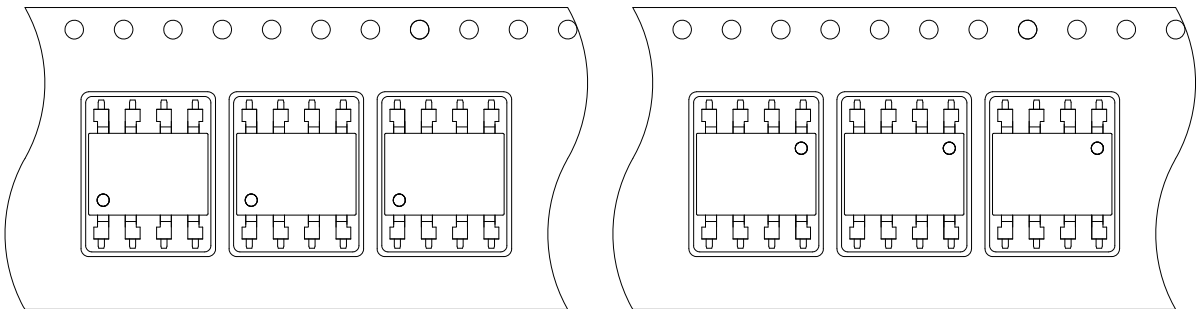

Direction of feed from reel

Direction of feed from reel

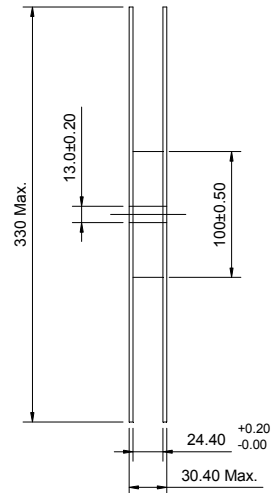
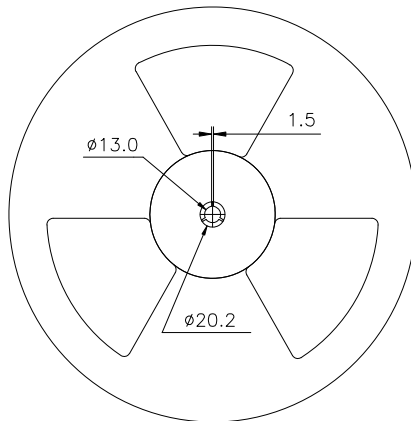

- **Application Notice**

The statements regarding the suitability of products for certain types of applications are based on cosmo's knowledge of general applications of cosmo products. Such statements are not binding statements about the suitability of products for a particular application. It is the customer's responsibility to verify the specifications are suitable for use in a particular application. Customers are solely responsible for all aspects of their own product design or applications. The parameters provided in the datasheet may vary in different applications and performance may vary over time. All operating parameters (including typical parameters) must be validated by customer's technical experts for different applications. cosmo assumes no liability for customer' product design or applications. Product specifications do not expand or otherwise change cosmo's terms and conditions of purchase, including but not limited to the warranty expressed therein.

When using cosmo products, please comply with safety standards and instructions. cosmo has no liability and responsibility to the damage caused by improper use of the instructions specified in the specifications.

cosmo products are designed for use in general electronic equipment such as telecommunications, office automation equipments, personal computers, test and measurement equipments, consumer electronics, industrial control, instrumentation, audio, video.

cosmo devices shall not be used in equipment that requires higher level of reliability and safety, such as nuclear power control equipment, telecommunication equipment(trunk lines), space application, medical and other life supporting equipments, and equipment for aircraft, military, automotive or any other application that can cause human injury or death.

cosmo reserves the right to change the specifications, data, characteristics, structure, materials and other contents at any time without notice. Please contact cosmo to obtain the latest specification.

cosmo disclaim any and all liability for any errors, inaccuracies or incompleteness contained in any datasheet or in any other disclosure relating to any product.