

## FLORENTINA-1-MRK-M

~40° medium beam. Compatible with ultra high power LEDs.

### SPECIFICATION:

|                |                |
|----------------|----------------|
| Dimensions     | 39.7 x 39.7 mm |
| Height         | 13 mm          |
| Fastening      | pin            |
| ROHS compliant | yes ⓘ          |

### MATERIALS:

| Component        | Type        | Material     | Colour | Finish |
|------------------|-------------|--------------|--------|--------|
| ROSE-MRK-M       | Single lens | PC           | clear  |        |
| FLORENTINA-1-HLD | Holder      | PC           | black  |        |
| ROSE-TAPE        | Tape        | Acrylic foam | black  |        |

### ORDERING INFORMATION:

| Component                      | Type        | Qty in box | MOQ | MPQ | Box weight (kg) |
|--------------------------------|-------------|------------|-----|-----|-----------------|
| FCA15512_FLORENTINA-1-MRK-M    | Single lens | 840        |     | 60  | 7.7             |
| » Box size: 480 x 280 x 300 mm |             |            |     |     |                 |

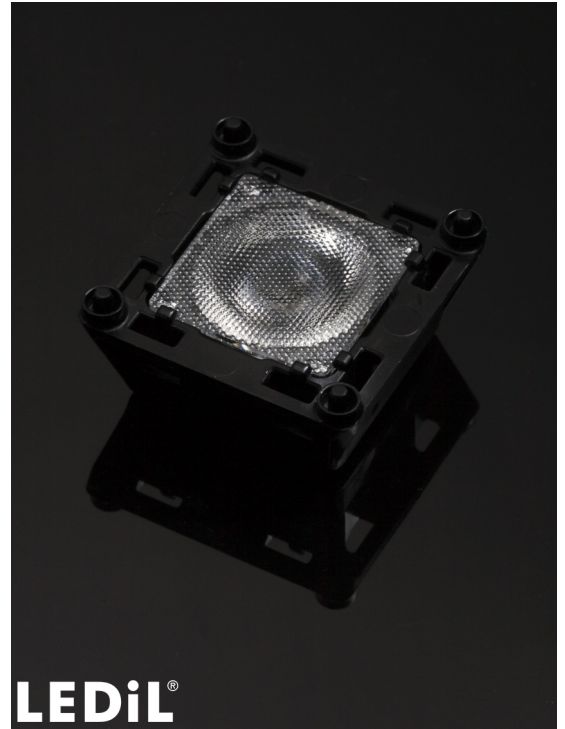

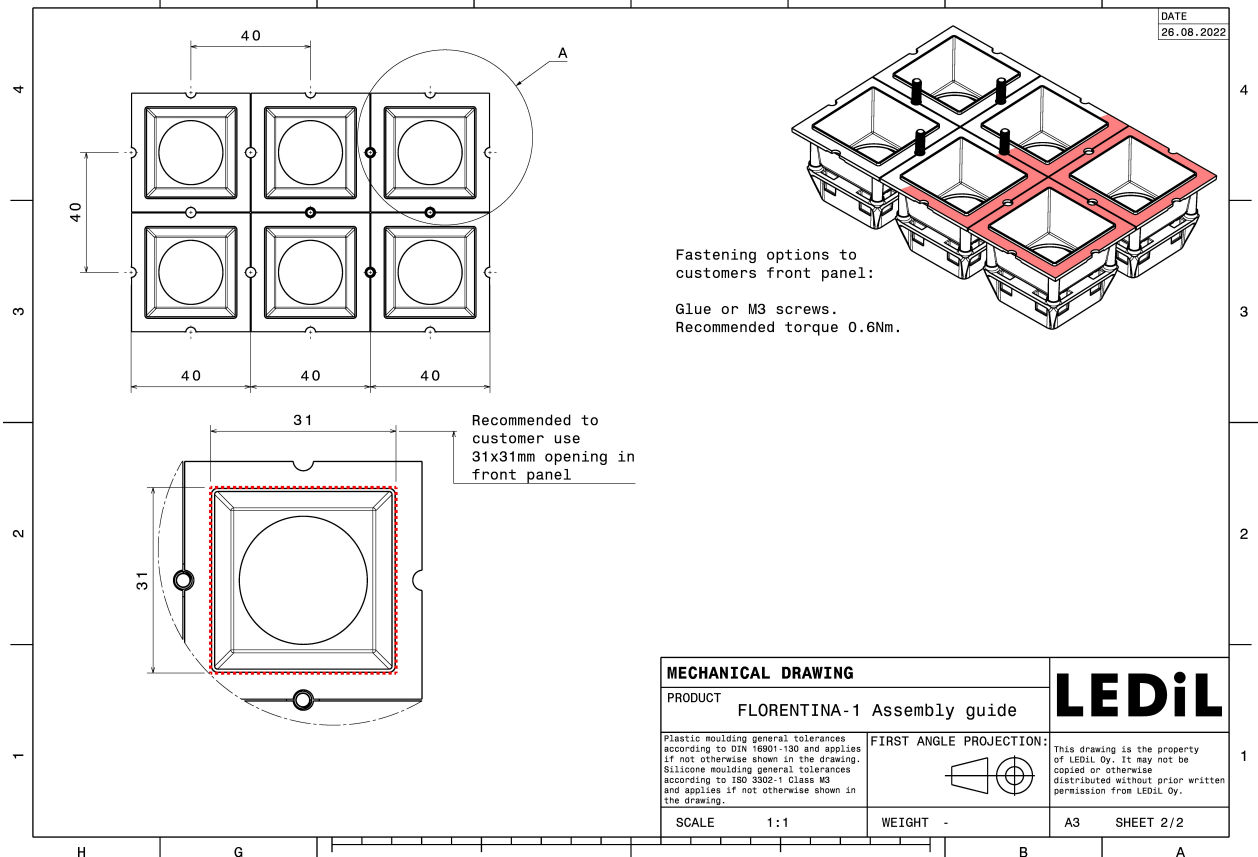
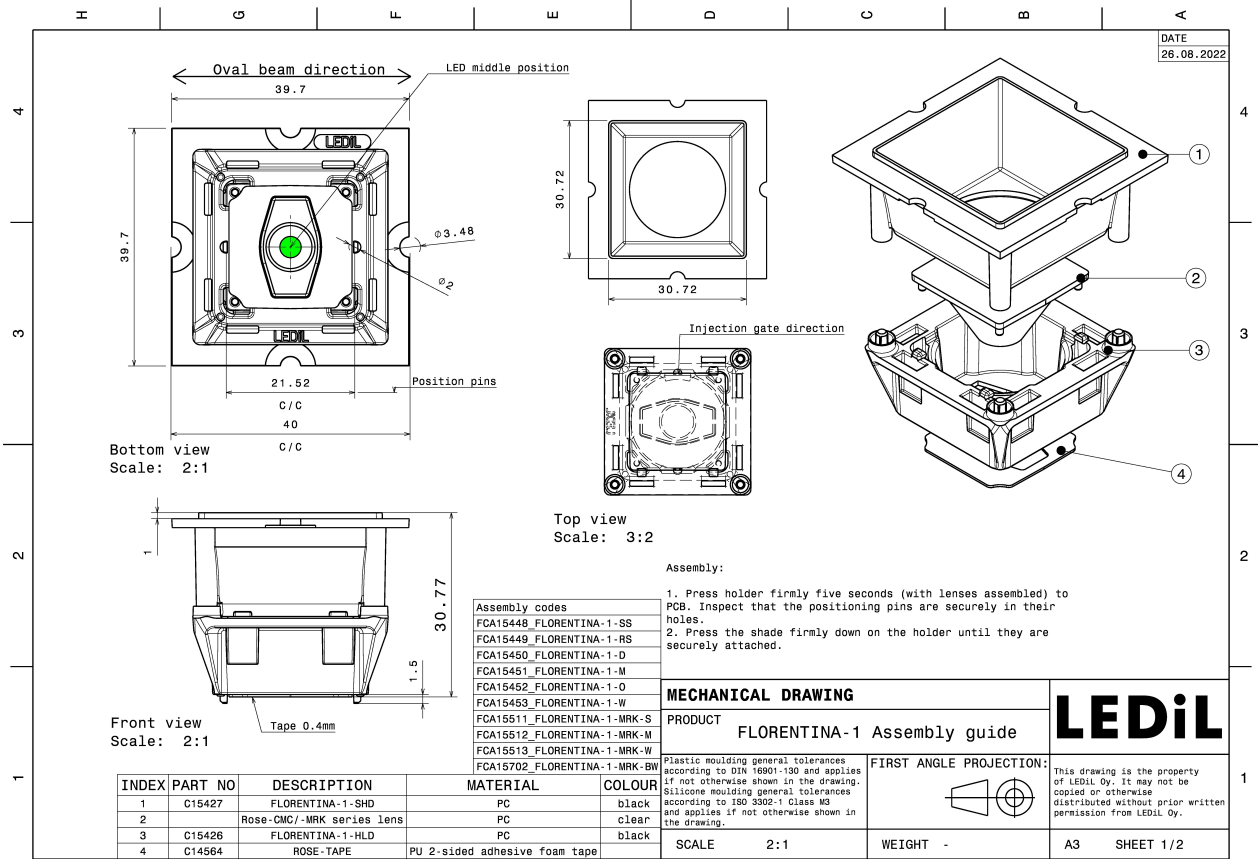

See also our general installation guide: [www.ledil.com/installation\\_guide](http://www.ledil.com/installation_guide)

#### OPTICAL RESULTS (MEASURED):



LED XHP35 HI  
 FWHM / FWTM 33.0° / 57.0°  
 Efficiency 77 %  
 Peak intensity 2.3 cd/m  
 LEDs/each optic 1  
 Light colour White  
 Required components:  
 C15427\_FLORENTINA-1-SHD-60

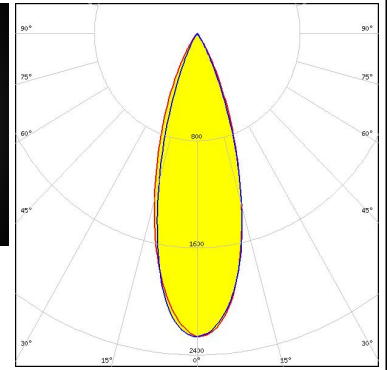
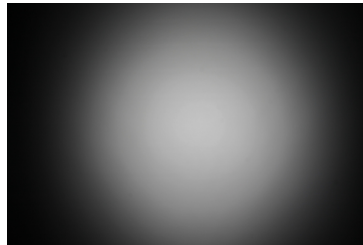

LED LUXEON 3030 2D (Round LES)  
 FWHM / FWTM 29.0° / 53.0°  
 Efficiency 79 %  
 Peak intensity 2.8 cd/m  
 LEDs/each optic 1  
 Light colour White  
 Required components:

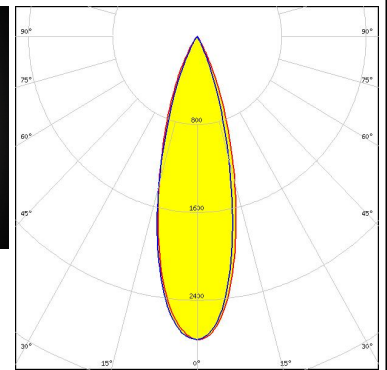
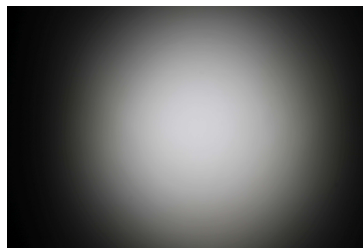

LED LUXEON 5050 Round LES  
 FWHM / FWTM 37.0° / 61.0°  
 Efficiency 78 %  
 Peak intensity 1.9 cd/m  
 LEDs/each optic 1  
 Light colour White  
 Required components:  
 C15427\_FLORENTINA-1-SHD-60

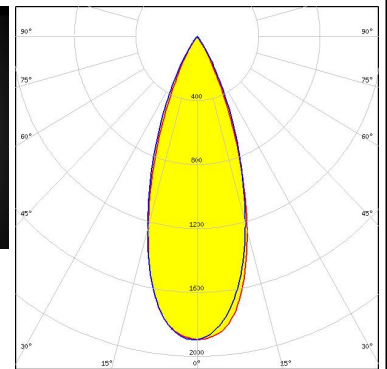

LED LUXEON M/MX  
 FWHM / FWTM 42.0° / 65.0°  
 Efficiency 75 %  
 Peak intensity 1.4 cd/m  
 LEDs/each optic 1  
 Light colour White  
 Required components:  
 C15427\_FLORENTINA-1-SHD-60

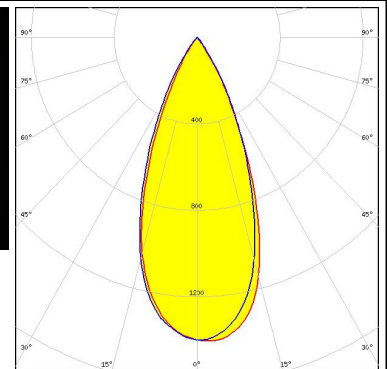
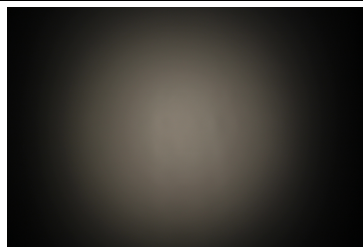

#### OPTICAL RESULTS (MEASURED):



LED NF2x757G  
 FWHM / FWTM 30.0° / 54.0°  
 Efficiency 81 %  
 Peak intensity 2.7 cd/lm  
 LEDs/each optic 1  
 Light colour White  
 Required components:  
 C15427\_FLORENTINA-1-SHD-60

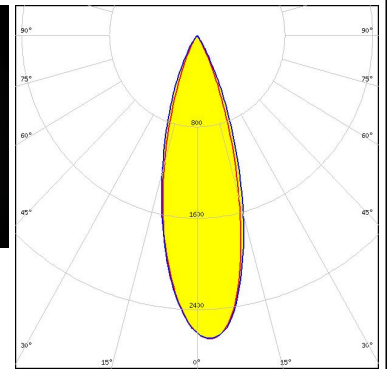
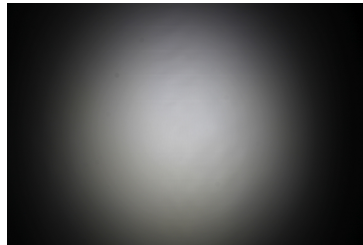

LED NF2x757G  
 FWHM / FWTM 31.0° / 54.0°  
 Efficiency 80 %  
 Peak intensity 2.6 cd/lm  
 LEDs/each optic 1  
 Light colour White  
 Required components:  
 C16701\_FLORENTINA-1-SHD-60-WHT

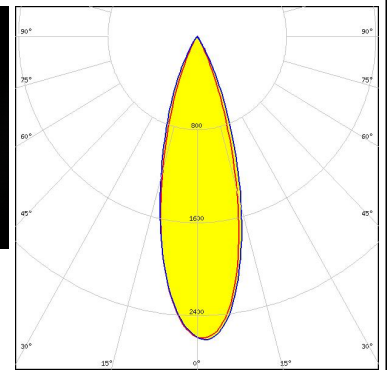
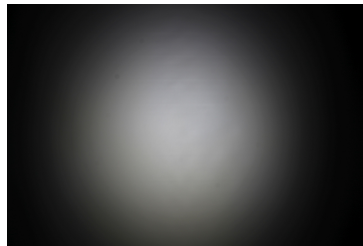



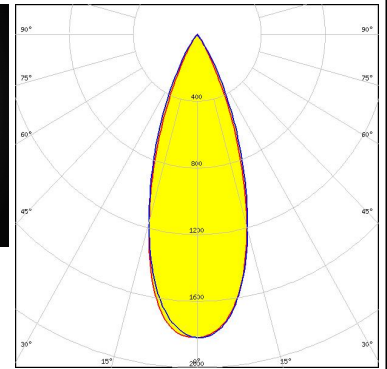
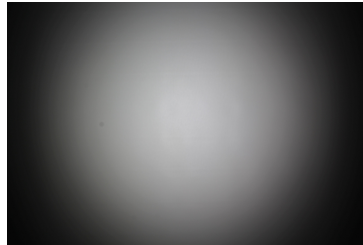

LED NFMW48xA  
 FWHM / FWTM 37.0° / 61.0°  
 Efficiency 75 %  
 Peak intensity 1.8 cd/lm  
 LEDs/each optic 1  
 Light colour White  
 Required components:  
 C15427\_FLORENTINA-1-SHD-60

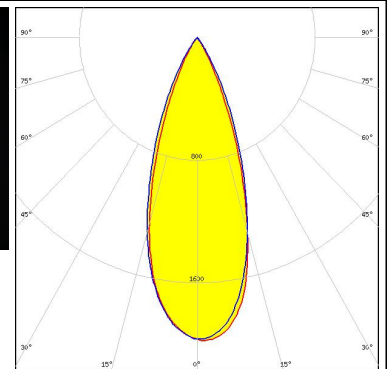
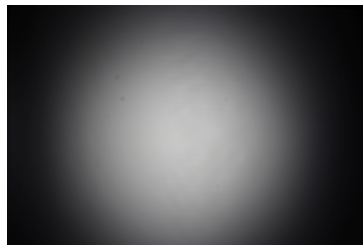

LED NVSW319B  
 FWHM / FWTM 21.0° / 40.0°  
 Efficiency 75 %  
 Peak intensity 4.5 cd/lm  
 LEDs/each optic 1  
 Light colour White  
 Required components:  
 C15427\_FLORENTINA-1-SHD-60

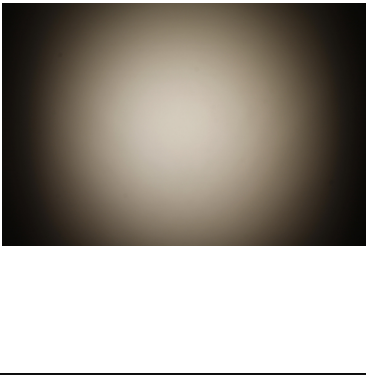
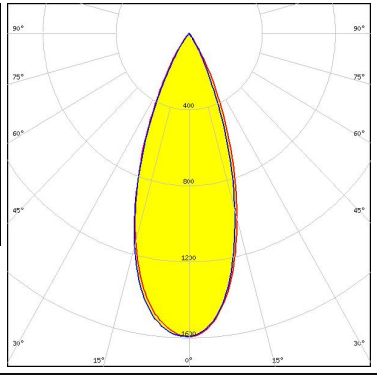

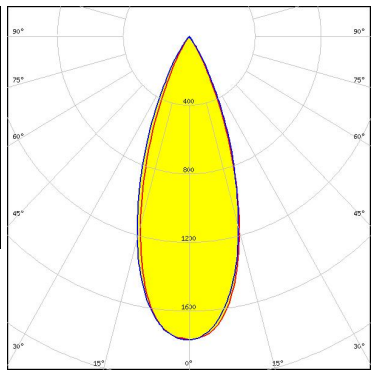
#### OPTICAL RESULTS (MEASURED):

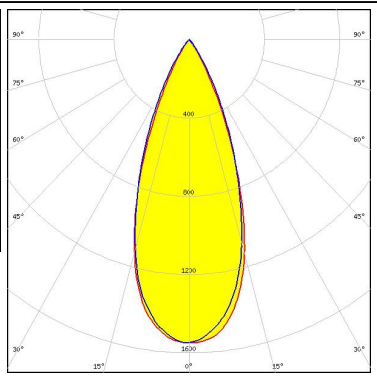
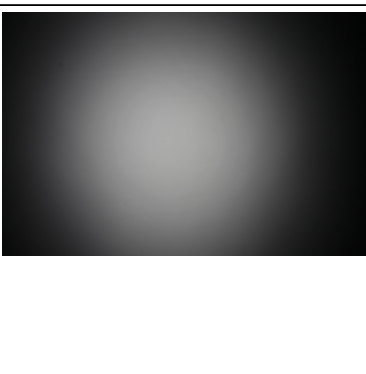
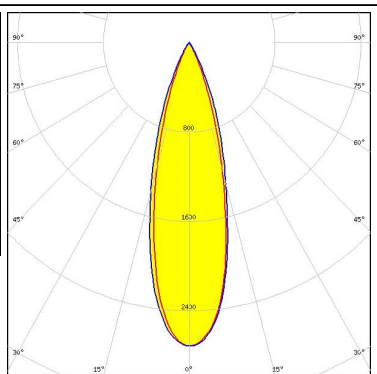
|  |  |   |
|--|--|---|
| <p><b>OSRAM</b><br/>Opto Semiconductors</p> <p>LED Duris S10</p> <p>FWHM / FWTM 38.0° / 62.0°</p> <p>Efficiency 70 %</p> <p>Peak intensity 1.6 cd/m</p> <p>LEDs/each optic 1</p> <p>Light colour White</p> <p>Required components:<br/>C15427_FLORENTINA-1-SHD-60</p>      |    |    |
| <p><b>OSRAM</b><br/>Opto Semiconductors</p> <p>LED Duris S8</p> <p>FWHM / FWTM 38.0° / 61.0°</p> <p>Efficiency 75 %</p> <p>Peak intensity 1.8 cd/m</p> <p>LEDs/each optic 1</p> <p>Light colour White</p> <p>Required components:<br/>C15427_FLORENTINA-1-SHD-60</p>       |   |   |
| <p><b>OSRAM</b><br/>Opto Semiconductors</p> <p>LED OSCONIQ P 7070</p> <p>FWHM / FWTM 40.0° / 62.0°</p> <p>Efficiency 74 %</p> <p>Peak intensity 1.6 cd/m</p> <p>LEDs/each optic 1</p> <p>Light colour White</p> <p>Required components:<br/>C15427_FLORENTINA-1-SHD-60</p> |  |  |
| <p><b>OSRAM</b><br/>Opto Semiconductors</p> <p>LED OSLON SSL 150</p> <p>FWHM / FWTM 27.0° / 49.0°</p> <p>Efficiency 76 %</p> <p>Peak intensity 2.7 cd/m</p> <p>LEDs/each optic 1</p> <p>Light colour White</p> <p>Required components:<br/>C15427_FLORENTINA-1-SHD-60</p>  |  |  |

#### OPTICAL RESULTS (MEASURED):

#### SAMSUNG

LED LM561B  
 FWHM / FWTM 31.0° / 55.0°  
 Efficiency 80 %  
 Peak intensity 2.6 cd/m  
 LEDs/each optic 1  
 Light colour White  
 Required components:  
 C15427\_FLORENTINA-1-SHD-60

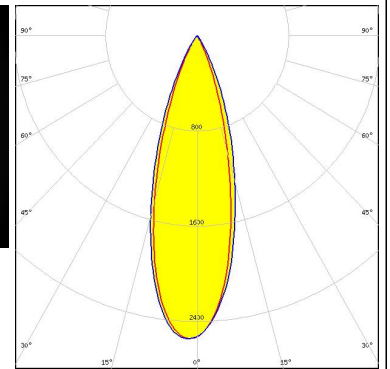
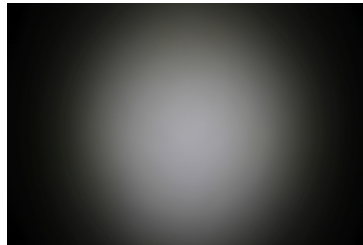

SEOUL SEMICONDUCTOR

LED SEOUL 5630  
 FWHM / FWTM 30.0° / 54.0°  
 Efficiency 83 %  
 Peak intensity 2.8 cd/m  
 LEDs/each optic 1  
 Light colour White  
 Required components:  
 C15427\_FLORENTINA-1-SHD-60

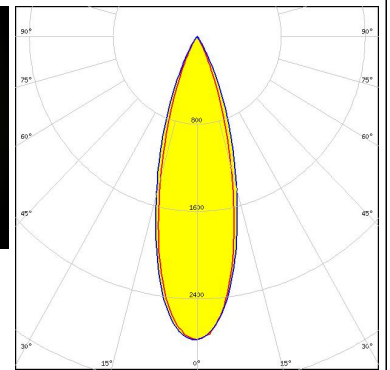
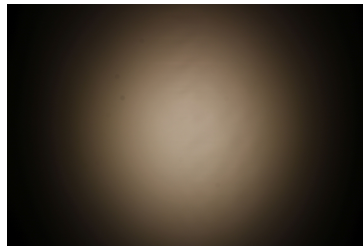

#### OPTICAL RESULTS (SIMULATED):

### SAMSUNG

|                      |                            |
|----------------------|----------------------------|
| LED                  | LH351B                     |
| FWHM / FWTM          | 35.0° / 68.0°              |
| Efficiency           | 77 %                       |
| Peak intensity       | 1.8 cd/lm                  |
| LEDs/each optic      | 1                          |
| Light colour         | White                      |
| Required components: |                            |
|                      | C15427_FLORENTINA-1-SHD-60 |

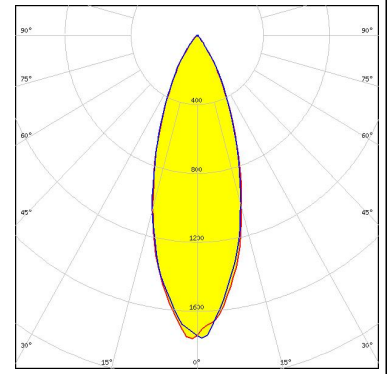

#### GENERAL INFORMATION:

NOTE: The typical beam angle will be changed by different color, chip size and chip position tolerance. The typical total beam angle is the full angle measured where the luminous intensity is half of the peak value.

#### MATERIALS:

As part of our continuous research and improvement processes, and to ensure the best possible quality and availability of our products, LEDiL reserves the right to change material grades without notice.

#### PRODUCT DATA USER AGREEMENT AND DISCLAIMER:

The measured data in the provided downloadable LEDiL Product Datasheets and Mechanical 2D-Drawings is rounded and provided as reference for planning. LEDiL Oy's optical specifications have been verified by conducting performance testing of the products in accordance with the company's quality system. The reported data are averaged results of multiple measurements with typical variation. LEDiL Oy reserves the right to without prior notification make changes and improvements to its products.

LEDiL Oy assumes neither warranty, nor guarantee nor any other liability of any kind for the contents and correctness of the provided data. The provided data has been generated with highest diligence but the provided data may in reality not represent the complete possible variation range of all intrinsic parameters. Therefore, in certain cases a deviation from the provided data could occur.

LEDiL Oy reserves the right to undertake technical changes of its products without further notification which could lead to changes in the provided data. LEDiL Oy assumes no liability of any kind for the possible deviation from any provided data or any other damage resulting from the usage of the provided data.

The user agrees to this disclaimer and user agreement with the download or usage of the provided files.

#### LEDiL Oy

Joensuunkatu 13  
FI-24240 SALO  
Finland

#### LEDiL Inc.

228 West Page Street  
Suite D  
Sycamore IL 60178  
USA

#### Ledil Optics Technology (Shenzhen) Co., Ltd.

# 405 , Block B  
Casic Motor Building  
Shenzhen 518057  
P.R.CHINA

#### Local sales and technical support

[www.ledil.com/  
where\\_to\\_buy](http://www.ledil.com/where_to_buy)

#### Shipping locations

Salo, Finland  
Hong Kong, China

#### Distribution Partners

[www.ledil.com/  
where\\_to\\_buy](http://www.ledil.com/where_to_buy)