

<b>PART NUMBER</b>		SML-LXIL2324SIC-TR	<b>REV</b>	C
<b>REV</b>	<b>E.C.N. NUMBER AND REVISION COMMENTS</b>		<b>DATE</b>	
A	E.C.N. #10BRDR. & REDRAWN.		10.03.13	
A	E.C.N. #11880.		10.03.13	
A	ECN-Lumex201700082		09.27.17	

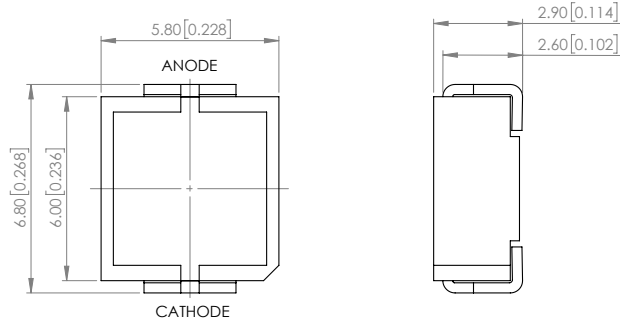

**POLARITY**

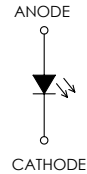

**ELECTRO-OPTICAL CHARACTERISTIC TA=25°C**

PARAMETER	MIN	TYP	MAX	UNITS	TEST COND
PEAK WAVELENGTH	-	625	-	nm	If=20mA
FORWARD VOLTAGE	-	2.0	2.4	Vf	If=20mA
REVERSE CURRENT	-	-	10	uA	VR=5V
LUMINOUS INTENSITY	-	45000	-	mcd	If=20mA
VIEWING ANGLE	-	12	-	2x theta1/2	-
EMITTED COLOR	RED				
EPOXY LENS FINISH	WATER CLEAR				

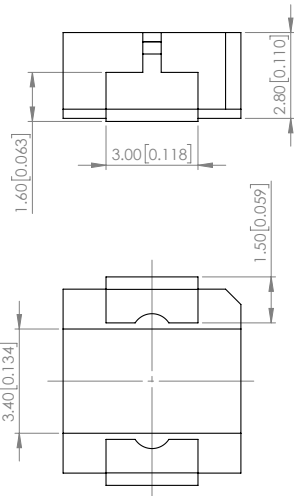

**RECOMMENDED SOLDER PAD LAYOUT**

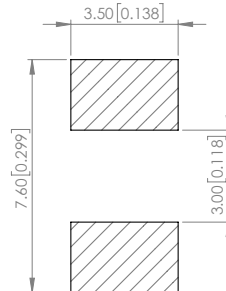

**ABSOLUTE MAXIMUM RATINGS TA=25°C**

PARAMETER	MAX	UNITS
FORWARD CURRENT	60	mA
REVERSE VOLTAGE	5	V
POWER DISSIPATION	144	mW
STORAGE TEMPERATURE	-30 TO +85	°C
OPERATING TEMPERATURE	-30 TO +85	°C

MOISTURE SENSITIVE DEVICE  
PER JEDEC LEVEL 4 STANDARDS

\*UNLESS OTHERWISE SPECIFIED TOLERANCES PER DECIMAL PRECISION ARE: X=±1 (±0.039), X.X=±0.5 (±0.020), X.XX=±0.25 (±0.010), X.XXX=±0.127 (±0.005). LEAD SIZE=±0.05 (±0.002), LEAD LENGTH=±0.75 (±0.030), MIN=<sup>DECIMAL PRECISION</sup>/<sub>0.00</sub> MAX.=<sup>DECIMAL PRECISION</sup>/<sub>0.00</sub>



425 N. GARY AVE.  
CAROL STREAM, IL 60188  
PHONE : 800-278-5666  
FAX : 630-315-2150  
WEB : WWW.LUMEX.COM

6.8(L)\*5.8(W)\*2.9(H)mm, NARROW BEAM 6mm SMT LED, 625nm RED LED, WATER CLEAR LENS, TAPE & REEL.

\*\*THE SPECIFICATIONS MAY CHANGE AT ANY TIME WITHOUT NOTICE DUE TO NEW MATERIALS OR PRODUCT IMPROVEMENT.\*\*

CONFIDENTIAL INFORMATION  
THE INFORMATION CONTAINED IN THIS DOCUMENT IS THE PROPERTY OF LUMEX INC. EXCEPT AS SPECIFICALLY AUTHORIZED IN WRITING BY LUMEX INC., THE HOLDER OF THIS DOCUMENT SHALL KEEP ALL INFORMATION CONTAINED HEREIN CONFIDENTIAL AND SHALL PROTECT SAME IN WHOLE OR IN PART FROM DISCLOSURE AND DISSEMINATION TO ALL THIRD PARTIES.

DATE : 2017.09.27	DRAWN BY : C.C.
PAGE : 1 OF 3	CHKD BY : G.Y.
SCALE : NTF	APRVD BY : E.C.
UNIT : mm [INCH]	Ⓢ

**PROFILE**

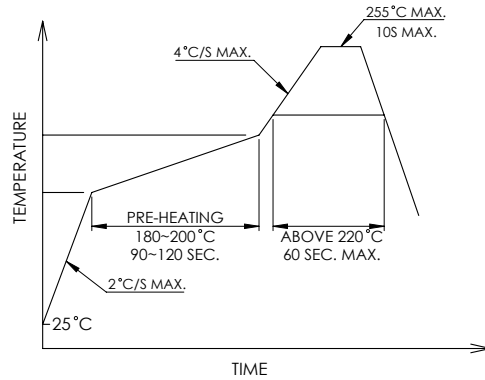

**CARRIER TAPE DIMENSION**

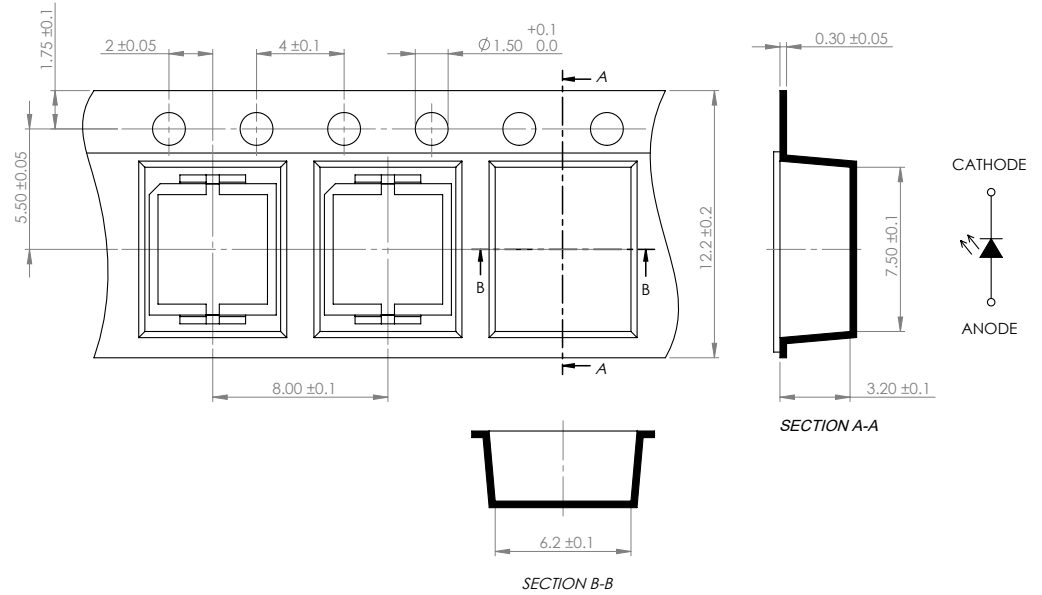

\*UNLESS OTHERWISE SPECIFIED TOLERANCES PER DECIMAL PRECISION ARE: X=±1 (±0.039), X.X=±0.5 (±0.020), X.XX=±0.25 (±0.010), X.XXX=±0.127 (±0.005). LEAD SIZE=±0.05 (±0.002), LEAD LENGTH=±0.75 (±0.030), MIN=<sup>DECIMAL PRECISION</sup><sub>0.00</sub> MAX.=<sup>DECIMAL PRECISION</sup><sub>0.00</sub>

**LUMEX**  
 Creating LED and LCD Solutions Together™  
 425 N. GARY AVE.  
 CAROL STREAM, IL 60188  
 PHONE : 800-278-5666  
 FAX : 630-315-2150  
 WEB : WWW.LUMEX.COM

6.8(L)\*5.8(W)\*2.9(H)mm, NARROW BEAM 6mm SMT LED, 625nm RED LED, WATER CLEAR LENS, TAPE & REEL.  
**\*\*THE SPECIFICATIONS MAY CHANGE AT ANY TIME WITHOUT NOTICE DUE TO NEW MATERIALS OR PRODUCT IMPROVEMENT.\*\***  
**CONFIDENTIAL INFORMATION**  
 THE INFORMATION CONTAINED IN THIS DOCUMENT IS THE PROPERTY OF LUMEX INC. EXCEPT AS SPECIFICALLY AUTHORIZED IN WRITING BY LUMEX INC., THE HOLDER OF THIS DOCUMENT SHALL KEEP ALL INFORMATION CONTAINED HEREIN CONFIDENTIAL AND SHALL PROTECT SAME IN WHOLE OR IN PART FROM DISCLOSURE AND DISSEMINATION TO ALL THIRD PARTIES.

DATE : 2017.09.27	DRAWN BY : C.C.
PAGE : 2 OF 3	CHKD BY : G.Y.
SCALE : NTF	APRVD BY : E.C.
UNIT : mm [INCH]	Ⓢ

**DIRECTIVITY (TYPICAL)**

DIRECTIVITY

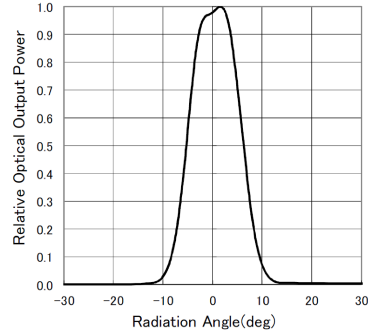

**CHARACTERISTICS (TYPICAL)**

AMBIENT TEMPERATURE vs. FORWARD CURRENT

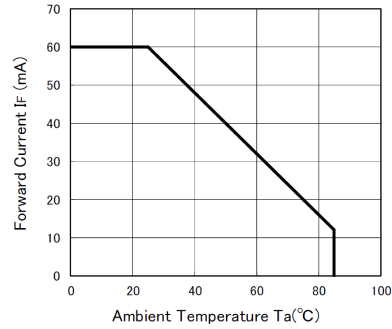

FORWARD CURRENT vs. RELATIVE OPTICAL OUTPUT POWER

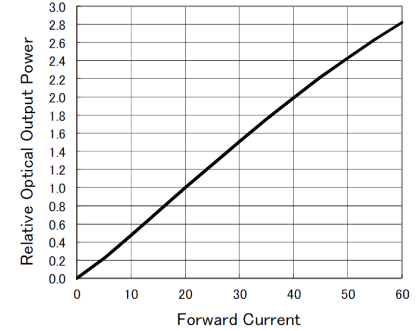

FORWARD VOLTAGE vs. FORWARD CURRENT  
CONDITION : Ta=25°C

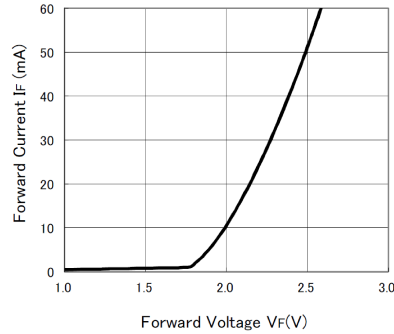

RELATIVE INTENSITY vs. WAVELENGTH  
CONDITION : Ta=25°C, IF=20mA

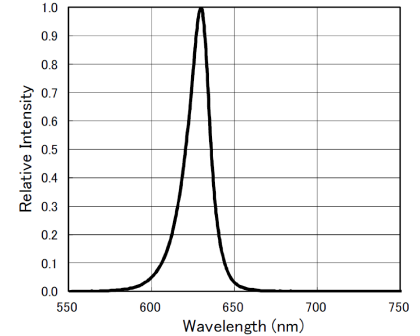

\*UNLESS OTHERWISE SPECIFIED TOLERANCES PER DECIMAL PRECISION ARE: X=±1 (±0.039), X.X=±0.5 (±0.020), X.XX=±0.25 (±0.010), X.XXX=±0.127 (±0.005). LEAD SIZE=±0.05 (±0.002), LEAD LENGTH=±0.75 (±0.030), MIN= <sup>±0.00</sup> DECIMAL PRECISION, MAX= <sup>±0.00</sup> DECIMAL PRECISION



425 N. GARY AVE.  
CAROL STREAM, IL 60188  
PHONE : 800-278-5666  
FAX : 630-315-2150  
WEB : WWW.LUMEX.COM

6.8(L)\*5.8(W)\*2.9(H)mm, NARROW BEAM 6mm SMT LED, 625nm RED LED, WATER CLEAR LENS, TAPE & REEL.

\*\*THE SPECIFICATIONS MAY CHANGE AT ANY TIME WITHOUT NOTICE DUE TO NEW MATERIALS OR PRODUCT IMPROVEMENT.\*\*

CONFIDENTIAL INFORMATION  
THE INFORMATION CONTAINED IN THIS DOCUMENT IS THE PROPERTY OF LUMEX INC. EXCEPT AS SPECIFICALLY AUTHORIZED IN WRITING BY LUMEX INC., THE HOLDER OF THIS DOCUMENT SHALL KEEP ALL INFORMATION CONTAINED HEREIN CONFIDENTIAL AND SHALL PROTECT SAME IN WHOLE OR IN PART FROM DISCLOSURE AND DISSEMINATION TO ALL THIRD PARTIES.

DATE : 2017.09.27	DRAWN BY : C.C.
PAGE : 3 OF 3	CHKD BY : G.Y.
SCALE : NTF	APRVD BY : E.C.
UNIT : mm [INCH]	Ⓢ