

### General Description

The AON6520 uses advanced trench technology to provide excellent  $R_{DS(ON)}$ , low gate charge. This device is suitable for use as a high side switch in SMPS and general purpose applications.

### Product Summary

$V_{DS}$	30V
$I_D$ (at $V_{GS}=10V$ )	50A
$R_{DS(ON)}$ (at $V_{GS}=10V$ )	< 8.5m $\Omega$
$R_{DS(ON)}$ (at $V_{GS}=4.5V$ )	< 11m $\Omega$

100% UIS Tested  
 100%  $R_g$  Tested

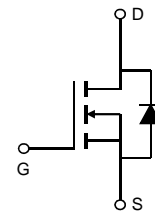
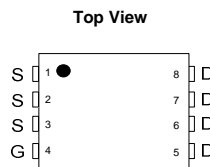
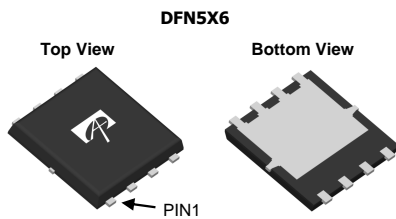

### Absolute Maximum Ratings $T_A=25^\circ\text{C}$ unless otherwise noted

Parameter	Symbol	Maximum	Units
Drain-Source Voltage	$V_{DS}$	30	V
Gate-Source Voltage	$V_{GS}$	$\pm 20$	V
Continuous Drain Current	$I_D$	$T_C=25^\circ\text{C}$	50
		$T_C=100^\circ\text{C}$	29
Pulsed Drain Current <sup>C</sup>	$I_{DM}$	140	A
Continuous Drain Current	$I_{DSM}$	$T_A=25^\circ\text{C}$	11
		$T_A=70^\circ\text{C}$	9
Avalanche Current <sup>C</sup>	$I_{AS}, I_{AR}$	35	A
Avalanche energy $L=0.05\text{mH}$ <sup>C</sup>	$E_{AS}, E_{AR}$	31	mJ
Power Dissipation <sup>B</sup>	$P_D$	$T_C=25^\circ\text{C}$	31
		$T_C=100^\circ\text{C}$	12.5
Power Dissipation <sup>A</sup>	$P_{DSM}$	$T_A=25^\circ\text{C}$	1.9
		$T_A=70^\circ\text{C}$	1.2
Junction and Storage Temperature Range	$T_J, T_{STG}$	-55 to 150	$^\circ\text{C}$

### Thermal Characteristics

Parameter	Symbol	Typ	Max	Units
Maximum Junction-to-Ambient <sup>A</sup>	$R_{\theta JA}$	24	30	$^\circ\text{C/W}$
Maximum Junction-to-Ambient <sup>A,D</sup>				
Maximum Junction-to-Case	$R_{\theta JC}$	3.4	4	$^\circ\text{C/W}$

Electrical Characteristics ( $T_J=25^\circ\text{C}$  unless otherwise noted)

Symbol	Parameter	Conditions	Min	Typ	Max	Units
<b>STATIC PARAMETERS</b>						
$BV_{DSS}$	Drain-Source Breakdown Voltage	$I_D=250\mu\text{A}$ , $V_{GS}=0\text{V}$	30			V
$I_{DSS}$	Zero Gate Voltage Drain Current	$V_{DS}=30\text{V}$ , $V_{GS}=0\text{V}$ $T_J=55^\circ\text{C}$			1 5	$\mu\text{A}$
$I_{GSS}$	Gate-Body leakage current	$V_{DS}=0\text{V}$ , $V_{GS}=\pm 20\text{V}$			100	nA
$V_{GS(th)}$	Gate Threshold Voltage	$V_{DS}=V_{GS}$ , $I_D=250\mu\text{A}$	1.5	1.95	2.5	V
$I_{D(ON)}$	On state drain current	$V_{GS}=10\text{V}$ , $V_{DS}=5\text{V}$	140			A
$R_{DS(ON)}$	Static Drain-Source On-Resistance	$V_{GS}=10\text{V}$ , $I_D=20\text{A}$ $T_J=125^\circ\text{C}$		7 10	8.5 12	m $\Omega$
		$V_{GS}=4.5\text{V}$ , $I_D=20\text{A}$		8.5	11	
$g_{FS}$	Forward Transconductance	$V_{DS}=5\text{V}$ , $I_D=20\text{A}$		55		S
$V_{SD}$	Diode Forward Voltage	$I_S=1\text{A}$ , $V_{GS}=0\text{V}$		0.72	1	V
$I_S$	Maximum Body-Diode Continuous Current				35	A
<b>DYNAMIC PARAMETERS</b>						
$C_{iss}$	Input Capacitance	$V_{GS}=0\text{V}$ , $V_{DS}=15\text{V}$ , $f=1\text{MHz}$	920	1150	1380	pF
$C_{oss}$	Output Capacitance		125	180	235	pF
$C_{riss}$	Reverse Transfer Capacitance		60	105	150	pF
$R_g$	Gate resistance	$V_{GS}=0\text{V}$ , $V_{DS}=0\text{V}$ , $f=1\text{MHz}$	0.55	1.1	1.65	$\Omega$
<b>SWITCHING PARAMETERS</b>						
$Q_g(10\text{V})$	Total Gate Charge	$V_{GS}=10\text{V}$ , $V_{DS}=15\text{V}$ , $I_D=20\text{A}$	16	20	24	nC
$Q_g(4.5\text{V})$	Total Gate Charge		7.6	9.5	11.4	nC
$Q_{gs}$	Gate Source Charge		2	2.7	3.2	nC
$Q_{gd}$	Gate Drain Charge		3	5	7	nC
$t_{D(on)}$	Turn-On DelayTime	$V_{GS}=10\text{V}$ , $V_{DS}=15\text{V}$ , $R_L=0.75\Omega$ , $R_{GEN}=3\Omega$		6.5		ns
$t_r$	Turn-On Rise Time			2		ns
$t_{D(off)}$	Turn-Off DelayTime			17		ns
$t_f$	Turn-Off Fall Time			3.5		ns
$t_{rr}$	Body Diode Reverse Recovery Time	$I_F=20\text{A}$ , $dI/dt=500\text{A}/\mu\text{s}$	7	8.7	10.5	ns
$Q_{rr}$	Body Diode Reverse Recovery Charge	$I_F=20\text{A}$ , $dI/dt=500\text{A}/\mu\text{s}$	11	13.5	16	nC

A. The value of  $R_{\theta JA}$  is measured with the device mounted on 1in<sup>2</sup> FR-4 board with 2oz. Copper, in a still air environment with  $T_A=25^\circ\text{C}$ . The Power dissipation  $P_{DSM}$  is based on  $R_{\theta JA}$  and the maximum allowed junction temperature of  $150^\circ\text{C}$ . The value in any given application depends on the user's specific board design.

B. The power dissipation  $P_D$  is based on  $T_{J(MAX)}=150^\circ\text{C}$ , using junction-to-case thermal resistance, and is more useful in setting the upper dissipation limit for cases where additional heatsinking is used.

C. Repetitive rating, pulse width limited by junction temperature  $T_{J(MAX)}=150^\circ\text{C}$ . Ratings are based on low frequency and duty cycles to keep initial  $T_J=25^\circ\text{C}$ .

D. The  $R_{\theta JA}$  is the sum of the thermal impedance from junction to case  $R_{\theta JC}$  and case to ambient.

E. The static characteristics in Figures 1 to 6 are obtained using  $<300\mu\text{s}$  pulses, duty cycle 0.5% max.

F. These curves are based on the junction-to-case thermal impedance which is measured with the device mounted to a large heatsink, assuming a maximum junction temperature of  $T_{J(MAX)}=150^\circ\text{C}$ . The SOA curve provides a single pulse rating.

G. The maximum current rating is limited by package.

H. These tests are performed with the device mounted on 1 in<sup>2</sup> FR-4 board with 2oz. Copper, in a still air environment with  $T_A=25^\circ\text{C}$ .

COMPONENTS IN LIFE SUPPORT DEVICES OR SYSTEMS ARE NOT AUTHORIZED. AOS DOES NOT ASSUME ANY LIABILITY ARISING OUT OF SUCH APPLICATIONS OR USES OF ITS PRODUCTS. AOS RESERVES THE RIGHT TO IMPROVE PRODUCT DESIGN, FUNCTIONS AND RELIABILITY WITHOUT NOTICE.

TYPICAL ELECTRICAL AND THERMAL CHARACTERISTICS

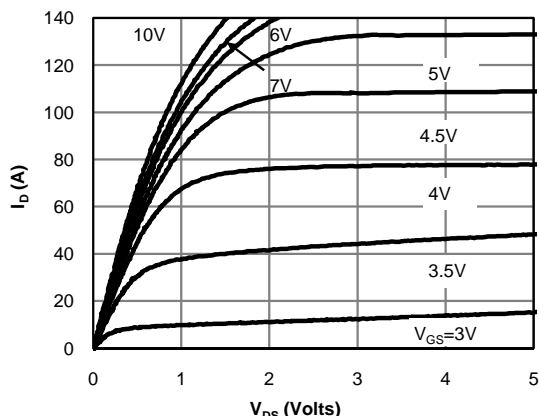

Fig 1: On-Region Characteristics (Note E)

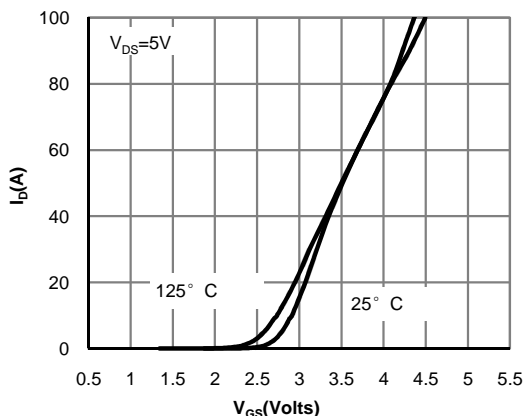

Figure 2: Transfer Characteristics (Note E)

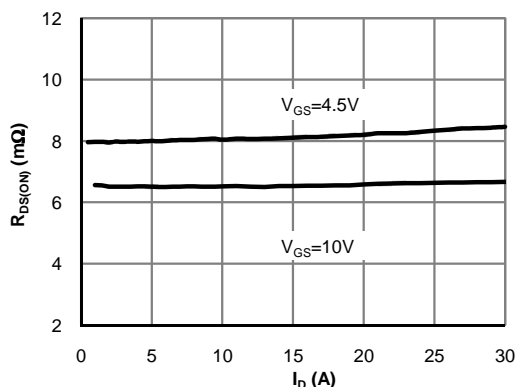

Figure 3: On-Resistance vs. Drain Current and Gate Voltage (Note E)

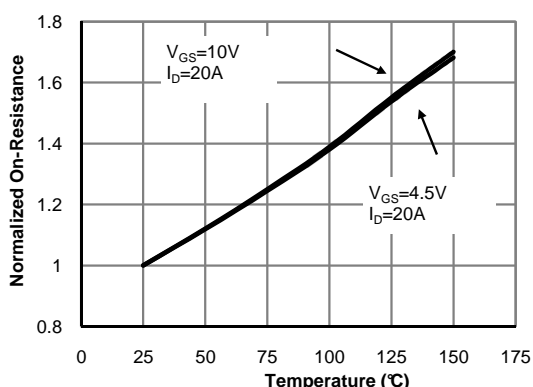

Figure 4: On-Resistance vs. Junction Temperature (Note E)

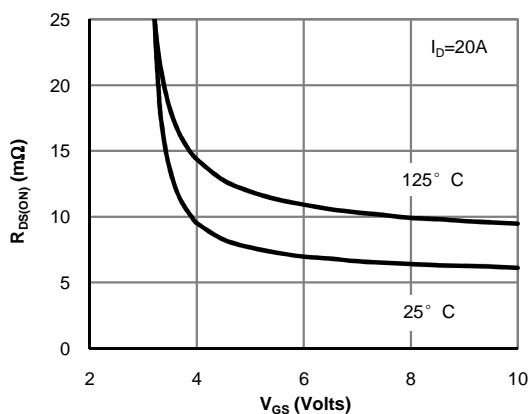

Figure 5: On-Resistance vs. Gate-Source Voltage (Note E)

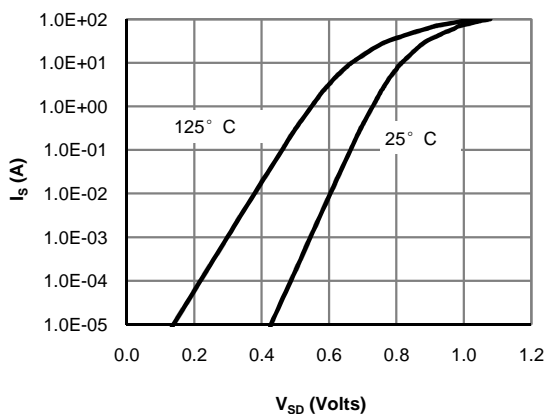

Figure 6: Body-Diode Characteristics (Note E)

TYPICAL ELECTRICAL AND THERMAL CHARACTERISTICS

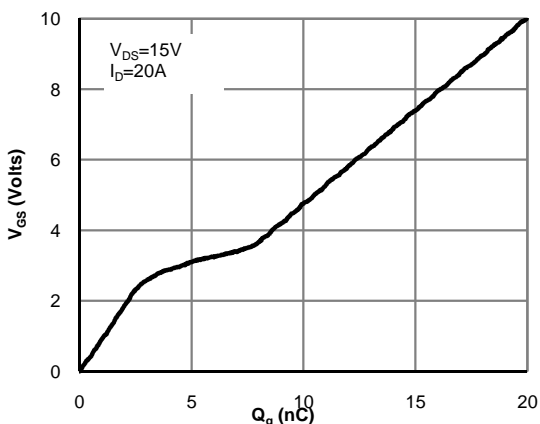

Figure 7: Gate-Charge Characteristics

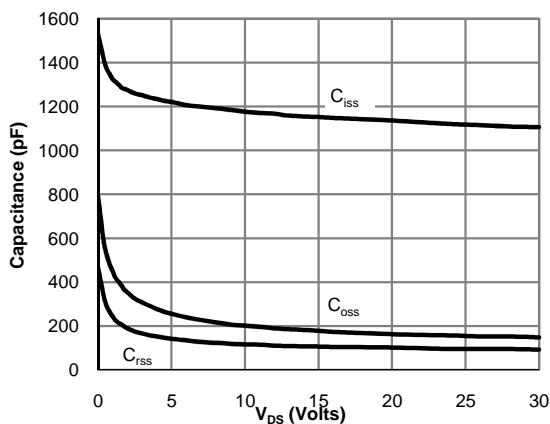

Figure 8: Capacitance Characteristics

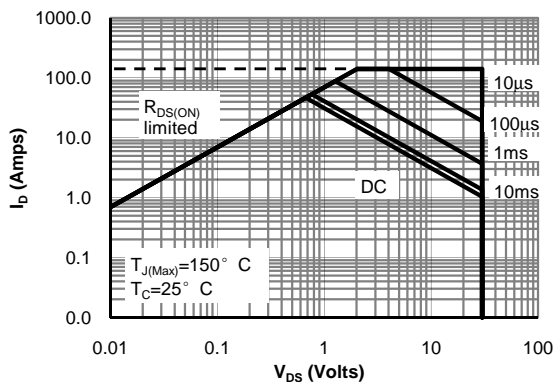

Figure 9: Maximum Forward Biased Safe Operating Area (Note F)

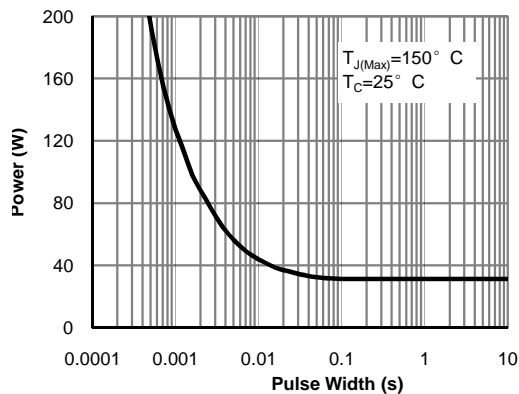

Figure 10: Single Pulse Power Rating Junction-to-Case (Note F)

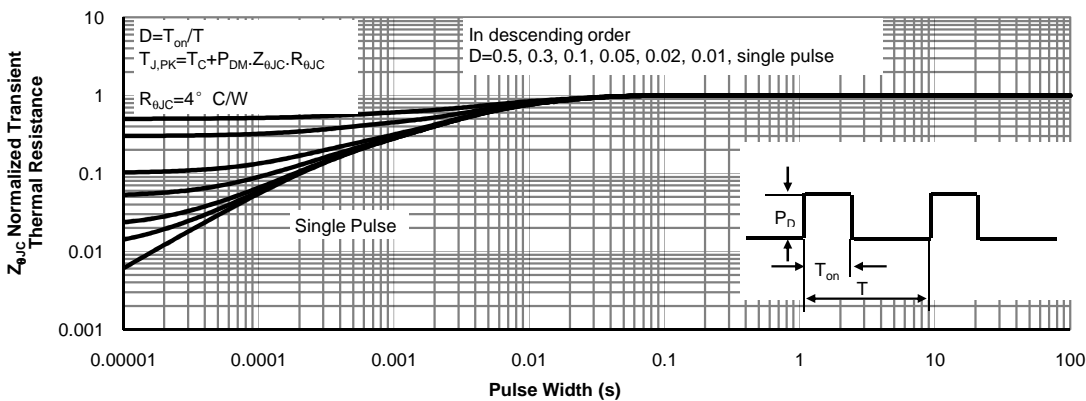

Figure 11: Normalized Maximum Transient Thermal Impedance (Note F)

TYPICAL ELECTRICAL AND THERMAL CHARACTERISTICS

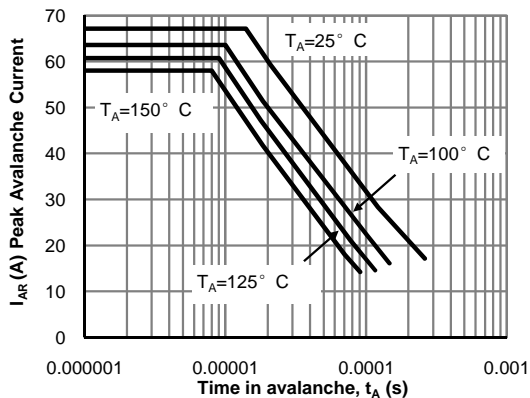

Figure 12: Single Pulse Avalanche capability (Note C)

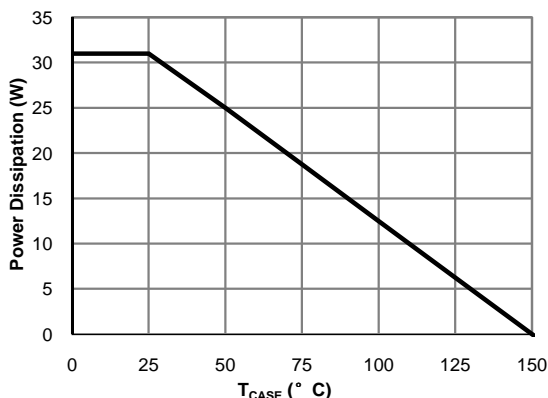

Figure 13: Power De-rating (Note F)

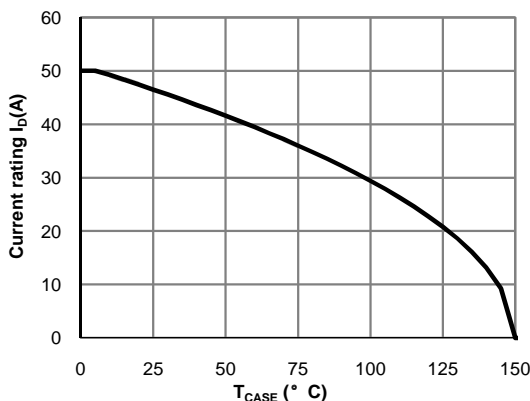

Figure 14: Current De-rating (Note F)

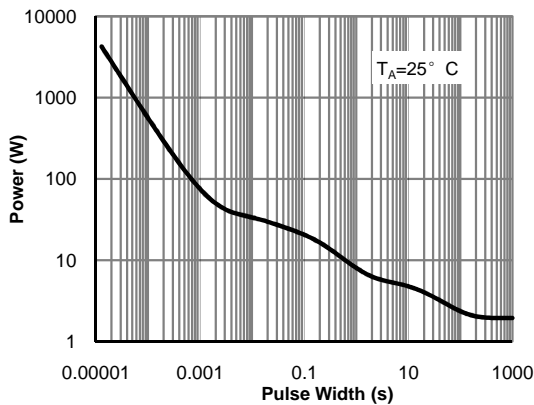

Figure 15: Single Pulse Power Rating Junction-to-Ambient (Note H)

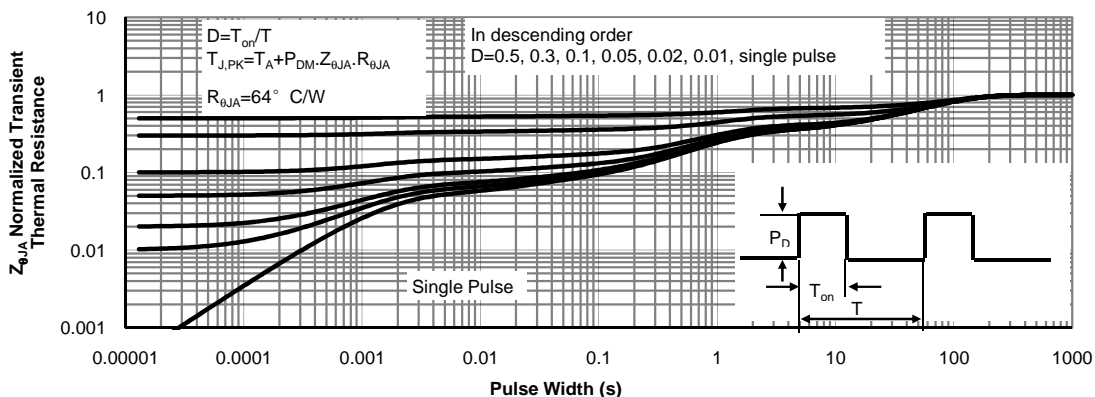
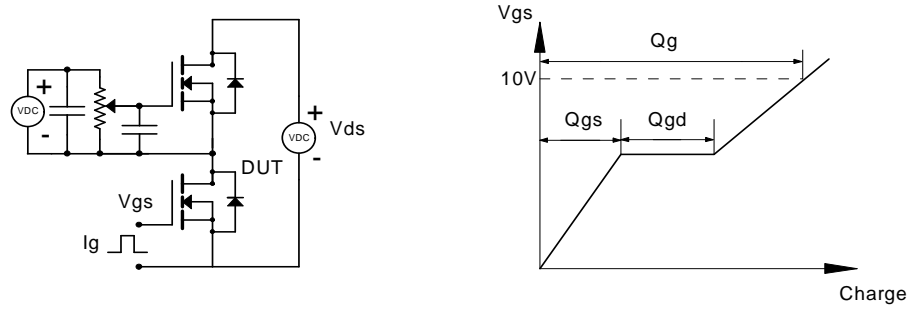
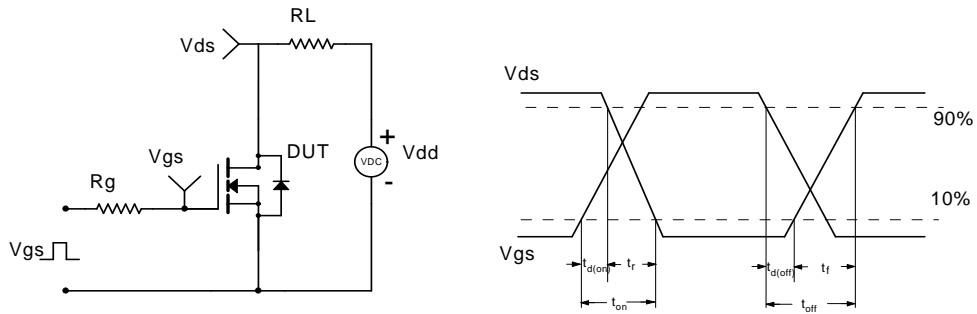

Figure 16: Normalized Maximum Transient Thermal Impedance (Note H)

Gate Charge Test Circuit & Waveform



Resistive Switching Test Circuit & Waveforms



Unclamped Inductive Switching (UIS) Test Circuit & Waveforms

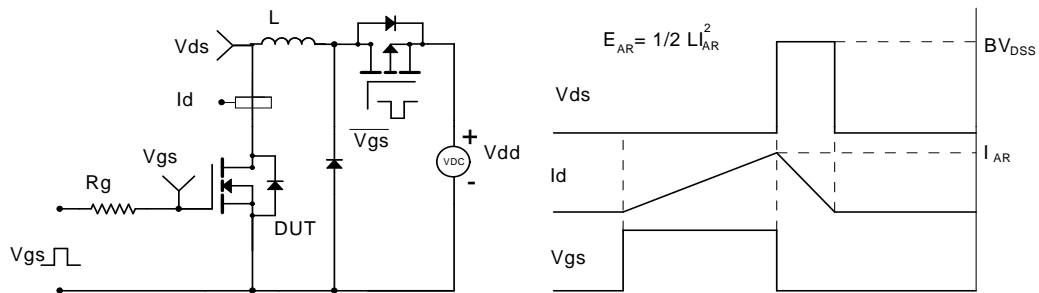

Diode Recovery Test Circuit & Waveforms

