

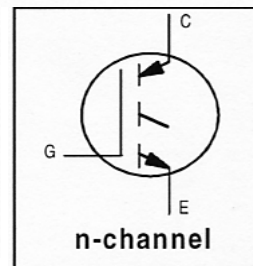
# IRG4RC10SPbF

## INSULATED GATE BIPOLAR TRANSISTOR

## Standard Speed IGBT

### Features

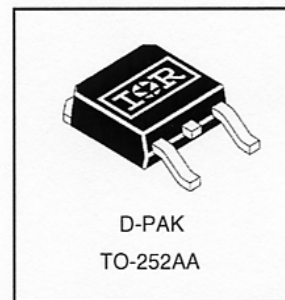
- Extremely low voltage drop; 1.0V typical at 2A, 100°C
- Standard: Optimized for minimum saturation voltage and low operating frequencies (< 1kHz)
- Generation 4 IGBT design provides tighter parameter distribution and higher efficiency than previous generation
- Industry standard TO-252AA package
- Lead-Free



$V_{CES} = 600V$
$V_{CE(on)} \text{ typ.} = 1.10V$
@ $V_{GE} = 15V, I_C = 2.0A$

### Benefits

- Generation 4 IGBT's offer highest efficiency available
- IGBT's optimized for specified application conditions



### Absolute Maximum Ratings

	Parameter	Max.	Units
$V_{CES}$	Collector-to-Emitter Breakdown Voltage	600	V
$I_C @ T_C = 25^\circ C$	Continuous Collector Current	14	A
$I_C @ T_C = 100^\circ C$	Continuous Collector Current	8.0	
$I_{CM}$	Pulsed Collector Current ①	18	
$I_{LM}$	Clamped Inductive Load Current ②	18	
$V_{GE}$	Gate-to-Emitter Voltage	$\pm 20$	V
$E_{ARV}$	Reverse Voltage Avalanche Energy ③	110	mJ
$P_D @ T_C = 25^\circ C$	Maximum Power Dissipation	38	W
$P_D @ T_C = 100^\circ C$	Maximum Power Dissipation	15	
$T_J$	Operating Junction and	-55 to + 150	°C
$T_{STG}$	Storage Temperature Range		
	Soldering Temperature, for 10 seconds	300 (0.063 in. (1.6mm) from case )	

### Thermal Resistance

	Parameter	Typ.	Max.	Units
$R_{\theta JC}$	Junction-to-Case	—	3.3	°C/W
$R_{\theta JA}$	Junction-to-Ambient (PCB mount)*	—	50	
Wt	Weight	0.3 (0.01)	—	g (oz)

\* When mounted on 1" square PCB (FR-4 or G-10 Material).

For recommended footprint and soldering techniques refer to application note #AN-994

www.irf.com

# IRG4RC10SPbF

International  
IR Rectifier

## Electrical Characteristics @ $T_J = 25^\circ\text{C}$ (unless otherwise specified)

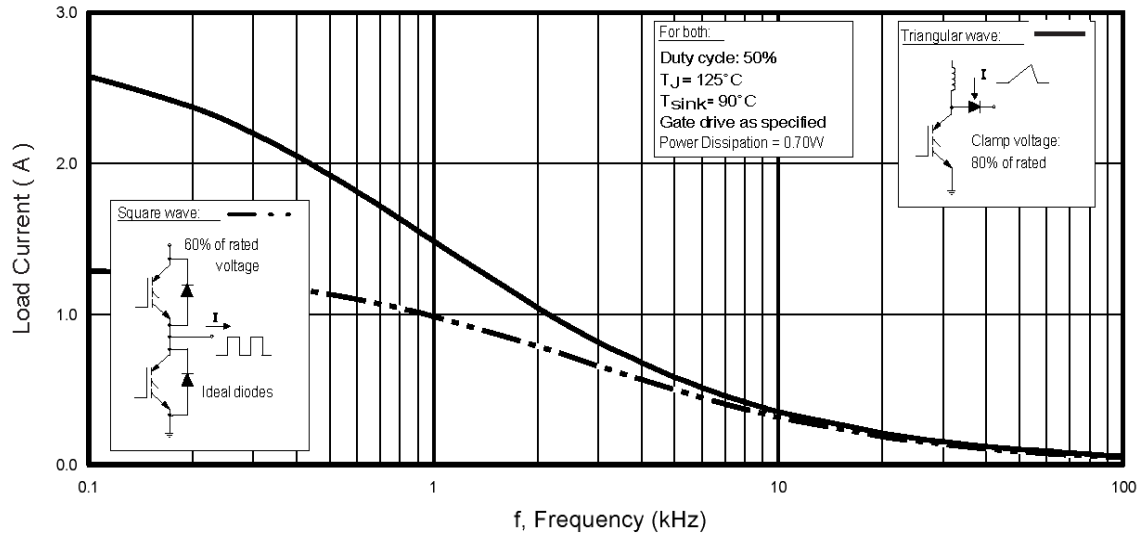
	Parameter	Min.	Typ.	Max.	Units	Conditions
$V_{(BR)CES}$	Collector-to-Emitter Breakdown Voltage	600	—	—	V	$V_{GE} = 0V, I_C = 250\mu A$
$V_{(BR)ECS}$	Emitter-to-Collector Breakdown Voltage ①	18	—	—	V	$V_{GE} = 0V, I_C = 1.0A$
$\Delta V_{(BR)CES}/\Delta T_J$	Temperature Coeff. of Breakdown Voltage	—	0.64	—	V/°C	$V_{GE} = 0V, I_C = 1.0mA$
$V_{CE(ON)}$	Collector-to-Emitter Saturation Voltage	—	1.58	1.8	V	$I_C = 8.0A, V_{GE} = 15V$
		—	2.05	—		$I_C = 14A, V_{GE} = 15V$
		—	1.68	—		$I_C = 8.0A, T_J = 150^\circ\text{C}$
$V_{GE(th)}$	Gate Threshold Voltage	3.0	—	6.0		$V_{CE} = V_{GE}, I_C = 250\mu A$
$\Delta V_{GE(th)}/\Delta T_J$	Temperature Coeff. of Threshold Voltage	—	-9.5	—	mV/°C	$V_{CE} = V_{GE}, I_C = 250\mu A$
$g_{fs}$	Forward Transconductance ②	3.7	5.5	—	S	$V_{CE} = 100V, I_C = 8.0A$
$I_{CES}$	Zero Gate Voltage Collector Current	—	—	250	$\mu A$	$V_{GE} = 0V, V_{CE} = 600V$
		—	—	2.0		$V_{GE} = 0V, V_{CE} = 10V, T_J = 25^\circ\text{C}$
		—	—	1000		$V_{GE} = 0V, V_{CE} = 600V, T_J = 150^\circ\text{C}$
$I_{GES}$	Gate-to-Emitter Leakage Current	—	—	$\pm 100$	nA	$V_{GE} = \pm 20V$

## Switching Characteristics @ $T_J = 25^\circ\text{C}$ (unless otherwise specified)

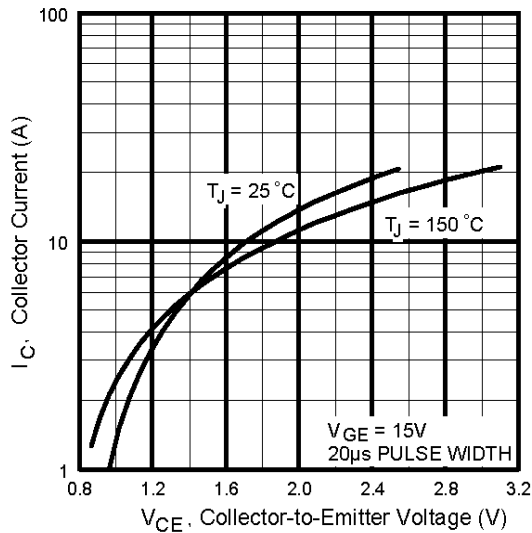
	Parameter	Min.	Typ.	Max.	Units	Conditions
$Q_g$	Total Gate Charge (turn-on)	—	15	22	nC	$I_C = 8.0A$
$Q_{ge}$	Gate - Emitter Charge (turn-on)	—	2.4	3.6		$V_{CC} = 400V$
$Q_{gc}$	Gate - Collector Charge (turn-on)	—	6.5	9.8		$V_{GE} = 15V$
$t_{d(on)}$	Turn-On Delay Time	—	25	—	ns	$T_J = 25^\circ\text{C}$
$t_r$	Rise Time	—	28	—		$I_C = 8.0A, V_{CC} = 480V$
$t_{d(off)}$	Turn-Off Delay Time	—	630	950		$V_{GE} = 15V, R_G = 100\Omega$
$t_f$	Fall Time	—	710	1100	mJ	Energy losses include "tail"
$E_{on}$	Turn-On Switching Loss	—	0.14	—		See Fig. 9, 10, 14
$E_{off}$	Turn-Off Switching Loss	—	2.58	—		
$E_{ts}$	Total Switching Loss	—	2.72	4.3	ns	$T_J = 150^\circ\text{C}$
$t_{d(on)}$	Turn-On Delay Time	—	24	—		$I_C = 8.0A, V_{CC} = 480V$
$t_r$	Rise Time	—	31	—		$V_{GE} = 15V, R_G = 100\Omega$
$t_{d(off)}$	Turn-Off Delay Time	—	810	—	mJ	Energy losses include "tail"
$t_f$	Fall Time	—	1300	—		See Fig. 11, 14
$E_{ts}$	Total Switching Loss	—	3.94	—		
$L_E$	Internal Emitter Inductance	—	7.5	—	nH	Measured 5mm from package
$C_{ies}$	Input Capacitance	—	280	—	pF	$V_{GE} = 0V$
$C_{oes}$	Output Capacitance	—	30	—		$V_{CC} = 30V$
$C_{res}$	Reverse Transfer Capacitance	—	4.0	—		$f = 1.0\text{MHz}$

### Notes:

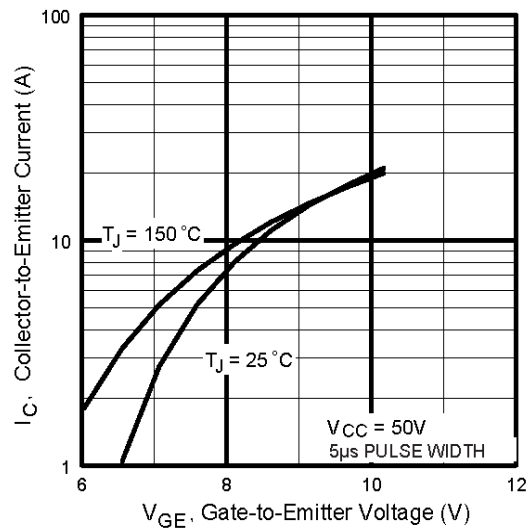
- ① Repetitive rating;  $V_{GE} = 20V$ , pulse width limited by max. junction temperature. ( See fig. 13b )
- ②  $V_{CC} = 80\%(V_{CES}), V_{GE} = 20V, L = 10\mu H, R_G = 100\Omega$ . (See fig. 13a)
- ③ Repetitive rating; pulse width limited by maximum junction temperature.
- ④ Pulse width  $\leq 80\mu s$ ; duty factor  $\leq 0.1\%$ .
- ⑤ Pulse width  $5.0\mu s$ , single shot.



**Fig. 1** - Typical Load Current vs. Frequency  
(Load Current =  $I_{RMS}$  of fundamental)



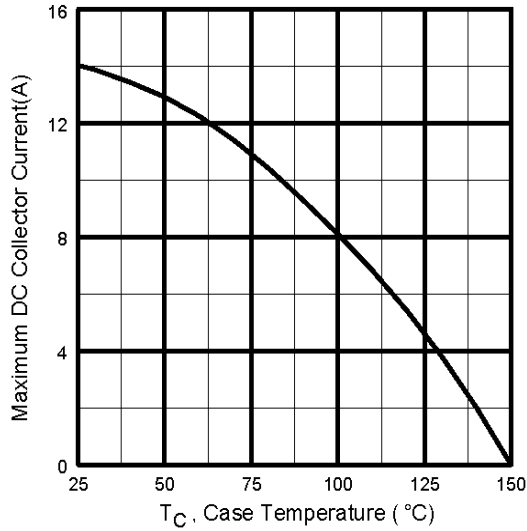
**Fig. 2** - Typical Output Characteristics



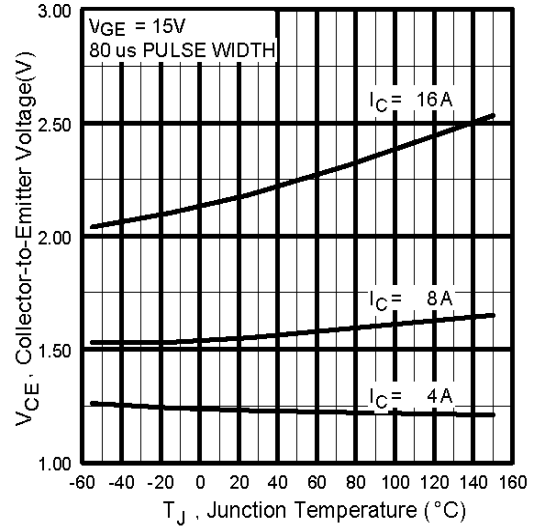
**Fig. 3** - Typical Transfer Characteristics

# IRG4RC10SPbF

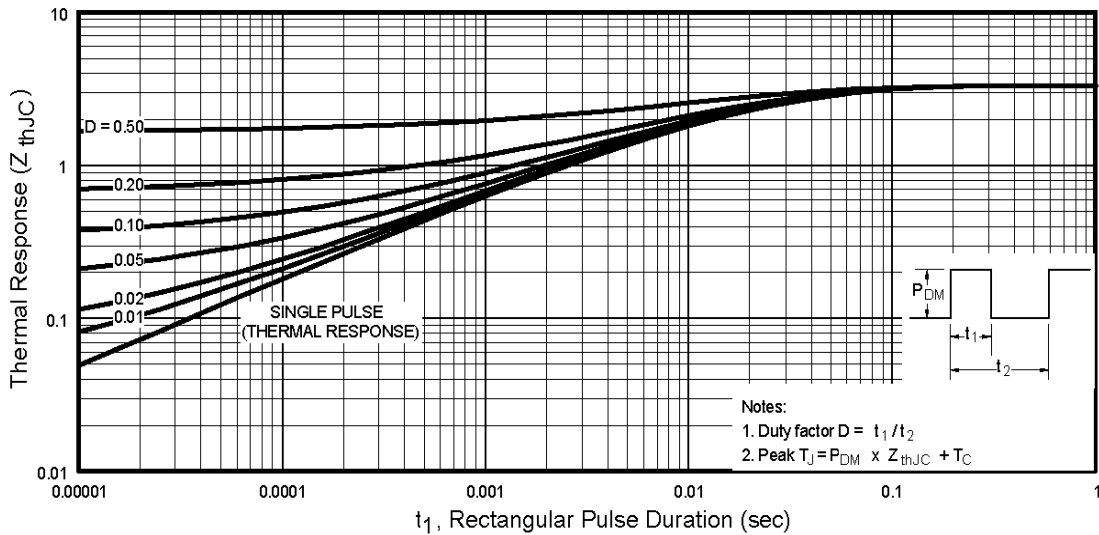
International  
**IR** Rectifier



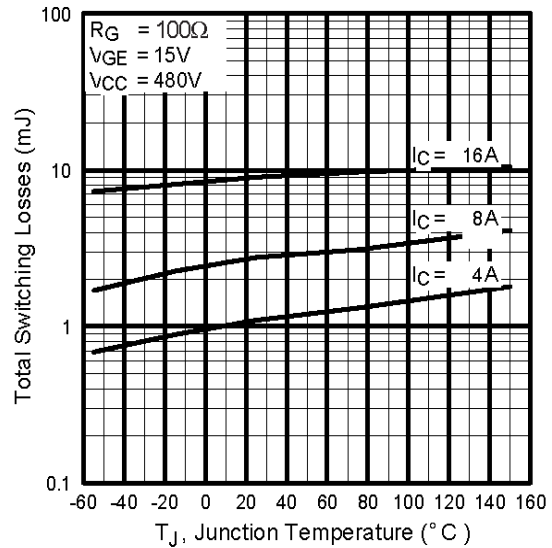
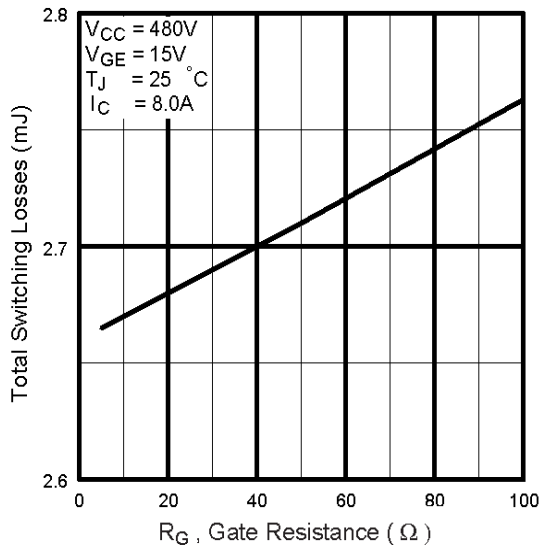
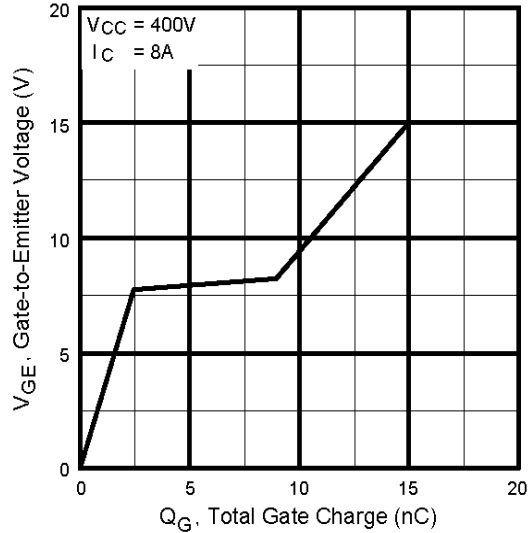
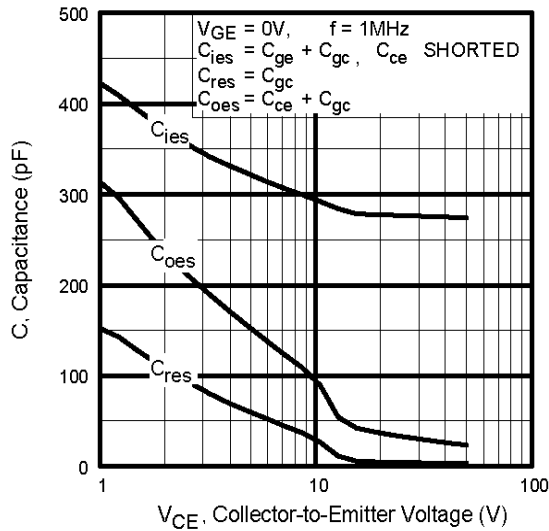
**Fig. 4** - Maximum Collector Current vs. Case Temperature



**Fig. 5** - Typical Collector-to-Emitter Voltage vs. Junction Temperature

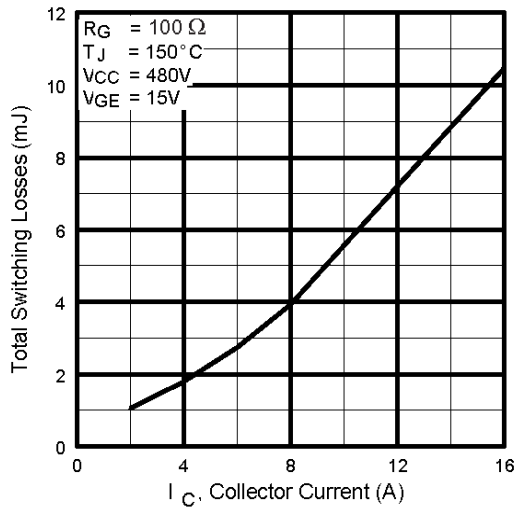


**Fig. 6** - Maximum Effective Transient Thermal Impedance, Junction-to-Case

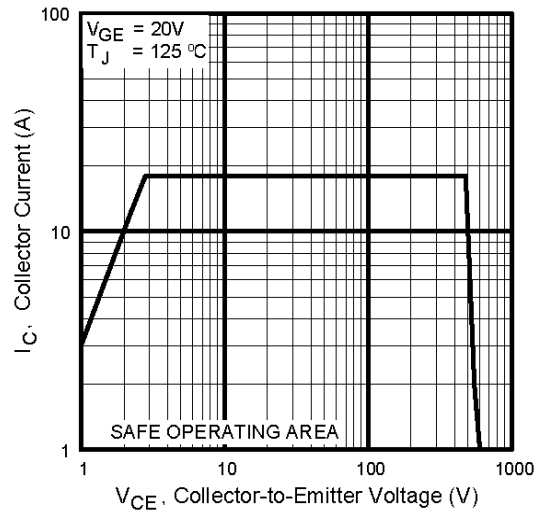


# IRG4RC10SPbF

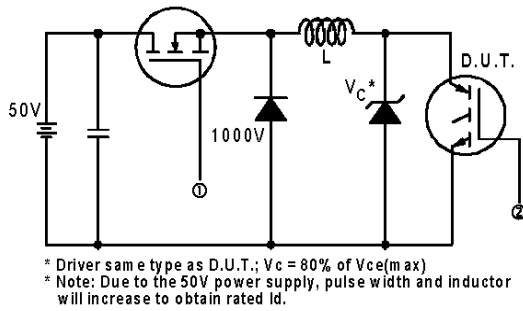
International  
**IR** Rectifier



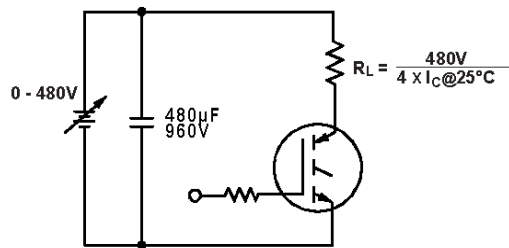
**Fig. 11** - Typical Switching Losses vs. Collector Current



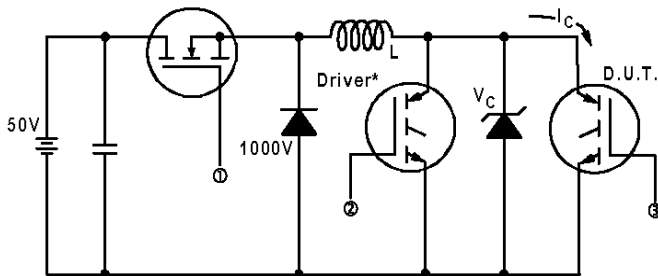
**Fig. 12** - Turn-Off SOA



**Fig. 13a** - Clamped Inductive Load Test Circuit

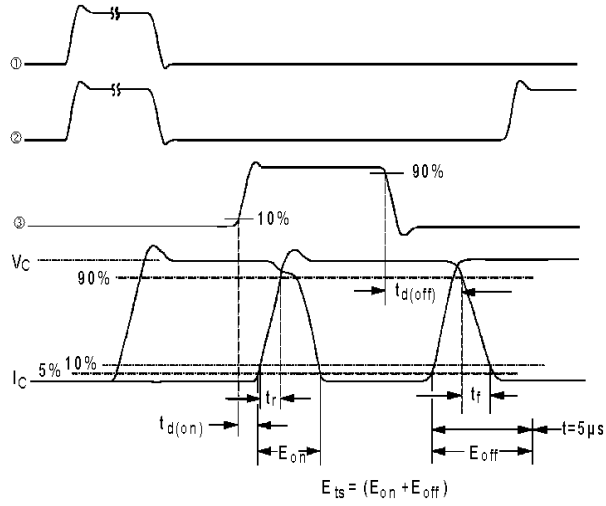


**Fig. 13b** - Pulsed Collector Current Test Circuit



**Fig. 14a** - Switching Loss Test Circuit

\* Driver same type as D.U.T.,  $V_C = 480V$



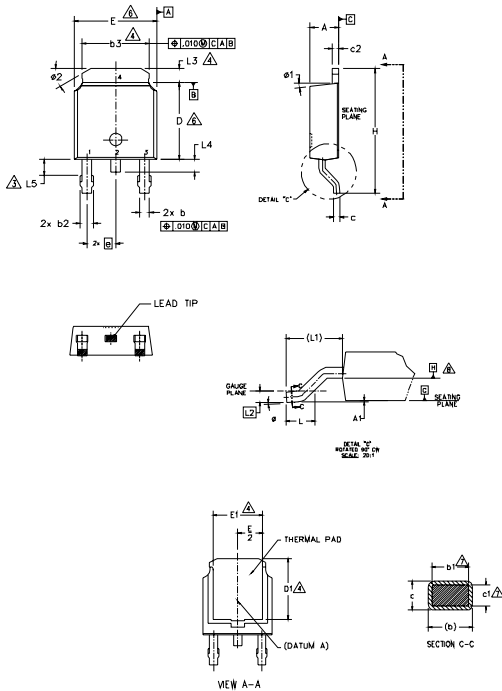
**Fig. 14b** - Switching Loss Waveforms

# IRG4RC10SPbF

International  
**IR** Rectifier

## D-Pak (TO-252AA) Package Outline

Dimensions are shown in millimeters (inches)



- NOTES:
- 1.- DIMENSIONING AND TOLERANCING PER ASME Y14.5M-1994
  - 2.- DIMENSIONS ARE SHOWN IN INCHES [MILLIMETERS]
  - 3.- LEAD DIMENSION UNCONTROLLED IN L5.
  - 4.- DIMENSION D1, E1, L3 & b3 ESTABLISH A MINIMUM MOUNTING SURFACE FOR THERMAL PAD.
  - 5.- SECTION C-C DIMENSIONS APPLY TO THE FLAT SECTION OF THE LEAD BETWEEN .005 AND 0.10 [0.13 AND 0.25] FROM THE LEAD TIP.
  - 6.- DIMENSION D & E DO NOT INCLUDE MOLD FLASH. MOLD FLASH SHALL NOT EXCEED .005 [0.13] PER SIDE. THESE DIMENSIONS ARE MEASURED AT THE OUTMOST EXTREMES OF THE PLASTIC BODY.
  - 7.- DIMENSION b1 & c1 APPLIED TO BASE METAL ONLY.
  - 8.- DATUM A & B TO BE DETERMINED AT DATUM PLANE H.
  - 9.- OUTLINE CONFORMS TO JEDEC OUTLINE TO-252AA.

SYMBOL	DIMENSIONS				NOTES
	MILLIMETERS		INCHES		
	MIN.	MAX.	MIN.	MAX.	
A	2.18	2.39	.086	.094	7
A1	-	0.13	-	.005	
b	0.64	0.89	.025	.035	4
b1	0.65	0.79	.025	.031	
b2	0.76	1.14	.030	.045	6
b3	4.95	5.46	.195	.215	
c	0.46	0.61	.018	.024	4
c1	0.41	0.56	.016	.022	
c2	0.46	0.89	.018	.035	6
D	5.97	6.22	.235	.245	
D1	5.21	-	.205	-	4
E	6.35	6.73	.250	.265	
E1	4.32	-	.170	-	6
e	2.29 BSC		.090 BSC		
H	9.40	10.41	.370	.410	4
L	1.40	1.78	.055	.070	
L1	2.74 BSC		.108 REF.		4
L2	0.51 BSC		.020 BSC		
L3	0.89	1.27	.035	.060	3
L4	-	1.02	-	.040	
L5	1.14	1.52	.045	.060	4
ø	0"	10"	0"	10"	
ø1	0"	15"	0"	15"	4
ø2	25"	35"	25"	35"	

### LEAD ASSIGNMENTS

### HEXFET

- 1.- GATE
- 2.- DRAIN
- 3.- SOURCE
- 4.- DRAIN

### IGBT & CoPAK

- 1.- GATE
- 2.- COLLECTOR
- 3.- EMITTER
- 4.- COLLECTOR

## D-Pak (TO-252AA) Part Marking Information

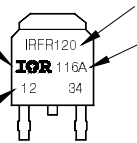
EXAMPLE: THIS IS AN IRFR120  
WITH ASSEMBLY  
LOT CODE 1234  
ASSEMBLED ON WW 16, 2001  
IN THE ASSEMBLY LINE 'A'

Note: 'P' in assembly line position  
indicates 'Lead-Free'

'P' in assembly line position indicates  
'Lead-Free' qualification to the consumer-level

INTERNATIONAL  
RECTIFIER  
LOGO

ASSEMBLY  
LOT CODE

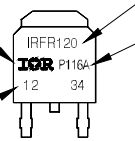


PART NUMBER  
DATE CODE  
YEAR 1 = 2001  
WEEK 16  
LINE A

OR

INTERNATIONAL  
RECTIFIER  
LOGO

ASSEMBLY  
LOT CODE



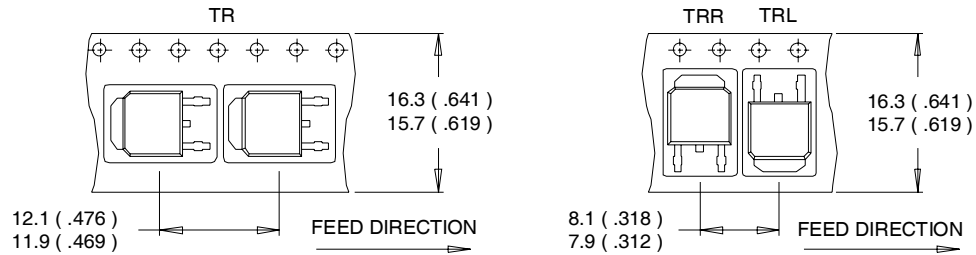
PART NUMBER  
DATE CODE  
P = DESIGNATES LEAD-FREE  
PRODUCT (OPTIONAL)  
P̄ = DESIGNATES LEAD-FREE  
PRODUCT QUALIFIED TO THE  
CONSUMER LEVEL (OPTIONAL)  
YEAR 1 = 2001  
WEEK 16  
A = ASSEMBLY SITE CODE

Note: For the most current drawing please refer to IR website at <http://www.irf.com/package/>



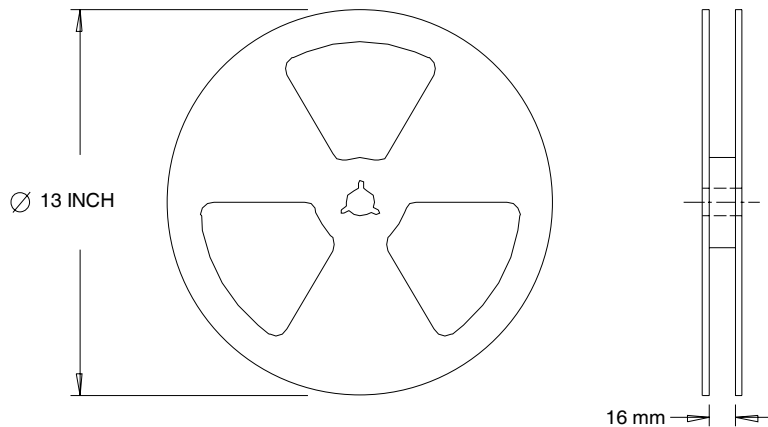
## D-Pak (TO-252AA) Tape & Reel Information

Dimensions are shown in millimeters (inches)



**NOTES :**

1. CONTROLLING DIMENSION : MILLIMETER.
2. ALL DIMENSIONS ARE SHOWN IN MILLIMETERS ( INCHES ).
3. OUTLINE CONFORMS TO EIA-481 & EIA-541.



**NOTES :**

1. OUTLINE CONFORMS TO EIA-481.

**Note:** For the most current drawing please refer to IR website at <http://www.irf.com/package/>

Data and specifications subject to change without notice.