



GAN140-650EBE

650 V, 140 mOhm Gallium Nitride (GaN) FET in a DFN
8 mm x 8 mm package

28 April 2023

Product data sheet

1. General description

The GAN140-650EBE is a general purpose 650 V, 140 mΩ Gallium Nitride (GaN) FET in a DFN 8 mm x 8 mm surface mount package. It is a normally-off e-mode device offering superior performance.

2. Features and benefits

- Enhancement mode - normally-off power switch
- Ultra high frequency switching capability
- No body diode
- Low gate charge, low output charge
- Qualified for standard applications
- ESD protection
- RoHS, Pb-free, REACH-compliant
- High efficiency and high power density
- Low package inductance and low package resistance

3. Applications

- High power density and high efficiency power conversion
- AC-to-DC converters, totem pole PFC
- DC-to-DC converters
- Fast battery charging, mobile phone, laptop, tablet and USB type-C chargers
- Datacom and telecom (AC-to-DC and DC-to-DC) converters
- Motor drives
- Solar (PV) inverters
- Class D audio amplifiers, TV PSU and LED drivers

4. Quick reference data

Table 1. Quick reference data

Symbol	Parameter	Conditions	Min	Typ	Max	Unit
V_{DS}	drain-source voltage	$-55\text{ °C} \leq T_j \leq 150\text{ °C}$	-	-	650	V
V_{TDS}	transient drain to source voltage	pulsed; $t_p = 1\text{ }\mu\text{s}$; $\delta_{factor} = 0.01$	-	-	800	V
I_D	drain current	$V_{GS} = 6\text{ V}$; $T_{mb} = 25\text{ °C}$	[1]	-	17	A
P_{tot}	total power dissipation	$T_{mb} = 25\text{ °C}$; Fig. 1	-	-	113	W
T_j	junction temperature		-55	-	150	°C
Static characteristics						
R_{DSon}	drain-source on-state resistance	$V_{GS} = 6\text{ V}$; $I_D = 5\text{ A}$; $T_j = 25\text{ °C}$; Fig. 11 ; Fig. 12 ; Fig. 13	-	106	140	mΩ
		$V_{GS} = 6\text{ V}$; $I_D = 5\text{ A}$; $T_j = 150\text{ °C}$; Fig. 11 ; Fig. 14	-	230	-	mΩ

650 V, 140 mOhm Gallium Nitride (GaN) FET in a DFN 8 mm x 8 mm package

Symbol	Parameter	Conditions	Min	Typ	Max	Unit
R _G	gate resistance	f = 5 MHz; T _j = 25 °C; open drain	-	3.5	-	Ω
Dynamic characteristics						
Q _{GD}	gate-drain charge	I _D = 5 A; V _{DS} = 400 V; V _{GS} = 6 V; T _j = 25 °C; Fig. 15; Fig. 16	-	1.2	-	nC
Q _{G(tot)}	total gate charge		-	3.5	-	nC
Q _{oss}	output charge	V _{GS} = 0 V; V _{DS} = 400 V; T _j = 25 °C	[2]	33	-	nC

[1] Limited by device saturation

[2] Q_r is not specified separately from Q_{oss} for e-mode GaN FETs, since Q_r = Q_{oss} + Q_D, and Q_D = 0. (Q_D is charge associated with diffusion of minority carriers. Since there is no body diode, no minority carriers in excess of Q_{oss} have to be transferred for e-mode GaN FETs.)

5. Pinning information

Table 2. Pinning information

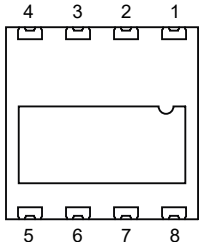
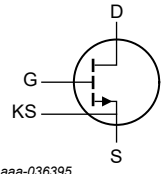
Pin	Symbol	Description	Simplified outline	Graphic symbol
1	D	drain	 <p>Transparent top view</p> <p>DFN8080-8 (SOT8074-1)</p>	 <p>aaa-036395</p>
2	D	drain		
3	D	drain		
4	D	drain		
5	S	source		
6	S	source		
7	KS	kelvin source		
8	G	gate		
mb	S	mounting base; connected to source		

6. Ordering information

Table 3. Ordering information

Type number	Package		Version
	Name	Description	
GAN140-650EBE	DFN8080-8	plastic thermal enhanced small outline package; no leads; 8 terminals; body: 8 x 8 x 0.9 mm	SOT8074-1

7. Marking

Table 4. Marking codes

Type number	Marking code
GAN140-650EBE	140IEBE

8. Limiting values

Table 5. Limiting values

In accordance with the Absolute Maximum Rating System (IEC 60134). T_j = 25 °C unless otherwise stated.

Symbol	Parameter	Conditions	Min	Max	Unit
V _{DS}	drain-source voltage	-55 °C ≤ T _j ≤ 150 °C	-	650	V

650 V, 140 mOhm Gallium Nitride (GaN) FET in a DFN 8 mm x 8 mm package

Symbol	Parameter	Conditions	Min	Max	Unit
V _{TDS}	transient drain to source voltage	pulsed; t _p = 1 μs; δ _{factor} = 0.01	-	800	V
V _{GS}	gate-source voltage		-1.4	7	V
P _{tot}	total power dissipation	T _{mb} = 25 °C; Fig. 1	-	113	W
I _D	drain current	V _{GS} = 6 V; T _{mb} = 25 °C	[1]	17	A
I _{DM}	peak drain current	pulsed; t _p ≤ 10 μs; T _{mb} = 25 °C; Fig. 2	[1]	32	A
T _{stg}	storage temperature		-55	150	°C
T _j	junction temperature		-55	150	°C
T _{slid(M)}	peak soldering temperature		-	260	°C

[1] Limited by device saturation

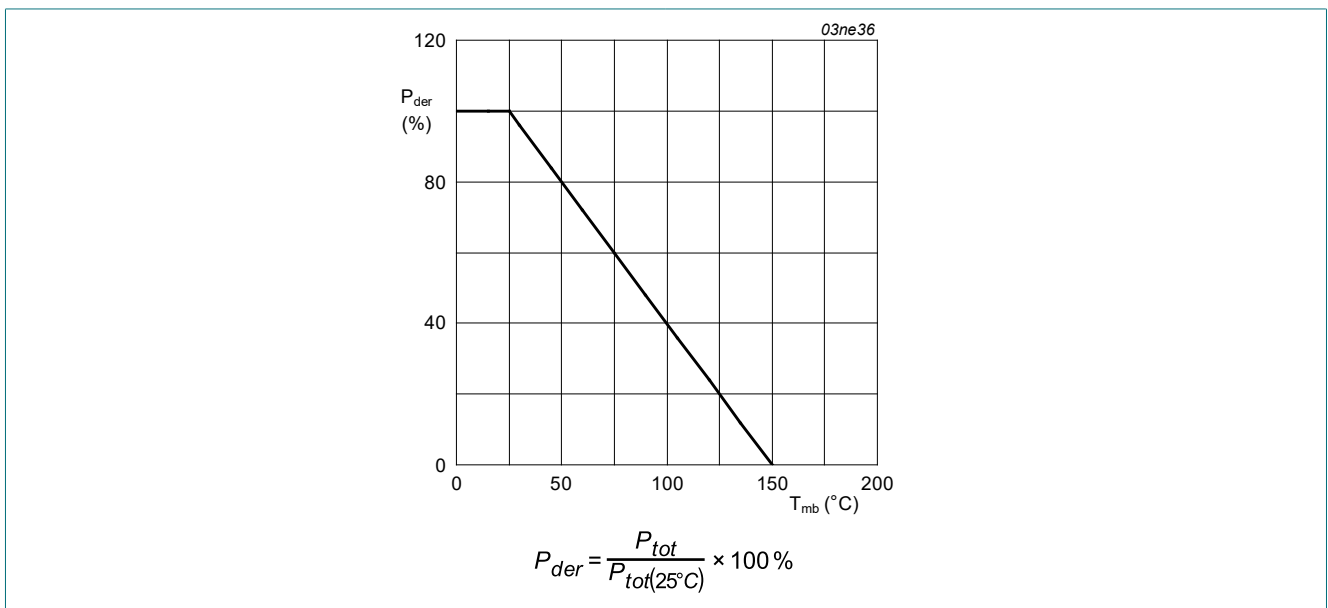

Fig. 1. Normalized total power dissipation as a function of mounting base temperature

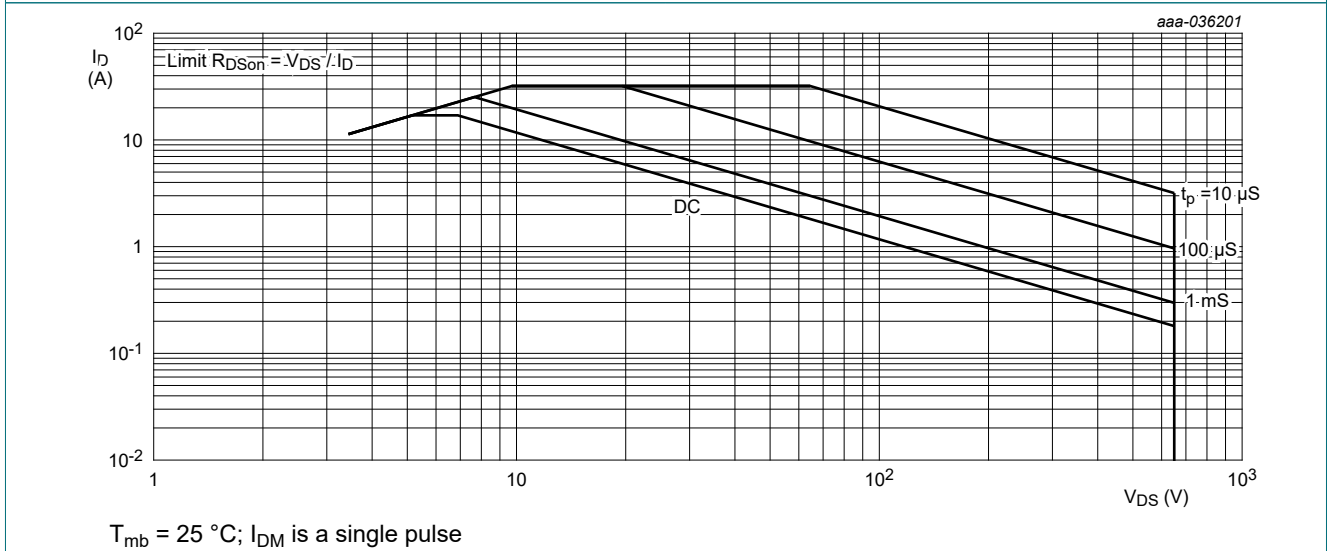

Fig. 2. Safe operating area; continuous and peak drain currents as a function of drain-source voltage

9. Thermal characteristics

Table 6. Thermal characteristics

Symbol	Parameter	Conditions	Min	Typ	Max	Unit
$R_{th(j-c)}$	thermal resistance from junction to case	Fig. 3	-	-	1.1	K/W
$R_{th(j-a)}$	thermal resistance from junction to ambient		-	-	60.3	K/W

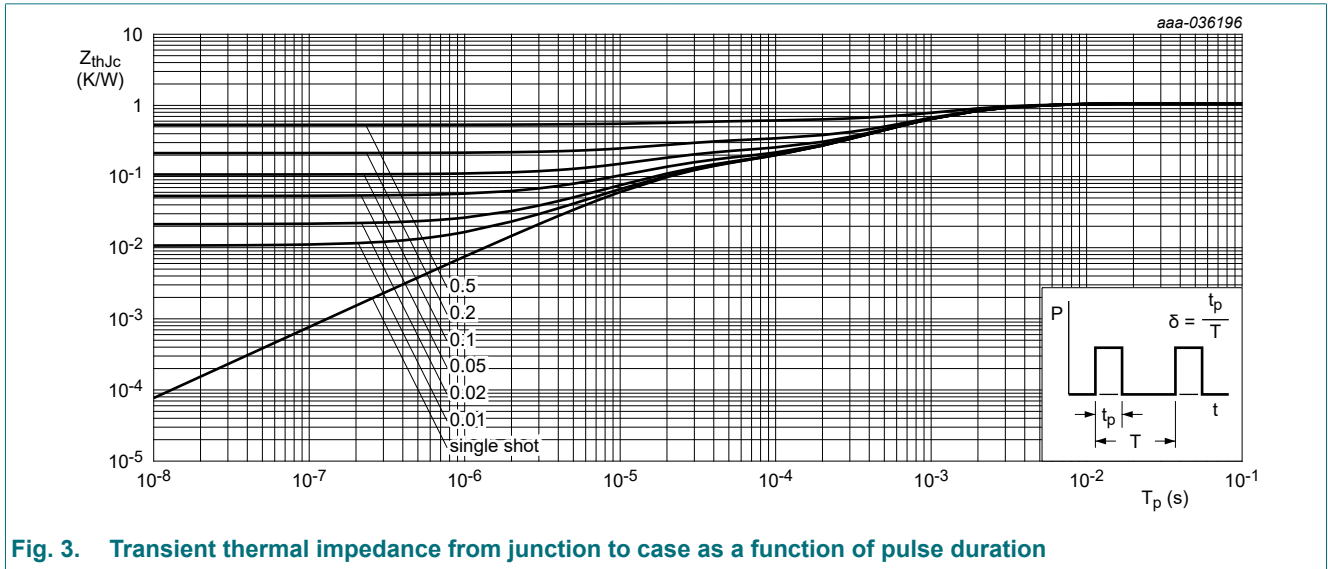

Fig. 3. Transient thermal impedance from junction to case as a function of pulse duration

10. Characteristics

Table 7. Characteristics

Symbol	Parameter	Conditions	Min	Typ	Max	Unit
Static characteristics						
$V_{GS(th)}$	gate-source threshold voltage	$I_D = 17.2 \text{ mA}; V_{DS} = V_{GS}; T_j = 25 \text{ }^\circ\text{C};$ Fig. 8	1.2	1.7	2.5	V
		$I_D = 17.2 \text{ mA}; V_{DS} = V_{GS}; T_j = 150 \text{ }^\circ\text{C};$ Fig. 8	-	1.7	-	V
I_{DSS}	drain leakage current	$V_{DS} = 650 \text{ V}; V_{GS} = 0 \text{ V}; T_j = 25 \text{ }^\circ\text{C};$ Fig. 9	-	0.6	25	μA
		$V_{DS} = 650 \text{ V}; V_{GS} = 0 \text{ V}; T_j = 150 \text{ }^\circ\text{C};$ Fig. 9	-	7	-	μA
I_{GSS}	gate leakage current	$V_{GS} = 6 \text{ V}; V_{DS} = 0 \text{ V}; T_j = 25 \text{ }^\circ\text{C};$ Fig. 10	-	70	-	μA
$R_{DS(on)}$	drain-source on-state resistance	$V_{GS} = 6 \text{ V}; I_D = 5 \text{ A}; T_j = 25 \text{ }^\circ\text{C};$ Fig. 11; Fig. 12; Fig. 13	-	106	140	m Ω
		$V_{GS} = 6 \text{ V}; I_D = 5 \text{ A}; T_j = 150 \text{ }^\circ\text{C};$ Fig. 11; Fig. 14	-	230	-	m Ω
R_G	gate resistance	$f = 5 \text{ MHz}; T_j = 25 \text{ }^\circ\text{C};$ open drain	-	3.5	-	Ω
Dynamic characteristics						
$Q_{G(tot)}$	total gate charge	$I_D = 5 \text{ A}; V_{DS} = 400 \text{ V}; V_{GS} = 6 \text{ V};$ $T_j = 25 \text{ }^\circ\text{C};$ Fig. 15; Fig. 16	-	3.5	-	nC
Q_{GS}	gate-source charge		-	0.3	-	nC
Q_{GD}	gate-drain charge		-	1.2	-	nC

650 V, 140 mOhm Gallium Nitride (GaN) FET in a DFN 8 mm x 8 mm package

Symbol	Parameter	Conditions	Min	Typ	Max	Unit
$V_{GS(pl)}$	gate-source plateau voltage	$I_D = 5\text{ A}$; $V_{DS} = 400\text{ V}$; $T_j = 25\text{ }^\circ\text{C}$; Fig. 15	-	2.1	-	V
C_{iss}	input capacitance	$V_{DS} = 400\text{ V}$; $V_{GS} = 0\text{ V}$; $f = 100\text{ kHz}$; $T_j = 25\text{ }^\circ\text{C}$; Fig. 17	-	125	-	pF
C_{oss}	output capacitance		-	41	-	pF
C_{rss}	reverse transfer capacitance		-	0.4	-	pF
$C_{o(er)}$	effective output capacitance, energy related	$0\text{ V} \leq V_{DS} \leq 400\text{ V}$; $V_{GS} = 0\text{ V}$; $T_j = 25\text{ }^\circ\text{C}$; Fig. 18	[1]	-	59	pF
$C_{o(tr)}$	effective output capacitance, time related	$0\text{ V} \leq V_{DS} \leq 400\text{ V}$; $V_{GS} = 0\text{ V}$; $T_j = 25\text{ }^\circ\text{C}$	[2]	-	82	pF
$t_{d(on)}$	turn-on delay time	$V_{DS} = 400\text{ V}$; $V_{GS} = 6\text{ V}$; $T_j = 25\text{ }^\circ\text{C}$; $I_D = 10\text{ A}$; $L = 318\text{ }\mu\text{H}$; $R_{on} = 10\text{ }\Omega$; $R_{off} = 2\text{ }\Omega$; Fig. 19 ; Fig. 20	-	3	-	ns
t_r	rise time		-	5	-	ns
$t_{d(off)}$	turn-off delay time		-	4	-	ns
t_f	fall time		-	4	-	ns
Q_{oss}	output charge	$V_{GS} = 0\text{ V}$; $V_{DS} = 400\text{ V}$; $T_j = 25\text{ }^\circ\text{C}$	[3]	-	33	nC
Source-drain characteristics						
V_{SD}	source-drain voltage	$I_S = 5\text{ A}$; $V_{GS} = 0\text{ V}$; $T_j = 25\text{ }^\circ\text{C}$; Fig. 21 ; Fig. 22 ; Fig. 23 ; Fig. 24	-	2.4	-	V

- [1] $C_{O(er)}$ is the fixed capacitance that gives the same stored energy as C_{OSS} while V_{DS} is rising from 0 to 400 V
- [2] $C_{O(tr)}$ is the fixed capacitance that gives the same charging time as C_{OSS} while V_{DS} is rising from 0 to 400 V
- [3] Q_r is not specified separately from Q_{oss} for e-mode GaN FETs, since $Q_r = Q_{oss} + Q_D$, and $Q_D = 0$. (Q_D is charge associated with diffusion of minority carriers. Since there is no body diode, no minority carriers in excess of Q_{oss} have to be transferred for e-mode GaN FETs.)

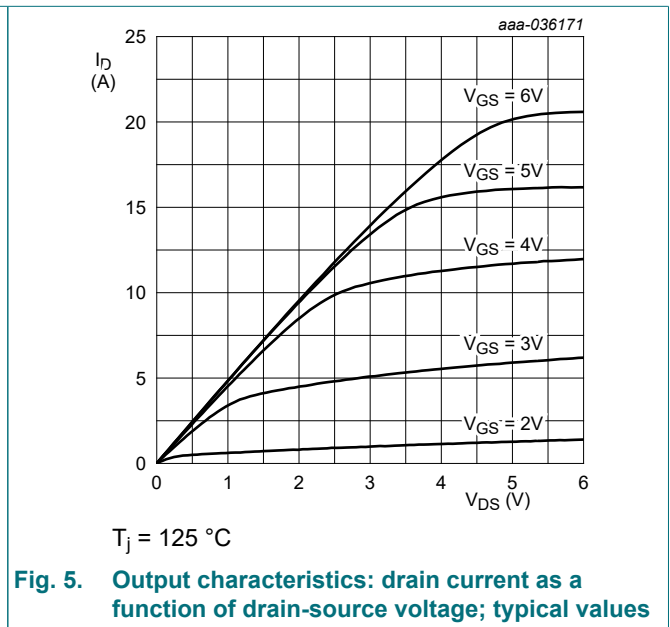
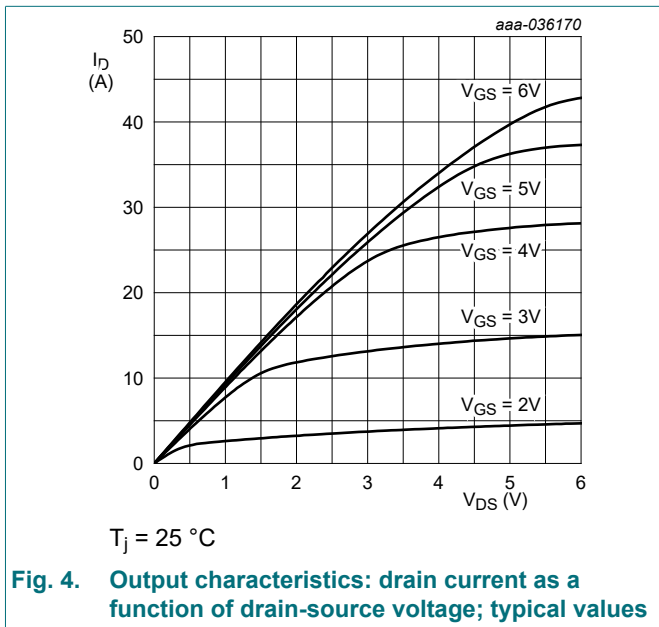

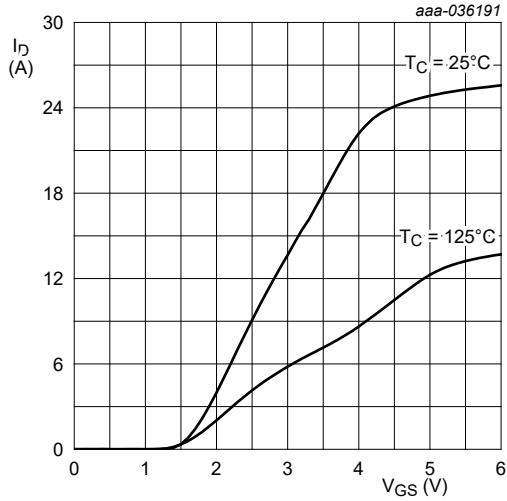
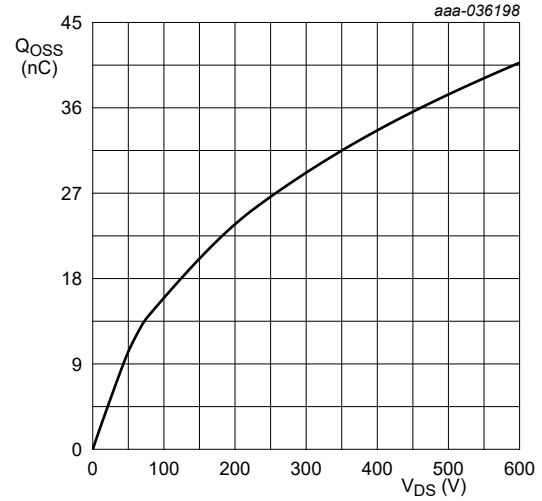
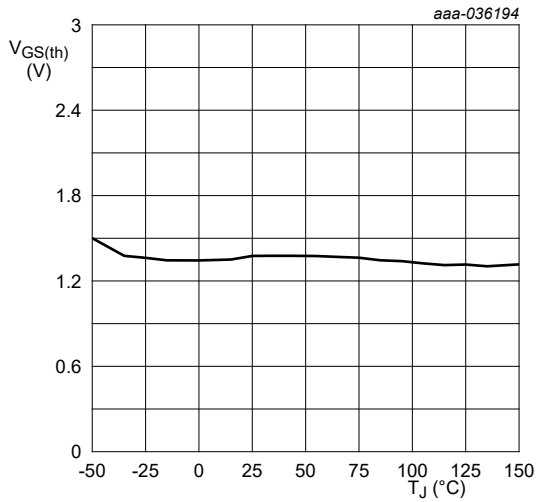

Fig. 6. Transfer characteristics; drain current as a function of gate-source voltage; typical values



Freq. = 100 kHz

Fig. 7. Output charge as a function of drain-source voltage; typical values



$I_D = 17.2\text{ mA}$; $V_{DS} = V_{GS}$

Fig. 8. Gate-source threshold voltage as a function of junction temperature

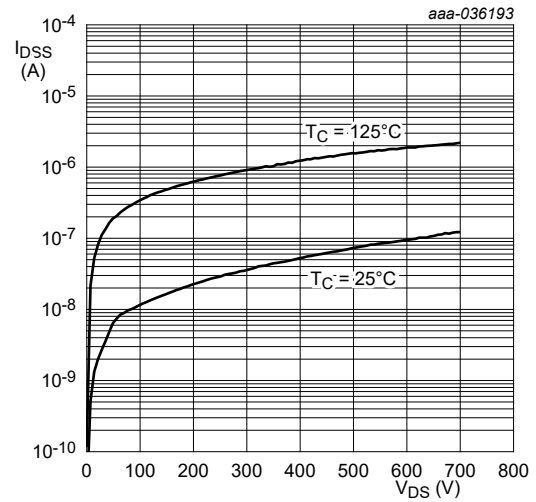

$V_{GS} = 0\text{ V}$

Fig. 9. Drain-source current as a function of drain-source voltage; typical values

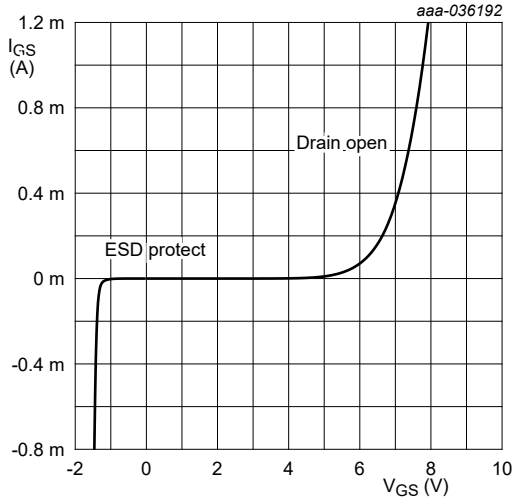

I_g reverse turn on by ESD unit

Fig. 10. Gate-source current as a function of gate-source voltage; typical values

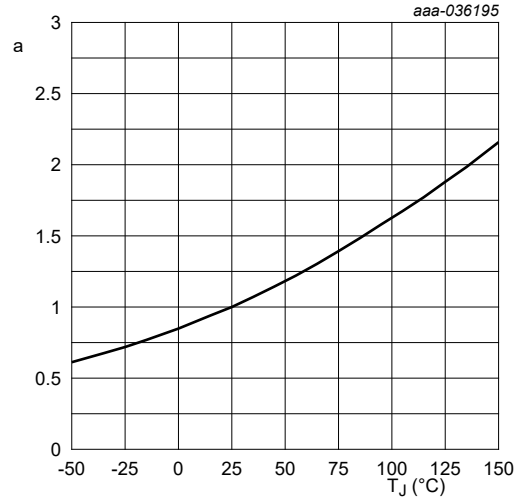

$$a = \frac{R_{DSon}}{R_{DSon}(25^{\circ}C)}$$

Fig. 11. Normalized drain-source on-state resistance factor as a function of junction temperature

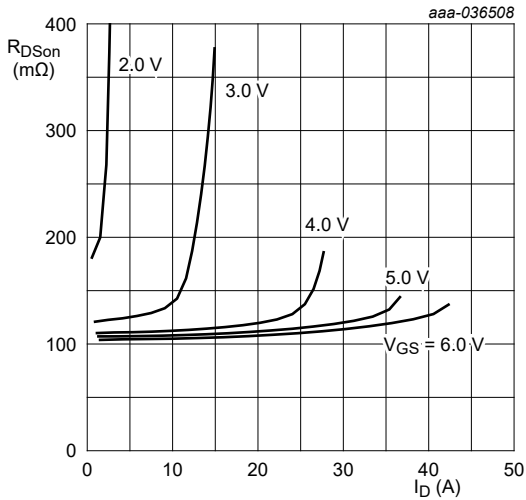

T_j = 25 °C

Fig. 12. Drain-source on-state resistance as a function of drain current ; typical values

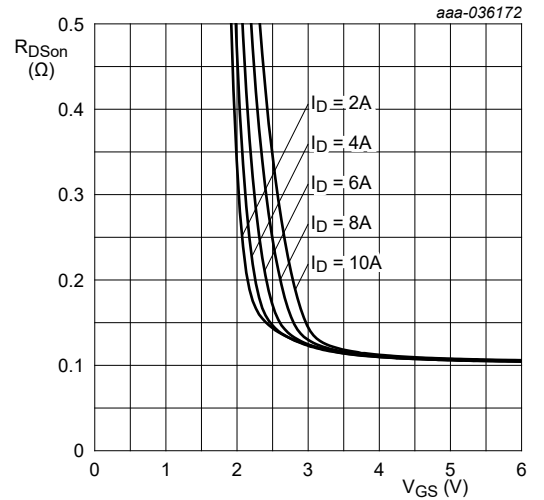

T_j = 25 °C

Fig. 13. Drain-source on-state resistance as a function of gate-source voltage; typical values

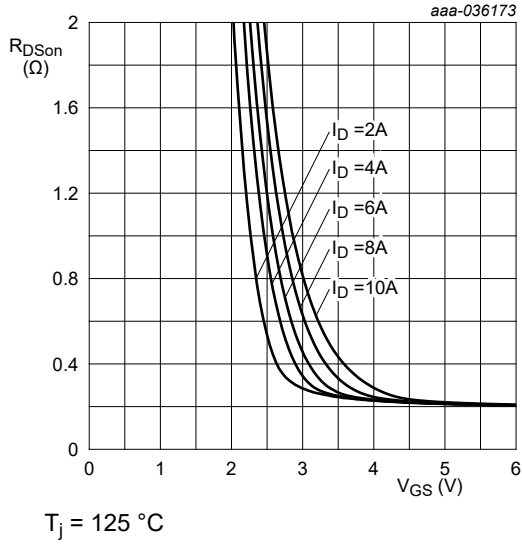

Fig. 14. Drain-source on-state resistance as a function of gate-source voltage; typical values

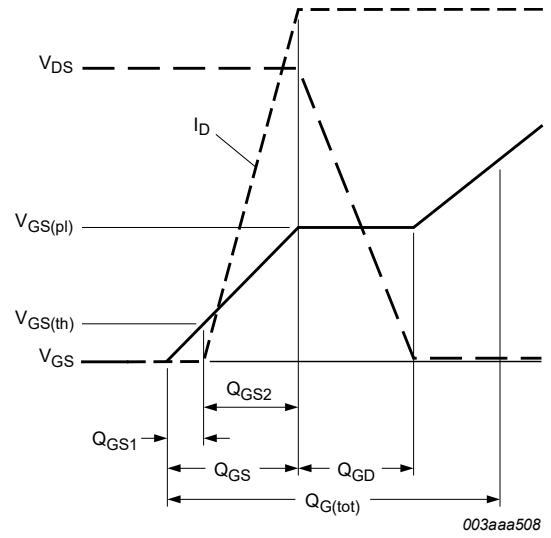

Fig. 15. Gate charge waveform definitions

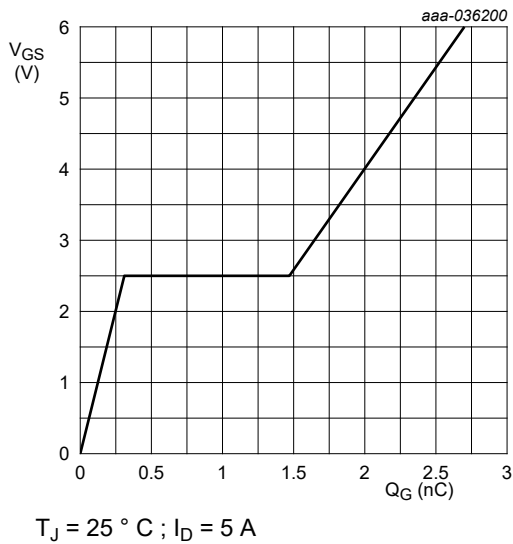

Fig. 16. Gate-source voltage as a function of gate charge; typical values

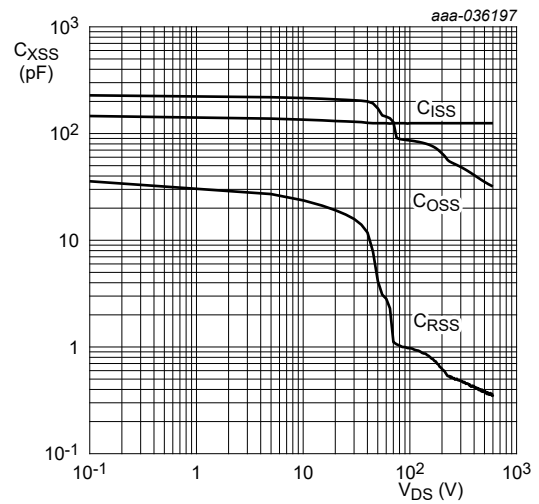
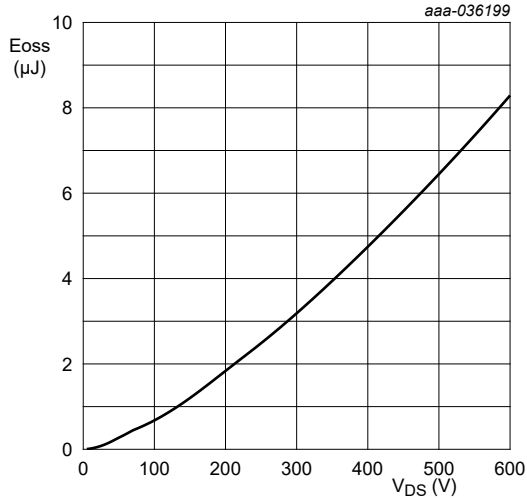
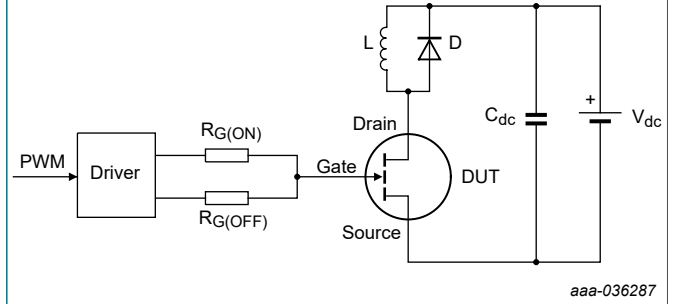

Fig. 17. Input, output and reverse transfer capacitances as a function of drain-source voltage; typical values



Freq. = 100 kHz

Fig. 18. COSS stored energy as a function of drain-source voltage; typical values



$V_{DS} = 400\text{ V}$; $I_D = 10\text{ A}$; $L = 318\text{ }\mu\text{H}$; $V_{GS} = 6\text{ V}$;
 $R_{on} = 10\text{ }\Omega$; $R_{off} = 2\text{ }\Omega$

Fig. 19. Typical switching times with inductive load

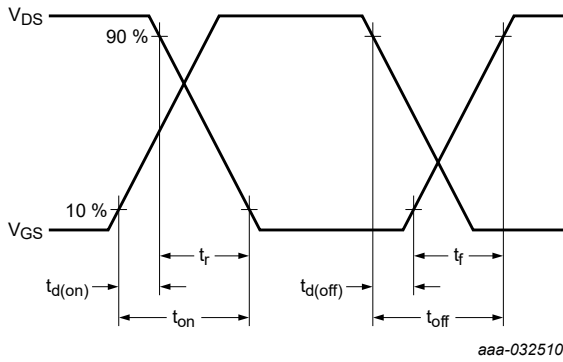
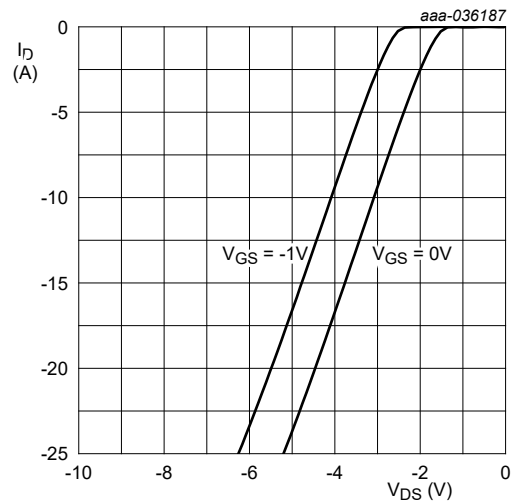

Fig. 20. Switching time waveform



$T_j = 25\text{ }^\circ\text{C}$

Fig. 21. Source current as a function of source-drain voltage; typical values

650 V, 140 mOhm Gallium Nitride (GaN) FET in a DFN 8 mm x 8 mm package

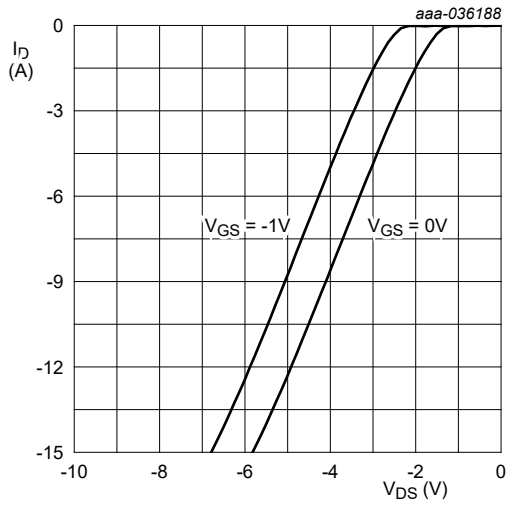

$T_j = 125\text{ °C}$

Fig. 22. Source current as a function of source-drain voltage; typical values

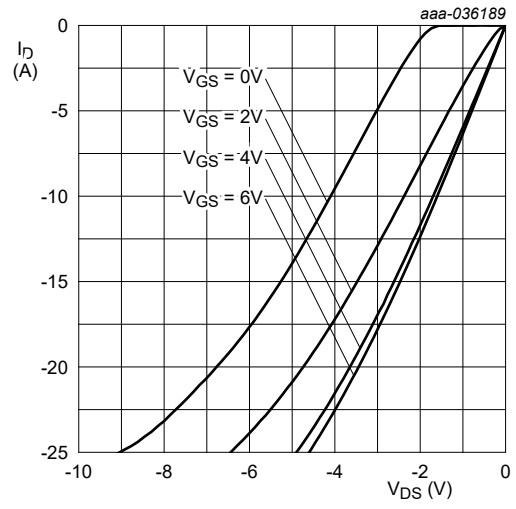

$T_j = 25\text{ °C}$

Fig. 23. Source current as a function of source-drain voltage; typical values

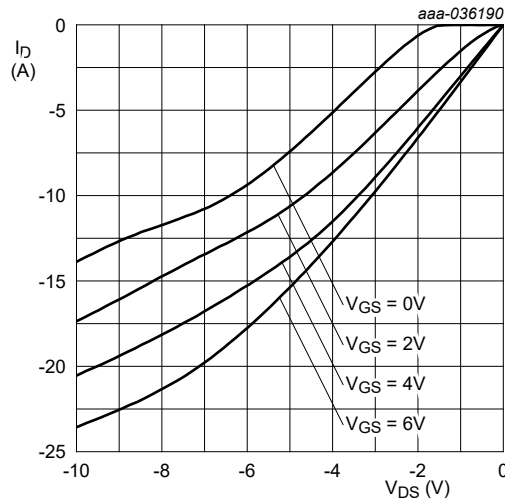

$T_j = 125\text{ °C}$

Fig. 24. Source current as a function of source-drain voltage; typical values

11. Package outline

DFN8080-8: plastic thermal enhanced small outline package; no leads; 8 terminals; body: 8 × 8 × 0.9 mm

SOT8074-1

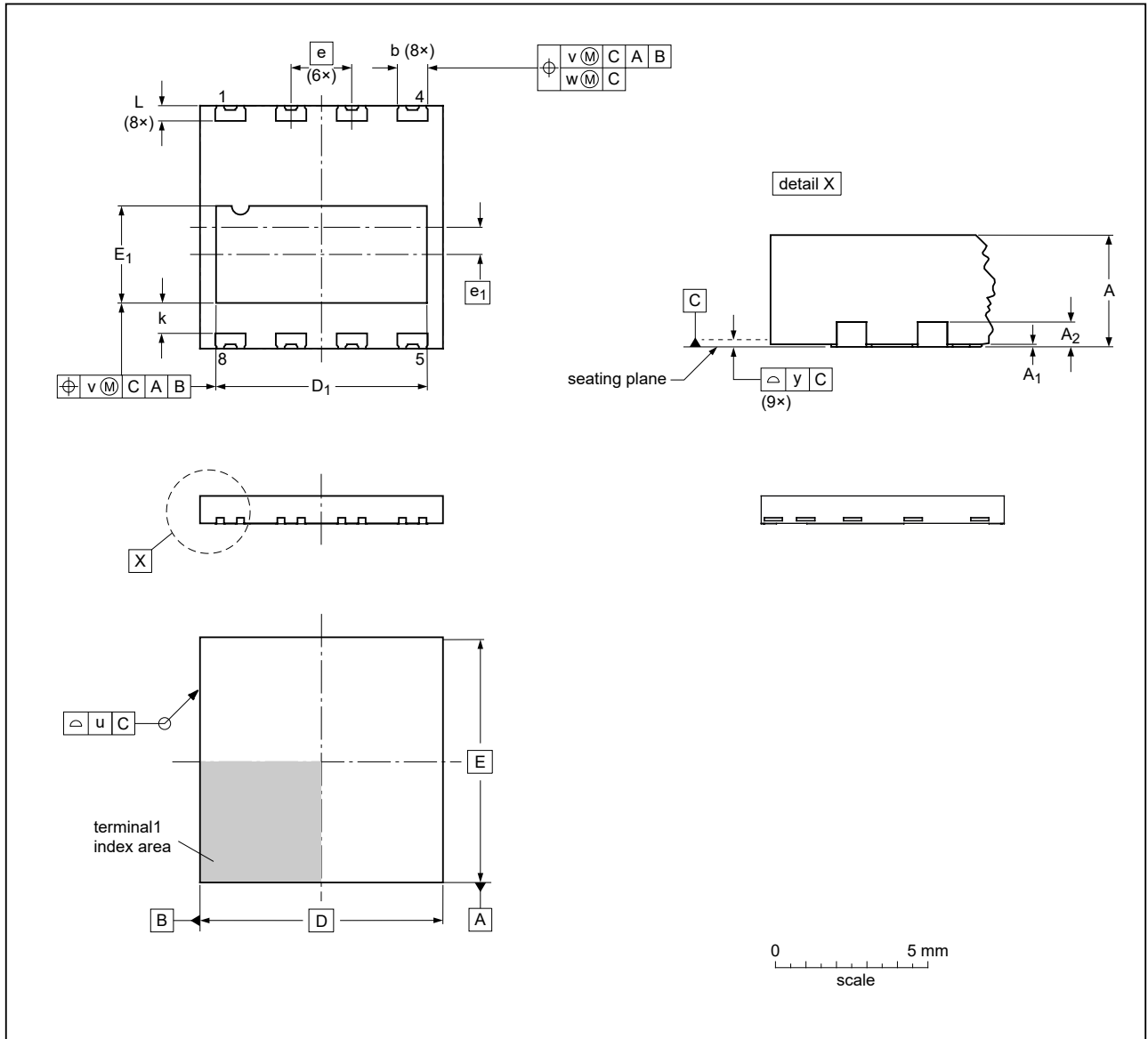

Dimensions (mm are the original dimensions)

Unit	A	A ₁	A ₂	b	D	D ₁	E	E ₁	e	e ₁	k	L	y	u	v	w
max	1.0	0.05	0.203	1.05	8	7.04	8	3.3	2	0.9	1	0.6	0.1	0.1	0.1	0.05
nom	0.9	0.02	REF	1.00	BSC	6.94	BSC	3.2	BSC	BSC	REF	0.4				
min	0.8	0.00		0.92		6.84		3.1								

sot8074-1_po

Outline version	References				European projection	Issue date
	IEC	JEDEC	JEITA			
SOT8074-1		MO-229 compatible				23-03-03

Fig. 25. Package outline DFN8080-8 (SOT8074-1)

12. Soldering

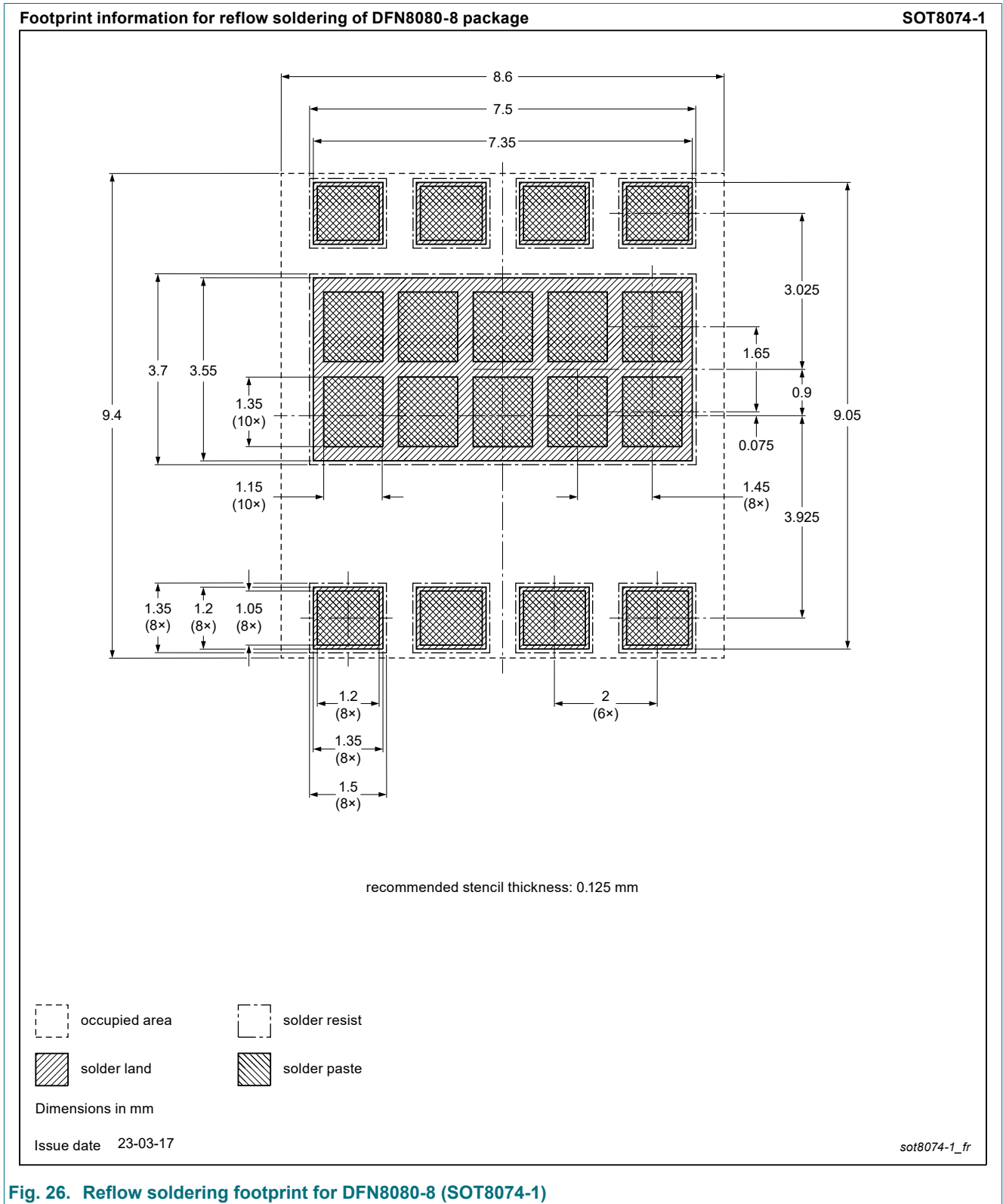

Fig. 26. Reflow soldering footprint for DFN8080-8 (SOT8074-1)

13. Legal information

Data sheet status

Document status [1][2]	Product status [3]	Definition
Objective [short] data sheet	Development	This document contains data from the objective specification for product development.
Preliminary [short] data sheet	Qualification	This document contains data from the preliminary specification.
Product [short] data sheet	Production	This document contains the product specification.

- [1] Please consult the most recently issued document before initiating or completing a design.
- [2] The term 'short data sheet' is explained in section "Definitions".
- [3] The product status of device(s) described in this document may have changed since this document was published and may differ in case of multiple devices. The latest product status information is available on the internet at <https://www.nexperia.com>.

Definitions

Draft — The document is a draft version only. The content is still under internal review and subject to formal approval, which may result in modifications or additions. Nexperia does not give any representations or warranties as to the accuracy or completeness of information included herein and shall have no liability for the consequences of use of such information.

Short data sheet — A short data sheet is an extract from a full data sheet with the same product type number(s) and title. A short data sheet is intended for quick reference only and should not be relied upon to contain detailed and full information. For detailed and full information see the relevant full data sheet, which is available on request via the local Nexperia sales office. In case of any inconsistency or conflict with the short data sheet, the full data sheet shall prevail.

Product specification — The information and data provided in a Product data sheet shall define the specification of the product as agreed between Nexperia and its customer, unless Nexperia and customer have explicitly agreed otherwise in writing. In no event however, shall an agreement be valid in which the Nexperia product is deemed to offer functions and qualities beyond those described in the Product data sheet.

Disclaimers

Limited warranty and liability — Information in this document is believed to be accurate and reliable. However, Nexperia does not give any representations or warranties, expressed or implied, as to the accuracy or completeness of such information and shall have no liability for the consequences of use of such information. Nexperia takes no responsibility for the content in this document if provided by an information source outside of Nexperia.

In no event shall Nexperia be liable for any indirect, incidental, punitive, special or consequential damages (including - without limitation - lost profits, lost savings, business interruption, costs related to the removal or replacement of any products or rework charges) whether or not such damages are based on tort (including negligence), warranty, breach of contract or any other legal theory.

Notwithstanding any damages that customer might incur for any reason whatsoever, Nexperia's aggregate and cumulative liability towards customer for the products described herein shall be limited in accordance with the Terms and conditions of commercial sale of Nexperia.

Right to make changes — Nexperia reserves the right to make changes to information published in this document, including without limitation specifications and product descriptions, at any time and without notice. This document supersedes and replaces all information supplied prior to the publication hereof.

Suitability for use — Nexperia products are not designed, authorized or warranted to be suitable for use in life support, life-critical or safety-critical systems or equipment, nor in applications where failure or malfunction of an Nexperia product can reasonably be expected to result in personal

injury, death or severe property or environmental damage. Nexperia and its suppliers accept no liability for inclusion and/or use of Nexperia products in such equipment or applications and therefore such inclusion and/or use is at the customer's own risk.

Quick reference data — The Quick reference data is an extract of the product data given in the Limiting values and Characteristics sections of this document, and as such is not complete, exhaustive or legally binding.

Applications — Applications that are described herein for any of these products are for illustrative purposes only. Nexperia makes no representation or warranty that such applications will be suitable for the specified use without further testing or modification.

Customers are responsible for the design and operation of their applications and products using Nexperia products, and Nexperia accepts no liability for any assistance with applications or customer product design. It is customer's sole responsibility to determine whether the Nexperia product is suitable and fit for the customer's applications and products planned, as well as for the planned application and use of customer's third party customer(s). Customers should provide appropriate design and operating safeguards to minimize the risks associated with their applications and products.

Nexperia does not accept any liability related to any default, damage, costs or problem which is based on any weakness or default in the customer's applications or products, or the application or use by customer's third party customer(s). Customer is responsible for doing all necessary testing for the customer's applications and products using Nexperia products in order to avoid a default of the applications and the products or of the application or use by customer's third party customer(s). Nexperia does not accept any liability in this respect.

Limiting values — Stress above one or more limiting values (as defined in the Absolute Maximum Ratings System of IEC 60134) will cause permanent damage to the device. Limiting values are stress ratings only and (proper) operation of the device at these or any other conditions above those given in the Recommended operating conditions section (if present) or the Characteristics sections of this document is not warranted. Constant or repeated exposure to limiting values will permanently and irreversibly affect the quality and reliability of the device.

Terms and conditions of commercial sale — Nexperia products are sold subject to the general terms and conditions of commercial sale, as published at <http://www.nexperia.com/profile/terms>, unless otherwise agreed in a valid written individual agreement. In case an individual agreement is concluded only the terms and conditions of the respective agreement shall apply. Nexperia hereby expressly objects to applying the customer's general terms and conditions with regard to the purchase of Nexperia products by customer.

No offer to sell or license — Nothing in this document may be interpreted or construed as an offer to sell products that is open for acceptance or the grant, conveyance or implication of any license under any copyrights, patents or other industrial or intellectual property rights.

Export control — This document as well as the item(s) described herein may be subject to export control regulations. Export might require a prior authorization from competent authorities.

Non-automotive qualified products — Unless this data sheet expressly states that this specific Nexperia product is automotive qualified, the product is not suitable for automotive use. It is neither qualified nor tested in accordance with automotive testing or application requirements. Nexperia accepts no liability for inclusion and/or use of non-automotive qualified products in automotive equipment or applications.

In the event that customer uses the product for design-in and use in automotive applications to automotive specifications and standards, customer (a) shall use the product without Nexperia's warranty of the product for such automotive applications, use and specifications, and (b) whenever customer uses the product for automotive applications beyond Nexperia's specifications such use shall be solely at customer's own risk, and (c) customer fully indemnifies Nexperia for any liability, damages or failed product claims resulting from customer design and use of the product for automotive applications beyond Nexperia's standard warranty and Nexperia's product specifications.

Translations — A non-English (translated) version of a document is for reference only. The English version shall prevail in case of any discrepancy between the translated and English versions.

Trademarks

Notice: All referenced brands, product names, service names and trademarks are the property of their respective owners.

Contents

1. General description.....	1
2. Features and benefits.....	1
3. Applications.....	1
4. Quick reference data.....	1
5. Pinning information.....	2
6. Ordering information.....	2
7. Marking.....	2
8. Limiting values.....	2
9. Thermal characteristics.....	4
10. Characteristics.....	4
11. Package outline.....	11
12. Soldering.....	12
13. Legal information.....	13

© Nexperia B.V. 2023. All rights reserved

For more information, please visit: <http://www.nexperia.com>

For sales office addresses, please send an email to: salesaddresses@nexperia.com

Date of release: 28 April 2023
