



TILT – 57A

DYNAMIC INCLINOMETER

Three-Axis Accelerometer

Three-Axis Gyroscope



CTi SENSOR, INC.

Document Revision 1.4

CTi SENSORS TECHNICAL DOCUMENT

This is our product specific technical data sheet. The following information is available to assist CTi Sensors customers in product development.

TECHNICAL SUPPORT CONTACT INFO

Website: <http://ctisensors.com/contact-us/>

Email: info@ctisensors.com

Phone: (440) 264-2370

TABLE OF CONTENTS

1. INTRODUCTION.....	4
1.1 FEATURES	4
1.2 APPLICATIONS.....	4
2. SPECIFICATIONS	5
2.1. ANGLES	5
2.2. ACCELEROMETER.....	5
2.3. GYROSCOPE.....	5
2.4. SYSTEM	6
2.5. MECHANICAL.....	6
2.6. SHOCK AND VIBRATION	6
3. TERMINAL ASSIGNMENT.....	7
4. WINCTI-TILT SOFTWARE	8
5. SERIAL INTERFACE AND DATA FORMAT	9
6. 8-BIT CHECKSUM.....	10
7. MESSAGE HEADER	10
8. CONFIGURATION COMMANDS.....	11
9. DIMENSIONAL DRAWING.....	13
10. HORIZONTAL INSTALLATION POSITION	13
11. PART NUMBER	14
12. WIRED CABLES	15
13. REVISION HISTORY	16

1. Introduction

A **Dynamic Inclinometer** is an instrument for measuring angles of slope (or tilt), elevation or depression of an object with respect to gravity while it is not in stationary condition. As motion, vibration and shocks (external acceleration) will introduce errors in the tilt measurements, dynamic inclinometers (or tilt meters) often benefit from an on-board gyroscope and fusion algorithm which combines gyroscope and accelerometer data to rectify errors introduced by external accelerations.

The **TILT-57A** Dynamic Inclinometer series are high performance, high resolution dual axis dynamic inclinometers that use the latest miniature MEMS sensor technology.

1.1 Features

- High-accuracy, dual-axis dynamic tilt sensor
- Measuring range: Pitch: $\pm 90^\circ$, Roll: $\pm 180^\circ$
- Static accuracy: $\leq 0.03^\circ$ (typical)
- High resolution: $< 0.003^\circ$
- Ultra-low noise: $0.001^\circ/\sqrt{\text{Hz}}$
- Very low temperature offset drift: $\pm 0.002^\circ/\text{C}$ (typical)
- Highest output data rate: up to 2 kHz
- Three-axis accelerometer and three-axis gyroscope data
- Simple ASCII interface language
- Several interface options including UART, RS232, RS422, RS485
- IP 67 compliant connector, cable and housing
- Robust aluminum housing
- Low power consumption: 400 mW (80 mA @ 5 V)

1.2 Applications

- Motion and dynamics measurements
- Dynamic platform alignment and stabilization
- Vehicle control: marine, robotics, automotive
- Inertial navigation and GPS compensation
- Agricultural and industrial vehicle tilt monitoring

2. Specifications

2.1. Angles

Table 1. Angles

Parameter	Value
Range	Pitch: $\pm 90^\circ$, roll: $\pm 180^\circ$
Static accuracy	$\leq 0.03^\circ$ RMS (typical @20°C)
Dynamic accuracy	$\leq 0.5^\circ$ RMS (typical)
Dynamic accuracy under vibration (standard: MIL-STD-202H, table 6)	Error $\leq 0.15^\circ$ RMS
Angular resolution	$\leq 0.003^\circ$
Noise density	$0.001^\circ/\sqrt{\text{Hz}}$
Zero offset error (pitch and roll)	$< \pm 0.02^\circ$ (@20°C)
Offset change versus temperature	$\pm 0.002^\circ/\text{C}$ (typical)

2.2. Accelerometer

Table 2. Accelerometer

Parameter	Value
Range	$\pm 2 \text{ g}/\pm 4 \text{ g}/\pm 8 \text{ g}$ selectable
Zero offset error	$< \pm 0.5 \text{ mg}$ (@20°C)
In-run bias stability	X & Y: $< 5 \mu\text{g}$, Z: $< 10 \mu\text{g}$
Velocity random walk	X & Y: $0.007 \text{ m/sec}/\sqrt{\text{hr}}$, Z: $0.011 \text{ m/sec}/\sqrt{\text{hr}}$
Nonlinearity	$\pm 0.1 \%$ FS
Bias change versus temperature	$\pm 0.02 \text{ mg}/\text{C}$ (typical)
Noise density	$25 \mu\text{g}/\sqrt{\text{Hz}}$ (@200Hz)
Resonant frequency	2.4 kHz

2.3. Gyroscope

Table 3. Gyroscope

Parameter	Value
Range	$\pm 125/250/500/1000/2000^\circ/\text{s}$ selectable
In-run bias stability	$10^\circ/\text{hr}$
Angle random walk	$0.35^\circ/\sqrt{\text{hr}}$
Initial bias error	$< 0.1^\circ/\text{s}$ (@ $\pm 500^\circ/\text{s}$ range)
Noise density	$0.007 \text{ dps}/\sqrt{\text{Hz}}$ (@ 10 Hz)
Nonlinearity	0.1% FS
g- sensitivity	$0.1^\circ/\text{s}/\text{g}$
Bias change versus temperature	X and Y: $< \pm 0.01^\circ/\text{s}/\text{C}$ (in-run compensated), Z: $\pm 0.025^\circ/\text{s}/\text{C}$

2.4. System

Table 4. System

Parameter	Value
Power source	4.1-38 VDC
Power consumption	400 mW (80 mA @ 5 V)
Data format	ASCII Port settings: 1 start bit, 8 data bits, 1 stop bit, no parity
Baud rate	2.4kbps – 921.6kbps selectable default: 115.2kbps
Output data rate	1 Hz to 2 kHz selectable
GUI software	WinCTi-Tilt-57®
Serial interface options	RS232, RS422, RS485, UART/USB RS485 with multi-drop networking capability
LED indicators	Green: CPU heartbeat, Flashing at 1 Hz Red: Data transmission rate, Flashing at current data rate
Temperature sensor resolution	0.2°C

2.5. Mechanical

Table 5. Mechanical

Parameter	Value
Protection	IP 67 (housing, connector and cable)
Dimension	1.65" x 2.15" x 1.00"
Material (cable is optional as a third-party product)	Enclosure: anodized aluminum Connector: brass/nickel Cable molded head: TPU Cable carrier: TPU or nylon Conductor insulation: PVC
Temperature range	-40°C to +85°C (-40°F to +185°F)
Connection ¹	Cable gland connector M8, 6-contact (female)

2.6. Shock and Vibration

Table 6. Shock and Vibration (Powered and Unpowered)

Parameter	Standard	Value
Shock	MIL-STD-202H (Method 213)	Test Condition F: Half-Sine, 3 Positive and 3 Negative in each direction 0.5 ms 2000 g
Random Vibration	MIL-STD-202H (Method 214)	Test Condition A: 50-2000Hz 15 min/axis Overall RMS: 5.35 g

¹ For details about the cable please see section 12.

3. Terminal Assignment

Table 7. Terminal Assignment

Connector	Wireless	RS232/UART/USB ¹	RS422	RS485	Wire Color
Pin 1	+Vin	+Vin	+Vin	+Vin	Brown
Pin 2	GND	GND	GND	GND	White
Pin 3	–	TX	TX+	D+	Blue
Pin 4	–	–	TX-	D-	Black
Pin 5	–	RX	RX+	D+	Gray
Pin 6	–	–	RX-	D-	Pink

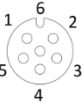
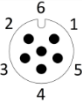
	Device: M 8 – 6-contact (female)	Cable: M 8 – 6-pin (male)	
---	-------------------------------------	------------------------------	---

¹ USB uses UART interface and a UART to USB cable.

4. WinCTi-Tilt Software

WinCTi-Tilt is a graphical user interface (GUI) software provided by CTi Sensor Inc. for visualization aid, device configuration, and data logging. WinCTi-Tilt is designed to be intuitive to users. The package can be downloaded from the CTi Sensors website.

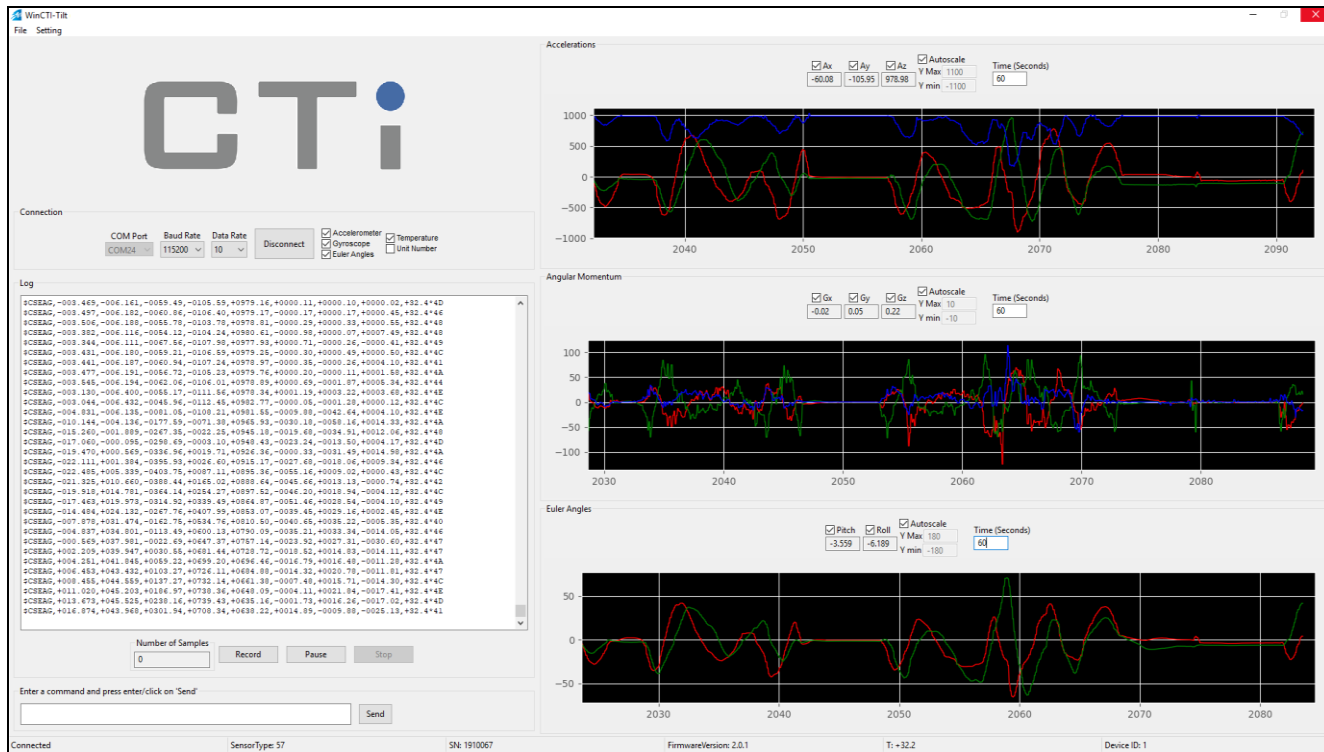

5. Serial Interface and Data Format

TILT–57A uses the following ASCII format, very similar to the widely used NMEA 0183 protocol, for data output:

- Inclinometer message: $\$CSEAG, U, \alpha_x, \alpha_y, A_x, A_y, A_z, G_x, G_y, G_z, T * CC <CR> <LF>$

Which:

U: Device unit number

α_x, α_y : Pitch and roll angles in degrees, horizontal installation

A_x, A_y, A_z : X, Y and Z accelerations in milli g (three-axis accelerometer data)

G_x, G_y, G_z : X, Y and Z angular velocities in deg/s (three-axis gyroscope data)

T: Internal temperature in degrees Centigrade

CC: Checksum (Two ASCII characters)

<CR> <LF>: Carriage return, and line feed characters

Example:

```
$CSEAG, 1, -001.348, +000.023, -0023.54, +0000.41, +1000.15, +0000.01, +0000.01,
-0000.06, +28.8*5A
```

Within the inclinometer message, the temperature, accelerometer, gyroscope, or angle portion of the message may be turned on or off. See Section 8 for specific commands.

The inclinometer message may run in full at an output data rate of up to 500 Hz. With only 2 of the 3 data message portions turned on (accelerometer, gyroscope or angles), the inclinometer message may be run at an output data rate of up to 1 kHz. With only 1 of the 3 message portions turned on, the inclinometer message may be run at an output data rate of up to 2 kHz. When running at 1kHz and 2kHz, it is recommended that the other message portions (temperature and unit number) be turned off if they are not needed.

Because the updated data rate is always saved into the device's flash memory, but the updated baud rate is not, it is possible to create a scenario where the data rate is too high for the baud rate to support. This will not damage the sensor, but it may print gibberish to the screen. To prevent this problem, if selected data rate is greater than 100 Hz, it is recommended to save the baud rate to the flash memory or change the data rate to lower number before disconnecting the sensor. The baud rate can be saved to the flash memory with the command "[nBFW<cr>" (without the quotes). If one encounters this problem, it can easily be remedied by setting a lower data rate, i.e., "[1D10<cr>" (so long as the baud rate matches that of the sensor, commands will go through).

6. 8-bit Checksum

The checksum is calculated by XORing bitwise all bytes (each character is represented by 1 byte) between the \$ and * (not including the \$ or * characters) based on the NMEA standard. It results in two hexadecimal characters, which are sent in ASCII format.

The code for calculating and checking the checksum is as follows:

```
unsigned char cti_checksum(unsigned char * msg)
{
    unsigned int i;
    unsigned char crc = 0;
    for (i = 0; i < strlen((char *)msg); i++)
        crc ^= msg[i];
    return crc;
}
```

7. Message Header

The header of the inclinometer message will change depending on its contents. Portions of the inclinometer message can be turned on and off with commands seen in the Configuration Commands section on the next page.

Table 8. Message header

Header	Angles	Accelerometer	Gyroscope
\$CSEAG	On	On	On
\$CSNAG	Off	On	On
\$CSENG	On	Off	On
\$CSEAN	On	On	Off
\$CSNNG	Off	Off	On
\$CSNAN	Off	On	Off
\$CSENN	On	Off	Off
\$CSNNN	Off	Off	Off

8. Configuration Commands

The TILT-57A uses a simple command format which allows the user to change the device configuration and request specific information or data. All commands start with a '[' character, and end with a carriage return character. All responses end with a carriage return and newline character. The table below shows the list of the interface commands for the TILT-57A series.

In the table below, the lowercase 'n' represents the unit number, which is set to 1 by default, and can be set by the user to any number from 1 to 9. The lowercase letters 'm', 'x', and 'y' represent variable inputs that can be used to set the properties of the device. The lowercase letter 'd' represents variable outputs. In the commands, uppercase letters and other characters do not change.

Table 9. Interface Commands for TILT-57

Command	Description	Response	Description
[<u>n</u> <cr>	Ping unit number n	>! <u>n</u>	Acknowledge ping
[N?<cr>	Request unit number	>Unit Number: <u>n</u>	Returns unit number, default: n=1
[<u>n</u> # <u>m</u> <cr>	Change unit number from n to m, 1 ≤ m ≤ 9	>New Unit Number: <u>m</u>	n=old unit number, m=new unit number, default: n=1
[<u>n</u> #FW<cr>	Save current unit number into flash memory as the new default.	>Default Unit Number set to <u>n</u> . Changes Written to Flash Memory.	Unit number will be changed permanently, and current unit number will be saved into the flash memory as the default unit number. PLEASE BE CAREFUL WHEN USING THIS COMMAND.
[<u>n</u> V<cr>	Request firmware version	>Firmware Version: d.d.d	Returns firmware version
[<u>n</u> S<cr>	Request serial number	>Device <u>n</u> Serial Number: <u>dddddd</u>	Returns 7-digit serial number
[<u>n</u> B <u>xxxx</u> <cr>	Set baud rate: xxx = 2:2400, 4:4800, 9:9600, 19:19200, 38:38400, 57:57600, 115:115200, 230:230400, 460:460800, 921:921600 (bps)	>Change to new Baud Rate: <u>dddddd</u>	Selected baud rate should support current data rate. Otherwise, baud rate will not be changed. Default baud rate is 115200 bps.
[<u>n</u> D <u>xxxxx</u> <cr>	Set data rate: xxx = 1, 2, 5, 10, 20, 25, 40, 50, 100, 200, 400, 1000, 2000 Hz	>New Output Data Rate: <u>ddd</u>	New data rate will be saved into the flash memory. Default data rate is 2 Hz.
[<u>n</u> BFW<cr>	Save current baud rate to flash memory as the new default.	>Current Baud Rate, <u>dddddd</u> , was written into flash memory as the default Baud Rate!	Baud rate will be changed permanently, and be saved into the flash memory. PLEASE BE CAREFUL WHEN USING THIS COMMAND.
[<u>n</u> AR <u>x</u> <cr>	Set accelerometer measurement range: x = ±2, ±4, ±8 g	>New Accelerometer Range: +/- <u>d</u> g	New accelerometer range will be saved into the flash memory (default: ±4 g).
[<u>n</u> AR?<cr>	Request accelerometer measurement range.	>Accelerometer Range: +/- <u>d</u> g	Default range is ± 4g.
[<u>n</u> GR <u>x</u> <cr>	Set gyroscope measurement range: x = 0: 2000, 1: 1000, 2: 500, 3: 250, 4: 125 °/s	>New Gyroscope Range: +/- <u>ddd</u> deg/sec	New gyroscope range will be saved into the flash memory (default: ±500 °/s).
[<u>n</u> GR?<cr>	Request gyroscope measurement range.	>Gyroscope Range: +/- <u>ddd</u> deg/sec	Default range is ± 500 °/sec.
[<u>n</u> ZA<cr>	Set g offset correction to 0 for X and Y axes.	>Accelerometer Zero Offset Adjusted: X Offset: <u>ddd.d</u> , Y Offset: <u>ddd.d</u>	Current values of Ax and Ay will be saved into the flash memory as the zero g offset.

Continued...

Command	Description	Response	Description
[<u>n</u> ALPF <u>x</u> <cr>	Set accelerometer low pass filter bandwidth (Hz): x = 0:1, 1:2, 2:4, 3:8, 4:16, 5:31, 6:62, 7:125, 8:250, 9:500, 10:1000	>Accelerometer low pass filter bandwidth: <u>dddd</u> Hz	Default filter bandwidth is 31 Hz. New low pass filter bandwidth will be saved into flash memory.
[<u>n</u> ALPF?<cr>	Request accelerometer low pass filter bandwidth.	>Accelerometer low pass filter bandwidth: <u>dddd</u> Hz	Default filter bandwidth is 31 Hz.
[<u>n</u> GLPF <u>x</u> <cr>	Set gyroscope low pass filter bandwidth (Hz): x = 0:11, 1:21, 2:40, 3:75, 4:137, 5:255, 6:524, 7:890	>Gyroscope low pass filter bandwidth: <u>ddd</u> Hz	Default filter bandwidth is 40 Hz. New low pass filter bandwidth will be saved into flash memory.
[<u>n</u> GLPF?<cr>	Request gyroscope low pass filter setting.	>Gyroscope low pass filter bandwidth: <u>ddd</u> Hz	Default filter bandwidth is 40 Hz.
[<u>n</u> MAV <u>x</u> <cr>	Toggle internal averaging: x = N: Averaging On x = F: Averaging Off	>Data output averaging filter is ON/OFF	Averaging selection on output data will be saved into flash memory. Default is ON.
[<u>n</u> MIy<cr>	Output message ON/OFF y = S: single message y = C: Continuous message y = X: Message off	>Send one Message Or >Send continuous Message Or >Message OFF	Example for inclinometer data: [1MIS: Sends out one data message [1MIC: Continuously sends out data message [1MIX: Stops sending out data message
[<u>n</u> UNF <u>x</u> <cr>	Unit number message portion ON/OFF x = 0: Off x = 1: On	>Unit number portion of data turned ON/OFF in message.	For optimal performance, should be turned off when the sensor is running at 1kHz or 2kHz.
[<u>n</u> ANF <u>x</u> <cr>	Accelerometer message portion ON/OFF x = 0: Off x = 1: On	>Accelerometer portion of data turned ON/OFF in message.	Only 1 of 3 data messages can be turned on for sensor to run at 2kHz. Only 2 of 3 messages can be turned on for the sensor to run at 1kHz.
[<u>n</u> GNF <u>x</u> <cr>	Gyroscope message portion ON/OFF x = 0: Off x = 1: On	>Gyroscope portion of data turned ON/OFF in message.	Only 1 of 3 data messages can be turned on for sensor to run at 2kHz. Only 2 of 3 messages can be turned on for the sensor to run at 1kHz.
[<u>n</u> ENF <u>x</u> <cr>	Pitch/roll message portion ON/OFF x = 0: Off x = 1: On	>Euler angles portion of data turned ON/OFF in message.	Only 1 of 3 data messages can be turned on for sensor to run at 2kHz. Only 2 of 3 messages can be turned on for the sensor to run at 1kHz.
[<u>n</u> TNF <u>x</u> <cr>	Temperature message portion ON/OFF x = 0: Off x = 1: On	>Temperature portion of data turned ON/OFF in message.	For optimal performance, should be turned off when the sensor is running at 1kHz or 2kHz.
[<u>n</u> MICFW<cr>	Save output message ON/OFF status into flash memory	>Current ON/OFF message status was written into flash memory as the default status!	Current message ON/OFF status will be saved into flash memory.

9. Dimensional Drawing

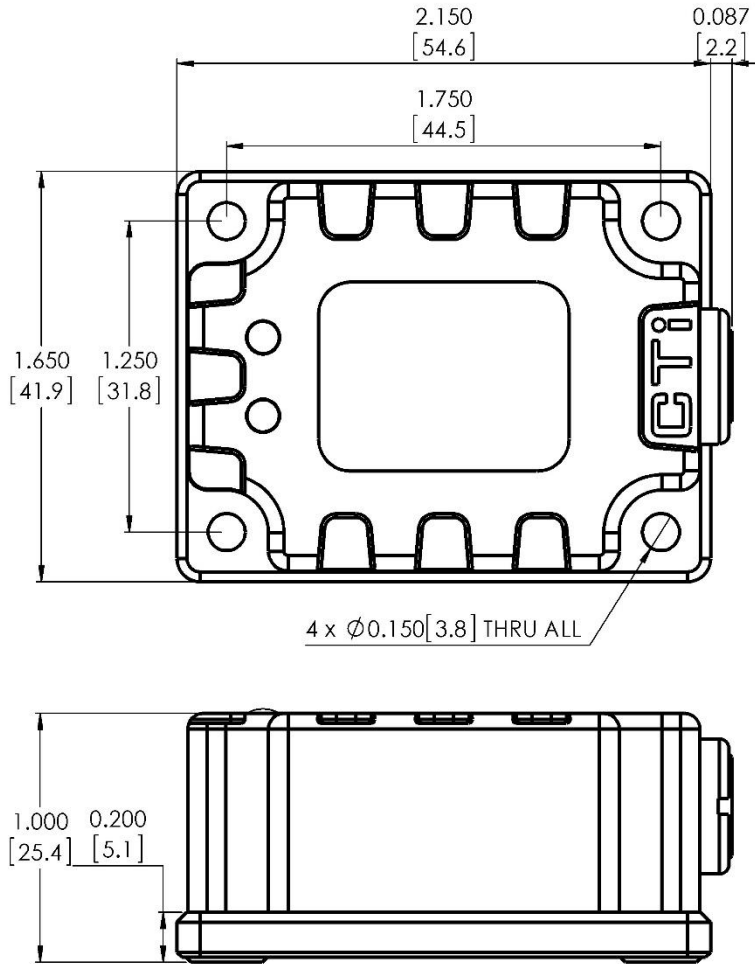

Inch
[millimeter]

10. Horizontal Installation Position

Measuring range: $\pm 90^\circ$ (two-dimensional)

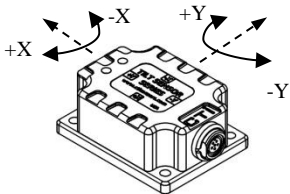

Default
Y=0

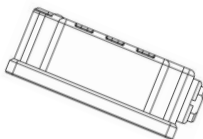

Inclination
Y=+30

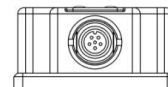

Default
X=0



Inclination
X=+30

11. Part Number

TILT – 57A – 3 – A1

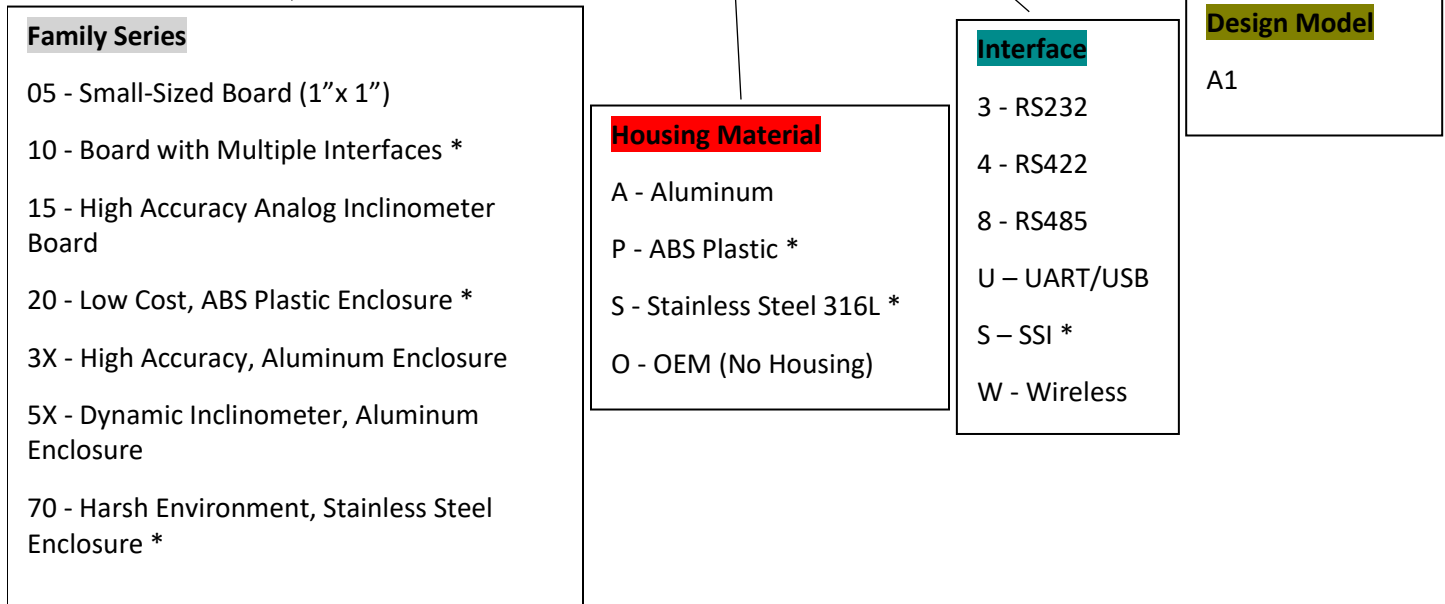

* Product/option not available

12. Wired Cables¹

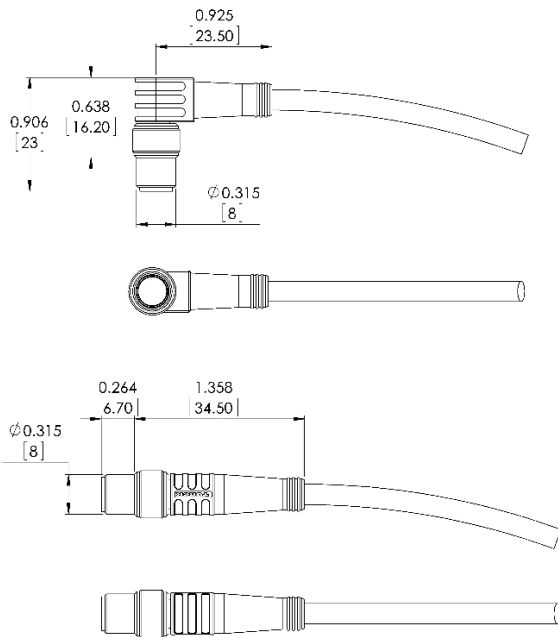
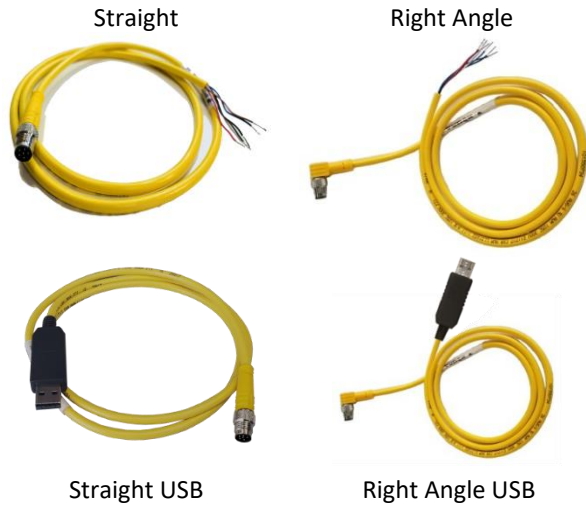

Inch

[millimeter]

Communication Cable Part Number²

XXX XX - X - X - CS

Interface

G UART / RS232 / RS422 / RS485

U USB

W Wireless³

Length

1 meter

2 meter

3 meter

4 meter (non-stock)

5 meter (non-stock)

6 meter (non-stock)

10 meter (Only PSG)

15 meter (non-stock)

30 meter (non-stock)

Type

PSG 6M Straight

PSW 6M Right Angle

Specifications

Protection	IP 67
Material	Connector: brass / nickel Cable molded head: TPU Cable carrier: TPU or nylon Conductor insulation: PVC
Operational Temperature range	-40°C to +85°C (-40°F to +185°F)
Connection	Cable gland Connector M8, 6-contact (male)

¹ Cable is a third-party product.

² Available options for this model are underlined.

³ Wireless module on device side has to be powered.

13. Revision History

Table 10. Revision History

Revision Number	Revision Date	Description of Changes
1.0	Oct. 2018	<ul style="list-style-type: none">Created document based on initial specifications
1.1	Dec. 2018	<ul style="list-style-type: none">Updated document to reflect new command structure
1.2	Feb. 2019	<ul style="list-style-type: none">Updated document to reflect new message structure
1.3	Apr. 2019	<ul style="list-style-type: none">Updated the GUI picture and some specifications
1.4	Aug. 2022	<ul style="list-style-type: none">Updated information and formatting

WARRANTY: This product has 18 months limited warranty. For more information, please visit: www.CTiSensors.com/warranty

This product is designed and manufactured in the U.S.A.

CTi Sensor, Inc.

30301 Emerald Valley Parkway, Unit B

Solon, OH 44139

Phone: (440) 264 - 2370

Email: Sales@CTiSensors.com

All contents of this document are subject to change without notice.