

# NTMFS08N004C

## MOSFET – Power Trench, N-Channel, Shielded Gate

**80 V, 126 A, 4.0 mΩ**

### General Description

This N-Channel MV MOSFET is produced using ON Semiconductor's advanced PowerTrench process that incorporates Shielded Gate technology. This process has been optimized to minimize on-state resistance and yet maintain superior switching performance with best in class soft body diode.

### Features

- Shielded Gate MOSFET Technology
- Max  $r_{DS(on)}$  = 4.0 mΩ at  $V_{GS} = 10\text{ V}$ ,  $I_D = 44\text{ A}$
- Max  $r_{DS(on)}$  = 12.5 mΩ at  $V_{GS} = 6\text{ V}$ ,  $I_D = 22\text{ A}$
- 50% Lower  $Q_{rr}$  than Other MOSFET Suppliers
- Lowers Switching Noise/EMI
- MSL1 Robust Package Design
- 100% UIL Tested
- These Devices are Pb-Free and are RoHS Compliant

### Applications

- Primary DC-DC MOSFET
- Synchronous Rectifier in DC-DC and AC-DC
- Motor Drive
- Solar

### MAXIMUM RATINGS ( $T_A = 25^\circ\text{C}$ unless otherwise noted)

Symbol	Parameter	Value	Unit
$V_{DS}$	Drain to Source Voltage	80	V
$V_{GS}$	Gate to Source Voltage	±20	V
$I_D$	Drain Current:		A
	Continuous, $T_C = 25^\circ\text{C}$ (Note 5)	126	
	Continuous, $T_C = 100^\circ\text{C}$ (Note 5)	80	
	Continuous, $T_A = 25^\circ\text{C}$ (Note 1a) Pulsed (Note 4)	18 637	
$E_{AS}$	Single Pulse Avalanche Energy (Note 3)	486	mJ
$P_D$	Power Dissipation:		W
	$T_C = 25^\circ\text{C}$	125	
	$T_A = 25^\circ\text{C}$ (Note 1a)	2.5	
$T_J, T_{STG}$	Operating and Storage Junction Temperature Range	-55 to +150	°C

Stresses exceeding those listed in the Maximum Ratings table may damage the device. If any of these limits are exceeded, device functionality should not be assumed, damage may occur and reliability may be affected.



ON Semiconductor®

[www.onsemi.com](http://www.onsemi.com)

$V_{DS}$	$R_{DS(ON)}$ MAX	$I_D$ MAX
80 V	4.0 mΩ @ 10 V	126 A
	12.5 mΩ @ 6 V	

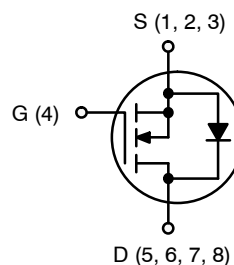

N-CHANNEL MOSFET

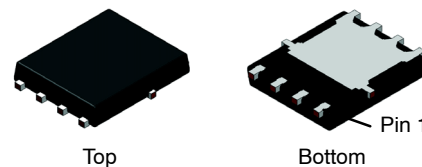

Power 56  
(PQFN8)  
CASE 483AE

### MARKING DIAGRAM

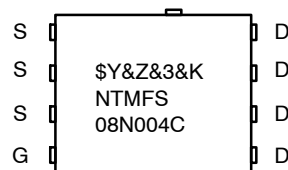

\$Y = ON Semiconductor Logo  
 &Z = Assembly Plant Code  
 &3 = Numeric Date Code  
 &K = Lot Code  
 NTMFS08N004C = Specific Device Code

### ORDERING INFORMATION

See detailed ordering and shipping information on page 3 of this data sheet.

# NTMFS08N004C

## THERMAL CHARACTERISTICS

Symbol	Parameter	Value	Unit
$R_{\theta JC}$	Thermal Resistance, Junction to Case	1.0	°C/W
$R_{\theta JA}$	Thermal Resistance, Junction to Ambient (Note 1a)	50	

## ELECTRICAL CHARACTERISTICS ( $T_J = 25^\circ\text{C}$ unless otherwise noted)

Symbol	Parameter	Test Condition	Min	Typ	Max	Unit
--------	-----------	----------------	-----	-----	-----	------

### OFF CHARACTERISTICS

$BV_{DSS}$	Drain to Source Breakdown Voltage	$I_D = 250 \mu\text{A}, V_{GS} = 0 \text{V}$	80			V
$\Delta BV_{DSS} / \Delta T_J$	Breakdown Voltage Temperature Coefficient	$I_D = 250 \mu\text{A}$ , referenced to $25^\circ\text{C}$		40		mV/°C
$I_{DSS}$	Zero Gate Voltage Drain Current	$V_{DS} = 64 \text{V}, V_{GS} = 0 \text{V}$			1	$\mu\text{A}$
$I_{GSS}$	Gate to Source Leakage Current	$V_{GS} = \pm 20 \text{V}, V_{DS} = 0 \text{V}$			$\pm 100$	nA

### ON CHARACTERISTICS

$V_{GS(th)}$	Gate to Source Threshold Voltage	$V_{GS} = V_{DS}, I_D = 250 \mu\text{A}$	2.0	3.1	4.0	V
$\Delta V_{GS(th)} / \Delta T_J$	Gate to Source Threshold Voltage Temperature Coefficient	$I_D = 250 \mu\text{A}$ , referenced to $25^\circ\text{C}$		-8.3		mV/°C
$r_{DS(on)}$	Static Drain to Source On Resistance	$V_{GS} = 10 \text{V}, I_D = 44 \text{A}$		3.4	4.0	m $\Omega$
		$V_{GS} = 6 \text{V}, I_D = 22 \text{A}$		5.2	12.5	
		$V_{GS} = 10 \text{V}, I_D = 44 \text{A}, T_J = 125^\circ\text{C}$		5.8	7.8	
$g_{FS}$	Forward Transconductance	$V_{DS} = 5 \text{V}, I_D = 44 \text{A}$		98		S

### DYNAMIC CHARACTERISTICS

$C_{iss}$	Input Capacitance	$V_{DS} = 40 \text{V}, V_{GS} = 0 \text{V}, f = 1 \text{MHz}$		3035	5100	pF
$C_{oss}$	Output Capacitance			940	1580	pF
$C_{rss}$	Reverse Transfer Capacitance			27	50	pF
$R_g$	Gate Resistance		0.1	1.1	2.3	$\Omega$

### SWITCHING CHARACTERISTICS

$t_{d(on)}$	Turn-On Delay Time	$V_{DD} = 40 \text{V}, I_D = 44 \text{A}, V_{GS} = 10 \text{V}, R_{GEN} = 6 \Omega$		17	30	ns
$t_r$	Rise Time			6	12	ns
$t_{d(off)}$	Turn-Off Delay Time			25	40	ns
$t_f$	Fall Time			4	10	ns
$Q_g$	Total Gate Charge	$V_{GS} = 0 \text{V to } 10 \text{V}, V_{DD} = 40 \text{V}, I_D = 44 \text{A}$		39	66	nC
		$V_{GS} = 0 \text{V to } 6 \text{V}, V_{DD} = 40 \text{V}, I_D = 44 \text{A}$		25	41	nC
$Q_{gs}$	Gate to Source Charge	$V_{DD} = 40 \text{V}, I_D = 44 \text{A}$		13		nC
$Q_{gd}$	Gate to Drain "Miller" Charge	$V_{DD} = 40 \text{V}, I_D = 44 \text{A}$		7		nC
$Q_{oss}$	Output Charge	$V_{DD} = 40 \text{V}, V_{GS} = 0 \text{V}$		55		nC
$Q_{sync}$	Total Gate Charge Sync.	$V_{DS} = 0 \text{V}, I_D = 44 \text{A}$		35		nC

# NTMFS08N004C

## ELECTRICAL CHARACTERISTICS ( $T_J = 25^\circ\text{C}$ unless otherwise noted) (continued)

Symbol	Parameter	Test Condition	Min	Typ	Max	Unit
<b>DRAIN-SOURCE DIODE CHARACTERISTICS</b>						
$V_{SD}$	Source to Drain Diode Forward Voltage	$V_{GS} = 0\text{ V}, I_S = 2.1\text{ A}$ (Note 2)		0.7	1.2	V
		$V_{GS} = 0\text{ V}, I_S = 44\text{ A}$ (Note 2)		0.8	1.3	
$t_{rr}$	Reverse Recovery Time	$I_F = 22\text{ A}, di/dt = 300\text{ A}/\mu\text{s}$		26	41	ns
$Q_{rr}$	Reverse Recovery Charge			48	76	nC
$t_{rr}$	Reverse Recovery Time	$I_F = 22\text{ A}, di/dt = 1000\text{ A}/\mu\text{s}$		19	31	ns
$Q_{rr}$	Reverse Recovery Charge			108	174	nC

Product parametric performance is indicated in the Electrical Characteristics for the listed test conditions, unless otherwise noted. Product performance may not be indicated by the Electrical Characteristics if operated under different conditions.

### NOTES:

- $R_{\theta JA}$  is determined with the device mounted on a 1 in<sup>2</sup> pad 2 oz copper pad on a 1.5 × 1.5 in. board of FR-4 material.  $R_{\theta CA}$  is determined by the user's board design.

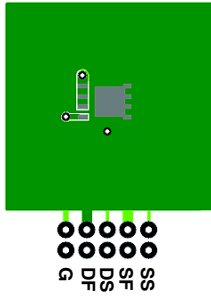

a) 50°C/W when mounted on a 1 in<sup>2</sup> pad of 2 oz copper.

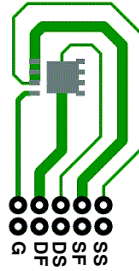

b) 125°C/W when mounted on a minimum pad of 2 oz copper.

- Pulse Test: Pulse Width < 300  $\mu\text{s}$ , Duty cycle < 2.0%.
- $E_{AS}$  of 486 mJ is based on starting  $T_J = 25^\circ\text{C}$ ; N-ch:  $L = 3\text{ mH}, I_{AS} = 18\text{ A}, V_{DD} = 80\text{ V}, V_{GS} = 10\text{ V}$ . 100% test at  $L = 0.1\text{ mH}, I_{AS} = 57\text{ A}$ .
- Pulsed  $I_d$  please refer to Figure 11 SOA graph for more details.
- Computed continuous current limited to Max Junction Temperature only, actual continuous current will be limited by thermal & electro-mechanical application board design.

## PACKAGE MARKING AND ORDERING INFORMATION

Device	Marking	Package	Reel Size	Tape Width	Quantity
NTMFS08N004C	NTMFS08N004C	Power 56 (PQFN8) (Pb-Free / Halogen Free)	13"	12 mm	3000 units

# NTMFS08N004C

## TYPICAL CHARACTERISTICS

( $T_J = 25^\circ\text{C}$  unless otherwise noted)

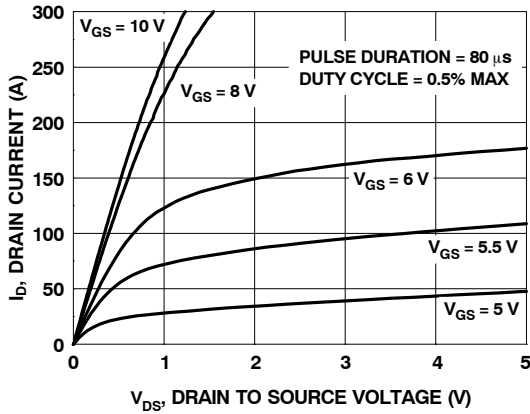

Figure 1. On Region Characteristics

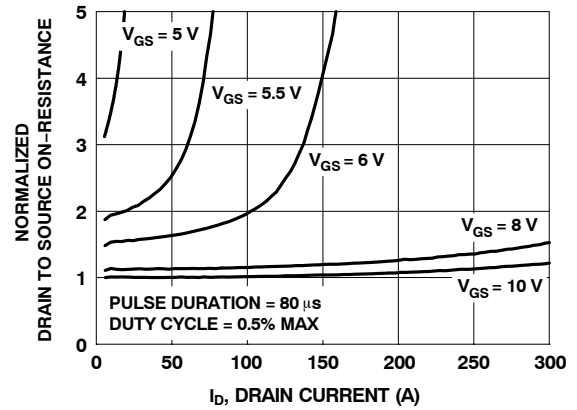

Figure 2. Normalized On-Resistance vs. Drain Current and Gate Voltage

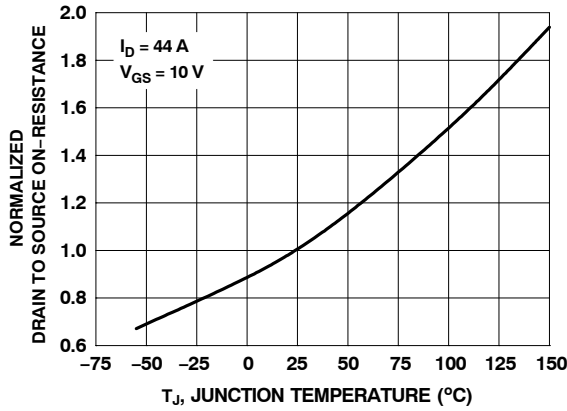

Figure 3. Normalized On-Resistance vs. Junction Temperature

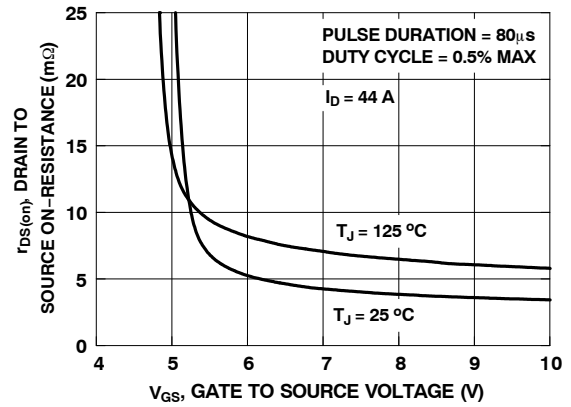

Figure 4. On-Resistance vs. Gate to Source Voltage

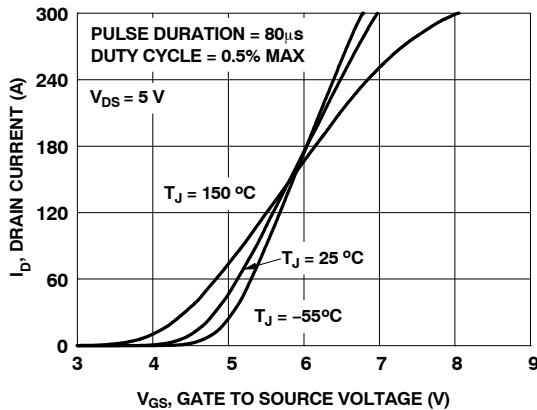

Figure 5. Transfer Characteristics

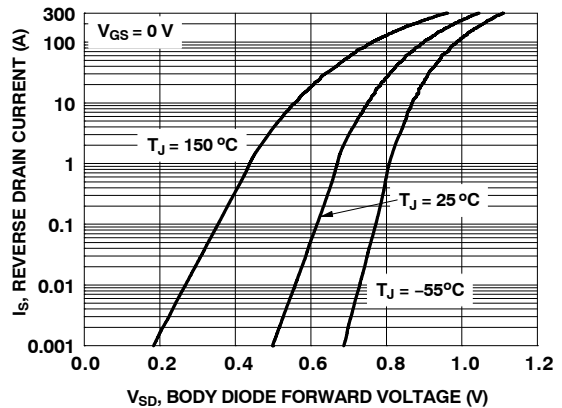

Figure 6. Source to Drain Diode Forward Voltage vs. Source Current

# NTMFS08N004C

## TYPICAL CHARACTERISTICS

( $T_J = 25^\circ\text{C}$  unless otherwise noted)

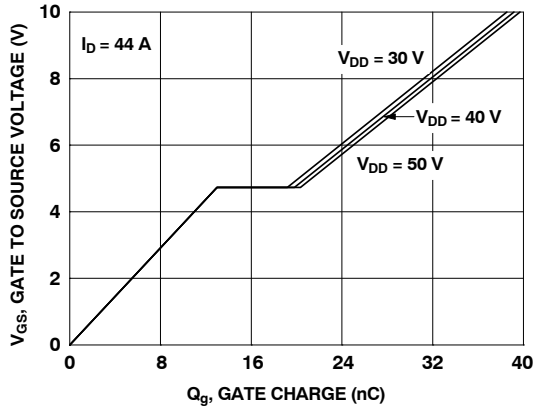

Figure 7. Gate Charge Characteristics

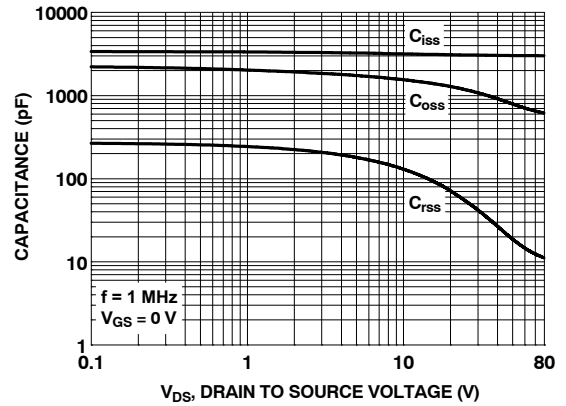

Figure 8. Capacitance vs. Drain to Source Voltage

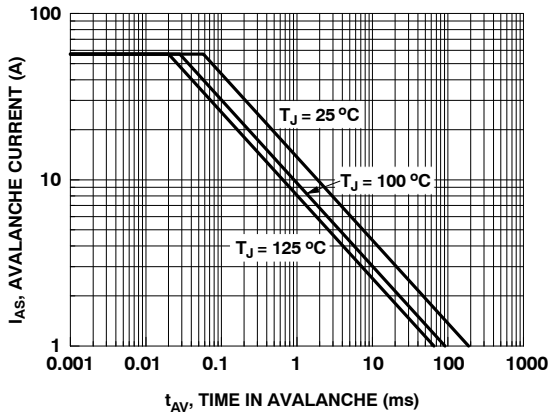

Figure 9. Unclamped Inductive Switching Capability

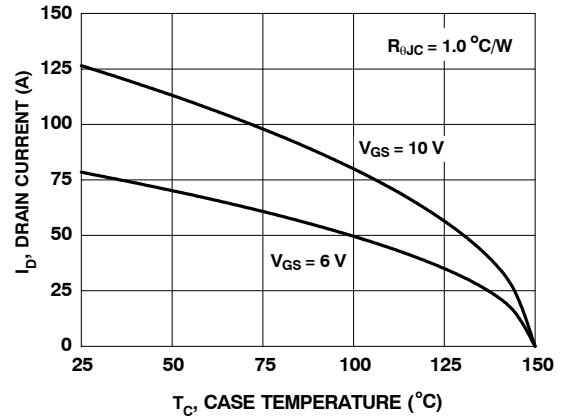

Figure 10. Maximum Continuous Drain Current vs. Case Temperature

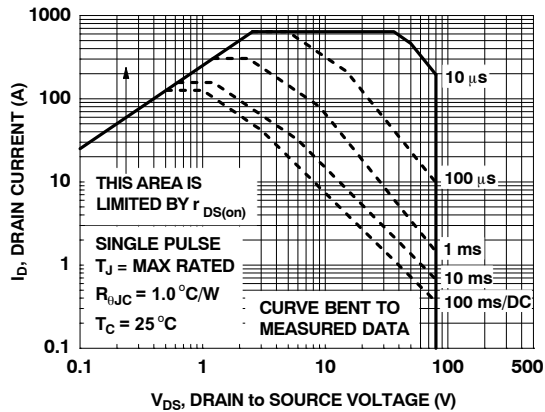

Figure 11. Forward Bias Safe Operating Area

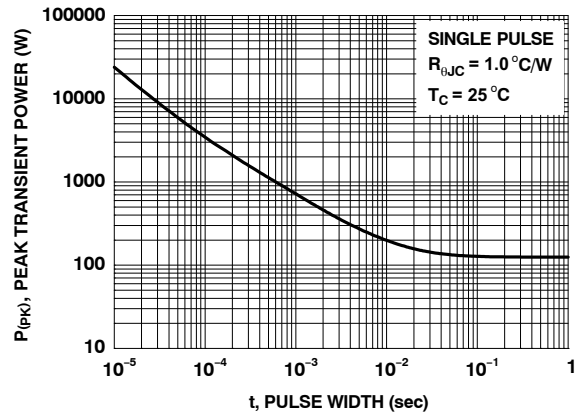

Figure 12. Single Pulse Maximum Power Dissipation

# NTMFS08N004C

## TYPICAL CHARACTERISTICS

( $T_J = 25^\circ\text{C}$  unless otherwise noted)

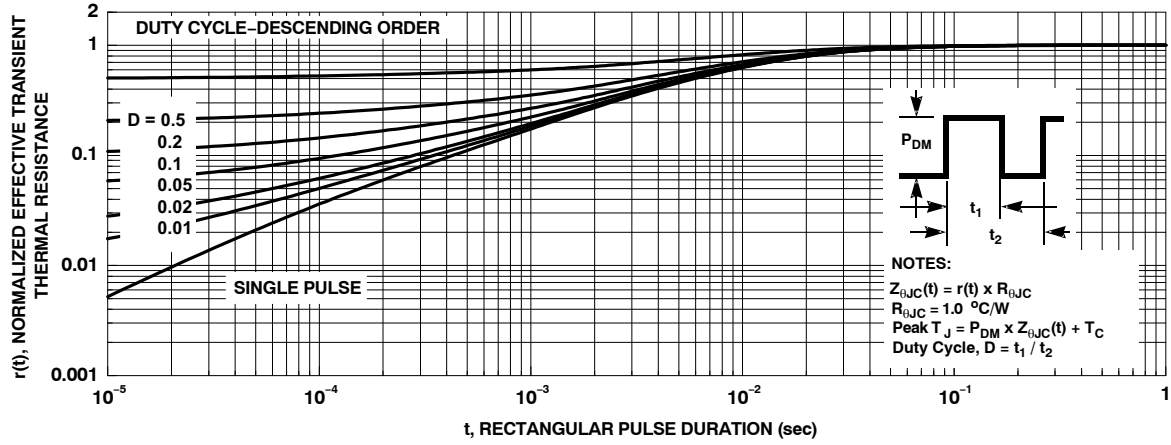
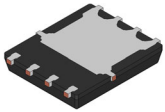

Figure 13. Junction-to-Case Transient Thermal Response Curve

# MECHANICAL CASE OUTLINE PACKAGE DIMENSIONS



**PQFN8 5X6, 1.27P**  
CASE 483AE  
ISSUE C

DATE 21 JAN 2022

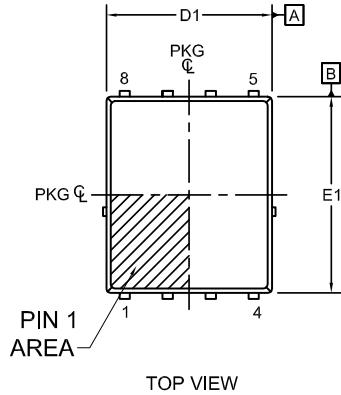

**NOTES:**

1. DIMENSIONING AND TOLERANCING PER ASME Y14.5M, 2009.
2. CONTROLLING DIMENSION: MILLIMETERS
3. COPLANARITY APPLIES TO THE EXPOSED PADS AS WELL AS THE TERMINALS.
4. DIMENSIONS D1 AND E1 DO NOT INCLUDE MOLD FLASH, PROTRUSIONS, OR GATE BURRS.
5. SEATING PLANE IS DEFINED BY THE TERMINALS. "A1" IS DEFINED AS THE DISTANCE FROM THE SEATING PLANE TO THE LOWEST POINT ON THE PACKAGE BODY.
6. IT IS RECOMMENDED TO HAVE NO TRACES OR VIAS WITHIN THE KEEP OUT AREA.

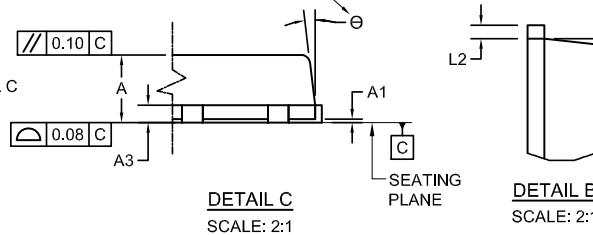
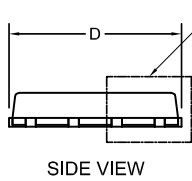

DIM	MILLIMETERS		
	MIN.	NOM.	MAX.
A	0.90	1.00	1.10
A1	0.00	-	0.05
b	0.21	0.31	0.41
b1	0.31	0.41	0.51
A3	0.15	0.25	0.35
D	4.90	5.00	5.20
D1	4.80	4.90	5.00
D2	3.61	3.82	3.96
E	5.90	6.15	6.25
E1	5.70	5.80	5.90
E2	3.38	3.48	3.78
E3	0.30 REF		
E4	0.52 REF		
e	1.27 BSC		
e/2	0.635 BSC		
e1	3.81 BSC		
e2	0.50 REF		
L	0.51	0.66	0.76
L2	0.05	0.18	0.30
L4	0.34	0.44	0.54
z	0.34 REF		
θ	0°	-	12°

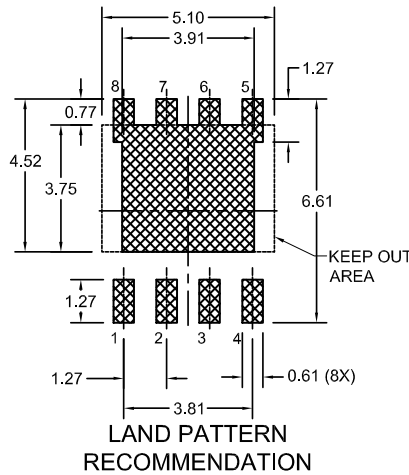
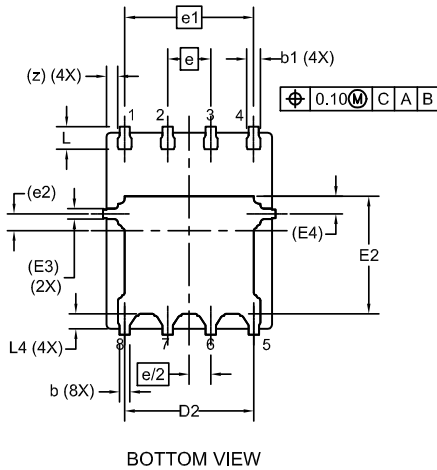

\*FOR ADDITIONAL INFORMATION ON OUR PB-FREE STRATEGY AND SOLDERING DETAILS, PLEASE DOWNLOAD THE ON SEMICONDUCTOR SOLDERING AND MOUNTING TECHNIQUES REFERENCE MANUAL, SOLDERRM/D.

<b>DOCUMENT NUMBER:</b>	<b>98AON13655G</b>	Electronic versions are uncontrolled except when accessed directly from the Document Repository. Printed versions are uncontrolled except when stamped "CONTROLLED COPY" in red.
<b>DESCRIPTION:</b>	<b>PQFN8 5X6, 1.27P</b>	<b>PAGE 1 OF 1</b>

onsemi and ONSEMI are trademarks of Semiconductor Components Industries, LLC dba onsemi or its subsidiaries in the United States and/or other countries. onsemi reserves the right to make changes without further notice to any products herein. onsemi makes no warranty, representation or guarantee regarding the suitability of its products for any particular purpose, nor does onsemi assume any liability arising out of the application or use of any product or circuit, and specifically disclaims any and all liability, including without limitation special, consequential or incidental damages. onsemi does not convey any license under its patent rights nor the rights of others.

**onsemi**, **Onsemi**, and other names, marks, and brands are registered and/or common law trademarks of Semiconductor Components Industries, LLC dba "**onsemi**" or its affiliates and/or subsidiaries in the United States and/or other countries. **onsemi** owns the rights to a number of patents, trademarks, copyrights, trade secrets, and other intellectual property. A listing of **onsemi**'s product/patent coverage may be accessed at [www.onsemi.com/site/pdf/Patent-Marking.pdf](http://www.onsemi.com/site/pdf/Patent-Marking.pdf). **onsemi** reserves the right to make changes at any time to any products or information herein, without notice. The information herein is provided "as-is" and **onsemi** makes no warranty, representation or guarantee regarding the accuracy of the information, product features, availability, functionality, or suitability of its products for any particular purpose, nor does **onsemi** assume any liability arising out of the application or use of any product or circuit, and specifically disclaims any and all liability, including without limitation special, consequential or incidental damages. Buyer is responsible for its products and applications using **onsemi** products, including compliance with all laws, regulations and safety requirements or standards, regardless of any support or applications information provided by **onsemi**. "Typical" parameters which may be provided in **onsemi** data sheets and/or specifications can and do vary in different applications and actual performance may vary over time. All operating parameters, including "Typicals" must be validated for each customer application by customer's technical experts. **onsemi** does not convey any license under any of its intellectual property rights nor the rights of others. **onsemi** products are not designed, intended, or authorized for use as a critical component in life support systems or any FDA Class 3 medical devices or medical devices with a same or similar classification in a foreign jurisdiction or any devices intended for implantation in the human body. Should Buyer purchase or use **onsemi** products for any such unintended or unauthorized application, Buyer shall indemnify and hold **onsemi** and its officers, employees, subsidiaries, affiliates, and distributors harmless against all claims, costs, damages, and expenses, and reasonable attorney fees arising out of, directly or indirectly, any claim of personal injury or death associated with such unintended or unauthorized use, even if such claim alleges that **onsemi** was negligent regarding the design or manufacture of the part. **onsemi** is an Equal Opportunity/Affirmative Action Employer. This literature is subject to all applicable copyright laws and is not for resale in any manner.

## ADDITIONAL INFORMATION

### TECHNICAL PUBLICATIONS:

Technical Library: [www.onsemi.com/design/resources/technical-documentation](http://www.onsemi.com/design/resources/technical-documentation)  
onsemi Website: [www.onsemi.com](http://www.onsemi.com)

### ONLINE SUPPORT: [www.onsemi.com/support](http://www.onsemi.com/support)

For additional information, please contact your local Sales Representative at [www.onsemi.com/support/sales](http://www.onsemi.com/support/sales)

