

## LAURA-O

~40° x 12° oval beam optimized for CREE XP-E.  
Assembly with black holder and installation  
tape.

### TECHNICAL SPECIFICATIONS:

Dimensions	21.6 mm
Height	13.1 mm
Fastening	tape
Colour	black
Box size	
Box weight	7.6 kg
Quantity in Box	1440 pcs
ROHS compliant	yes ⓘ



### MATERIAL SPECIFICATIONS:

Component	Type	Material	Colour
LAURA-O	Single lens	PMMA	clear
LAURA-HLD-XP-BLK	Holder	PC	black
ROSE-TAPE	Tape	PU tape	

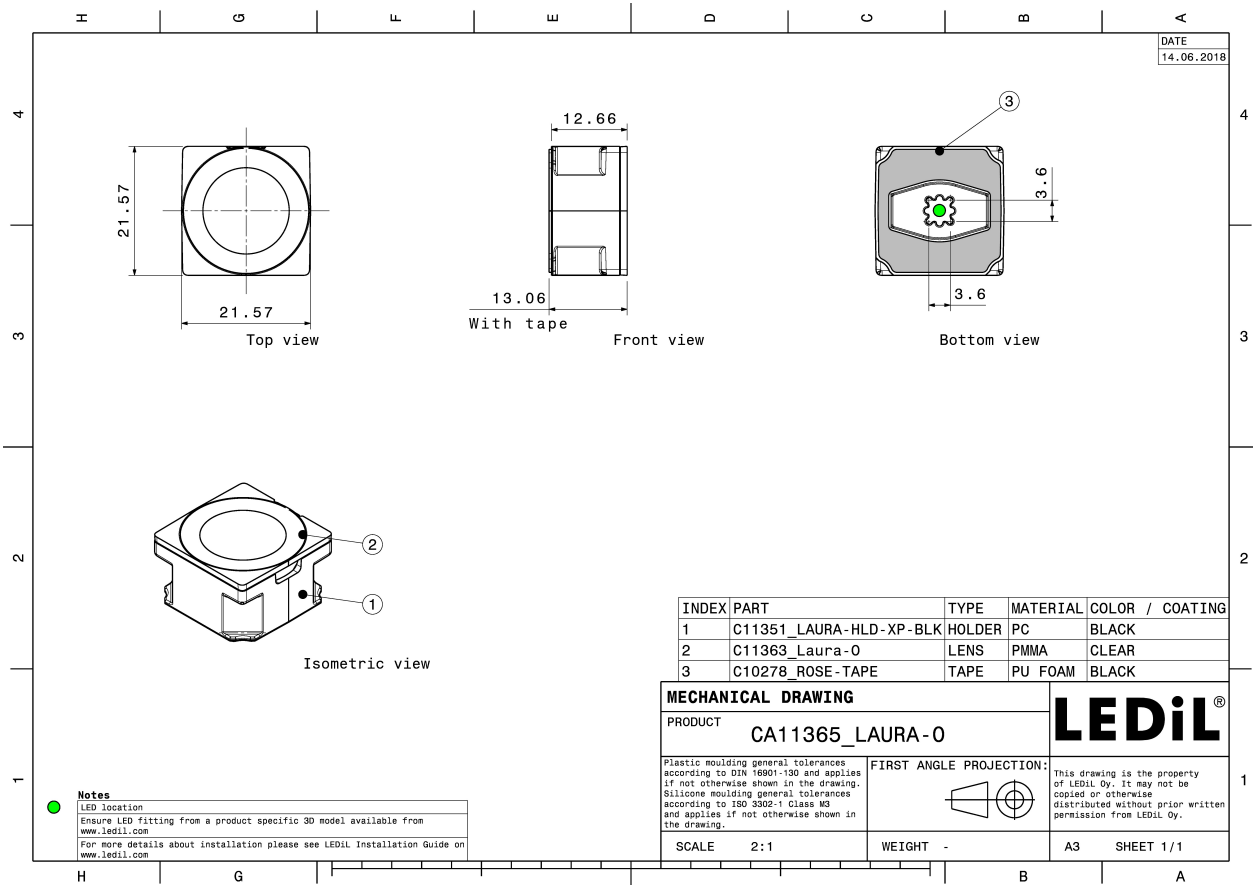

#### PHOTOMETRIC DATA (MEASURED):

#### CREE

LED XP-E  
FWHM 13.0 + 40.0°  
Efficiency 91 %  
Peak intensity 4.100 cd/lm  
LEDs/each optic 1  
Light colour White  
Required components:

#### CREE

LED XP-E2  
FWHM 40.0 + 12.0°  
Efficiency 87 %  
Peak intensity 5.700 cd/lm  
LEDs/each optic 1  
Light colour White  
Required components:

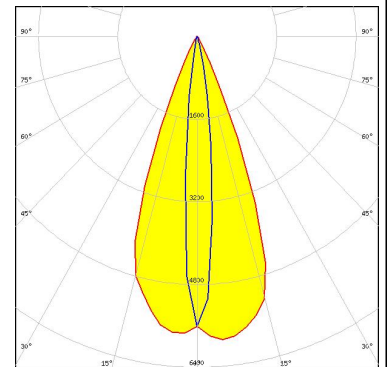

#### CREE

LED XP-G  
FWHM 36.0 + 13.0°  
Efficiency 91 %  
Peak intensity 4.100 cd/lm  
LEDs/each optic 1  
Light colour White  
Required components:

#### CREE

LED XP-G2  
FWHM 39.0 + 14.0°  
Efficiency 87 %  
Peak intensity 4.900 cd/lm  
LEDs/each optic 1  
Light colour White  
Required components:

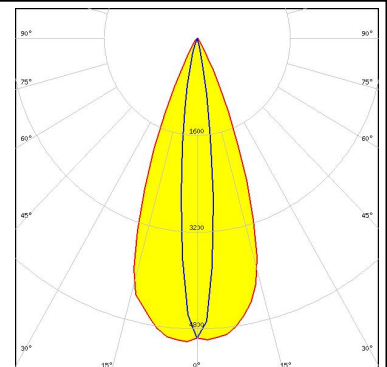
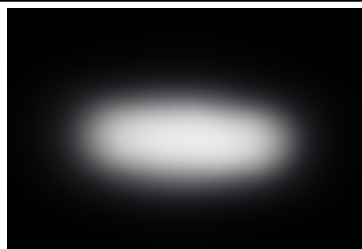

## PHOTOMETRIC DATA (MEASURED):

 **LG Innotek**

LED H35C1 (LEMWA33)  
FWHM 39.0 + 14.0°  
Efficiency 86 %  
Peak intensity 4.600 cd/m  
LEDs/each optic 1  
Light colour White  
Required components:

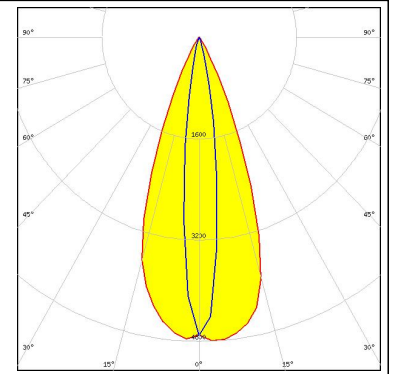
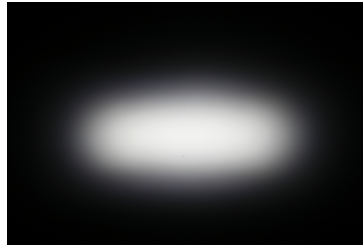

### PHOTOMETRIC DATA (SIMULATED):



LED XD16  
FWHM 64.0 + 10.0°  
Efficiency 79 %  
Peak intensity 2.820 cd/lm  
LEDs/each optic 1  
Light colour White  
Required components:

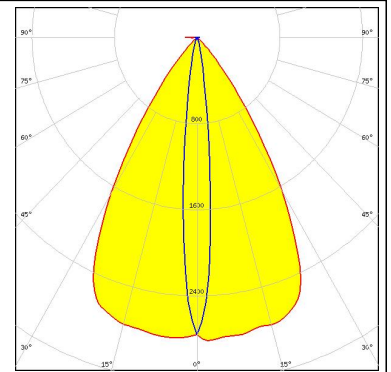

SEOUL SEMICONDUCTOR

LED Z5  
FWHM 12.0 + 36.0°  
Efficiency %  
Peak intensity cd/lm  
LEDs/each optic 1  
Light colour White  
Required components:

### GENERAL INFORMATION:

NOTE: The typical beam angle will be changed by different color, chip size and chip position tolerance. The typical total beam angle is the full angle measured where the luminous intensity is half of the peak value.

### MATERIALS:

As part of our continuous research and improvement processes, and to ensure the best possible quality and availability of our products, LEDiL reserves the right to change material grades without notice.

### PRODUCT DATA USER AGREEMENT AND DISCLAIMER:

The measured data in the provided downloadable LEDiL Product Datasheets and Mechanical 2D-Drawings is rounded and provided as reference for planning. LEDiL Oy's optical specifications have been verified by conducting performance testing of the products in accordance with the company's quality system. The reported data are averaged results of multiple measurements with typical variation. LEDiL Oy reserves the right to without prior notification make changes and improvements to its products.

LEDiL Oy assumes neither warranty, nor guarantee nor any other liability of any kind for the contents and correctness of the provided data. The provided data has been generated with highest diligence but the provided data may in reality not represent the complete possible variation range of all intrinsic parameters. Therefore, in certain cases a deviation from the provided data could occur.

LEDiL Oy reserves the right to undertake technical changes of its products without further notification which could lead to changes in the provided data. LEDiL Oy assumes no liability of any kind for the possible deviation from any provided data or any other damage resulting from the usage of the provided data.

The user agrees to this disclaimer and user agreement with the download or usage of the provided files.

#### LEDiL Oy

Joensuunkatu 13  
FI-24240 SALO  
Finland

#### LEDiL Inc.

228 West Page Street  
Suite D  
Sycamore IL 60178  
USA

#### Local sales and technical support

[www.ledil.com/  
where\\_to\\_buy](http://www.ledil.com/where_to_buy)

#### Shipping locations

Salo, Finland  
Hong Kong, China

#### Distribution Partners

[www.ledil.com/  
where\\_to\\_buy](http://www.ledil.com/where_to_buy)