



PC, DVI, DISPORT PORT, HDMI, VIDEO INTERFACE CONTROLLER FOR TFT PANEL

Model: SVX-2560

Part number : 4174700XX-3 or up

INSTRUCTIONS

CONTENTS

Page:	2. Introduction, How to Proceed, Usage Note, Disclaimer
	3. System design – Diagram of a suggested system
	4. Assembly notes – Important information about system elements
	7. Connection & Operation – How to use the controller
	14. Connectors, pinouts & jumpers – Essential connection information
	28. Controller dimensions
	29. Application notes
	31. Troubleshooting
	32. Specifications
	33. Appendix I – Supported graphics modes table
	37. Appendix II – RS-232 control protocols
	49. Appendix III – Mapping definition
	53. Appendix IV – Auto Color Gain
	54. Appendix V – DV remote control unit work for SVX-2560
	55. Appendix VI – PIP mix table
	56. Appendix VII - Network connection
	57. Appendix VIII – Audio Support
	60. Warranty, Caution & Limitation of Liability, Trademarks
	61. Contact details
	62. Revision history

It is essential that these instructions are read and understood before connecting or powering up this controller.

Introduction

Designed for LCD monitor and other flat panel display applications, the SVX-2560 is a feature rich interface controller for :

- TFT (active matrix) LCD panels of 2560x1600, 2560x1440, 1920x1920, 1920x1200, 1920x1080(120Hz), 1920x1080, 1920x480, 1680x1050, 1600x1200, 1600x900, 1440x900, 1366x768, 1280x1024, 1280x800, 1280x768 1024x768, 1024x600, 800x600, 800x480 and 640x480 resolutions.
- Computer video signals of VGA, SVGA, XGA, SXGA, WXGA, UXGA, WUXGA standard.
- Support true 10 bits panel
- Support HDMI, DVI, VGA, Display Port & Component Video input

Ordering information :

Controller	Part number	Ordering part number
SVX-2560	P/N 41747003X-3	P/N 4174700XX-3

HOW TO PROCEED

- Ensure you have all parts & that they are correct, refer to:
 - Connection diagram

Controller Solution Generator

Full web resource matching controllers & panels with **connection diagrams** for download.
See at : <http://www.digitalview.com/csg>

- Connector reference (in following section)
- Assembly notes
- Check controller switch & jumper settings (errors may damage the panel)
- Prepare the PC
- Connect the parts
- Understand the operation & functions

IMPORTANT USAGE NOTE

This equipment is for use by developers and integrators, the manufacturer accepts no liability for damage or injury caused by the use of this product. It is the responsibility of the developer, integrators or other user of this product to:

- Ensure that all necessary and appropriate safety measures are taken.
- Obtain suitable regulatory approvals as may be required.
- **Check power settings to all component parts before connection.**

DISCLAIMER

There is no implied or expressed warranty regarding this material.

SYSTEM DESIGN

A typical LCD based display system utilizing this controller is likely to comprise the following:

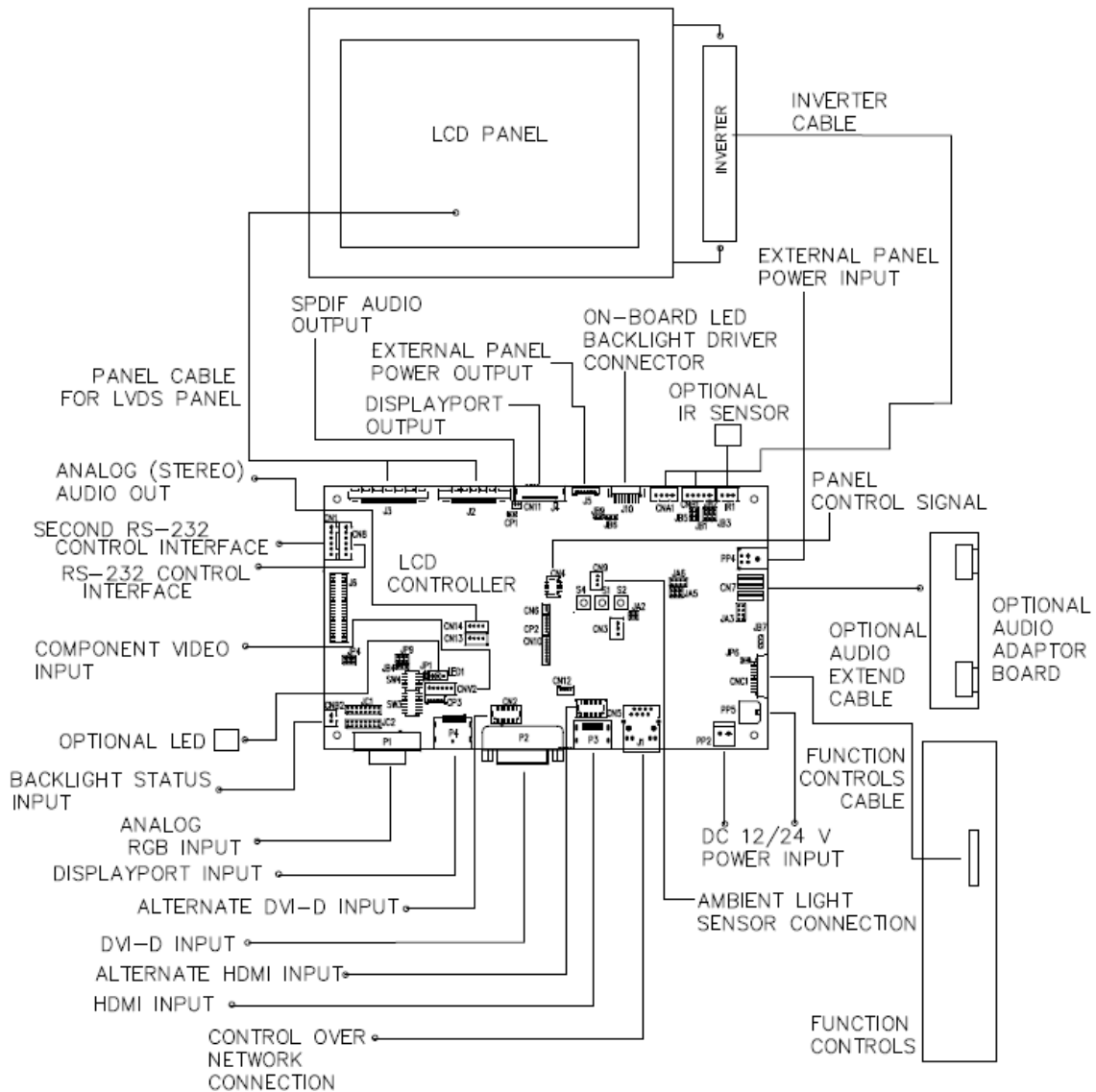

ASSEMBLY NOTES

This controller is designed for monitor and custom display projects using 2560x1600 or 2560x1440 or 1920x1920 or 1920x1200 or 1920x1080(120Hz) or 1920x1080 or 1920x480 or 1680x1050 or 1600x1200 or 1600x900 or 1440x900 or 1366x768 or 1280x1024 or 1280x800 or 1280x768 or 1024x768 or 1024x600 or 800x600 or 800x480 or 640x480 resolution TFT panels with a VGA, SVGA, WXGA, XGA, SXGA, UXGA or WUXGA signal input. The following provides some guidelines for installation and preparation of a finished display solution.

Preparation: Before proceeding it is important to familiarize yourself with the parts making up the system and the various connectors, mounting holes and general layout of the controller. As much as possible connectors have been labeled. Guides to connectors and mounting holes are shown in the following relevant sections.

- LCD Panel:** This controller is designed for typical LVDS interfaced panels with panel voltage 3.3V, 5V, 12V or 18V, External for 12V~18V interface. Due to the variation between manufacturers of panels signal timing and other panel characteristics, factory setup and confirmation should be obtained before connecting to a panel. **(NOTE: Check panel power jumper settings before connection)**
- Controller:** Handle the controller with care as static charge may damage electronic components. Make sure correct jumper and dip switches settings to match the target LCD panel.
- LCD signal cable (LVDS panel):** In order to provide a clean signal it is recommended that LVDS signal cables are no longer than 46cm (18 inches). If those wire cabling is utilized these can be made into a harness with cable ties. Care should be taken when placing the cables to avoid signal interference. Additionally it may be necessary in some systems to add ferrite cores to the cable to minimize signal noise.
- Inverter:** This will be required for the backlight of an LCD, some LCD panels have an inverter built in. As LCD panels may have 1 or more backlight tubes and the power requirements for different panel backlights may vary it is important to match the inverter in order to obtain optimum performance. See Application notes page 24 for more information on connection.
- Inverter Cables:** Different inverter models require different cables and different pin assignment. Make sure correct cable pin out to match inverter. Using wrong cable pin out may damage the inverter.
- Function Controls:** The following section discusses the controls required and the section on connectors provides the detail. The controls are minimal: On/Off, Backlight Brightness (depends on inverter), OSD (5 momentary buttons) analog VR type or (8 momentary buttons) digital type.
The 8 momentary buttons OSD switch mount P/N 416100520-3 or OSD membrane interface P/N 416100120-3 must be used when 24VDC input.
- Function controls cable:** The cables to the function switches should be of suitable quality and length so that impedance does not affect performance. Generally lengths up to 1 meter (3 feet) should be acceptable.
- Status LED:** The pin direction of the LED should be corrected for right color indication. Red color stands for standby. Green colors stands for signal on. The status LED is an optional part only, can be unconnected.
- IR sensor:** It is an optional part only, can be unconnected if not using IR remote control. See Appendix V in details.
- RS-232 control interface :** Firmware upgrade and serial control via this interface port.
- Second RS-232 control interface :** This interface support controlled under "Programming mode".
Press and hold "MENU" button on the OSD switch mount and turn on the controller to enter the "Programming mode".
Choose "Set Uart 1 to CN1" Input Port shown below :

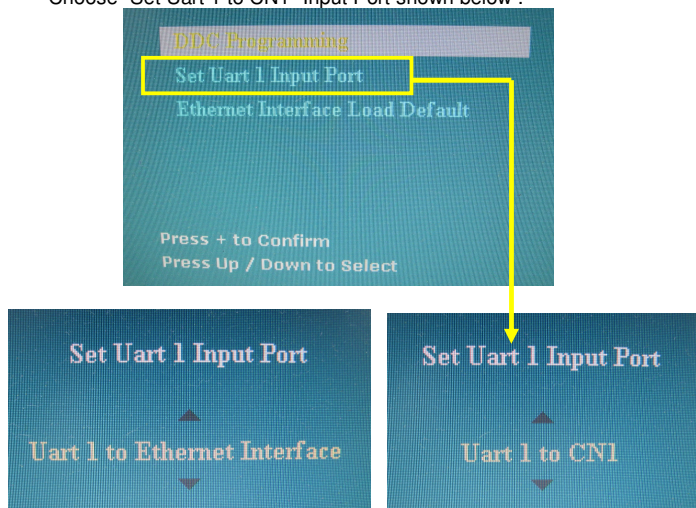

Set "Uart 1 to Ethernet Interface : Enable Ethernet network (J1) support and disable second RS-232 serial control (CN1) support

Set "Uart 1 to CN1 : Enable second RS-232 serial control (CN1) support. Disable Ethernet network (J1) support

12. **External panel power output** : User for specific panel model.
 13. **Panel control signal** : Use for specific panel model.
 14. **SPDIF Audio output** : This port support SPDIF audio output from the HDMI / Displayport audio source inputted. The audio output follows with the input source selected (HDMI / Displayport).
 15. **Ambient light sensor connection** : 3 ways connector provides interface for ambient light sensor connection by using Kit 70220-3.
 16. **Backlight status input** : 2 ways connector provides interface for connection with the specific panel type which support the panel with backlight status monitoring function.
 17. **On board LED backlight driver** : The on board LED driver supports 4 LED strings max 50V total LED backlight via J10 connector.
 18. **Display Port output** : Use for specific display port interface panel.
 19. **HD / SD Component video input** : Plug the component video input cable P/N 426000600-3 on CNV2 connector
 20. **DVI-D input** : Plug the DVI cable to the connector P3 on the controller board.
 21. **HDMI input** : Support HDMI 1.4 standard. Plug the HDMI cable to the connector P2 on the controller board. This port is not supported when CN5 is connected.
 22. **Analog RGB Input** : As this may affect regulatory emission test results and the quality of the signal to the controller a suitably shielded cable should be utilized.
 23. **Display Port input** : Support single-link Display Port 1.2. Plug the Display Port cable to the connector P4 on the controller board. .
 24. **Alternate HDMI input** : This port gives alternate HDMI input support. This port is not support when P3 connector is connected.
 25. **Alternate DVI-D input** : This port gives alternate DVI-D input support. This port is not supported when P2 connector is connected.
 26. **Control over network connection** : This is a network device that allow to control RS-232 enable devices over a TCP/IP based Ethernet and the Internet using a web browser. Please refer to Appendix VII in details.
 27. **Audio add-on board P/N 416940020-3**: The audio add-on board gives the audio input and output signal connection. It is an optional part only, can be unconnected if not using audio.
CAUTION : The Audio Add-on Board P/N 416940020-3 can only operate with 12VDC power input environment.
 28. **Audio extend cable** : The audio extend cable P/N 426009700-3 designs for connection between audio add on board P/N 416940020-3 and the controller. It is an optional part only, can be unconnected if not using audio.
 29. **Power Input**: 12V/24VDC is required, this should be a regulated supply. The power rating is depending on the panel and inverter used. Normally, power supply with 3.5Amp current output should enough for most of 4x CCFT panels. Although the controller provides power regulation for the LCD power this does not relate to the power supplied to the backlight inverter. If an unregulated power supply is provided to an inverter any fluctuations in power may affect operation, performance and lifetime of the inverter and or backlight tubes.
 30. **External panel power input** : Allow to supply external power to the panel separately for max 3.3V (7A) or 5V (7A) or 12V (5A) or 18V (3.5A) via PP4 power input connector. Corresponding jumper setting of JA3, JA5 & JA6 are required for each panel power input by referring to page 14.
- **Power output**: Note the controller has an overall 3Amp current limit and the current available from the auxiliary power output will be dependent on the power input and other system requirements.
 - **Power Safety**: Note that although only 12V / 24VDC is required as 'power-in' a backlight inverter for panel backlighting produces significantly higher voltages (the inverter does not connect to the ground plane). We strongly advise appropriate insulation for all circuitry.
 - **EMI**: Shielding will be required for passing certain regulatory emissions tests. Also the choice of external Controller to PC signal cable can affect the result.
 - **Ground**: The various PCB mounting holes are connected to the ground plane.
 - **Servicing**: The board is not user serviceable or repairable. Warranty does not cover user error in connecting up to the controller and is invalidated by unauthorized modification or repairs.

Specifications subject to change without notice

- **Controller Mounting:** It is recommended that a clearance of at least 10mm is provided above and 5mm below the controller when mounted. Additionally consideration should be given to:
 - Electrical insulation.
 - Grounding.
 - EMI shielding.
 - Cable management. Note: It is important to keep panel signal cables apart from the inverter & backlight cables to prevent signal interference.
 - Heat & Ventilation: Heat generated from other sources, for example the backlight of a very high brightness panel may generate significant heat which could adversely affect the controller.
 - Other issues that may affect safety or performance.

- **PC Graphics Output:** A few guidelines:
 - Signal quality is very important, if there is noise or instability in the PC graphics output this may result in visible noise on the display.
 - Refer to graphics modes table in specifications section for supported modes.
 - Non-interlaced & interlaced video input is acceptable.

IMPORTANT: Please read the Application Notes section for more information.

CONNECTION & OPERATION

CAUTION: Never connect or disconnect parts of the display system when the system is powered up as this may cause serious damage.

CONNECTION

Connection and usage is quite straight forward (it is useful to have the relevant connection diagram available at this time):

1. **LCD panel & Inverter:** Connect the inverter (if it is not built-in the panel) to the CCFT lead connector of the LCD panel.
2. **LVDS type panels:** The controller board has the built-in LVDS transmitter driver. Plug the LVDS cable to J3. Insert the panel end of the cable the LCD panel connector.
3. **Inverter & Controller:** Plug the inverter cable to CNB1 and CNA1 (if necessary). Plug another end to the connector on the inverter.
4. **Function switch & Controller:** Plug the OSD switch mount cable to CNC1 on the controller board and another to the OSD switch mount.
5. **LED & Controller:** Plug in a 3-way with dual color LED to connector LED1 on the controller board.
6. **IR & Controller:** Plug in a 3-way with IR sensor to connector IR1 on the controller board.
7. **Jumpers & Switches:** Check all jumpers and switches (SW3, SW4) are set correctly. Details referring the connection diagram (a separate document) or the jumpers and switches setting table (in the following section).
8. **Jumpers & Inverter & Panel voltage:** Particularly pay attention to the settings of JA3, JA5, JA6, JB2 and JB3. JB2 & JB3 are used for inverter control (read inverter specification and information on the jumper table to define the correct settings). JA3 & JA5 & JA6 is used for panel voltage input (read panel specification and information on the jumper table to define the correct settings).
9. **Input signal cable & Controller:** Plug the corresponding signal input to the connector on the controller board.
10. **Power supply & Controller:** Plug the DC 12V/24V power in to the connector PP5 or PP2. You can consider to use DigitalView mating power cable P/N 426013800-3, 160mm for PP5 connection.
11. **External panel power input :** Plug power cable : P/N 426013700-3 for external panel power input (3.3 (max 7A) / 5V (max 7A) / 12V (max 5A) / 18V (max3.5))
12. **Power on:** Switch on the controller board and panel by using the OSD switch mount.

General:

- If you are using supplied cables & accessories, ensure they are correct for the model of panel and controller.
- If you are making your own cables & connectors refer carefully to both the panel & inverter specifications and the section in this manual, "Connectors, Pinouts & Jumpers" to ensure the correct pin to pin wiring.

PC SETTINGS

The controller has been designed to take a very wide range of input signals however to optimize the PC's graphics performance we recommend choosing 60Hz vertical refresh rate – this will not cause screen flicker.

OPERATION

Once the system has been connected and switched on there are a number of functions available to adjust the display image as summarized in the following sections. The settings chosen will be saved for each mode independently.

LCD DISPLAY SYSTEM SETTINGS

NOTE: By way of explanation the following refers to a set of sample buttons that may be obtained as an option. In addition to power on/off and connection for backlight brightness the controller provides an On Screen Display of certain functions which are controlled by 5 momentary type buttons (analog VR type) or 8 momentary type buttons (digital type):

Controls	Analog VR type	Digital type
On/Off – turns controller board power on	VR toggle switch	On/Off button
Brightness – controls backlight brightness	Rotary VR	Brightness +/- buttons
Menu – Turns OSD menu On or Off (it will auto time off) – Back to previous OSD menu page	Menu button	Menu button
Select down – Moves the selector to the next function (down)	SEL DN	SEL DN
Select up – Moves the selector to the previous function (up)	SEL UP	SEL UP
+ – Increase the OSD parameter values – Go into the sub-menu page from the top – Confirm to select the OSD function	+	+
- – Decrease the OSD parameter values – Go into the sub-menu page from the bottom	-	-
Reset to Factory Defaults	Press and hold SEL DN button, then power on the controller	Press and hold SEL DN button, then power on the controller
Access "Programming Mode"	Press and hold MENU button, then power on the controller	Press and hold MENU button, then power on the controller

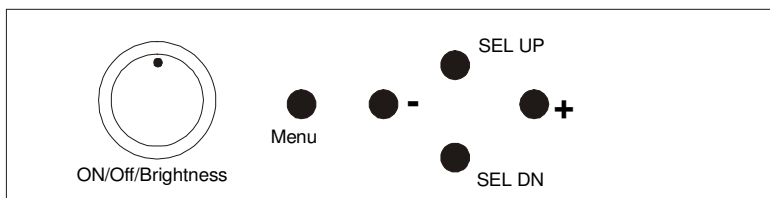

Analog VR type

12V / 24VDC power input :
Analog 10K VR Type OSD switch mount uses P/N 410680550-3 or up

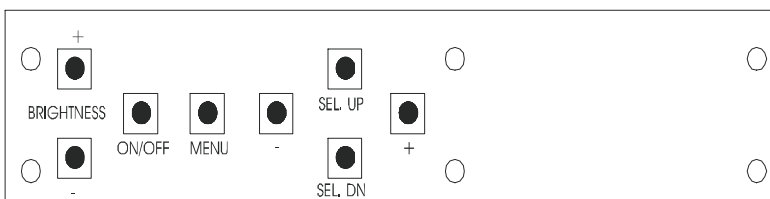







Digital type

12V / 24VDC power input :
Digital 10K Type OSD switch mount uses P/N 416100520-3 or up

OSD functions



Picture :

- Brightness  Increase/decrease panel brightness level, total: 100 steps
- Contrast  Increase/decrease panel contrast level, total: 100 steps
- Saturation  Increase/decrease saturation, total: 100 steps
- Hue **  Increase/decrease Hue level, total: 100 steps
- Sharpness*  Increase/decrease sharpness, total: 30 steps
- Backlight  Backlight brightness adjustment (Functions when light detector sets OFF)

Position##



Move the image position upward



Move the image position downward



Move the image position to the left



Move the image position to the right

Aspect / Size ▶

- Fill Screen : Enable full screen expansion for lower resolution Image
- Fill to Aspect Ratio: Enable fill screen expansion for lower resolution image according to aspect ratio
- 4 : 3 : scaling format in 4:3
- 16 : 9 : scaling format in 16:9
- 16 : 10 : scaling format in 16:10
- 2.35 : 1 : scaling format in 2.35:1
- 2 : 1 : scaling format in 2:1
- 1 : 1 : Display the exact image resolution on the screen without image expansion.

* : DISPLAY IN VIDEO MODE ONLY

** : FUNCTION IN ARGB/ DVI / VIDEO NTSC MODE ONLY

: FUNCTION IN ARGB MODE ONLY



Source : Select the input video signal

- Main Port Change ▾
- VGA
- DVI
- HDMI
- Display Port
- Component 1

PIP Port change ▾

PIP Off / VGA/ DVI / HDMI / Display Port / Component 1

PIP Size ▾ : Off / PIP Size 1~18 / Size by Size / Size by Size Tall

The PIP capability on display input sources refer to Appendix VII – PIP mix table

PIP Position :



Move the PIP position upward



Move the PIP position downward



Move the PIP position to the left



Move the PIP position to the right

PIP Blend Level : 6.25% ~ 100% : PIP Transparency

PIP Swap : Swap between the main window and PIP window

PIP Auto Turn off : OFF ON : OFF / ON

ON : When PIP is no signal input after 30 seconds, the PIP window will turn off automatically.

OFF : PIP window keeps on

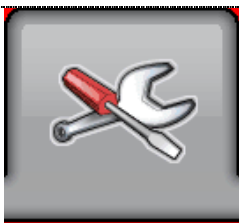

Utilities :

Setup ▾

Auto Picture Setup# : Auto adjust the image position, phase and size

Auto Color Gain+ ▾ : Auto Color Calibration (See appendix IV)

- Return
- Execute

Wide Screen Mode Selection# ▾ : Recognize the wide screen mode coming from ARGB port

- Group 1
 - 1024x768
 - 1280x768
 - 1360x768
 - 1366x768
- Group 2
 - 1440x900
 - 1600x900

Manual Clock# : Adjust the image horizontal size

Manual Phase# : Fine tune the data sampling position (adjust image quality)

Auto Source Seek :

- Auto : OFF ON : OFF / ON

ON – Auto source select always enable

OFF – Disable auto source select function

- Setup ▾ Selection for the corresponding input sources detection

VGA OFF ON

DVI OFF ON

HDMI OFF ON

Display Port OFF ON

Component 1 OFF ON

The corresponding input port name display on OSD menu will disappear once setting "OFF".

Auto Power : OFF ON OFF / ON

ON – Enable soft power off function if absence of input signals
OFF – Disable soft power function

Anti Image Retention :

Anti Image Retention : 

Method : Flash / Pixel Shift / Horizontal Pan / Vertical Pan

Flash : Flashing the screen

Pixel Shift : Image shift pixel by pixel around the screen

Horizontal Pan : Display a pattern moving horizontally on screen.

Vertical Pan : Display a pattern moving horizontally on screen.

Horizontal Pan Setting :

Height > Panel Height : ±2 / ±4 / ±6 / ±8 : Configure the pattern height

Width > Panel Width : ±2 / ±4 / ±6 / ±8 : Configure the pattern width

Pattern : Black / White : Configure the pattern color

Pass : 1 ~ 100 : Configure the pattern moving cycle

Vertical Pan Setting :

Height > Panel Height : ±2 / ±4 / ±6 / ±8 : Configure the pattern height

Width > Panel Width : ±2 / ±4 / ±6 / ±8 : Configure the pattern width

Pattern : Black / White : Configure the pattern color

Pass : 1 ~ 100 : Configure the pattern moving cycle

Flash Setting :

Timer : 1 ~ 100s : Configure the flashing duration

Flash Period : 1 ~ 100 : Configure the flashing cycle

Note : Anti Image retention state will be cleared once you press the MENU button.

Gamma : 0.6 / 0.7 / 0.8 / 0.9 / 1.0 / 1.1 / 1.2 / 1.3 / 1.4 / 1.5 / 1.6 / 1.7 / 1.8 / 1.9 / 2.0 / 2.1 / 2.2 / 2.3 / 2.4 / 2.5 / 2.6 (Effective on V1.22.00.00 or later firmware revision)

Image Orientation** ▶

Normal

Horizontal Flip

Vertical Flip

Rotate

OSD ▶

OSD position :



Move the OSD menu image position upward



Move the OSD menu position downward



Move the OSD menu position to the left



Move the OSD menu position to the right

OSD Timeout (sec) : ON – 60 : Adjust the OSD menu timeout period in a step of 5 seconds (max 60 seconds)

ON = Continuous to display OSD menu.

60 = 60 seconds later will turn off the OSD menu.

Language : English / Spanish / French / German / Chinese : Select OSD menu language display

Display Input :  OFF / ON : Display input source info after switching source.

IR Remote control : IR Remote Enable : Set enable on IR remote control

IR Remote Disable : Set disable on IR remote control

Real time clock* ▶ show and edit the real time clock

DATE : DD/MM/YYYY : Date/Month/Year

TIME : HH/MM/SS (AM/PM): Hour/Minute/Second

SETUP ▶

Month / Day / Year

Hour / Minute / AM/PM

Display Clock  : Disable or enable to display the real time clock when display video source info after switching source.

Freeze : Freeze the image (use “+” button)

Audio Output ▶ (Effective on V1.22.00.00 or later firmware revision and input signal connected to HDMI connector (P3/CN5) or Display Port connector (P4))

Audio Output : Analog Audio / SPDIF

- Analog Audio : select the analog audio output from CN14 connector.

- SPDIF : select the digital audio output from CN11 (SPDIF) connector.

Audio Input Source : Digital Audio / Line In

- Digital Audio : select the audio input source from HDMI / HD-3000S (via alternate HDMI connector)
- Line In : select the audio input source connected to the Line in connector on the external audio add on board.

(Please refer to appendix VIII in details of usage)

Zoom ▶

Zoom level :  : Enable the zoom in function on the image displayed.
Use "+" button to zoom in the image
Use "-" button to decrease the zoomed image

Horizontal pan :  : Pan the image horizontally

Vertical pan :  : Pan the image vertically

Factory Reset

Note : Freeze state will be cleared when you using zoom function.

Color Temperature ▶

5000K

Red Gain : 

Green Gain : 

Blue Gain : 

Red Offset : 

Green Offset : 

Blue Offset : 

Reset to Defaults : Resume to the default values

6500K

Red Gain : 

Green Gain : 

Blue Gain : 

Red Offset : 

Green Offset : 

Blue Offset : 

Reset to Defaults : Resume to the default values

8000K

Red Gain : 

Green Gain : 

Blue Gain : 

Red Offset : 

Green Offset : 

Blue Offset : 

Reset to Defaults : Resume to the default values

9300K

Red Gain : 

Green Gain : 

Blue Gain : 

Red Offset : 

Green Offset : 

Blue Offset : 

Reset to Defaults : Resume to the default values

User setting :

Red Gain : 

Green Gain : 

Blue Gain : 

Red Offset : 

Green Offset : 

Blue Offset : 

Reset to Defaults : Resume to the default values

Reset All to Defaults : Resume all color temperature settings to the default values.

Hot Key ▶



Hot key 1 : Brightness / Contrast / Inputs / Aspect Ratio/ Zoom / Freeze / PIP Size / PIP Swap / PIP ON/OFF / Saturation / Hue / Backlight / Auto Picture Setup / No Function

Hot key 2 : Brightness / Contrast / Inputs / Aspect Ratio/ Zoom / Freeze / PIP Size / PIP Swap / PIP ON/OFF / Saturation / Hue / Backlight / Auto Picture Setup / No Function

Monochrome Mode ▶ (Effective on V1.22.00.00 or later firmware revision)

- Color
- Red Monochrome
- Green Monochrome
- Blue Monochrome
- Red Only (Display when JP4 position 5-6 is closed)
- Green Only (Display when JP4 position 5-6 is closed)
- Blue Only (Display when JP4 position 5-6 is closed)

Backlight Setup ▶

- B/L Invert :  : Invert for the backlight brightness
- B/L Control : D/A / PWM : Selection for voltage level dimming control / PWM dimming control
- Backlight Frequency :  100 ~ 440Hz in a step of 20
- Light Detector :  : Enable ambient light detector function by using KIT 70220-3
- Min Backlight Level : 0 ~ 50% : Default the minimum backlight adjustment.

Default Setting ▶

Reset to Factory Defaults ▶ (Activate when JC1 position 4 sets open)

Are you sure ? Yes/No

Reset to Factory Defaults with (Color Temp.) ▶ (Activate when JC1 position 4 sets open)

Are you sure ? Yes/No

Save Current Settings as Calibrated Values ▶ (Activate when JC1 position 2 sets closed)

Are you sure ? Yes/No

Recall Stored Calibrated Values ▶

Are you sure ? Yes/No

* : NOT DISPLAY AFTER P/N 417470022-3 or later version

: DISPLAY IN ARGB MODE ONLY

+ DISPLAY IN ARGB & COMPONENT MODE ONLY

** The image orientation function is not support under the following conditions :

- PIP
- Component 1 (via CNV2 connector) input.
- Driving with 1366x768 panel
- Zoom

Firmware V1.22.00.00 or up

CONNECTORS, PINOUTS & JUMPERS

The various connectors are:

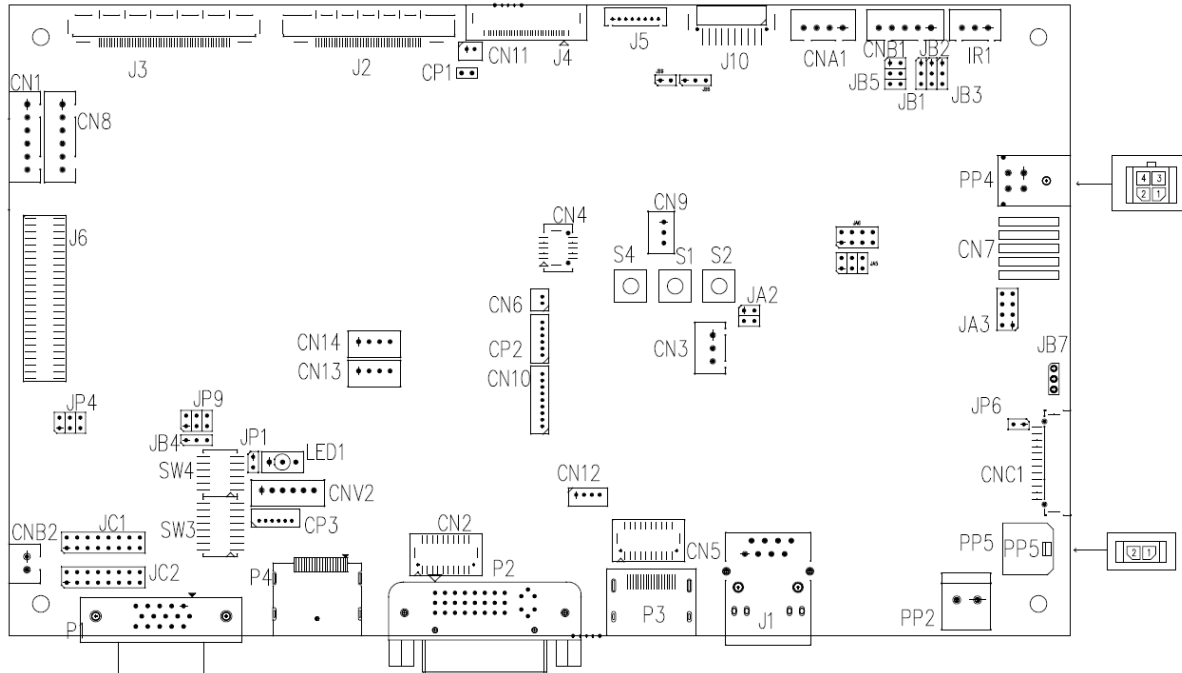

Summary: Connectors

Ref	Purpose	Description
CN1	Second RS-232 serial control	JST 6-way, B6B-XH-A (Matching type : XHP-6)
CN2	On board internal connector for DVI	JST BM20B-SRDS (Matching type : SHDR-20V-S-B) (Matching extend cable P/N 426302900-3)
CN3	Reserved for external temperature sensor	JST 3-way, B3B-XH-A or compatible (Matching type : XHP-3)
CN4	Panel control signal connector	Hirose 10-pin, DF20G-10DP-1V (Matching type : DF20A-10DS-1C)
CN5	On board internal connector for HDMI	JST BM29B-SRDS (Matching type : SHDR-20V-S-B) (Matching extend cable P/N 426301800-3)
CN6	Reserved for light sensor	DF13 2 ways (Mating type : DF13-2S-1.25C)
CN7	Reserved for Audio line out	2x5 right angled header (Matching audio add-on board P/N 416940020-3 & Audio extend cable P/N 426009700-3)
CN8	RS-232 serial control	JST 6-way, B6B-XH-A or compatible (Matching type : XHP-6)
CN9	Ambient light sensor connector	JST 3-way, B3B-PH-K or compatible (Matching type : PHR-3)
CN10	Reserved for Fan & backlight power monitoring connector	Hirose DF13-9P-1.25 DSA (Mating type : DF13-9S-1.25C)
CN11	SPDIF Audio output	JST B2B-ZR (Matching type : ZHR-2) (Matching extend cable P/N 426007400-3)
CN12	Reserved for engineering use	Reserved
CN13	Reserved for Speaker in	JST B4B-ZR (Matching type : ZHR-4)
CN14	Analog (Stereo) audio out	JST B4B-ZR (Matching type : ZHR-4)
CNA1	Auxiliary power output	JST 4-way, B4B-XH-A or compatible (Matching type : XHP-4) (Matching cable P/N 426040200-3)
CNB1	Backlight inverter	JST 5-way, B5B-XH-A or compatible (Matching type : XHP-5) (Matching cable P/N 426058300-3)
CNB2	Backlight status input connector	JST 2 way, B2B-XH-A or compatible (Matching type : XHP-2)
CNC1	OSD control	Hirose DF13A-12P-1.25H (Mating type : DF13-12S-1.25C) (Matching OSD switch mount cable P/N 426122200-3 (150mm) or 426122210-3 (250mm))
CNV2	Component (YPbPr) video input connector	JST 6-way, B6B-PH-K (Matching type : PHR-6)
CP1	Reserved for internal programming	Reserved
CP2	Reserved for internal programming	Reserved
CP3	Reserved for internal programming	Reserved
IR1	Infra-red sensor connector	JST 3-way, B3B-XH-A or compatible (Matching type : XHP-3)
J1	Ethernet (IP-60)	RJ-45 connector
J2	LVDS panel signal output 1	JAE FI-RE41S-HF (Matching type : FI-RE41HL)
J3	LVDS panel signal output 2	JAE FI-RE51S-HF (Matching type : FI-RE51HL)

Specifications subject to change without notice

© Digital View Ltd – Doc Ver 3.02: 26 Aug, 2016

Page 14 of 63

J4	Display port output for panel connection	I-PEX 20455-030E-12 (Matching type : I-PEX 20454-030T)
J5	Panel power output for Disport port interface panel use.	Molex 53261-0871 (Matching type : Molex 51021-0800)
J6	Reserved for Digital interface for SDI / Video mux board (AVD-1000) connector. (This connector function is not implemented yet)	DIL Header 25x2, 1.27x2.54 SMT
J10	On board LED backlight driver connector	Molex 53261-1000 (Matching type : Molex 51021-1000)
P1	VGA	DB-15 way high density 3 row
P2	DVI-D	DVI-D connector
P3	HDMI	HDMI connector
P4	Displayport	Display port connector
PP2	Power input (alternative)	DC power Molex 2 pin 0.156" pitch
PP4	External panel power input	Molex 43045-0400 compatible (Matching connector type : Molex 43025-0400 compatible) (Matching power cable : P/N 426013700-3)
PP5	Power input	Molex 43650-0200 compatible (Matching connector type : Molex 43645-0200 compatible) (Matching power cable : P/N 426013800-3)
SW3	Panel selection	8-way DIP Switch
SW4	Function selection	6-way DIP Switch

Summary: Jumpers setting

Ref	Purpose	Note
JA2	On board +3.3V logic power enable	1-2 & 3-4 closed, factory set, do not remove
JA3	Panel power voltage select CAUTION: Incorrect setting can damage panel	See panel voltage setting table 1
JA5	Panel power voltage select CAUTION: Incorrect setting will cause panel damage	See panel voltage setting table 1
JA6	Panel power voltage select CAUTION: Incorrect setting will cause panel damage	See panel voltage setting table 1
JB1	Backlight brightness voltage range	1-2 closed = 5V max 2-3 closed = 3.3V max
JB2	Backlight inverter on/off control – signal level	2-3 = On/Off control signal 'High' = +5V 1-2 = On/Off control signal 'High' = +3.3V Open = On/Off control signal 'High' = Open collector CAUTION: Incorrect setting can damage inverter.
JB3	Backlight inverter on/off control – polarity	1-2 = control signal 'high' = CCFT ON 2-3 = control signal 'low' = CCFT ON
JB4	GPIO pins voltage selection	1-2 = 3.3V 2-3 = 5V
JB5	Backlight control type selection	1-2 = VR/Digital switch mount control 3-4 = Analog backlight brightness - voltage range 0~5V 5-6 = PWM (Pulse Width Modulation) brightness
JB6	Maximum LED backlight current selection	1-2 = 150mA 3-4 = 120mA
JB7	Backlight control voltage on CNB1 pin 4 (Function when JB5 sets 1-2 closed)	Open = For OSD switch mount control (Default) 1-2 = 0V 2-3 = 3.3V / 5V controlled by JB1
JB9	On board LED backlight driver function	Open = Disable Closed = Enable
JC1	Custom configuration	Default Open
JC2	Custom configuration	Position 1 : Enable J3 – pin 16 (OP1) controlled by JB4 Position 2 : Enable J3 – pin 17 (OP2) controlled by JB4 Position 3 : Enable J3 – pin 18 (OP3) controlled by JB4 Position 4 : Enable J3 – pin 19 (OP4) controlled by JB4
JP4	Custom configuration	1-2 closed = Reserved 3-4 closed = On-board programming 5-6 closed = Display "Blue only" function on OSD menu
JP6	Input power control	Short = External switch control Open = Switch mount control
JP9	Factory use	Default Open
S1	Reset button (IP-60)	Tact switch button
S2	Reserved	Tact switch button
S4	Config menu function	Tact switch button
SW3	Panel & function selection	See table 2
SW4	Panel & function selection	See table 3

Table 1 : Panel voltage setting table :







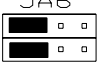

Input voltage via PP2 / PP5	Panel Voltage	JA3	JA5	JA6	Jumper on board
12VDC	3.3V	3V3 closed	1-3 & 2-4	1-3 & 2-4	
	5V	5V closed	1-3 & 2-4	1-3 & 2-4	
	12V	OPEN	1-3 & 2-4	5-7 & 6-8	

CAUTION: Incorrect setting can damage panel & controller

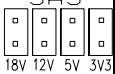
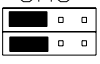
Input voltage via PP2 / PP5	Panel Voltage	JA3	JA5	JA6	Jumper on board
24VDC**	3.3V	3V3 closed	1-3 & 2-4	1-3 & 2-4	
	5V	5V closed	1-3 & 2-4	1-3 & 2-4	
	12V	12V closed	1-3 & 2-4	3-5 & 4-6	
	18V	18V closed	1-3 & 2-4	3-5 & 4-6	

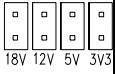
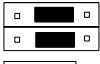
CAUTION: Incorrect setting can damage panel & controller

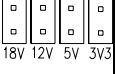
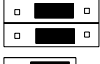
**** Ensure that the backlight inverter supports 24V operation prior to connecting a 24VDC input. Because CNA1 pin 1 and CNB1 pin 2 will output 24VDC if input 24VDC via PP2/PP3 or PP5.**

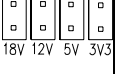
Input voltage via PP4	Input voltage via PP2 / PP5	Panel Voltage	JA3	JA5	JA6	Jumper on board
3.3 / 5 / 12 / 18VDC*	12V / 24VDC	3.3V	OPEN	3-5 & 4-6	1-3 & 2-4	  
		5V	OPEN	3-5 & 4-6	1-3 & 2-4	  
		12V	OPEN	3-5 & 4-6	3-5 & 4-6	  
		18V	OPEN	3-5 & 4-6	3-5 & 4-6	  

* Maximum current for 3.3V, 5V = 7A, Maximum current for 12V = 5A, Maximum current for 18V = 3.5A

JA3, JA5 & JA6 location on board : (Please pay attention to the jumper settings on JA3, JA5 & JA6 which are red in color)

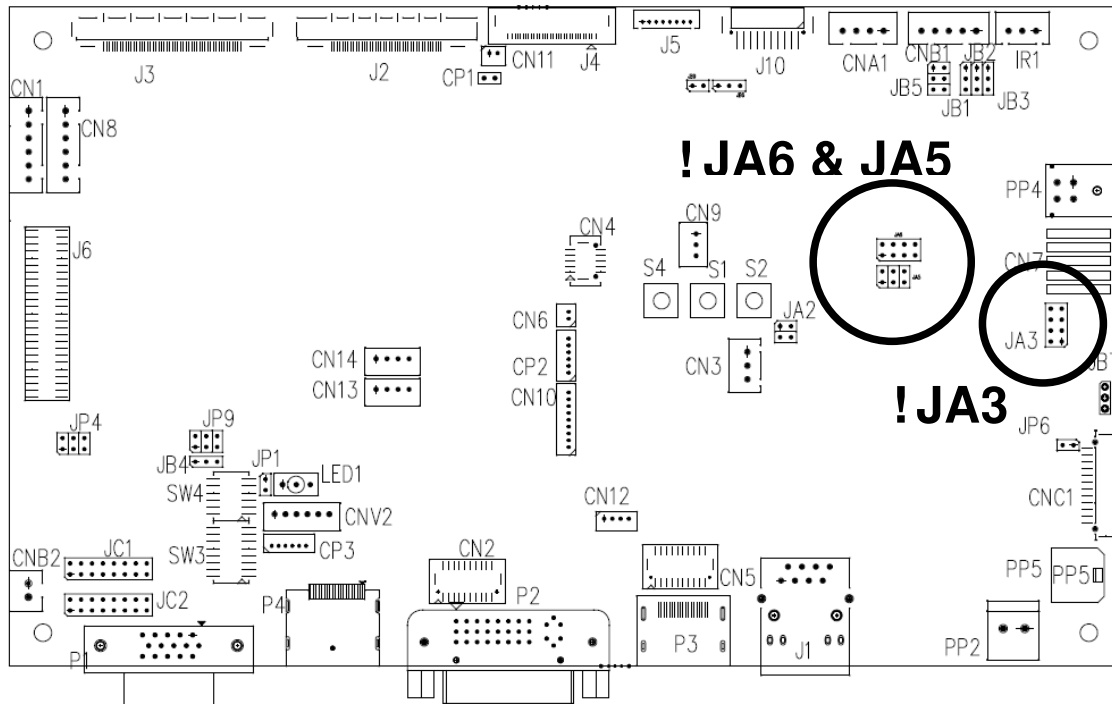

Table 2 : DIP Switch selection – SW3

GROUP 1

Pos #1	Pos #2	Pos #3	Pos.#4	Description	Panel resolution
For WUXGA panels					
OFF	ON	ON	OFF	LG LM260WU1-SLB1	1920x1200
ON	ON	ON	OFF	LG LM240WU2-SLA1	1920x1200
OFF	OFF	OFF	OFF	Sharp LQ445D3LZ19	1920x1080
ON	OFF	OFF	OFF	Samsung LTA460H2-L02	1920x1080
OFF	ON	OFF	OFF	Sharp LQ170M1LZ04	1920x1200
ON	ON	OFF	OFF	Samsung LTA700HH-LH1 (1 st trial testing)	1920x1080
OFF	OFF	ON	OFF	Samsung LTA700HH-LH1 (2 nd trial testing)	1920x1080
OFF	OFF	ON	ON	AU Optronics P645HW03 V0 (1920x1080)	1920x1080
OFF	OFF	ON	ON	AU Optronics P645HW03 V0	1920x1080
OFF	ON	ON	ON	Samsung ASI545FB01-0 OLED ⁽¹⁾	1920x1080
For UXGA panels					
OFF	OFF	OFF	OFF	Fujitsu FLC59UXC8V-02A	1600x1200
ON	OFF	OFF	OFF	Samsung LTM213U6-L01	1600x1200
For WXGA panels					
OFF	OFF	OFF	OFF	LG LC420W02-A4	1366x768
ON	OFF	OFF	OFF	Sharp LQ315T3LZ24	1366x768
ON	ON	OFF	OFF	Samsung LTA320W2-L01 / LTA230W1-L02	1366x768
ON	ON	ON	ON	NEC NL12876BC26-21 / Samsung LTM170W1-L01	1280x768
OFF	ON	ON	ON	CHI MEI N15414-L01	1280x800
OFF	OFF	ON	OFF	AU Optronics M190PW01	1440x900
OFF	OFF	ON	ON	Sharp LQ072K1LA03	1280x768
For SXGA panel					
OFF	OFF	OFF	OFF	Sharp LQ181E1LW31	1280x1024
ON	OFF	OFF	OFF	AU Optronics M170EN05	1280x1024
For XGA panel					
OFF	OFF	OFF	OFF	Sharp LQ150X1LGN2A Sharp LQ150X1LGB1	1024x768 1024x768
For WVGA panel					
OFF	OFF	OFF	OFF	NEC NL8048BC24-01	800x480
ON	OFF	OFF	OFF	Kyocera TCG085WV1AB-G00	800x480
ON	OFF	ON	OFF	Sharp LQ070Y3LG4A	800x480
Others					
OFF	ON	OFF	OFF	AU Optronics M201EW02 V8	1680x1050
ON	OFF	OFF	ON	Samsung LTM201M1-L01	1680x1050
OFF	OFF	ON	OFF	Samsung LT1430LA01	1920x480
OFF	OFF	ON	ON	Hitachi TX48D02VM0BAA ⁽¹⁾	1680x1050
OFF	ON	ON	OFF	NEC NL10260BC19-01D	1024x600
ON	ON	ON	OFF	AU Optronics M200RW01 Samsung LTM200KP01	1600x900 1600x900

Remark :

(1) Effective on V1.22.00.00 version or up.

Remark : The above panel timings are generated based on the panel specification. Some of the panel timings settings may not exactly to match the panel model we specified in this table.

Pos #5	Pos #6	Pos #7	Description
OFF	OFF	OFF	WUXGA
ON	OFF	OFF	UXGA
OFF	ON	OFF	SXGA
ON	ON	OFF	WXGA
OFF	OFF	ON	XGA
ON	OFF	ON	SVGA
OFF	ON	ON	VGA
ON	ON	ON	WVGA / Others

Pos. #8	Video lock	ON – Disable : Always fix the output be 60Hz. OFF – Enable : The output refresh rate locks to the input for 50Hz / 60Hz mode (other resolution lock the output be 60Hz.)
---------	------------	--

GROUP 2

Pos #1	Pos #2	Pos #3	Pos #4	Pos #5	Pos #6	Pos #7		Panel resolution
OFF	OFF	OFF	OFF	OFF	OFF	OFF	Sharp LQ235D1LW03 120Hz	1920x1080
OFF	OFF	OFF	OFF	OFF	OFF	ON	LG LM265SQ1-SLA1(Tested)	1920x1920
OFF	OFF	OFF	OFF	OFF	ON	OFF	LG LM270WQ1-SDE3	2560x1440
ON	OFF	OFF	OFF	OFF	ON	OFF	LG LM300WQ6-SL01	2560x1600

Pos. #8	Video lock	<p>ON – Disable : Always fix the output be 60Hz.</p> <p>OFF – Enable : The output refresh rate locks to the input for 50Hz / 60Hz mode (other resolution lock the output be 60Hz.)</p>
---------	------------	---

Table 3 : DIP switch selection – SW4

Pos. #	Function	Description
1	Panel timing group selection	OFF : Group 1 for SW3 dip switch setting ON : Group 2 for SW3 dip switch setting
2	Panel pixel format	OFF : Double Pixel ON : Single Pixel
3	Panel selection	ON : Single / Double pixel LVDS panel (controlled by SW4 position 2) OFF : Four channel LVDS panel
4	LVDS data mapping select (Refer to Table 2)	<p>If SW4 position 5 = OFF (8 bit)</p> <p>OFF : Mapping B ON : Mapping A</p> <p>Please adjust to get the correct picture. See as Appendix I for details of mapping of A and B.</p> <p>If SW4 position 5 = ON (10 bit)</p> <p>OFF : JEIDA (LVDS panel) ON : VESA (LVDS panel)</p> <p>Please adjust to get the correct picture. See as Appendix I for details of mapping of VESA and JEIDA.</p>
5	Output LVDS display mode selection	OFF : 8 bit ON : 10 bit
6	LVDS mapping swap	OFF : Normal ON : Swap

Support "Resolution default by EDID" for different resolution panel.

The controller will set the preferred timing based off the dip switch setting (SW3 position 1-7) selection, but also be able to go higher to 1920x1200. For example, if the panel is a 1024x768 and the dip switch setting are set for 1024x768. The preferred EDID resolution should be 1024x768. It should also have the capability to set the max resolution to 1920x1200.

* This function is only effective on V1.22.00.00 or later firmware revision.

CN1 – Slave RS-232 serial control: JST B6B-XH-A (Matching type : XHP-6)

PIN	SYMBOL	DESCRIPTION
1	EXT_MSTR2_SCL	Reserved
2	EXT_MSTR2_SDA	Reserved
3	VCC	+5V
4	TXD	RS-232 Tx data
5	GND	Ground
6	RXD	RS-232 Rx data

CN2 – Alternate DVI connector: JST BM20B-SRDS (Matching type : SHDR-20V-S-B)

PIN	SYMBOL	DESCRIPTION
1	GND	Digital Ground
2	GND	Digital Ground
3	RXC	TMDS Clock+
4	/RXC	TMDS Clock-
5	RX0	TMDS Data 0+
6	/RX0	TMDS Data 0-
7	RX1	TMDS Data 1+
8	/RX1	TMDS Data 1-
9	RX2	TMDS Data 2+
10	/RX2	TMDS Data 2-
11	GND	Ground (+5, Analog H/V Sync)
12	GND	Digital Ground
13	EXT_MSTR2_SCL	Reserved
14	EXT_MSTR2_SDA	Reserved
15	DDC_5V	+5V power supply for DDC (optional)
16	HPD	Hot plug detect
17	DDC_CLK	DDC Clock
18	DDC_DAT	DDC Data
19	NC	No connection
20	GND	Ground

CN4 – Panel connector: HIROSE DF20G-10DP-1V (Matching type : DF20A-10DS-1C)

PIN	SYMBOL	DESCRIPTION
1	OP1	Reserved
2	OP2	Reserved
3	OP3	Reserved
4	OP4	Reserved
5	IP1	Reserved
6	IP2	Reserved
7	IP3	Reserved
8	IP4	Reserved
9	EXT_MSTR2_SDA	Reserved
10	EXT_MSTR2_SCL	Reserved

CN5 - Alternate HDMI connector : JST BM20B-SRDS (Matching type : SHDR-20V-S-B)

PIN	SYMBOL	DESCRIPTION
1	GND	Ground
2	GND	Ground
3	RXC+	TMDS Data C+
4	RXC-	TMDS Data C-
5	RX0+	TMDS Data 0+
6	RX0-	TMDS Data 0-
7	RX1+	TMDS Data 1+
8	RX1-	TMDS Data 1-
9	RX2+	TMDS Data 2+
10	RX2-	TMDS Data 2-
11	GND	Ground
12	GND	Ground
13	MSTR2_SCL	Reserved
14	MSTR2_SDA	Reserved
15	DDC_5V	+5V power supply for DDC (optional)
16	HPD	Hot plug detection
17	DDC_SCL	DDC serial clock
18	DDC_SDA	DDC Data
19	CEC	Consumer Electronics Control(CEC) pin
20	VCC2	VCC 5V output

CN7 - 2x5 right angled header (Matching audio add-on board P/N 416940020-3 & Audio extend cable P/N 426009700-3)

PIN	SYMBOL	DESCRIPTION
1	VCC	Audio board logic power supply, +5V
2	VOLSEL0	Reserved
3	VOLSEL1	Reversed
4	TUNAUDSEL	Reserved
5	CLK/CNT	Reserved
6	GND	Ground
7	+12V/+24V	Audio board power supply, +12V/+24V
8	NC	No connection
9	NC	No connection
10	GND	Ground

CN8 – RS-232 serial control: JST B6B-XH-A (Matching type : XHP-6)

PIN	SYMBOL	DESCRIPTION
1	EXT_MSTR2_SCL	Reserved
2	EXT_MSTR2_SDA	Reserved
3	VCC	+5V
4	TXD	RS-232 Tx data
5	GND	Ground
6	RXD	RS-232 Rx data

CN9 – Ambient light sensor connector : JST B3B-PH-K (Matching type : PHR-3)

PIN	SYMBOL	DESCRIPTION
1	GND	Ground
2	VCC_5V	VCC 5V
3	ALSF	Ambient light sensing feedback

CN11 – SPDIF audio output connector : JST B3B-PH-K (Matching type : PHR-3)

PIN	SYMBOL	DESCRIPTION
1	SPDIF	SPDIF Digital audio output
2	GND	Ground

CNA1 - Auxiliary power output: JST B4B-XH-A (Matching type : XHP-4)

PIN	SYMBOL	DESCRIPTION
1	AUX 12V / 24V	+12V / +24V DC
2	GND	Ground
3	GND	Ground
4	AUX 5V	+5V DC, 500mA max

CNB1 – Backlight inverter connector: JST B5B-XH-A (Matching type : XHP-5)

PIN	SYMBOL	DESCRIPTION
1	GND	Ground
2	VBKL	+12V / +24V DC, backlight power supply
3	BLCTRL	On/Off control (enable) – see JB2 & JB3
4	BVR_WIP	Brightness VR – WIP
5	BVR_A	Brightness VR A

CNB2 – Backlight status input inverter connector: JST B2B-XH-A (Matching type : XHP-2)

PIN	SYMBOL	DESCRIPTION
1	BL_STATUS	Backlight status (Normal = High)
2	GND	Ground

CNC1 – OSD switch mount control, Hirose DF13A-12P-1.25H (Mating type : DF13-12S-1.25C)

PIN	SYMBOL	DESCRIPTION
1	PSWIN	Power button A
2	SW_ON	Power button B
3	BVR_A	Backlight Brightness VR pin A
4	BVR_WIP	Backlight Brightness R pin WIP
5	BVR_B	Backlight Brightness VR pin B (470 ohm resistor to +5V Vcc)
6	GND	Ground
7	MENU	OSD menu
8	-/LEFT	OSD -/Left
9	+ /RIGHT	OSD +/Right
10	SEL_DN	OSD Select down
11	SEL_UP	OSD Select up
12	NC	No connection

The VR for brightness depends on the inverter. The main power load for On/Off is handled by a relay on the controller.

CNV2 – Component (YPbPr) video input connector: JST 6-way, B6B-PH-K (Matching type : XHP-6)

PIN	SYMBOL	DESCRIPTION
1	A_Y1	Luma in / Green in
2	GND	Ground
3	A_Pb1	Pb in / Blue in
4	GND	Ground
5	A_Pr 1	Pr in / Red in
6	GND	Ground

IR1 – Infra-Red sensor connector: JST B3B-XH-A (Matching type : XHP-3)

PIN	SYMBOL	DESCRIPTION
1	GND	Ground
2	STDBY_Vcc	Stand by voltage
3	IR Data	IR data

J2 – LVDS output connector: JAE FI-RE41S-HF (Matching type : JAE FI-RE41HL)

PIN	SYMBOL	DESCRIPTION
1	GND	Ground
2	LVDS_OUT2_B0-	Negative differential LVDS data bit B0
3	LVDS_OUT2_B0+	Positive differential LVDS data bit B0
4	LVDS_OUT2_B1-	Negative differential LVDS data bit B1
5	LVDS_OUT2_B1+	Positive differential LVDS data bit B1
6	LVDS_OUT2_B2-	Negative differential LVDS data bit B2
7	LVDS_OUT2_B2+	Positive differential LVDS data bit B2
8	LVDS_OUT2_BC-	Negative LVDS clock for B channel
9	LVDS_OUT2_BC+	Positive LVDS clock for B channel
10	GND	Ground
11	LVDS_OUT2_B3-	Negative differential LVDS data bit B3
12	LVDS_OUT2_B3+	Positive differential LVDS data bit B3
13	GND	Ground
14	LVDS_OUT2_B4-	Negative differential LVDS data bit B4
15	LVDS_OUT2_B4+	Positive differential LVDS data bit B4
16	GND	Ground
17	LVDS_OUT2_A0-	Negative differential LVDS data bit A0
18	LVDS_OUT2_A0+	Positive differential LVDS data bit A0
19	LVDS_OUT2_A1-	Negative differential LVDS data bit A1
20	LVDS_OUT2_A1+	Positive differential LVDS data bit A1
21	LVDS_OUT2_A2-	Negative differential LVDS data bit A2
22	LVDS_OUT2_A2+	Positive differential LVDS data bit A2
23	LVDS_OUT2_AC-	Negative LVDS clock for A channel
24	LVDS_OUT2_AC+	Positive LVDS clock for A channel
25	GND	Ground
26	LVDS_OUT2_A3-	Negative differential LVDS data bit A3
27	LVDS_OUT2_A3+	Positive differential LVDS data bit A3
28	GND	Ground
29	LVDS_OUT2_A4-	Negative differential LVDS data bit A4
30	LVDS_OUT2_A4+	Positive differential LVDS data bit A4
31	GND	Ground
32	GND	Ground
33	GND	Ground
34	GND	Ground
35	GND	Ground
36	GND	Ground
37	NC	No connection
38	NC	No connection
39	NC	No connection
40	NC	No connection
41	NC	No connection

J3 – LVDS output connector: JAE FI-RE51S-HF (Matching type : JAE FI-RE51HL)

PIN	SYMBOL	DESCRIPTION
1	VLCD HV	Panel power supply (+12V / 18V) (selected by JA3, JA5 & JA6)
2	VLCD HV	Panel power supply (+12V / 18V) (selected by JA3, JA5 & JA6)
3	VLCD HV	Panel power supply (+12V / 18V) (selected by JA3, JA5 & JA6)
4	VLCD HV	Panel power supply (+12V / 18V) (selected by JA3, JA5 & JA6)
5	VLCD HV	Panel power supply (+12V / 18V) (selected by JA3, JA5 & JA6)
6	VLCD LV	Panel power supply (3,3V/5V) (selected by JA3, JA5 & JA6)
7	VLCD LV	Panel power supply (3,3V/5V) (selected by JA3, JA5 & JA6)
8	VLCD LV	Panel power supply (3,3V/5V) (selected by JA3, JA5 & JA6)
9	VLCD LV	Panel power supply (3,3V/5V) (selected by JA3, JA5 & JA6)
10	VLCD LV	Panel power supply (3,3V/5V) (selected by JA3, JA5 & JA6)
11	GND	Ground
12	GND	Ground
13	GND	Ground
14	GND	Ground
15	GND	Ground
16	OP1	-
17	OP2	-
18	OP3	-
19	OP4	-
20	GND	Ground
21	GND	Ground
22	LVDS_OUT1_A4+	Positive differential LVDS data bit A4
23	LVDS_OUT1_A4-	Negative differential LVDS data bit A4
24	LVDS_OUT1_A3+	Positive differential LVDS data bit A3
25	LVDS_OUT1_A3-	Negative differential LVDS data bit A3
26	GND	Ground
27	LVDS_OUT1_AC+	Positive LVDS clock for A channel
28	LVDS_OUT1_AC-	Negative LVDS clock for A channel
29	GND	Ground
30	LVDS_OUT1_A2+	Positive differential LVDS data bit A2
31	LVDS_OUT1_A2-	Negative differential LVDS data bit A2
32	LVDS_OUT1_A1+	Positive differential LVDS data bit A1
33	LVDS_OUT1_A1-	Negative differential LVDS data bit A1
34	LVDS_OUT1_A0+	Positive differential LVDS data bit A0
35	LVDS_OUT1_A0-	Negative differential LVDS data bit A0
36	GND	Ground
37	LVDS_OUT1_B4+	Positive differential LVDS data bit B4
38	LVDS_OUT1_B4-	Negative differential LVDS data bit B4
39	LVDS_OUT1_B3+	Positive differential LVDS data bit B3
40	LVDS_OUT1_B3-	Negative differential LVDS data bit B3
41	GND	Ground
42	LVDS_OUT1_BC+	Positive LVDS clock for B channel
43	LVDS_OUT1_BC-	Negative LVDS clock for B channel
44	GND	Ground
45	LVDS_OUT1_B2+	Positive differential LVDS data bit B2
46	LVDS_OUT1_B2-	Negative differential LVDS data bit B2
47	LVDS_OUT1_B1+	Positive differential LVDS data bit B1
48	LVDS_OUT1_B1-	Negative differential LVDS data bit B1
49	LVDS_OUT1_B0+	Positive differential LVDS data bit B0
50	LVDS_OUT1_B0-	Negative differential LVDS data bit B0
51	GND	Ground

J4 – Display port output for panel connector: I-PEX 20455-030E-12

(Matching type : I-PEX 20454-030T)

PIN	SYMBOL	DESCRIPTION
1	GND	Ground
2	GND	Ground
3	GND	Ground
4	GND	Ground
5	VLCD_LV	Panel power supply (3,3V/5V) (selected by JA3, JA5 & JA6)
6	VLCD_LV	Panel power supply (3,3V/5V) (selected by JA3, JA5 & JA6)
7	VLCD_LV	Panel power supply (3,3V/5V) (selected by JA3, JA5 & JA6)
8	VLCD_LV	Panel power supply (3,3V/5V) (selected by JA3, JA5 & JA6)
9	NC	No connection
10	DP_PWR	Power for connector (3.3 V 500 mA)
11	Return	Return for Power
12	Hot Plug	Hot Plug Detect
13	AUX CH (n)	Auxiliary Channel (negative)
14	GND	Ground
15	AUX CH (p)	Auxiliary Channel (positive)
16	CONFIG2	connected to Ground
17	CONFIG1	connected to Ground
18	ML_Lane 3 (n)	Lane 3 (negative)
19	GND	Ground
20	ML_Lane 3 (p)	Lane 3 (positive)
21	ML_Lane 2 (n)	Lane 2 (negative)
22	GND	Ground
23	ML_Lane 2 (p)	Lane 2 (positive)
24	ML_Lane 1 (n)	Lane 1 (negative)
25	GND	Ground
26	ML_Lane 1 (p)	Lane 1 (positive)
27	ML_Lane 0 (n)	Lane 0 (negative)
28	GND	Ground
29	ML_Lane 0 (p)	Lane 0 (positive)
30	GND	Ground

J5 – Panel power output connector: Molex 53261-0871, (Matching type : 51021-0800)

PIN	SYMBOL	DESCRIPTION
1	VDD (3,3V/5V)	Panel power supply (3,3V/5V)
2	VDD (3,3V/5V)	Panel power supply (3,3V/5V)
3	GND	Ground
4	GND	Ground
5	GND	Ground
6	VDD (12V/18V)	Panel power supply (12V/18V)
7	VDD (12V/18V)	Panel power supply (12V/18V)
8	VDD (12V/18V)	Panel power supply (12V/18V)

**J6 – Reserved for Digital interface for SDI / Video mux board (AVD-1000) interface connector: 2 x 25 ways, 2.54x1.27 header (This connector function is not implemented yet)
(Matching ribbon cable : P/N 426171100-3)**

PIN	SYMBOL	DESCRIPTION
1	GND	Ground
2	GND	Ground
3	CbCr0 (Input)	CbCr0 (Input)
4	Y0 (Input)	Y0 (Input)
5	CbCr1 (Input)	CbCr1 (Input)
6	Y1 (Input)	Y1 (Input)
7	CbCr2 (Input)	CbCr2 (Input)
8	Y2 (Input)	Y2 (Input)
9	CbCr3 (Input)	CbCr3 (Input)
10	Y3 (Input)	Y3 (Input)
11	CbCr4 (Input)	CbCr4 (Input)
12	Y4 (Input)	Y4 (Input)
13	CbCr5 (Input)	CbCr5 (Input)
14	Y5 (Input)	Y5 (Input)
15	CbCr6 (Input)	CbCr6 (Input)
16	Y6 (Input)	Y6 (Input)
17	CbCr7 (Input)	CbCr7 (Input)
18	Y7 (Input)	Y7 (Input)
19	CbCr8 (Input)	CbCr8 (Input)
20	Y8 (Input)	Y8 (Input)
21	CbCr9 (Input)	CbCr9 (Input)
22	Y9 (Input)	Y9 (Input)
23	N.C	No connection
24	N.C	No connection
25	VCC(5V)	VCC(5V)
26	VCC (5V)	VCC (5V)
27	CLOCK (Input)	CLOCK (Input)
28	SCLK_TCK(control pin)	SCLK_TCK(control pin)
29	GND	Ground
30	SDIN_TDI(control pin)	SDIN_TDI(control pin)
31	Field (Input)	Field (Input)
32	SDOUT_TDO(control pin)	SDOUT_TDO(control pin)
33	V sync (Input)	V sync (Input)
34	CS_TMS(control pin)	CS_TMS(control pin)
35	H sync (Input)	H sync (Input)
36	GND	Ground
37	DE (Input)	DE (Input)
38	N.C	No connection
39	N.C	No connection
40	N.C	No connection
41	HDSDI_LOCK (control pin)	HDSDI_LOCK (control pin)
42	N.C	No connection
43	GND	Ground
44	GND	Ground
45	N.C	No connection
46	N.C	No connection
47	N.C	No connection
48	HDSDI_IPSEL (control pin)	HDSDI_IPSEL (control pin)
49	Videomux_CAB (control pin)	Video mux detected pin
50	HDSDI_CAB (control pin)	HDSDI_CAB (control pin)

J10 – On-board LED backlight driver connection : Molex 53261-1000 (Matching type : Molex 51021-1000)

PIN	SYMBOL	DESCRIPTION
1	LED_VLED1+	Channel A – Anode
2	LED_VLED1+	Channel A – Anode
3	LED_CH4	Channel A – Cathode 1
4	LED_CH3	Channel A – Cathode 2
5	LED_CH2	Channel A – Cathode 3
6	LED_CH1	Channel A – Cathode 4
7	NC	No Connection
8	NC	No Connection
9	NC	No Connection
10	NC	No Connection

LED1 – Status LED connector: 3-pin header

PIN	DESCRIPTION
1	Green LED pin (anode)
2	LED pin common (cathode)
3	Red LED pin (anode)

P1 - Analog VGA in - 15 way connector

PIN	SYMBOL	DESCRIPTION
1	PCR	Red, analog
2	PCG	Green, analog
3	PCB	Blue analog
4	ID2	Reserved for monitor ID bit 2 (grounded)
5	DGND	Digital ground
6	AGND	Analog ground red
7	AGND	Analog ground green
8	AGND	Analog ground blue
9	DDC 5V	+5V power supply for DDC (optional)
10	DGND	Digital ground
11	ID0	Reserved for monitor ID bit 0 (grounded)
12	DDC SDA	DDC serial data
13	HS_IN	Horizontal sync or composite sync, input
14	VS_IN	Vertical sync, input
15	DDC_SCL	DDC serial clock

P2 – DVI-D dual link in

PIN	SYMBOL	DESCRIPTION
1	/RX2	TMDS Data 2-
2	RX2	TMDS Data 2+
3	GND	Digital Ground
4	/Rx4	TMDS Data 4-
5	Rx4	TMDS Data 4+
6	DDC_CLK	DDC Clock
7	DDC_DAT	DDC Data
8	NC	No connection
9	/RX1	TMDS Data 1-
10	RX1	TMDS Data 1+
11	GND	Digital Ground
12	/Rx3	TMDS Data 3-
13	Rx3	TMDS Data 3+
14	DDC 5V	+5V power supply for DDC (optional)
15	GND	Ground (+5, Analog H/V Sync)
16	HPD	Hot Plug Detect
17	/RX0	TMDS Data 0-
18	RX0	TMDS Data 0+
19	GND	Digital Ground
20	/Rx5	TMDS Data 5-
21	Rx5	TMDS Data 5+
22	GND	Digital Ground
23	RXC	TMDS Clock+
24	/RXC	TMDS Clock-
C1	NC	No connection
C2	NC	No connection
C3	NC	No connection
C4	NC	No connection
C5	GND	Ground
C6	NC	No connection

P3 – HDMI connector

PIN	SYMBOL	DESCRIPTION
1	DATA2+	TMDS Data2+
2	DATA2S	TMDS Data2 Shield
3	DATA2-	TMDS Data2-
4	DATA1+	TMDS Data1+
5	DATA1S	TMDS Data1 Shield
6	DATA1-	TMDS Data1-
7	DATA0+	TMDS Data0+
8	DATA0S	TMDS Data0 Shield
9	DATA0-	TMDS Data0-
10	CLK+	TMDS Clock+
11	CLK@	TMDS Clock Shield

Specifications subject to change without notice

12	CLK-	TMDS Clock-
13	CEC	CEC
14	NC	No connection
15	SCL	SCL (I ² C Serial Clock for DDC)
16	SDA	SDA (I ² C Serial Data Line for DDC)
17	CEC/GND	Ground
18	+5V	+5 V Power (max 50 mA)
19	HPDET	Hot Plug Detect

P4 – Display Port input

PIN	SYMBOL	DESCRIPTION
1	ML_Lane 0 (p)	Lane 0 (positive)
2	GND	Ground
3	ML_Lane 0 (n)	Lane 0 (negative)
4	ML_Lane 1 (p)	Lane 1 (positive)
5	GND	Ground
6	ML_Lane 1 (n)	Lane 1 (negative)
7	ML_Lane 2 (p)	Lane 2 (positive)
8	GND	Ground
9	ML_Lane 2 (n)	Lane 2 (negative)
10	ML_Lane 3 (p)	Lane 3 (positive)
11	GND	Ground
12	ML_Lane 3 (n)	Lane 3 (negative)
13	CONFIG1	connected to Ground ¹⁾
14	CONFIG2	connected to Ground ¹⁾
15	AUX CH (p)	Auxiliary Channel (positive)
16	GND	Ground
17	AUX CH (n)	Auxiliary Channel (negative)
18	Hot Plug	Hot Plug Detect
19	GND	Ground
20	DP_PWR	Power for connector (3.3 V 500 mA)

PP2 – Alternate 12V/24VDC input power supply

PIN	DESCRIPTION
1	+12VDC / 24VDC in
2	Ground

PP4 – External panel power input

PIN	DESCRIPTION
1	External panel power
2	Ground
3	External panel power
4	Ground

PP5 – 12V/24VDC input power supply

PIN	DESCRIPTION
1	+12V / +24VDC
2	Ground

CONTROLLER DIMENSIONS

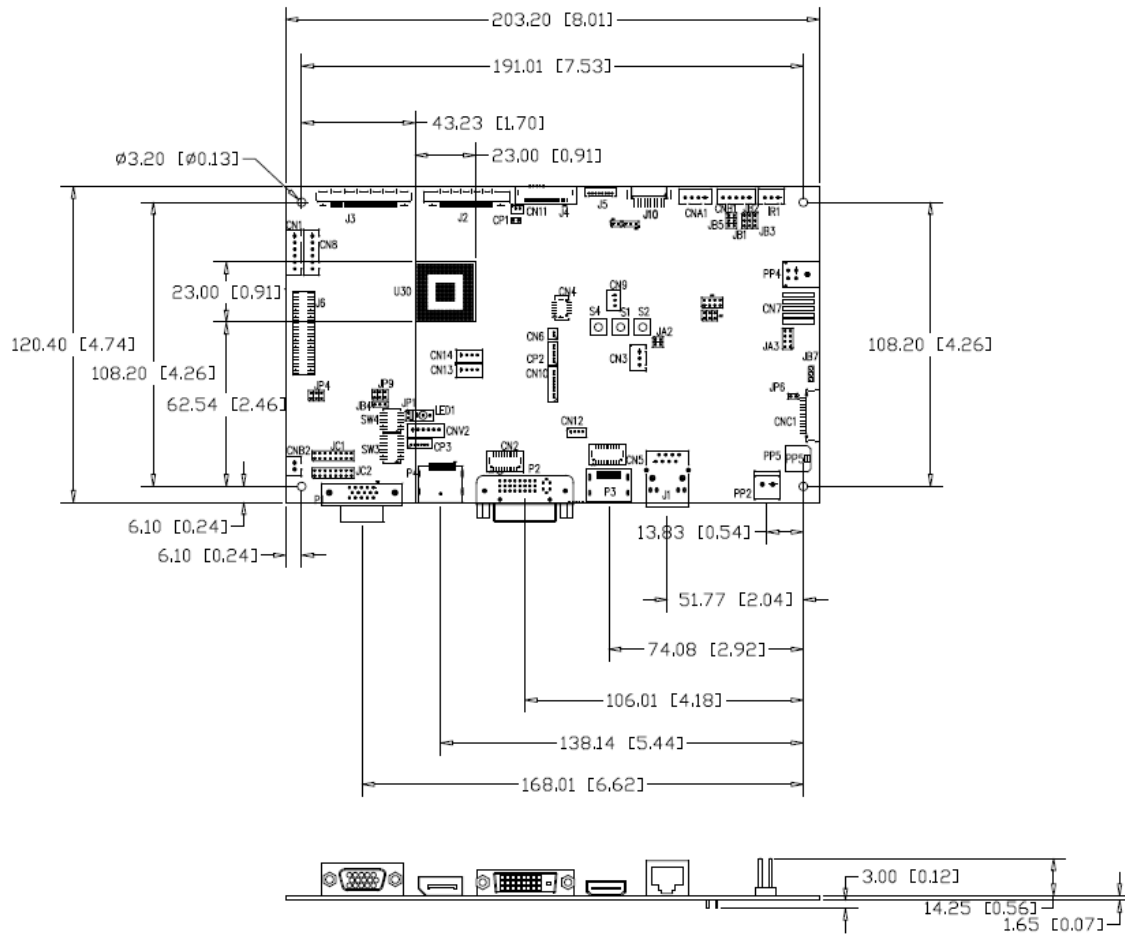

Ready-made 3D Pro-E (SLDPRT) drawing files - Save time and effort for your system volumetric analysis design. Includes jpg file previews. Please go to download at <http://www.digitalview.com/products/svx-2560-lcd-controller>

The maximum thickness of the controller is 18.9mm with or without video add-on board (measured from bottom of PCB to top of components, including any underside components & leads). We recommend clearances of:

- 5mm from bottom of PCB - if mounting on a metal plate we also recommend a layer of suitable insulation material is added to the mounting plate surface.
- 10mm above the components
- 3~5mm around the edges

Any of the holes shown above can be used for mounting the PCB, they are 3.2mm in diameter.

CAUTION: Ensure adequate insulation is provided for all areas of the PCB with special attention to high voltage parts such as the inverter.

APPLICATION NOTES

USING THE CONTROLLER WITHOUT BUTTONS ATTACHED

This is very straightforward:

- Firstly setup the controller/display system with the buttons. With controls attached and display system active make any settings for color, tint and image position as required then switch everything off.
- Remove the control switches, the 12-way (CNC1) cable.
- Use a jumper or similar to connect pins 1 & 2 on CNC1, this will fix the board On.
- Refer to inverter specifications for details as to fixing brightness to a desired level, this may require a resistor, an open circuit or closed circuit depending on inverter.

Summary: On CNC1 the only pins that are used are for On/Off and Brightness (if controller mounted inverter is used). On CNC1 the pins are for momentary type buttons so it doesn't matter that no buttons are attached.

INVERTER CONNECTION

There are potentially 3 issues to consider with inverter connection:

- Power
- Enable
- Brightness

Please read the following sections for a guide to these issues.

Inverter Power: As per the table for CNB1 pin 1 is ground and pin 2 provides 12V/24V DC. This should be matched with the inverter specification: see table.

CNB1	
PIN	DESCRIPTION
1	Ground
2	+12V/+24VDC

Remark: For higher power inverter, more current (for 12V/24V) can be taken from CNA1 pin 1.

Enable: This is a pin provided on some inverters for On/Off function and is used by this panel controller for VESA DPMS compliance. If the inverter does not have an enable pin or the enable pin is not used then DPMS will not be operational. Pin 3 should be matched to the inverters specification for the 'enable' or 'disable' pin.

CNB1	
PIN	DESCRIPTION
3	Enable

Further, jumpers JB2 & JB3 should be set to match the inverters specification for the enable pin power and High or Low setting: see table.

Ref	Purpose	Note
JB2	Inverter enable voltage	1-2 H = 3.3V, 2-3 H = 5V, OPEN H = open collector
JB3	Inverter control	1-2 H = On, 2-3 L = On

Brightness: There are various methods for brightness control and it is important to consider the specifications for the inverter to be used. Generally the situation is:

- Brightness can control by using a resistor or VR (Variable Resistor).
- Brightness controlled by adding a circuit such as PWM (Pulse Width Modulation).
- No adjustment of brightness is possible.

CNB1 pins 4 & 5 are available for connecting to an inverter or circuit where VR control is supported.

CNB1	
PIN	DESCRIPTION
4	VR WIP
5	VR A

This can then be matched with function controls connected to CNC1 pins 4 & 3 or 5: see table.

CNC1	
PIN	DESCRIPTION
3	VR A
4	VR WIP
5	VR B

Design Guideline for making VR circuitry :

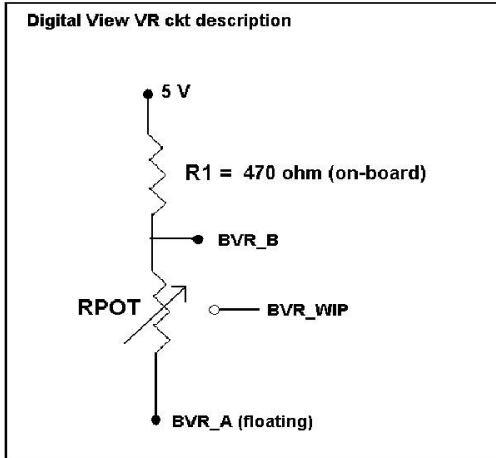

Signal description / Notes :

- 1) R1 : 470ohm on board
- 2) RPOT is an external potentiometer (in-line dip style) that can be plugged directly into CNC1 pins 3,4,5. RPOT must be supplied / installed by user.
- 3) BVR_B : Voltage tapped from “top” of potentiometer, the node of R1 and RPOT.
- 4) BVR_WIP : Voltage tapped from wiper arm of RPOT.
- 5) BVR_A : Voltage tapped from “bottom” of RPOT.

Note : BVR_A voltage is left floating on the controller board. To use this circuit, you need to tie this point to a potential (usually GND, available at CNC1 pin 6).

CNB1 – Backlight inverter connector: JST B5B-XH-A (Matching type : XHP-5)

PIN	SYMBOL	DESCRIPTION
1	GND	Ground
2	VBKL	+12V/24VDC, backlight power supply
3	BLCTRL	On/Off control (enable) – see JB2 & JB3
4	BVR_WIP	Brightness VR - WIP
5	BVR_A	Brightness VR A

CNC1 – OSD switch mount control, Hirose DF13A-12P-1.25H (Mating type : DF13-12S-1.25C)

PIN	SYMBOL	DESCRIPTION
1	PSWIN	Power button A
2	SW_ON	Power button B
3	BVR_A	Backlight Brightness VR pin A
4	BVR_WIP	Backlight Brightness R pin WIP
5	BVR_B	Backlight Brightness VR pin B (470 ohm resistor to +5V Vcc)
6	GND	Ground
7	MENU	OSD menu
8	-/LEFT	OSD -/Left
9	+ /RIGHT	OSD +/Right
10	SEL_DN	OSD Select down
11	SEL_UP	OSD Select up
12	NC	No connection

The VR for brightness depends on the inverter. The main power load for On/Off is handled by a relay on the controller.

Example for circuit design :

- 1.) Choose RPOT = 10K
- 2.) Tie BVR_A to GND
- 3.) Circuit analysis gives BVR_WIP as the following (see Figure 1)

$$BVR_WIP = 5 \times (Rbc/10.47)$$

where BVR_WIP is in Volts.
And Rbc is the resistance from the wiper arm to bottom of pot in Kohms.

To evaluate, plug in different values of Rbc :

Rbc	BVR_WIP
0	0 V
2.5 K	1.2 V
5 K	2.4 V
7.5 K	3.6 V
10 K	4.8 V

So this circuit could provide Brightness adjust voltage ranging from 0V to 5V.

Specifications subject to change without notice

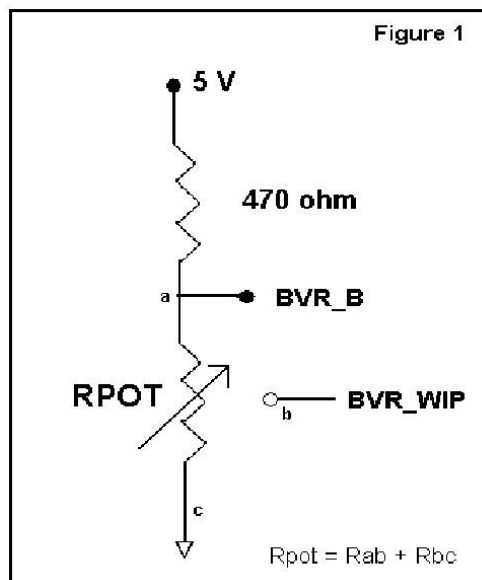

TROUBLESHOOTING

General

A general guide to troubleshooting a flat panel display system it is worth considering the system as separate elements, such as:

- Controller (jumpers, PC settings)
- Panel (controller, cabling, connection, panel, PC settings)
- Backlight (inverter, cabling, backlight tubes)
- Cabling
- Computer system (display settings, operating system)

Through step by step cross checking with instruction manuals and a process of elimination to isolate the problem it is usually possible to clearly identify the problem area.

No image:

- If the panel backlight is not working it may still be possible to just see some image on the display.
- A lack of image is most likely to be caused by incorrect connection, lack of power, failure to provide a signal or incorrect graphic card settings.

Image position:

If it is impossible to position the image correctly, i.e. the image adjustment controls will not move the image far enough, then test using another graphics card. This situation can occur with a custom graphics card that is not close to standard timings or if something is in the graphics line that may be affecting the signal such as a signal splitter (please note that normally a signal splitter will not have any adverse effect).

Image appearance:

- A faulty panel can have blank lines, failed sections, flickering or flashing display
- Incorrect graphics card refresh rate, resolution or interlaced mode will probably cause the image to be the wrong size, to scroll, flicker badly or possibly even no image.
- Incorrect jumper settings on the controller may cause everything from total failure to incorrect image. CAUTION: Do not set the panel power input incorrectly.
- Sparkling on the display: faulty panel signal cable.
- Found "Loading" message displayed on screen message at HDMI / DVI input indicates the unstable HDMI/DVI source detected (especially connected to HDMI splitter) causing flashing image.

Backlight:

Items to check include: Power input, Controls, Inverter and Tubes generally in this order.

If half the screen is dimmer than the other half:

- Check cabling for the inverter.
- For a specific backlight tube check the AC pins orientation (CAUTION: Never reverse any DC power pins).

Also:

- If adjusting brightness control has no effect the chances are that the VR rating or method of adjusting brightness is not compatible or correctly connected to the inverter.
- If system does not power down when there is a loss of signal

Continued failure:

If unit after unit keeps failing consider and investigate whether you are short circuiting the equipment or doing something else seriously wrong.

Generally after common sense issues have been resolved we recommend step by step substitution of known working parts to isolate the problem.

SPECIFICATIONS

Panel compatibility	Compatible with 2560x1600, 2560x1440, 1920x1920, 1920x1200, 1920x1080, 1920x480, 1680x1050, 1600x1200, 1600x900, 1440x900, 1366x768, 1280x1024, 1280x800, 1280x768 1024x768, 1024x600, 800x600, 800x480 and 640x480 resolutions of TFT LCD panels. A specified BIOS and some factory adjustment may be required for individual panel timings.
No. of colors	Up to 3 x 10 bit providing 1.06 billion colors.
Panel power	DC 3.3V, 5V, 12V, 18V
Panel signal	LVDS
Vertical refresh rate	60Hz at 2560x1600, 120Hz at 1920x1200, 1920x1080, 60Hz at 1920x1920, up to UXGA 75Hz or other lower resolution
Display clock maximum	165MHz
ADC clock maximum	195 MHz
DVI differential input clock maximum	348.5MHz
Graphics formats	Standard VESA VGA, SVGA, XGA, SXGA, WXGA, UXGA, WUXGA Other special formats through specified BIOS and factory adjustment.
Graphics auto mode detect	VGA, SVGA, XGA, SXGA, WXGA, UXGA & WUXGA interlaced and non-interlaced
Standard input at source (analog RGB)	VGA analog (15 pin) standard with automatic detection of: Digital Separate Sync; Sync On Green.
Video formats	PAL, NTSC & SECAM
Video inputs	ARGB DVI-D Component video HDMI 1.4 Display Port 1.2
Functions display	On screen display (OSD) of functions
OSD menu functions	Image controls: Panel brightness/contrast, Saturation, Hue, Color temperature, Sharpness, Aspect ratio etc.
OSD menu controls available	Power On/Off Backlight brightness OSD Menu OSD Select up OSD Select down Setting + Setting -
Control interface	Buttons, RS-232, Remote control, Ethernet Control
Settings memory	Settings are stored in non volatile memory
PC Connectivity	VGA / SVGA / XGA / SXGA / UXGA / WUXGA analog or digital
Controller dimensions	203.2mm x 120.4mm (8.01" x 4.74")
Power consumption	10w approx. (not including panel power consumption)
Power load maximum	The controller has an overall 3Amp current limit.
Input voltage	12V/24VDC +/- 5%
Power protection	Fuse fitted (Resettable)
DC Power handling	Reverse power polarity protection is equipped on the board
Storage temperature limits	-40°C to +70°C
Operating temperature limits	0°C to +60°C
Use of memory on board	- 2pcs DDR3-1600 1Gbit which is a volatile memory for system processing and frame buffer - 1pc flash 32Mbit which is a non-volatile(NVRAM) memory for system program - 42pcs EEPROM 2Kbit which is a non-volatile(NVRAM) memory for DDC information. - 1pc EEPROM 512Kbit which is a non-volatile(NVRAM) for system and user settings - 1pc flash 2Mbit which is a non-volatile(NVRAM) memory for IP-60 web page - IP-60's network processor included 524KByte non-volatile(NVRAM) for IP-60 system program

NOTES

Please note the following:

- For specific panel setup a sample of an LCD may be required (this will be returned) and a copy of the full technical specifications for the panel from the manufacturer.
- Re-layout and custom development services are available.

APPENDIX I – SIGNAL SUPPORT MODE TABLE

ARGB (P1) PORT :

Mode	Resolution	Clk [MHz]	Horizontal freq [KHz]	Vertical freq [Hz]	Sync Mode
V_60	640x480 60Hz	25.175	31.469	59.940	Digital Separate Sync
V_60	640x480 60Hz	25.175	31.469	59.940	Composite Sync
V_72	640x480 72Hz	31.500	37.861	72.809	Digital Separate Sync
V_72	640x480 72Hz	31.500	37.861	72.809	Sync On Green
V_75	640x480 75Hz	31.500	37.500	75.000	Digital Separate Sync
V_75	640x480 75Hz	31.500	37.500	75.000	Sync On Green
SV_56	800x600 56Hz	36.000	35.156	56.250	Digital Separate Sync
SV_60	800x600 60Hz	40.000	37.879	60.317	Digital Separate Sync
SV_60	800x600 60Hz	40.000	37.879	60.317	Sync On Green
SV_72	800x600 72Hz	50.000	48.077	72.188	Digital Separate Sync
SV_72	800x600 72Hz	50.000	48.077	72.188	Sync On Green
SV_75	800x600 75Hz	49.500	46.875	75.000	Digital Separate Sync
SV_75	800x600 75Hz	49.500	46.875	75.000	Sync On Green
X_60	1024x768 60Hz	65.000	48.363	60.004	Digital Separate Sync
X_60	1024x768 60Hz	65.000	48.363	60.004	Sync On Green
X_70	1024x768 70Hz	75.000	56.476	70.069	Digital Separate Sync
X_70	1024x768 70Hz	75.000	56.476	70.069	Sync On Green
X_75	1024x768 75Hz	78.750	60.023	75.029	Digital Separate Sync
X_75	1024x768 75Hz	78.750	60.023	75.029	Sync On Green
SX_60	1280x1024 60Hz	108	63.81	60.020	Digital Separate Sync
SX_60	1280x1024 60Hz	108	63.81	60.020	Sync On Green
SX_75	1280x1024 75Hz	135	79.976	75	Digital Separate Sync
SX_75	1280x1024 75Hz	135	79.976	75	Sync On Green
WXGA	1280x768 60Hz	79.5	47.776	59.87	Digital Separate Sync

Specifications subject to change without notice

WXGA	1280x768 60Hz	79.5	47.776	59.87	Sync On Green
WXGA	1360x768 60Hz	85.5	47.712	60.015	Digital Separate Sync
WXGA	1360x768 60Hz	85.5	47.712	60.015	Sync On Green
WXGA	1366x768 60Hz	87.75	47.852	59.964	Digital Separate Sync
WXGA+	1440x900 60Hz	88.75	55.469	59.901	Digital Separate Sync
HD+	1600x900 60Hz	97.75	55.54	59.978	Digital Separate Sync
WUX_60	1920x1080 60Hz	172.8	67.5	60	Digital Separate Sync
WUX_60	1920x1080 60Hz	172.8	67.5	60	Composite Sync

Remark :

The controller has been designed to take a very wide range of input signals however to optimize the PC's graphics performance we recommend choosing 60Hz vertical refresh rate. To support on higher refresh rate over 60Hz, the LCD panel may not support.

DVI input port :

Resolution
640x480 60Hz
640x480 75Hz
800x600 56Hz
800x600 60Hz
800x600 72Hz
800x600 75Hz
1024x768 60Hz
1024x768 70Hz
1024x768 75Hz
1280x768 60Hz
1280x1024 60Hz
1280x1024 75Hz
1366x768 60Hz
1440x900 60Hz
1600x900 60Hz
1600x1200 60Hz
1920x1080 60Hz
1920x1080 60Hz
1920x1080 59Hz
1920x1080 50Hz
2560x1600 60Hz

HDMI input port :

Resolution
640x480 60Hz
640x480 72Hz
640x480 75Hz
800x600 56Hz
800x600 60Hz
800x600 72Hz
800x600 75Hz
1024x768 60Hz
1024x768 70Hz
1024x768 75Hz
1280x768 60Hz
1280x1024 60Hz
1280x1024 75Hz
1366x768 60Hz
1400x1050 60Hz
1440x900 60Hz
1600x900 60Hz
1600x1200 60Hz
1680x1050 60Hz
1920x1200 60Hz
2560x1600 60Hz

Display port input port :

Resolution
640x480 60Hz
640x480 72Hz
640x480 75Hz
720x480 60Hz
720x576 50Hz
800x600 56Hz
800x600 60Hz
800x600 72Hz
800x600 75Hz
1024x768 60Hz
1024x768 70Hz
1024x768 75Hz
1280x768 60Hz
1280x1024 60Hz
1280x1024 75Hz
1400x1050 60Hz
1440x900 60Hz
1600x900 60Hz
1600x1200 60Hz
1680x1050 60Hz
1920x1200 60Hz
2560x1600 60Hz

Component video port :

Mode
720p60
720p59.94
720p50
720p30
720p29.97
720p24
720p23.976
1080p30
1080p29.97
1080p25
1080p24
1080p23.98

Appendix II – RS-232 control protocols

RS-232 Serial control (Baud rate 2400, 8 bits, 1 stop bit and no parity)

Physical connection :

Controller side
Connector interface : CN8
Mating connector : JST XHP-6

Computer side
Connector interface : Serial port
Mating connector : DB9 Female

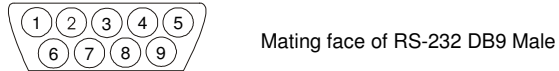

PIN#	Description
4	RS-232 Tx Data
5	Ground
6	RS-232 Rx Data

PIN#	Description
2	RS-232 Rx Data
3	RS-232 Tx Data
5	Ground

Remark :

(1) : RS-232 connection cable, 600mm P/N 4260902-00 can be ordered separately for connection.

Software connection :

The OSD function can be controlled through sending the RS-232 protocol.

The RS-232 program can be custom-made to fit for application or it can be used the serial control program, like Accessport, Telix or Serial Utility program developed by DigitalView. Please contact your local support for information.

1. Commands to implement switch mount control buttons

Function	Command	Description	Remark
Menu button	0xf7	Menu button pressed	Button equivalent
Select-down button	0xfa	Select-down button pressed	Button equivalent
Select-up button	0xfb	Select-up button pressed	Button equivalent
Right/+ button	0xfc	Right/+ button pressed	Button equivalent
Left/- button	0xfd	Left/- button pressed	Button equivalent

2. Parameter setting - immediate, relative, reset and query

Function	Command	Description	Acknowledge (if enabled)
Brightness control	0x81, nn "+" "-" "r" "R" "?" "m" "n" "i", ss, nn "o", ss,	Set brightness = value/increment/decrement Reset Query Current Source Maximum query *1 Minimum query *1 Set, Source, value *1 Query, Source *1	Brightness. Range : "4" "E"-"B" "2" Default : "8" "0" ss - reference by Input main select(0x98)
Contrast control - all channels	0x82, "a" "A", nn "+" "-" "r" "R" "?" "m" "n" "i", ss, nn "o", ss,	Set all contrast = value/increment/decrement Reset Query Maximum query *1 Minimum query *1 Set, Source, value *1 Query, Source *1	Contrast Range : "1" "C"-"E" "4" Default : "8" "0" ss - reference by Input main select(0x98)
Saturation control	0x83, nn "+" "-" "r" "R" "?" "m" "n" "i", ss, nn "o", ss,	Set color = value/increment/decrement Reset Query Maximum query *1 Minimum query *1 Set, Source, value *1 Query, Source *1	PAL/NTSC color (In video mode only) Range : "0" "1"-"F" "F" Default : "8" "0" ss - reference by Input main select(0x98)
Hue control	0x84, nn "+" "-" "r" "R" "?" "m" "n" "i", ss, nn "o", ss,	Set tint = value/increment/decrement Reset Query Maximum query *1 Minimum query *1 Set, Source, value *1 Query, Source *1	NTSC tint (In NTSC mode only) Range : "0" "1"-"F" "F" Default : "8" "0" ss - reference by Input main select(0x98)
Phase (tuning) control	0x85, nn "+" "-" "?"	Set dot clock phase = value/increment/decrement Query	Dot clock phase. (In PC mode only)
Image H position	0x86, nnnn "+" "-" "?"	Set img_hpos = value/increment/decrement Query	Image horizontal position. (In PC mode only)
Image V position	0x87, nnnn "+" "-" "?"	Set img_vpos = value/increment/decrement Query	Image vertical position. (In PC mode only)
Sharpness	0x8a, nn "+" "-" "r" "R" "?"	Set sharpness = value/increment/decrement Reset Query	Sharpness. (Video Mode Source only) Default : "0" "C"
Frequency	0x8b, nnnn "+" "-"	Set frequency = Value/increment/decrement	Graphic mode H active size (in pixels)

Specifications subject to change without notice

	"?"	Query	
Scaling Mode	0x8c, "0" "1" "2" "3" "9" "A" "B" "C" "D" "r" "R" "?"	Set graphic image scaling mode = value Reset Query	Image expansion on/off. "0" – 1:1 "1" – fill screen "2" – fill to aspect ratio "9" – 4:3 "A" – 16:9 "B" – 16:10 "C" – 2.35:1 "D" – 2:1
Set display orientation	0x8e, n "r" "R" "?"	Set display orientation = value/increment/decrement Reset Query	"0" – Normal. "1" – Vertical Flip. "2" – Horizontal Flip. "3" – Rotate.
OSD H position	0x90, nnn "+" "-" "r" "R" "?"	Set osd_hpos = value/increment/decrement Reset Query	OSD horizontal position.
OSD V position	0x91, nnn "+" "-" "r" "R" "?"	Set osd_vpos = value/increment/decrement Reset Query	OSD vertical position.
OSD menu timeout	0x93, nn "+" "-" "r" "R" "?"	Select menu timeout = value/increment/decrement Reset Query	OSD menu timeout value. "0""0" – Continuous. value – Round up to nearest available step. if value > max available step, set it to the max available step.
Select OSD language	0x95, n "r" "R" "?"	Select language = English, Chinese,... Reset Query	"0" – English. "2" - French "3" – Spanish "6" - German "8" – Chinese
Input main select	0x98, nn "+" "-" "r" "R" "?"	Select input main = PC or VIDEO or next available Reset Query	Main selected. "0x41,0x31" ARGB "0x44,0x31" HD/SD Component "0x46,0x31" DVI "0x48,0x31" HDMI "0x50, 0x31" Display Port
Auto Source Seek	0x99, nn , "0" "1" "?" "o"	Set Auto source enable = *1 Source Disable/ Enable Query Valid Source query	"nn" = "0x41,0x31"- ARGB "0x44,0x31"- HD/SD Component "0x46,0x31"- DVI "0x48,0x31" HDMI "0x50, 0x31" Display Port
Source Layout	0x9a, n "r" "R" "?"	Select source layout = Single, PIP, PBP, PBPT Reset, Query	Query: "0"- Single "1"- Picture in Picture (PIP) "2"- Picture by Picture (PBP) "3"- Picture by Picture Tall (PBPT) "F" – Turn ON PIP Window ***
Gamma value select (Effective on V1.22.00.00 or later firmware revision)	0x9d, n "r" "R" "?"	Select GAMMA value = Value Reset Query	GAMMA value: "0" – 1.0, "1" – 1.6 "2" – 2.2, "4" – 1.7, "5" – 1.8, "6" – 1.9, "7" – 2.0, "8" – 2.1, "9" – 2.3, "A" – 2.4, "B" – 2.5, "C" – 2.6, "D" – 0.6, "E" – 0.7,

			"F" – 0.8, "G" – 0.9, "H" – 1.1, "I" – 1.2, "J" – 1.3, "K" – 1.4, "L" – 1.5
Auto power off	0x9f, "0" "1" "r" "R" "?"	Set power down option = On/Off Reset Query	"0" – Off. "1" – On.
Hotkey 1	0xa0, "1", n "r" "R" "?"	Set Hotkey 1= Value Reset Query	"2" – brightness.(Default) "3" – contrast. "4" – colour. "5" – input source. "7" – zoom "8" – freeze "9" - PIP "B" – No function "D" - PIP Swap "E" – Aspect Ratio "G" – Hue "H" – Backlight "I" – Auto Picture Setup "K" - PIP ON/OFF
Hotkey 2	0xa0, "2", n "r" "R" "?"	Set Hotkey 2 = value Reset Query	"2" – brightness. "3" – contrast. (Default) "4" – colour. "5" – input source. "7" – zoom "8" – freeze "9" - PIP "B" – No function "D" - PIP Swap "E" – Aspect Ratio "G" – Hue "H" – Backlight "I" – Auto Picture Setup "K" - PIP ON/OFF
Runtime counter	0xa1, nnnnn "r" "R" "?"	runtime counter value = nnnnn (* 0.5 hour) Reset Query	Runtime = nnnnn.
PIP H position	0xa4, nnn "+" "-" "r" "R" "?"	Set PIP_hpos = value/increment/decrement Reset Query	PIP window horizontal position. "0""0""0" ~"0""6""4" Default : "0""5""5"
PIP V position	0xa5, nnn "+" "-" "r" "R" "?"	Set PIP_vpos = value/increment/decrement Reset Query	PIP window vertical position. "0""0""0" ~"0""6""4" Default : "0""1""4"
PIP window size select	0xa6, nn "r" "R" "?"	Select PIP window size = PIP window size value Reset Query	Main selected. PIP off if "nn" = "0""0". "0""0" ~"1""2" "0""0" ~ "1""2" "1""9" : Size by Size "1""A" : Size by Size Tall
PIP source select	0xa7, n "r" "R" "?"	Select input main = Video source value Reset Query	Main selected. 0x40 0x30 : PIP OFF "0x41,0x31"- ARGB "0x44,0x31"- HD/SD Component "0x46,0x31"- DVI "0x48,0x31" HDMI "0x50, 0x31" Display Port
Zoom level	0xa8,	Set Zoom level =	Zoom level.

	nnnn "+" "-" "r" "R" "?"	value/increment/decrement Reset Query	
Zoom H position	0xa9, nnnn "+" "-" "r" "R" "?"	Set Zoom_hpos = value/increment/decrement Reset Query	Zoom window horizontal position. Default : 0x30 0x30 0x30 0x30 The min and max values will change depends on input resolution.
Zoom V position	0xaa, nnnn "+" "-" "r" "R" "?"	Set Zoom_vpos = value/increment/decrement Reset Query	Zoom window vertical position. Default : 0x30 0x30 0x30 0x30 The min and max values will change depends on input resolution.
Colour temperature select	0xb3, n "r" "R" "?"	Select colour temperature = value Reset Query	Main selected. "0" – 9300K. "1" – 8000K.(Default) "2" – 6500K. "3" – 5000K "4" - User
Red level for selected colour temperature	0xb4, nn "+" "-" "r" "R" "?" "m" "n" "i", ss, c, nn "o", ss, c	Set the level of the red channel for the selected colour temp. = value/increment/decrement Reset Query Maximum query *1 Minimum query *1 Set, Source, Temperature Group, value *1 Query, Source *1	Red level for selected colour temperature. Range : "9" "C" - "F" "F" Default : "E" "3" for 8000K c – reference by Color Temperature ss - reference by Input main select(0x98)
Green level for selected colour temperature	0xb5, nn "+" "-" "r" "R" "?" "m" "n" "i", ss, c, nn "o", ss, c	Set the level of the green channel for the selected colour temp. = value/increment/decrement Reset Query Maximum query *1 Minimum query *1 Set, Source, Temperature Group, value *1 Query, Source *1	Green level for selected colour temperature Range : "9" "C" - "F" "F" Default : "E" "3" for 8000K c – reference by Color Temperature ss - reference by Input main select(0x98).
Blue level for selected colour temperature	0xb6, nn "+" "-" "r" "R" "?" "m" "n" "i", ss, c, nn "o", ss, c	Set the level of the blue channel for the selected colour temp. = value/increment/decrement Reset Query Maximum query *1 Minimum query *1 Set, Source, Temperature Group, value *1 Query, Source *1	Blue level for selected colour temperature. Range : "9" "C" - "F" "F" Default : "E" "3" for 8000K c – reference by Color Temperature ss - reference by Input main select(0x98).
Graphic horizontal resolution enquiry	0xb7	Horizontal resolution (in pixels) in 3 digit hex number	"nnn" = horizontal resolution
Graphic vertical resolution enquiry	0xb8	Vertical resolution (in lines) in 3 digit hex number	"nnn" = vertical resolution
Graphic horizontal sync frequency enquiry	0xb9	Horizontal sync frequency (in units of 100Hz) in 3 digit hex number	"nnn" = horizontal frequency
Graphic vertical sync frequency enquiry	0xba	Vertical sync frequency (in units of Hz) in 3 digit hex number and 1 char	"nnnn" = vertical frequency nnn = 3 digit hex c= "i" or "p"

Specifications subject to change without notice

			interlace or Progressive 0xba added the interlace(i) or Progressive(p) feedback.
OSD status enquiry	0xbb	Status of OSD	"0" – OSD turned off "1" – OSD turned on
Display Video Source Select	0xbc, "?" "0" "1"	Display Video source select Query Name of video source not displayed. After switching to a new video source, the name of the video source is displayed for 5 seconds.	"0" – Disabled. "1" – Enabled.
OSD turn off	0xbd	Turn off the OSD.	"0" – fail. "1" – successful.
Query External Memory	0xcb, "2"	Check External Memory 24c256	"0" – Not Installed "1" – Installed "?" – Not Support
Query Revision Number	0xcb, "3"	Read Revision Number	"nn" = Revision number
Backlight control	0xe0, nn "+" "-" "=" "R" "r" "?"	Set Backlight = value/increment/decrement Display OSD indicator Reset Query	Backlight. Range: D/A : "0"0" ~ "5"2" 100Hz : "0"0" ~ "8"3" 120Hz : "0"0" ~ "6"D" 140Hz : "0"0" ~ "5"D" 160Hz : "0"0" ~ "5"2" 180Hz : "0"0" ~ "4"8" 200Hz : "0"0" ~ "4"2" 220Hz : "0"0" ~ "3"B" 240Hz : "0"0" ~ "3"6" 260Hz : "0"0" ~ "3"2" 280Hz : "0"0" ~ "2"E" 300Hz : "0"0" ~ "2"B" 320Hz : "0"0" ~ "2"8" 340Hz : "0"0" ~ "2"6" 360Hz : "0"0" ~ "2"4" 380Hz : "0"0" ~ "2"2" 400Hz : "0"0" ~ "2"0" 420Hz : "0"0" ~ "1"E" 440Hz : "0"0" ~ "1"D"
Backlight On/Off	0xe1, "0" "1" "R" "r" "?"	Backlight Off / Backlight On /Status	"0" – Backlight Off "1" – Backlight On.(Default) "?" – Backlight On/Off Query
Backlight D/A / PWM	0xe5 "0" "1" "R" "r" "?"	Set : PWM or D/A Reset Query	"0" – PWM "1" – D/A (Default)
Monochrome mode (Output Channel Select) (Effective on V1.22.00.00 or later firmware revision)	0xe2 "0" "1" "2" "3" "4" "5" "6" "R" "r" "?"	Off/ Blue Only/ Red Only/ Green Only/ Blue Mono/ Red Mono/ Green Mono/	"0" – Off "1" – Blue Only "2" – Red Only "3" – Green Only "4" – Blue Mono "5" – Red Mono "6" – Green Mono
Backlight PWM Frequency	0xe6, nnn "+" "-" "R" "r"	Set Backlight PWM Frequency = value/increment/decrement Reset	+/- 20Hz Value 100Hz : "0","6","4"

	"?"	Query	120Hz : "0","7","8" 140Hz : "0","8","C" 160Hz : "0","A","0" (Default) 180Hz : "0","B","4" 200Hz : "0","C","8" 220Hz : "0","D","8" 240Hz : "0","F","0" 260Hz : "1","0","4" 280Hz : "1","1","8" 300Hz : "1","2","C" 320Hz : "1","4","0" 340Hz : "1","5","4" 360Hz : "1","6","8" 380Hz : "1","7","C" 400Hz : "1","9","0" 420Hz : "1","A","4" 440Hz : "1","B","8"
Backlight Invert	0xe7 "0" "1" "R" "r" "?"	Set On or Off Reset Query	"0" – Off "1" – On
Red Offset for selected colour temperature	0xe8, nn "+" "-" "r" "R" "?" "m" "n" "i", ss, c, nn "o", ss, c	Set the Offset of the red channel for the selected colour temp. = value/increment/decrement Reset Query Maximum query *1 Minimum query *1 Set, Source, Temperature Group, value *1 Query, Source *1	Red Offset for selected colour temperature. Range : "8""0"- "7""F" Default : "0""0" c – reference by Color Temperature ss - reference by Input main select(0x98)
Green Offset for selected colour temperature	0xe9, nn "+" "-" "r" "R" "?" "m" "n" "i", ss, c, nn "o", ss, c	Set the Offset of the green channel for the selected colour temp. = value/increment/decrement Reset Query Maximum query *1 Minimum query *1 Set, Source, Temperature Group, value *1 Query, Source *1	Green Offset for selected colour temperature. Range : "8""0"- "7""F" Default : "0""0" c – reference by Color Temperature ss - reference by Input main select(0x98)
Blue Offset for selected colour temperature	0xea, nn "+" "-" "r" "R" "?" "m" "n" "i", ss, c, nn "o", ss, c	Set the Offset of the blue channel for the selected colour temp. = value/increment/decrement Reset Query Maximum query *1 Minimum query *1 Set, Source, Temperature Group, value *1 Query, Source *1	Blue Offset for selected colour temperature. Range : "8""0"- "7""F" Default : "0""0" c – reference by Color Temperature ss - reference by Input main select(0x98)
PIP Window Blend Level	0xed, nn "+" "-" "R" "r" "?"	Select PIP Transparency Level PIP Transparency value Reset Query	PIP Transparency "0"F" = 6.25% "0"E" = 12.5% "0"D" = 18.75% "0"C" = 25% "0"B" = 31.25% "0"A" = 37.5% "0"9" = 43.75% "0"8" = 50% "0"7" = 56.25% "0"6" = 62.5% "0"5" = 68.75% "0"4" = 75% "0"3" = 81.25% "0"2" = 87.5% "0"1" = 93.75% "0"0" = 100%.

Light Detector	"0xee", "0x4A" "0" "1" "R" "r" "?" "S" "s"	Light Detector Off / Light Detector On Light Detector On/Off Query Light Detector Value Query	"0" –Light Detector Off (Default) "1" –Light Detector On. "?" – Light Detector On/Off Query "S" "s" –Light Detector Value Query 0x00~0xFF
Access Programming Mode	"0xee", "0x59" "0" "1" "2" "?"	Cancel Access / Set Access Run Smart ISP programming Query	"0" - Cancel Access "1" - Set next start up to access the programming mode.
Minimum Backlight Value	0xee, "0x5C" nn "+" "-" "R" "r" "?"	Set Minimum Backlight value = value / increment / decrement Reset Query	Minimum Backlight value/ Range : D/A : "0"~"0" ~ "3"~"2" 100Hz : "0"~"0" ~ "3"~"2" 120Hz : "0"~"0" ~ "3"~"2" 140Hz : "0"~"0" ~ "3"~"2" 160Hz : "0"~"0" ~ "3"~"2" 180Hz : "0"~"0" ~ "3"~"2" 200Hz : "0"~"0" ~ "3"~"2" 220Hz : "0"~"0" ~ "3"~"2" 240Hz : "0"~"0" ~ "3"~"2" 260Hz : "0"~"0" ~ "3"~"2" 280Hz : "0"~"0" ~ "3"~"2" 300Hz : "0"~"0" ~ "3"~"2" 320Hz : "0"~"0" ~ "3"~"2" 340Hz : "0"~"0" ~ "3"~"0" 360Hz : "0"~"0" ~ "3"~"0" 380Hz : "0"~"0" ~ "3"~"0" 400Hz : "0"~"0" ~ "3"~"1" 420Hz : "0"~"0" ~ "3"~"1" 440Hz : "0"~"0" ~ "3"~"1"
OSD Switch Mount Lock	"0xee", "0x62" "0" "1" "?"	Unlock / Lock Query	"0" - Unlock "1" - Lock
Anti image retention	"0xee", "0x6C" "E", "1" "0"	Anti image retention On / Off	
Anti image retention Method	"0xee", "0x6C" "M", "0" "1" "2" "3"	Run Anti image retention Method Horizontal Pan Vertical Pan Flash Pixel Shift	
Anti image retention Pixel Shift Manual	"0xee", "0x6C" "P", "H" "V" "nn" "+" "-" "R" "r" "?"	Anti image retention Pixel Shift Manual Horizontal / Vertical Shift value/increment/decrement Reset Query	

3. Other control

Function	Command	Description	Acknowledge (if enabled)
Select RS-232 acknowledge	0xc1, "0" "1"	Disable/enable command acknowledge.	"0" – acknowledge disabled. "1" – acknowledge enabled.
Auto-setup	0xc3	Start auto-setup of current vmode.	"0" – fail. "1" – successful.
Command	0xc4, n	Check whether a command is	"0" – not available.

availability		available.	"1" – available.
Auto-calibration	0xc5	Start auto-calibration of gain of the RGB amplifier.	"0" – fail. "1" – successful.
Freeze frame	0xc6, "0" "1" "="	Unfreeze / freeze frame Display OSD indicator	"0" – unfreeze. "1" – freeze.
Soft Power On/Off	0xc8, "0" "1" "?"	Soft power off/on query	"0" - Soft power off "1" - Soft power on
Query video input status	0xc9	Query the status of the primary & pip status	"nn,nn" = input status "nn,xx" digit = primary status: "0","0" : invalid "A","1" ARGB "D","1" HD/SD Component "F","1" DVI "H" "1" HDMI "P" "1" Display Port
Query BIOS version	0xcb, "0"	Read BIOS version	BIOS version "VV.YY.ZZ" VV = V0 or E0, V0 = Release version E0 = Engineering Sample YY= Version Number ZZ= Customer Number
Query PCBA number	0xcb, "1"	Read PCBA number	"nnnnn" = PCBA number SVX-2560= "41747"
Reset to Factory Defaults	0xce	Reset all parameters to default value	"1" – successful.
Reset to Factory Defaults with (color temp)	0xcf	Reset all parameters for all video modes to default value	"1" - successful.
Saved Calibrated default	0xd7	Saving all parameters to user default value	"1" - successful.
Load Calibrated default	0xd8	Loading all parameters to user default value	"1" - successful. "0" - not successful "E" – Checksum Error
Wide Screen Mode Selection	0xd9, "n""n" "r" "R" "?"	Wide Screen Mode Reset Query	"n,n" = input status "n,x" digit = Group 1 mode select: "0" – 1024x768 (Default) "1" – 1280x768 "2" – 1366x768 "3" - 1360x768 "x,n"= :Group 2 mode select "4" - 1440x900 (Default) "5" - 1600x900

The following commands for sending texts by using RS-232 command. (Effective on V1.16.00.00 firmware or later revision)

Function	Command	Description	Acknowledge (if enabled)
Send Line	0xF0, "S" "LL" "TEXT" "0x0A" Return "1"	"S" = "0x53 or 0x73" Send command ----- "LL" = "0x30,0x31~0x30,0x34" Line number (Rang 0~4 lines) ----- -	"S" – Send Command "LL" – Line Number "Text" – Character "0x0A" – End of Line "1" - successful.

Specifications subject to change without notice

		<p>"Text" = ASCII code, "0x20~0x7E" Character(Rang 0~34) ----- - 0x0A = End of line</p>	
<p>e.g Display "Send Text" message on screen: RS232 Code:"0xF0 0x53 0x30 0x31 0x53 0x65 0x6E 0x64 0x20 0x54 0x65 0x78 0x74 0x0A" Return Code: "0xF0 0x53 0x30 0x31 0x53 0x65 0x6E 0x64 0x20 0x54 0x65 0x78 0x74 0x0A 0x31"</p>			
Clear Line	<p>0xF0, "C" "LL" Return "nn"</p>	<p>"C" = "0x43 or 0x63" Clear command ----- - "LL" = "0x30,0x31~0x30,0x34" Line number (Rang 0~4 lines)</p>	<p>"C" – Clear command "LL" – Line Number "nn" – Return Line number</p>
<p>e.g Clear Line 1 RS232 Code: "0xF0 0x43 0x30 0x31" Return Code: "0xF0 0x43 0x30 0x31 0x30 0x31"</p>			
Text Window Horizontal Position	<p>0xF0, "H" "ss" Return "nn"</p>	<p>"H" = "0x48 or 0x68" ----- --"nn" = "0x30,0x30~0x46,0x46"</p>	<p>"H" – Horizontal Position command "ss" – Set Horizontal Position number "nn" – Return Position number</p>
<p>e.g Set Text Window Horizontal Position RS232 Code: "0xF0 0x48 0x30 0x31" Return Code: "0xF0 0x48 0x30 0x31 0x30 0x31"</p>			
Text Window Vertical Position	<p>0xF0, "V" "ss" Return "nn"</p>	<p>"V" = "0x56 or 0x76" ----- --"nn" = "0x30,0x30~0x46,0x46"</p>	<p>"V" – Vertical Position command "ss" – Set Vertical Position number "nn" – Return Position number</p>
<p>e.g Set Text Window Vertical Position RS232 Code: "0xF0 0x56 0x30 0x31" Return Code: "0xF0 0x56 0x30 0x31 0x30 0x31"</p>			
Left offset	<p>0xF0, "O" "SSS" Return "nnn"</p>	<p>"O" = "0x4F or 0x6F" Set Left Offset command ----- - "SSS" = "0x30,0x30,0x30~ 0x33,0x46,0x46" Offset Value (Rang 000~3ff)</p>	<p>"O" – Left Offset Command "SSS"- Offset Value (pixels) "nnn"- Return Value(pixels)</p>
<p>e.g Set Left Offset = 100 pixels (0x64 (HEX)) RS232 Code: "0xF0 0x4F 0x30 0x36 0x34" Return Code: "0xF0 0x4F 0x30 0x36 0x34 0x30 0x36 0x34"</p>			
Text Window Horizontal Size	<p>0xF0, "X" "SSS" Return "nnn"</p>	<p>"X" = "0x58" Set Horizontal Size command ----- - "SSS" = "0x31,0x45,0x30~ 0x37,0x38,0x30" Horizontal Size Value (Rang 000~3ff)</p>	<p>"X" –Horizontal Size "SSS"- Size Value (pixels) "nnn"- Return Value(pixels)</p>

e.g Set Text Window Horizontal Size = 640 pixels (0x280 (HEX)) RS232 Code: "0xF0 0x58 0x32 0x38 0x30" Return Code: "0xF0 0x58 0x32 0x38 0x30 0x32 0x38 0x30"			
Background Transparency	0xF0, "B" "N" Return "n"	"B" = "0x42 or 0x62" Set Transparency command ----- "N" = "0x30~0x46" Transparency Value (Rang 00~0F)	"B" - Transparency command "N" – Transparency Value "n"- Return Value 0x00 =opaque
Set background Transparency value is 8 RS232 Code: "0xF0 0x42 0x38" Return Code: "0xF0 0x42 0x38 0x38"			
Text Overlay Background On or Off	0xF0, "Q" "N" Return "n"	"Q" = "0x51 or 0x71" Set Background Enable or Disable ----- "N" = "0x30~0x31"	"B" - command "1" Turn On Text Overlay Background "0" Turn Off Text Overlay Background "n"- Return Value
Set background Transparency value is 8 RS232 Code: "0xF0 0x51 0x31" Return Code: "0xF0 0x51 0x31 0x31"			

Please set the "Background Transparency" and "Left offset" commands before the "Send Line" command.

**The RS-232 command strings sent in one time can support up to 380 bytes via CN8 port
The RS-232 command string sent in one time can support up to 50 bytes via CN1 or J1 port.**

**n = 1-byte ascii-coded hex number, e.g., parameter value of 0x1 is represented by "1" (0x31).
mn or nn = 2-byte ascii-coded hex number, e.g., parameter value of 0x1e is represented by "1", "e" | "E"
(0x31, 0x6e|0x4e).**

Please refer to the ASCII to Hex convert table below.

Hex to ASCII conversion table

Hex	ASCII	Hex	ASCII	Hex	ASCII	Hex	ASCII
0x30	0	0x41	A	0x61	a	0x2B	+
0x31	1	0x42	B	0x62	b	0x2D	-
0x32	2	0x43	C	0x63	c	0x3F	?
0x33	3	0x44	D	0x64	d		
0x34	4	0x45	E	0x65	e		
0x35	5	0x46	F	0x66	f		
0x36	6	0x47	G	0x67	g		
0x37	7	0x48	H	0x68	h		
0x38	8	0x49	I	0x69	i		
0x39	9	0x4A	J	0x6A	j		
		0x4B	K	0x6B	k		
		0x4C	L	0x6C	l		
		0x4D	M	0x6D	m		
		0x4E	N	0x6E	n		
		0x4F	O	0x6F	o		
		0x50	P	0x70	p		
		0x51	Q	0x71	q		
		0x52	R	0x72	r		
		0x53	S	0x73	s		
		0x54	T	0x74	t		
		0x55	U	0x75	u		
		0x56	V	0x76	v		
		0x57	W	0x77	w		
		0x58	X	0x78	x		
		0x59	Y	0x79	y		
		0x5A	Z	0x7A	z		

Appendix III – Mapping definition

- Definition of Mapping A :

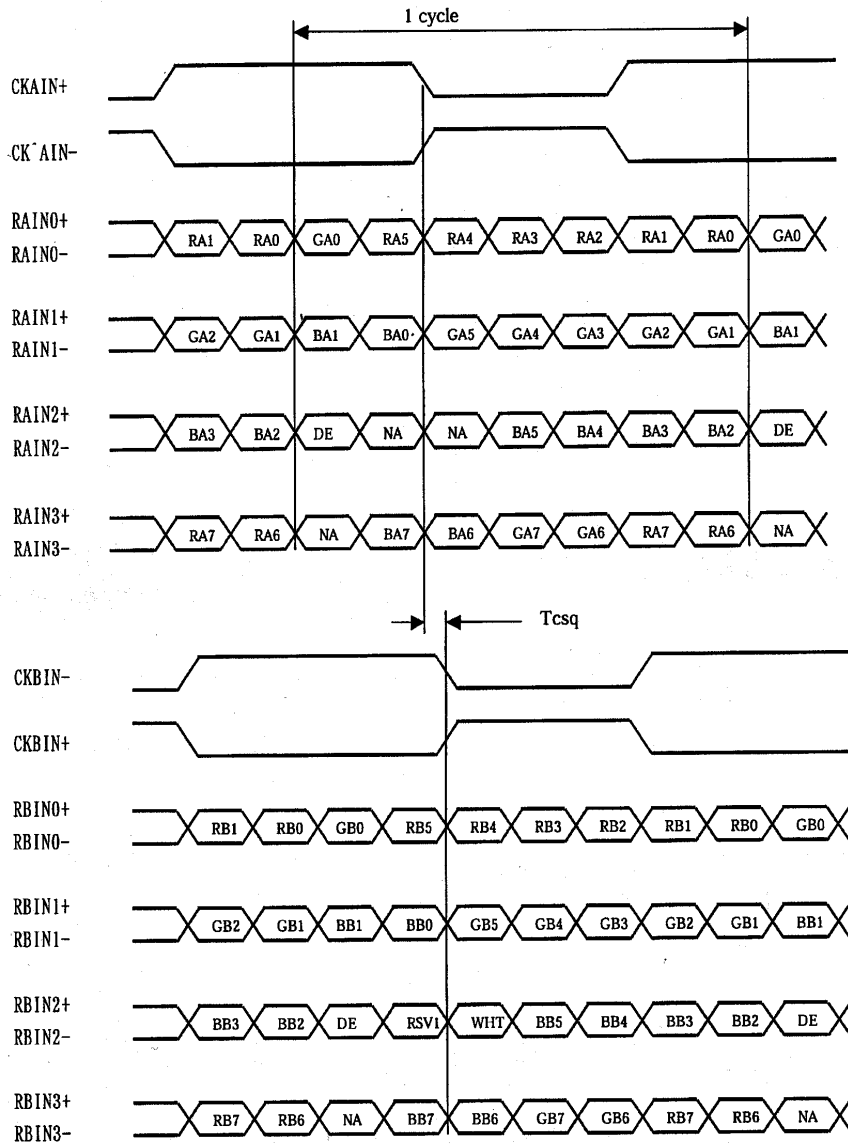

- Definition of Mapping B :

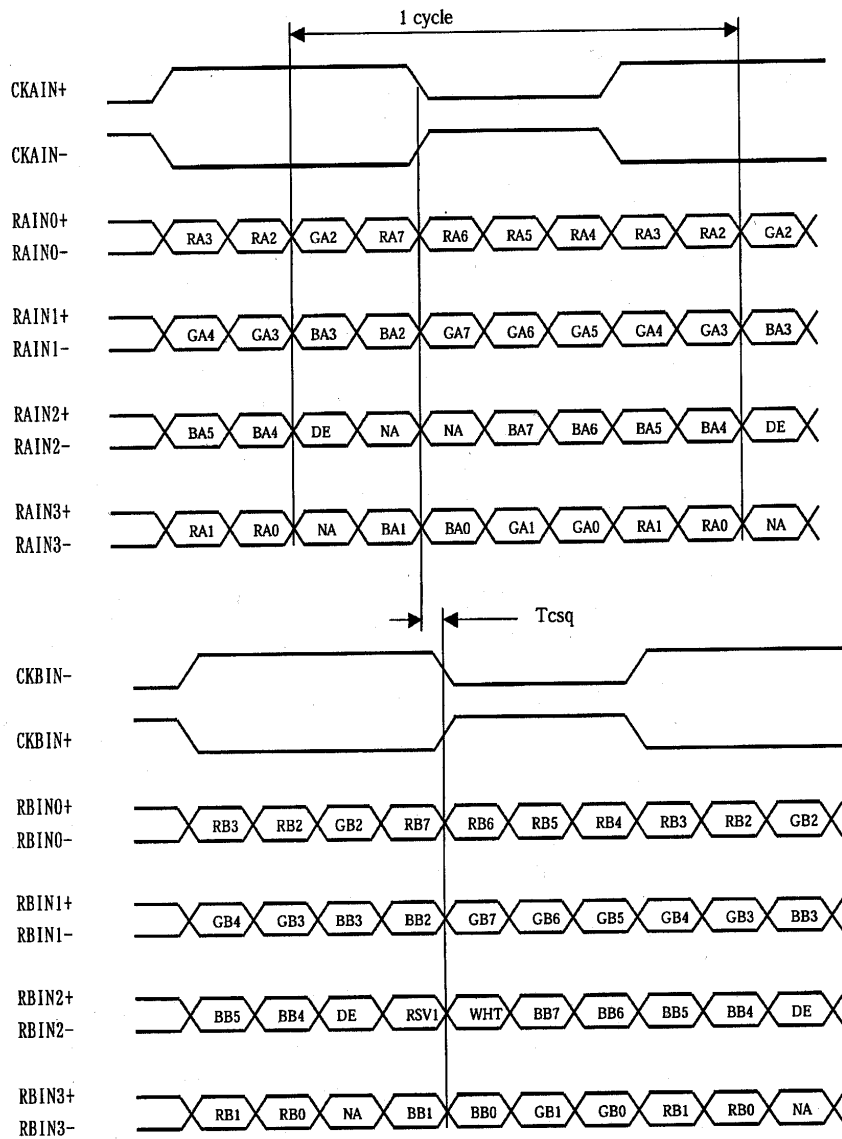

- Definition of VESA :

DPort Output Pair	Bit 6	Bit 5	Bit 4	Bit 3	Bit 2	Bit 1	Bit 0
DB[7:6] / TXDEC							
DB[3:2] / TXDE0	GE0	RE5	RE4	RE3	RE2	RE1	RE0
DB[5:4] / TXDE1	BE1	BE0	GE5	GE4	GE3	GE2	GE1
DB[9:8] / TXDE2	EN	VS	HS	BE5	BE4	BE3	BE2
DG[3:2] / TXDE3	field/prg	BE7	BE6	GE7	GE6	RE7	RE6
DG[5:4] / TXDE4	low	BE9	BE8	GE9	GE8	RE9	RE8
DG[7:6] / TXDO0	GO0	RO5	RO4	RO3	RO2	RO1	RO0
DG[9:8] / TXDO1	BO1	BO0	GO5	GO4	GO3	GO2	GO1
DR[5:4] / TXDO2	EN	VS	HS	BO5	BO4	BO3	BO2
DR[7:6] / TXDO3	field/prg	BO7	BO6	GO7	GO6	RO7	RO6
DR[9:8] / TXDO4	low	BO9	BO8	GO9	GO8	RO9	RO8
DR[3:2] / TXDOC							

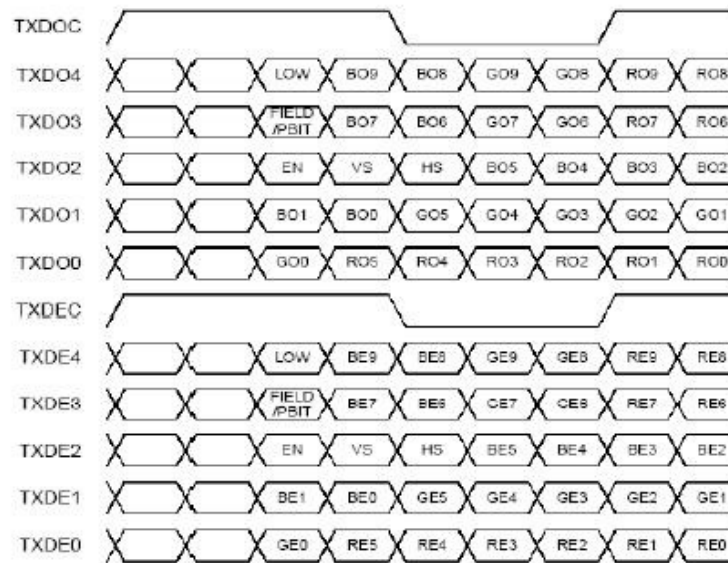

- Definition of JEIDA :

DPort Output Pair	Bit 6	Bit 5	Bit 4	Bit 3	Bit 2	Bit 1	Bit 0
DB[7:6] / TXDEC							
DB[3:2] / TXDE0	GE4	RE9	RE8	RE7	RE6	RE5	RE4
DB[5:4] / TXDE1	BE5	BE4	GE9	GE8	GE7	GE6	GE5
DB[9:8] / TXDE2	EN	VS	HS	BE9	BE8	BE7	BE6
DG[3:2] / TXDE3	field/prg	BE3	BE2	GE3	GE2	RE3	RE2
DG[5:4] / TXDE4	low	BE1	BE0	GE1	GE0	RE1	RE0
DG[7:6] / TXDO0	GO4	RO9	RO8	RO7	RO6	RO5	RO4
DG[9:8] / TXDO1	BO5	BO4	GO9	GO8	GO7	GO6	GO5
DR[5:4] / TXDO2	EN	VS	HS	BO9	BO8	BO7	BO6
DR[7:6] / TXDO3	field/prg	BO3	BO2	GO3	GO2	RO3	RO2
DR[9:8] / TXDO4	low	BO1	BO0	GO1	GO0	RO1	RO0
DR[3:2] / TXDOC							

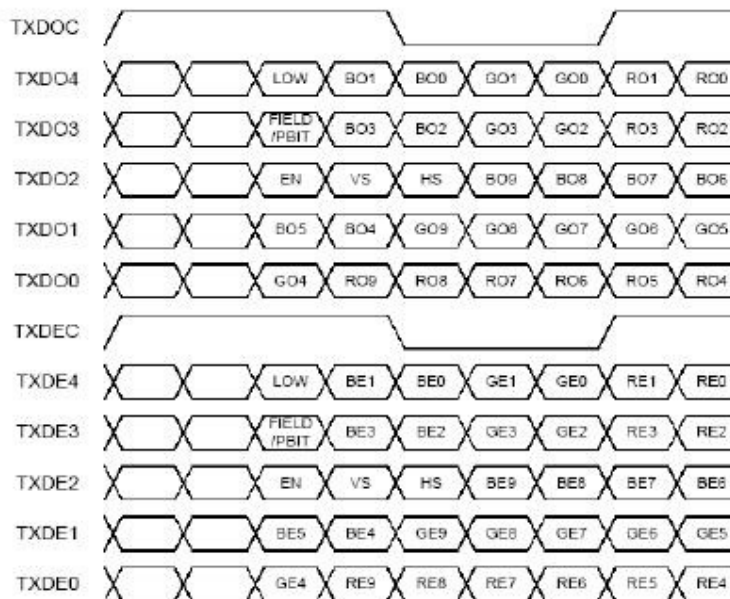

Appendix IV – Auto Color Gain

The Auto Color Gain function is supported in the ARGB mode only and is designed to calibrate the controller to the incoming video signal. In order to calibrate correctly, the display must be displaying an image containing both black and white data (see illustration below) when the function is used. The internal processor of the video controller chip will then execute a process to adjust the relative values of the RGB signals to achieve the best performance. The parameters of the corrected RGB values are then stored in the controller and are unaffected by the Reset Factory Defaults function.

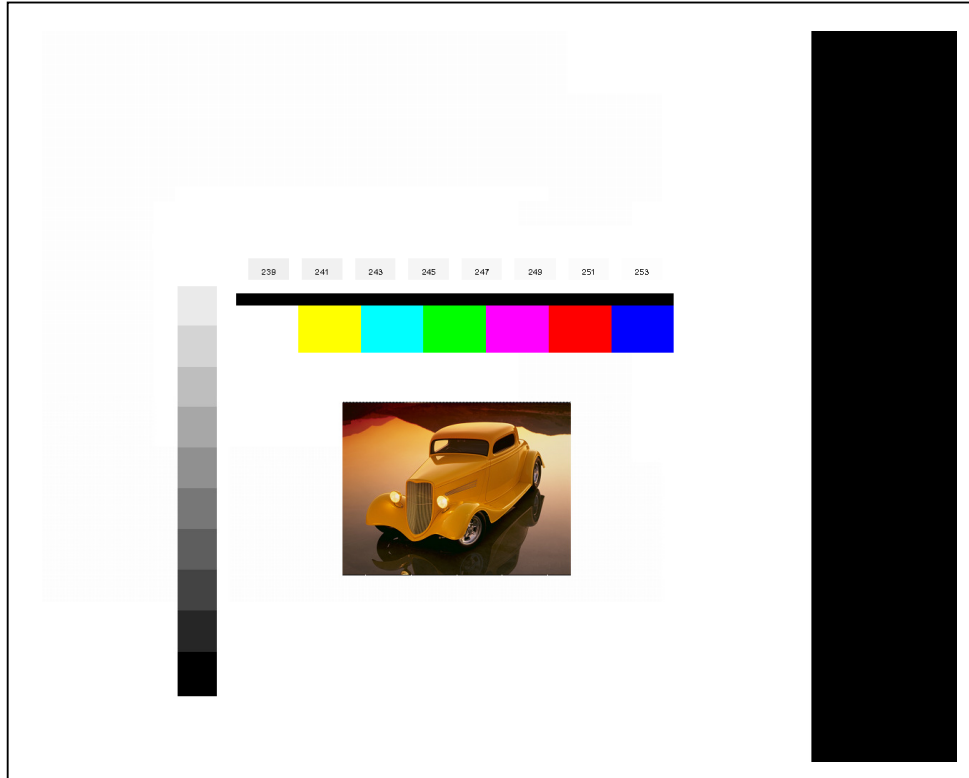

The reference pattern can be downloaded at :
http://www.digitalview.com/support/downloads/TestPattern_1280.BMP

This reference pattern is for 1280x1024 resolution and it needs to set your ARGB input source to 1280x1024 resolution before performing the Auto Color Gain function. The position of the black vertical bar in the pattern at the right side is important. It will affect the calibration result if you are setting the ARGB input to other resolution.

Warning - If the Auto Color Gain is executed without an appropriate image being displayed, then the process will set incorrect values and the display colors will be distorted. If this occurs, then it can either be corrected by performing the process correctly or if this is not possible then the Reset Color Gain function can be used. This function will reset the stored RGB values to a set of approximate values.

Appendix V – DV remote control unit work for SVX-2560

P/N 559000106-3 :
DigitalView remote control unit
(without DV logo silk screen
printing)

P/N 559000105-3 :
DigitalView remote control unit
(with DigitalView logo silk screen
printing)



BUTTON	FUNCTION
POWER BUTTON	Soft power ON/OFF button.
SEL UP (∧) / SEL DN (∨)	Use this button to direct control the hotkey function. Press the "SEL UP" button to increase the pre-set hotkey parameter value and the "SEL DN" button to decrease the pre-set hotkey parameter value. In OSD menu, pressing this button to select the items.
+ / - BUTTON	Use this button to direct control the hotkey function. Press the "+" button to increase the pre-set hotkey parameter value and the "-" button to decrease the pre-set hotkey parameter value. In OSD menu, pressing this button to adjust the settings.
OSD BACK BUTTON	Use to display the OSD menu and go to the previous OSD screen.
OSD NEXT BUTTON	Use to display the OSD menu and go to the next OSD screen.
DISPLAY BUTTON	Use to view an on-screen information. When OSD menu displayed, press this button to turn it off.
AV/TV BUTTON	Use to select the input source. (VGA/DVI/HDMI/..)
SOUND (ZOOM) BUTTON	Use to display the zoom menu. Press the "+" to zoom in the picture and the "-" to zoom out the picture.
PLAY (YPbPr) BUTTON	Press this button in the non OSD menu display mode to select Component 1 source.
STOP (VGA) BUTTON	Press this button in the non OSD menu display mode to select VGA source.
DVI BUTTON	Press this button in the non OSD menu display mode to select DVI source.
HDMI BUTTON	Press this button in the non OSD menu display mode to select HDMI source.

Appendix VI – PIP mix table

PIP \ MAIN	VGA (P1)	DVI (P2/CN2)	HDMI (P3/CN5)	Display Port (P4)	Component (CNV2)
VGA (P1)	X	✓	✓	✓	X
DVI (P2/CN2)	✓	X	X	✓	✓
HDMI (P3/CN5)	✓	X	X	✓	✓
Display Port (P4)	✓	✓	✓	X	✓
Component (CNV2)	X	✓	✓	✓	X

Appendix VII – Network connection

The SVX-2560 LCD interface controller has an RJ-45 Ethernet port for control and monitoring over a network. This application note introduces the two user interface modes:

- Command line direct mode
- Browser based web server mode

There is also a short overview of the command set and how it is implemented.

QUICK GUIDE

For experienced users the following quick guide to trying out the network connection and functions may be useful.

Command line direct mode: The SVX-2560 ships with the command line direct mode installed as default. This is relevant when a PC application is used to send and receive commands over the network port.

Browser based web server mode : The network port will require an alternative firmware version if the browser based web server mode is required.

- Works with a normal network with DHCP, i.e. must use a router.
- Connect the SVX-2560 to the network and ensure power is on.
- Use the IP Locator utility available from the IP-60 web-page.
<http://www.digitalview.com/media/downloads/IPLocator.zip> (Windows only)
- Double click on the IP address in the IP Locator window, it will open the SVX-2560 browser page in your default browser. Alternatively copy the IP address into your browser address line.
- Test the functions that come up on the browser.

For details, please refer to the separate application note.

Appendix VIII – Audio Support

SVX-2560 added support the external audio board & enable the SPDIF function start from V1.22.00.00 firmware version. A new OSD menu item under "Utilities" > "Audio Output" for the user to select audio input & output selection as shown below :

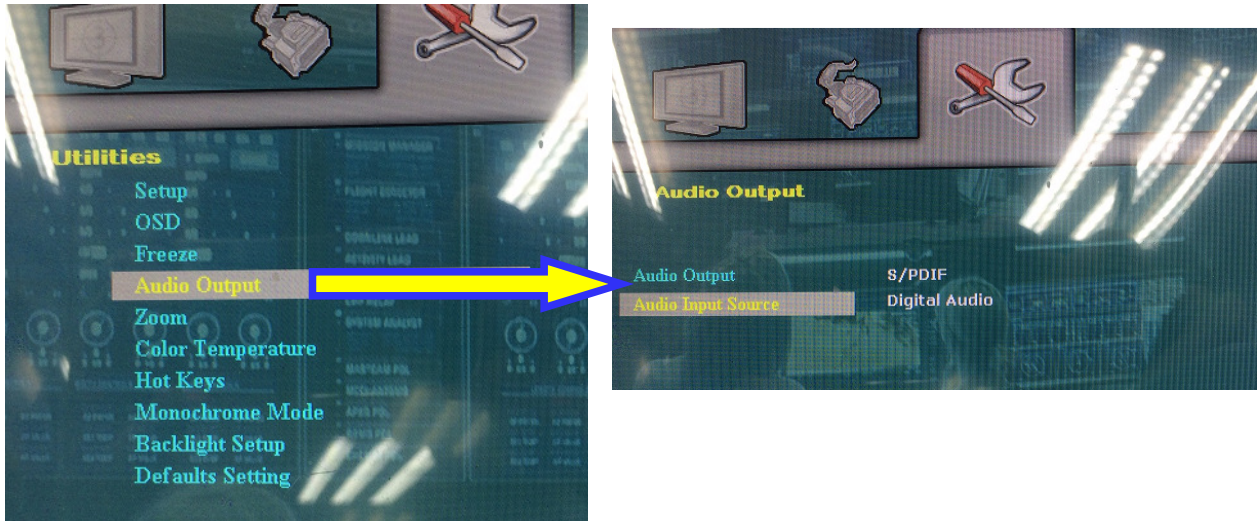

Three combination audio input and output settings available :

Option	Audio Input	Audio Output	Audio input and output setting on the OSD menu page (under Utilities > Audio Output)
1	From HDMI connector (P3 / CN5) or Display Port connector (P4)	CN14 connector for Analog (Stereo) audio output)	Audio Output = Analog Audio Audio Input source = Digital Audio
2		CN11 connector for SPDIF output	Audio Output = S/PDIF Audio Input source = Digital Audio
3	From Line in connector (CN2/J2) on external audio add on board P/N 416940020-3.	CN1 / J1 on external audio add on board P/N 416940020-3	Audio Output = Analog Audio Audio Input source = Line in

Example for Option 1 : If you want to get the digital audio input from HDMI and Stereo audio output (via CN14) and connect to audio add on board P/N 416940020-3 on CN2 connector via the audio extend cable P/N 426451800-3, you need to set "Audio Output" = "Analog Audio" and "Audio Input Source" = "Digital Audio" as shown in photo A.

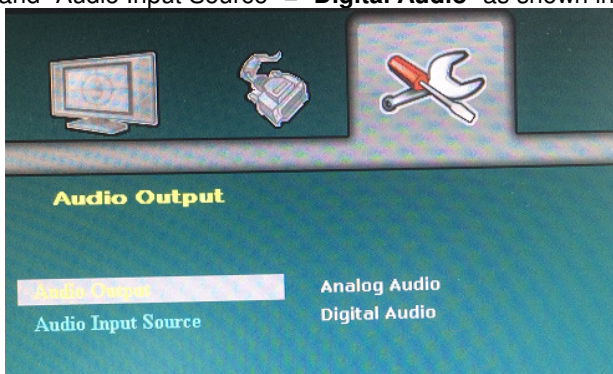
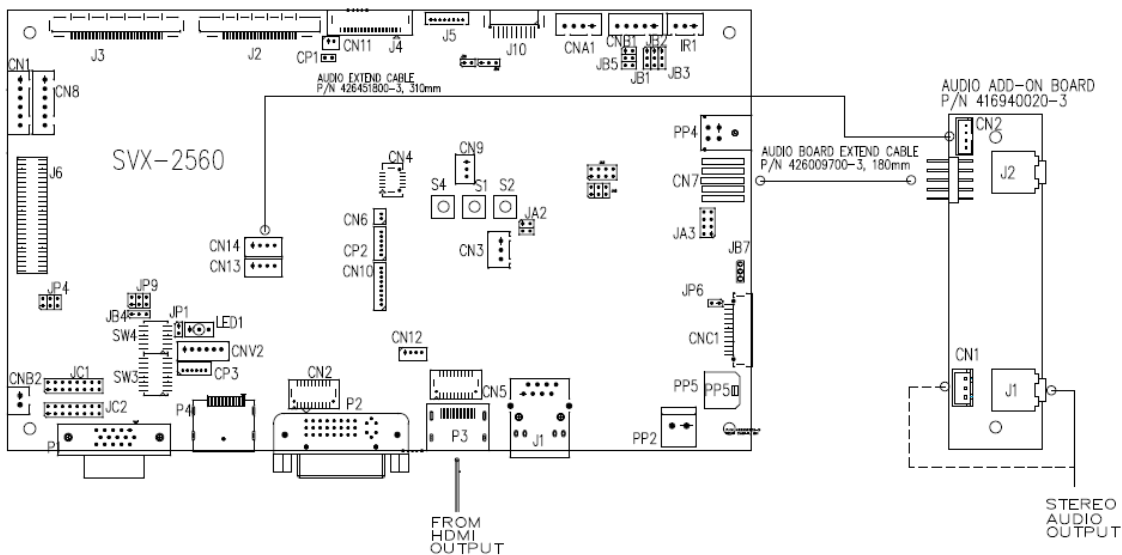

Photo A

System connection diagram showing the connection between SVX-2560 and the Audio add-on board :



Example for Option 2 : If you want to get the digital audio input from HDMI and SPDIF output (via CN11), you need to set "Audio Output" = "SPDIF" and "Audio Input Source" = "Digital Audio" as shown in photo B.

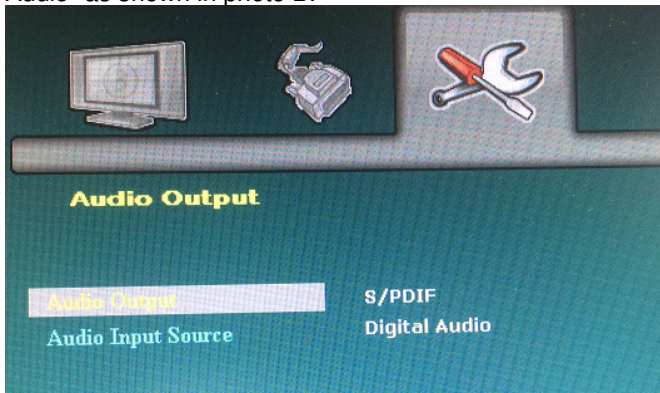

Photo B

Example for Option 3 : If you want to get the audio input from Line In connector (CN2/J2) on external audio add on board P/N 416940020-3 and audio output via CN1 / J1 on external audio add on board P/N 416940020-3, you need to set "Audio Output" = "Analog Audio" and "Audio Input Source" = "Line In" as shown in photo C.

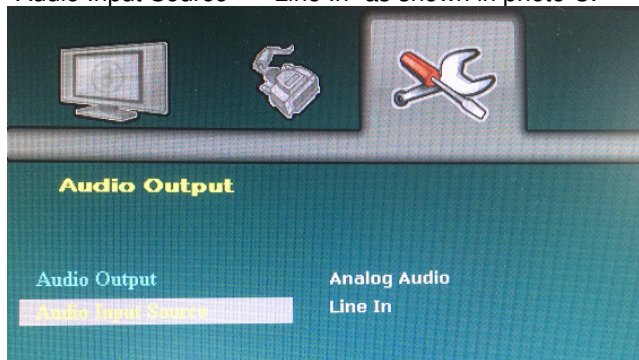

Photo C

The sound level can be controlled under "Volume" function in OSD menu page under "Picture" > "Volume".



Use "Volume" function to control the sound level.

WARRANTY

The products are warranted against defects in workmanship and material for a period of three (3) year from the date of purchase provided no modifications are made to it and it is operated under normal conditions and in compliance with the instruction manual.

The warranty does not apply to:

- Product that has been installed incorrectly, this specifically includes but is not limited to cases where electrical short circuit is caused.
- Product that has been altered or repaired except by the manufacturer (or with the manufacturer's consent).
- Product that has subjected to misuse, accidents, abuse, negligence or unusual stress whether physical or electrical.
- Ordinary wear and tear.

Except for the above express warranties, the manufacturer disclaims all warranties on products furnished hereunder, including all implied warranties of merchantability and fitness for a particular application or purpose. The stated express warranties are in lieu of all obligations or liabilities on the part of the manufacturer for damages, including but not limited to special, indirect consequential damages arising out of or in connection with the use of or performance of the products.

CAUTION

Whilst care has been taken to provide as much detail as possible for use of this product it cannot be relied upon as an exhaustive source of information. This product is for use by suitably qualified persons who understand the nature of the work they are doing and are able to take suitable precautions and design and produce a product that is safe and meets regulatory requirements.

LIMITATION OF LIABILITY

The manufacturer's liability for damages to customer or others resulting from the use of any product supplied hereunder shall in no event exceed the purchase price of said product.

TRADEMARKS

The following are trademarks of Digital View Ltd:

- Digital View
- SVX-2560

CONTACT DETAILS

Digital View has offices in Asia, Europe and USA :

USA

Digital View Inc.
18440 Technology Drive
Building 130
Morgan Hill,
California, 95037
USA

Tel: (1) 408-782 7773 **Fax:** (1) 408-782 7883

Sales: ussales@digitalview.com

EUROPE

Digital View Ltd.
The Lake House
Knebworth Park
Herts, SG3 6PY
UK

Tel: +44-(0)20-7631-2150 **Fax:** +44-(0)20-7631-2156

Sales: uksales@digitalview.com

ASIA

Digital View Ltd
2nd Floor Bamboos Center
52 Hung To Road
Kwun Tong
Hong Kong

Tel: (852) 2861 3615 **Fax:** (852) 2520 2987

Sales: hksales@digitalview.com

WEBSITE

www.digitalview.com

Revision History

Date	Rev No.	Page	Summary
9 Dec 2014	1.00	All	First issued
13 March 2014	2.00	All	Features added for up to P/N 417470022-3 version.
29 Jan 2016	3.00	11 14 18-19 22 29 37 43-45	- Add "Image Orientation" function on OSD menu page. - Correct typo in the "Connector" table for CN2 - JST BM20B-SRDS Add the definition of SW3 position 8 for video lock function. - Correct typo for the definition of CNV2 pin 3 is Pb and pin 4 is Pr - Add a statement - "Found "Loading" message displayed on screen message...." under Trouble Shooting > Image appearance section. - Add "Image Orientation" RS-232 command (0x8e). - Add text overlay function RS-232 commands.
13 April 2016	3.01	15, 23 23 24 25 32	- Add OP1-4 description on JC2 jumper. - Add OP1-4 description on J2 (pin 16-19) connector - Add pin assignment on J4 connector - Add pin assignment on J6 connector - Add "Use of memory on board" section in the specification table.
26 Aug 2016	3.02	1, 4 3, 14, 17, 28 11, 39 13 18 19 25 26 42 11, 12 & 57-58	- Add "1920x1080(120Hz)" panel support. - Update the SVX-2560 diagram by adding J10 connector. - Added Standard Gamma Selection (0.6 ~ 2.6) support on OSD menu and RS-232 command. - Add "Monochrome Mode" support in OSD menu. - Add new two panel support - Samsung ASI545FB01-0 and Hitachi TX48D02VM0BAA - Add support "Resolution default by EDID" for different resolution panel function description. - Add pin assignment of J10. - Revised pin assignment of P2 - Add RS-232 command for "Monochrome Mode". - Add support the external audio board & enable the SPDIF function.