

Subject to changes. Please also observe the further product documentation!

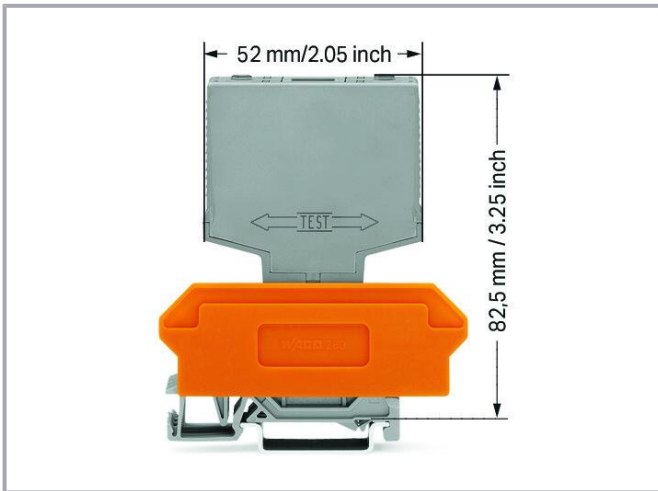

Data

Technical data

Control Circuit

Nominal input voltage U_N	DC 5 V
Input voltage range (high level)	DC 2 ... 6.25 V
Nominal input current at U_N	14 mA
Input current range	3.3 ... 18.5 mA

Load circuit

Circuit type	3-wire connection High-side switching
Limiting continuous current	0.5 A
Nominal output voltage	DC 24 V
Output voltage range	DC 20 ... 30 V
Voltage drop at output (max.)	\leq DC 1.2 V
Leakage current at rated voltage	\leq 2 μ A
Output closed-circuit current (without load) max.	12 mA
Turn-on time	\leq 5 μ s
Turn-off time	\leq 10 μ s
Switching frequency	\leq 25 kHz

Subject to changes. Please also observe the further product documentation!

WAGO GmbH & Co. KG
 Hansastr. 27
 32423 Minden
 Phone: +49571 887-0 | Fax: +49571 887-169
 Email: info.de@wago.com | Web: www.wago.com

Do you have any questions about our products?
 We are always happy to take your call at +49 (571) 887-44222.



Signaling

Status indicator	Red LED
------------------	---------

Safety and protection

Pollution degree	2
Dielectric strength (control/load circuit) (AC, 1 min)	2.5 kVrms
Protection type	IP20

Physical data

Width	15 mm / 0.591 inches
Height from upper-edge of DIN-rail	82.5 mm / 3.25 inches
Depth	52 mm / 2.047 inches

Mechanical data

Mounting type	Pluggable module for receptacle terminal blocks
---------------	---

Material Data

Color	gray
Fire load	0.345 MJ
Weight	18.5 g

Environmental requirements

Ambient temperature (operation at U_N)	-25 ... +70 °C
Ambient temperature (storage)	-25 ... +70 °C
Processing temperature	-25 ... +50 °C
Relative humidity	5 ... 95 % (no condensation permissible)
Operating altitude (max.)	2000 m

Standards and specifications

Standards/specifications	EN 60664-1
--------------------------	------------

Commercial data

Product Group	6 (INTERFACE ELECTRONIC)
eCl@ss 10.0	27-26-15-03

Subject to changes. Please also observe the further product documentation!



eCl@ss 9.0	27-26-15-03
ETIM 8.0	EC001504
ETIM 7.0	EC001504
PU (SPU)	15 (1) pcs
Packaging type	Box
Country of origin	DE
GTIN	4050821371472
Customs tariff number	85365005000

Environmental Product Compliance

CAS-No.	1303-86-2 1317-36-8 7439-92-1 79-94-7
REACH Candidate List Substance	2,2',6,6'-tetrabromo-4,4'-isopropylidenediphenol Diboron trioxide Lead Lead monoxide
RoHS Compliance Status	Compliant,With Exemption
RoHS Exemption	7(a) 7(c)-I 7(c)-II
SCIP notification number (Austria)	68e34822-36f2-4948-a65d-16e3d45d364e
SCIP notification number (Belgium)	b3006504-4d49-40b4-b532-740bb109c44b
SCIP notification number (Bulgaria)	1c579c18-a6ef-4181-a797-7fc65e5c3664
SCIP notification number (Czech Republic)	3067aa91-ae5b-40ca-ac83-4d79c0d55ab0
SCIP notification number (Denmark)	a2dd751e-4fbc-43f4-bc44-fcd81cf5fb6f
SCIP notification number (Finland)	ad6122b9-3b84-481b-9977-6371561b1bb4
SCIP notification number (France)	999c9e14-32a8-4127-8f43-e8d40c8f7e17
SCIP notification number (Germany)	3ce654cb-5e17-4704-a556-935685747743
SCIP notification number (Hungary)	c0ea2a27-030c-49d3-8785-be72b39c7689
SCIP notification number (Italy)	11e4396c-6252-4584-8297-dc1da7ce4d63
SCIP notification number (Netherlands)	33e9aca1-7dce-4743-bc9c-877096c019cc
SCIP notification number (Poland)	1635e163-9836-451c-9143-f88e18df4a25
SCIP notification number (Romania)	dbde4405-0c0e-4113-9e27-eba997162789
SCIP notification number (Sweden)	ba227818-1544-4152-98b7-a8fb927aa3cd

Approvals / Certificates

General approvals

Subject to changes. Please also observe the further product documentation!

WAGO GmbH & Co. KG
Hansastr. 27
32423 Minden
Phone: +49571 887-0 | Fax: +49571 887-169
Email: info.de@wago.com | Web: www.wago.com

Do you have any questions about our products?
We are always happy to take your call at +49 (571) 887-44222.



Logo	Approval	Additional Approval Text	Certificate name
	EAC Brjansker Zertifizierungsstelle	TP TC 020/2011	EAC_Certificate_RU_C-DE.AM02.B.00115_19

Optional accessories

Marking accessories

Marker			
	Item no.: 209-701 WSB marking card; as card; not stretchable; plain; snap-on type; white		www.wago.com/209-701

Terminal blocks

Terminal block for pluggable modules			
	Item no.: 280-619 Terminal block for pluggable modules; 6-pole; with 2-conductor terminal blocks; with orange separator; www.wago.com/280-619 for DIN-rail 35 x 15 and 35 x 7.5; 2.5 mm ² ; CAGE CLAMP®; 2,50 mm ² ; gray		
	Item no.: 280-609 Terminal block for pluggable modules; 6-pole; with 4-conductor terminal blocks; with orange separator; www.wago.com/280-609 for DIN-rail 35 x 15 and 35 x 7.5; 2.5 mm ² ; CAGE CLAMP®; 2,50 mm ² ; gray		
	Item no.: 280-763 Terminal block for pluggable modules; 6-pole; with 4-conductor terminal blocks; with marker carrier; www.wago.com/280-763 with orange separator; for DIN-rail 35 x 15 and 35 x 7.5; 2.5 mm ² ; CAGE CLAMP®; 2,50 mm ² ; gray		www.wago.com/280-763

Downloads

Documentation

Bid Text

286-752/002-000 docx - Datei	2019 Feb 20	docx 15.7 kB	Download
286-752/002-000 X81 - Datei	2019 Feb 19	xml 3.9 kB	Download

Instruction Leaflet

		pdf 1.3 MB	Download
--	--	---------------	----------

Additional Information

Disposal and Recycling Electrical and electronic equipment, Batteries, Packaging	V 1.1.0 2022 Aug 18	pdf 2.2 MB	Download
---	------------------------	---------------	----------

Subject to changes. Please also observe the further product documentation!

WAGO GmbH & Co. KG
Hansastr. 27
32423 Minden
Phone: +49571 887-0 | Fax: +49571 887-169
Email: info.de@wago.com | Web: www.wago.com

Do you have any questions about our products?
We are always happy to take your call at +49 (571) 887-44222.

CAD/CAE-Data

CAE data

WSCAD Universe 286-752/002-000	URL	Download
--------------------------------	---------------------	--------------------------

WSCAD Universe 286-752/002-000	URL	Download
--------------------------------	---------------------	--------------------------

Environmental Product Compliance

Compliance Search

Environmental Product Compliance 286-752/002-000 Optocoupler module; Red status indicator; gray	URL	Download
--	---------------------	--------------------------

Installation Notes

Installation

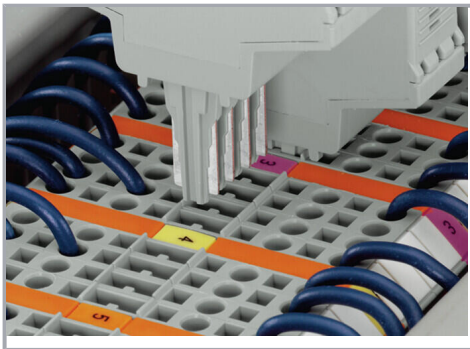

Coding ensures correct polarity.

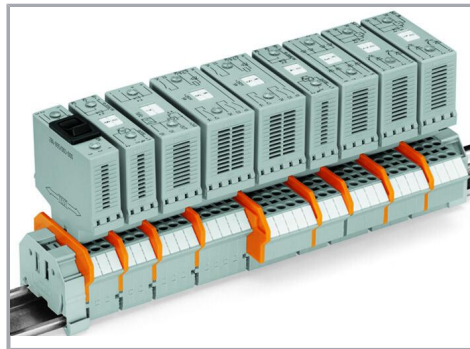

Pluggable electronic modules on 2- or 4-conductor carrier terminal blocks

Marking

Subject to changes. Please also observe the further product documentation!

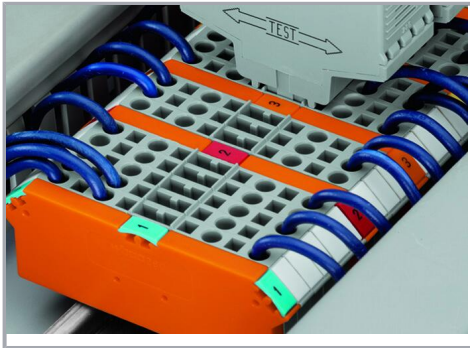

Marking via WMB Multi Marking System.

Testing



Function testing via touch-proof test slots

Subject to changes. Please also observe the further product documentation!