

LXP2-O-90

~10° x 40° oval beam optimized for CREE XP-E.
14.7 mm high assembly with installation tape.
Variant with beam direction rotated 90°.

SPECIFICATION:

Dimensions	Ø 21.6 mm
Height	14.7 mm
Fastening	tape
ROHS compliant	yes ⓘ



MATERIALS:

Component	Type	Material	Colour	Finish
LXP2-O-90	Single lens	PMMA	clear	
LXP2-LH1-TAPE-BLK	Holder	PC	black	
HEIDI-TAPE	Tape	Acrylic foam	black	

ORDERING INFORMATION:

Component		Qty in box	MOQ	MPQ	Box weight (kg)
CA11484_LXP2-O-90	Single lens	1680	336	112	9.2
» Box size: 480 x 280 x 300 mm					

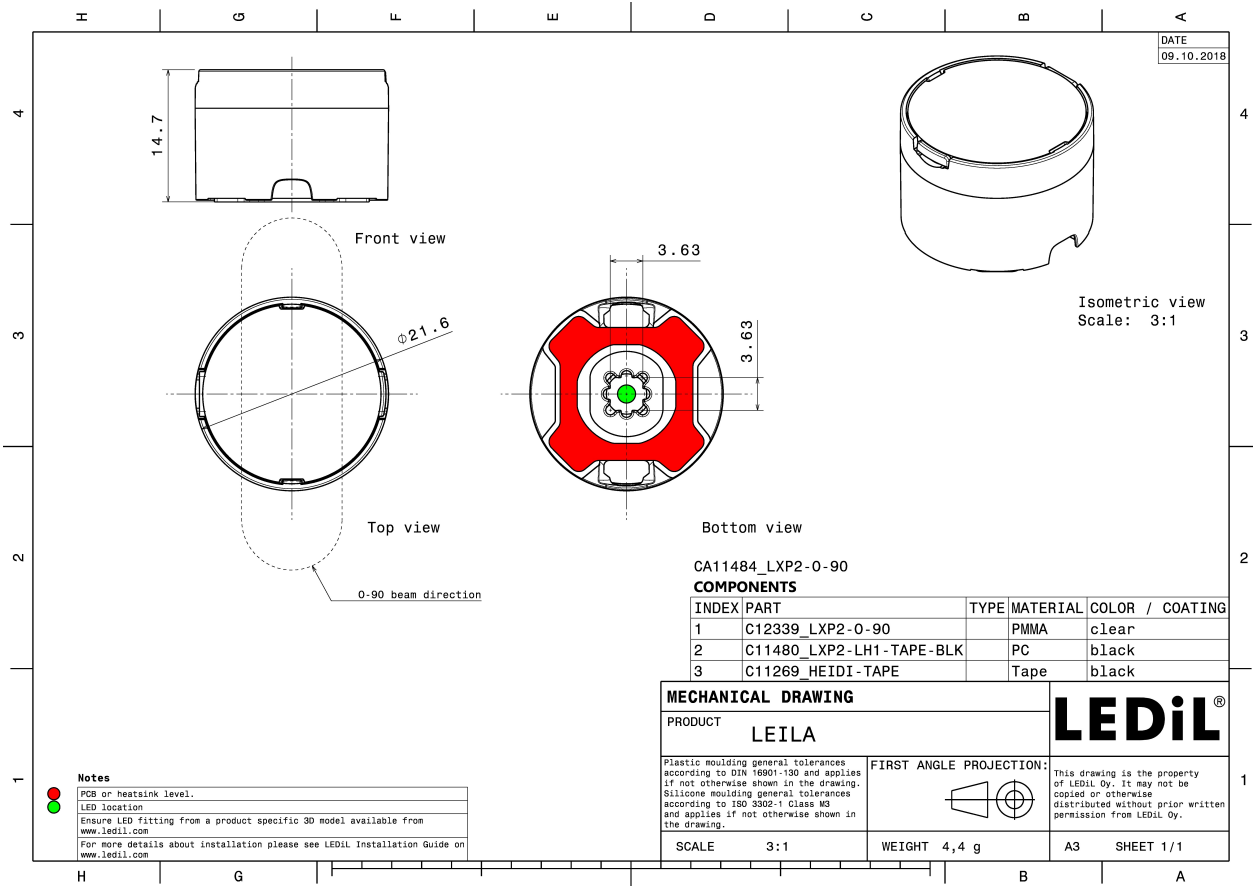

See also our general installation guide: www.ledil.com/installation_guide

OPTICAL RESULTS (MEASURED):

CREE LED

LED XP-E
 FWHM / FWTM 9.0 + 41.0° / 20.0 + 61.0°
 Efficiency 89 %
 Peak intensity 5.8 cd/lm
 LEDs/each optic 1
 Light colour White
 Required components:

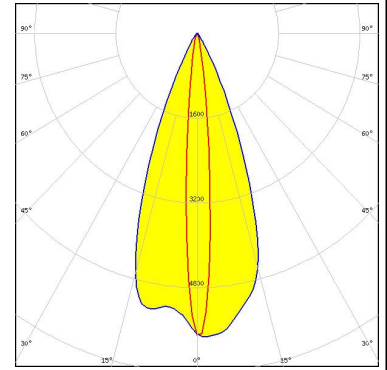

CREE LED

LED XP-E2
 FWHM / FWTM 10.0 + 42.0° / 20.0 + 60.0°
 Efficiency 86 %
 Peak intensity 6.2 cd/lm
 LEDs/each optic 1
 Light colour White
 Required components:

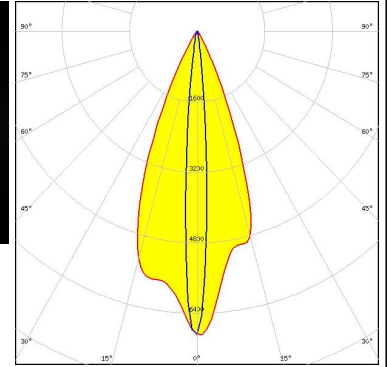

CREE LED

LED XP-G
 FWHM / FWTM 12.0 + 40.0° / 25.0 + 63.0°
 Efficiency 89 %
 Peak intensity 4.6 cd/lm
 LEDs/each optic 1
 Light colour White
 Required components:

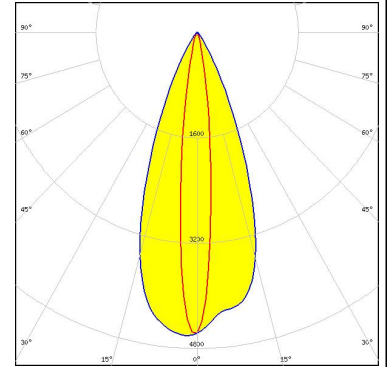

CREE LED

LED XP-G2
 FWHM / FWTM 12.0 + 40.0° / 27.0 + 62.0°
 Efficiency 87 %
 Peak intensity 4.4 cd/lm
 LEDs/each optic 1
 Light colour White
 Required components:

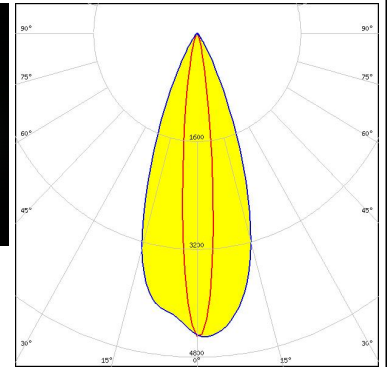

OPTICAL RESULTS (MEASURED):

CREE → LED

LED XP-L HI
 FWHM / FWTM 12.0 + 43.0° / 27.0 + 61.0°
 Efficiency 86 %
 Peak intensity 4.4 cd/lm
 LEDs/each optic 1
 Light colour White
 Required components:

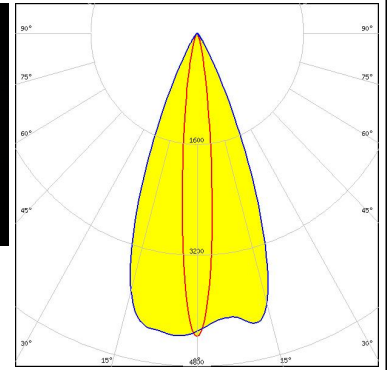
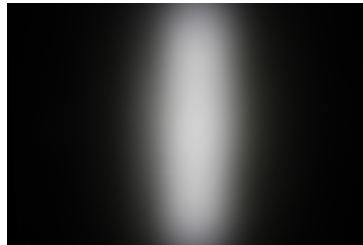

CREE → LED

LED XT-E
 FWHM / FWTM 13.0 + 41.0° / 30.0 + 63.0°
 Efficiency 84 %
 Peak intensity 4.1 cd/lm
 LEDs/each optic 1
 Light colour White
 Required components:

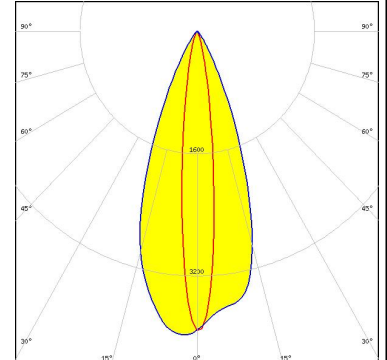

LUMILEDS

LED LUXEON Q
 FWHM / FWTM 12.0 + 41.0° / 62.0 + 27.0°
 Efficiency 85 %
 Peak intensity 4.3 cd/lm
 LEDs/each optic 1
 Light colour White
 Required components:

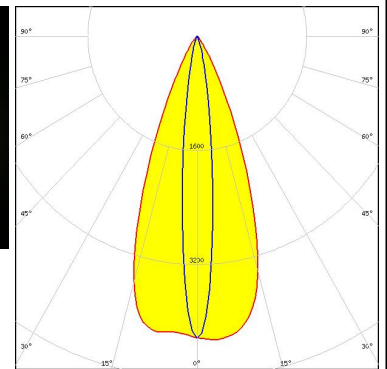
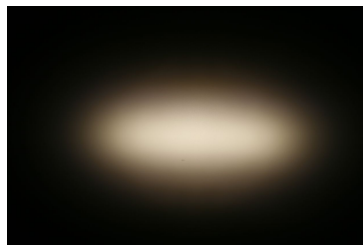

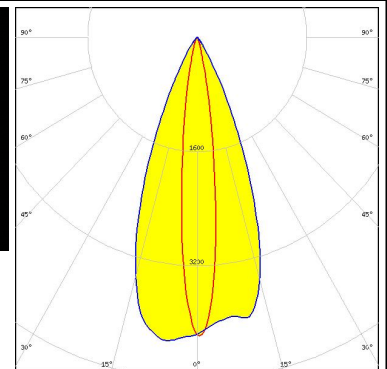
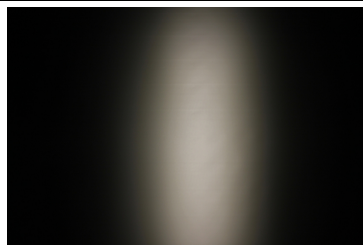

NICHIA

LED NVSW219D
 FWHM / FWTM 13.0 + 42.0° / 28.0 + 62.0°
 Efficiency 89 %
 Peak intensity 4.3 cd/lm
 LEDs/each optic 1
 Light colour White
 Required components:

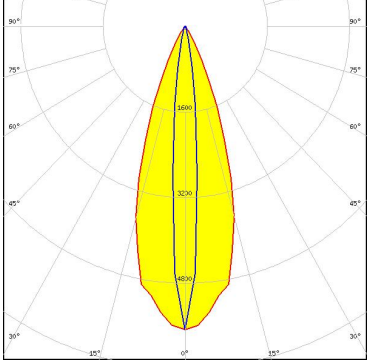

OPTICAL RESULTS (MEASURED):

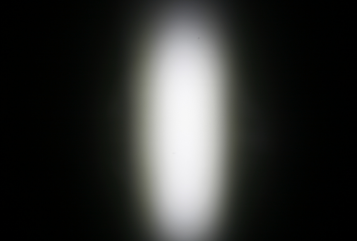
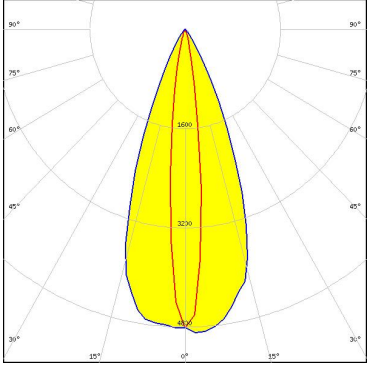
<p> SEUL SEMICONDUCTOR</p> <p>LED Z5</p> <p>FWHM / FWTM 10.0 + 36.0° / 24.0 + 58.0°</p> <p>Efficiency 89 %</p> <p>Peak intensity 5.7 cd/lm</p> <p>LEDs/each optic 1</p> <p>Light colour White</p> <p>Required components:</p>		
<p> SEUL SEMICONDUCTOR</p> <p>LED Z5M1/Z5M2</p> <p>FWHM / FWTM 13.0 + 42.0° / 26.0 + 63.0°</p> <p>Efficiency 90 %</p> <p>Peak intensity 4.9 cd/lm</p> <p>LEDs/each optic 1</p> <p>Light colour White</p> <p>Required components:</p>		

OPTICAL RESULTS (SIMULATED):

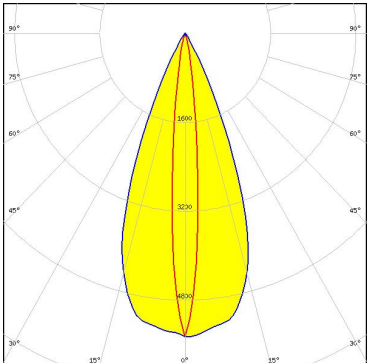
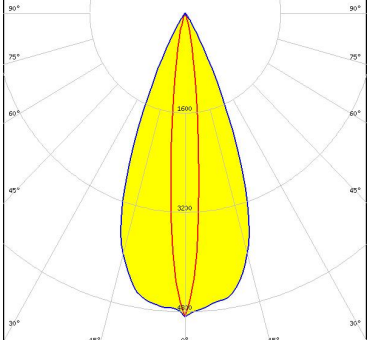
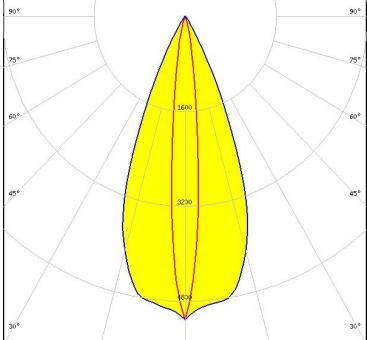
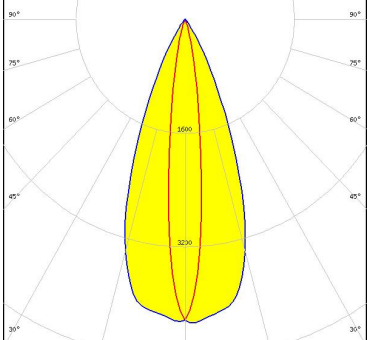
<p>NICHIA</p> <p>LED: NCSxx19B FWHM / FWTM: 10.0 + 42.0° / 22.0 + 58.0° Efficiency: 90 % Peak intensity: 5.5 cd/lm LEDs/each optic: 1 Light colour: Red Required components:</p>	
<p>NICHIA</p> <p>LED: NCSxx19B FWHM / FWTM: 11.0 + 44.0° / 26.0 + 60.0° Efficiency: 90 % Peak intensity: 4.9 cd/lm LEDs/each optic: 1 Light colour: Green Required components:</p>	
<p>NICHIA</p> <p>LED: NCSxx19B FWHM / FWTM: 10.0 + 42.0° / 24.0 + 60.0° Efficiency: 90 % Peak intensity: 5.1 cd/lm LEDs/each optic: 1 Light colour: Blue Required components:</p>	
<p>NICHIA</p> <p>LED: NVSxx19B/NVSxx19C FWHM / FWTM: 12.0 + 42.0° / 28.0 + 62.0° Efficiency: 88 % Peak intensity: 4.3 cd/lm LEDs/each optic: 1 Light colour: White Required components:</p>	

OPTICAL RESULTS (SIMULATED):

OSRAM

Opto Semiconductors

LED OSLON Square CSSRM2/CSSRM3
 FWHM / FWTM 12.0 + 41.0° / 28.0 + 62.0°
 Efficiency 90 %
 Peak intensity 4.7 cd/lm
 LEDs/each optic 1
 Light colour White
 Required components:

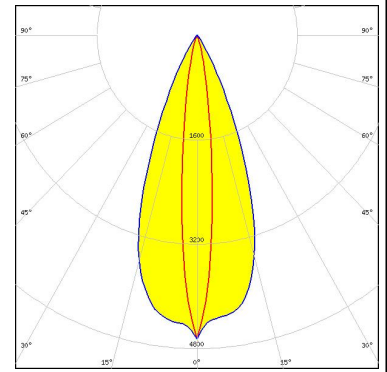

SAMSUNG

LED LH351C
 FWHM / FWTM 14.0 + 42.0° / 28.0 + 64.0°
 Efficiency 83 %
 Peak intensity 4 cd/lm
 LEDs/each optic 1
 Light colour White
 Required components:

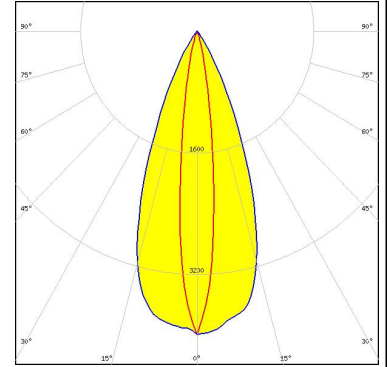

SAMSUNG

LED LM302D
 FWHM / FWTM 13.0 + 42.0° / 32.0 + 62.0°
 Efficiency 88 %
 Peak intensity 4 cd/lm
 LEDs/each optic 1
 Light colour White
 Required components:

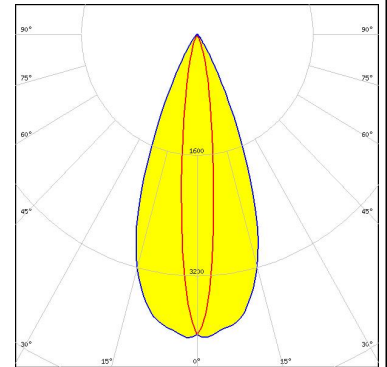

SEOUL SEMICONDUCTOR

LED Z8Y22P
 FWHM / FWTM 40.0 + 14.0° / 64.0 + 34.0°
 Efficiency 87 %
 Peak intensity 3.8 cd/lm
 LEDs/each optic 1
 Light colour White
 Required components:

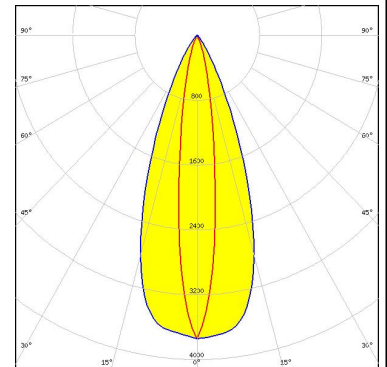

GENERAL INFORMATION:

NOTE: The typical beam angle will be changed by different color, chip size and chip position tolerance. The typical total beam angle is the full angle measured where the luminous intensity is half of the peak value.

MATERIALS:

As part of our continuous research and improvement processes, and to ensure the best possible quality and availability of our products, LEDiL reserves the right to change material grades without notice.

PRODUCT DATA USER AGREEMENT AND DISCLAIMER:

The measured data in the provided downloadable LEDiL Product Datasheets and Mechanical 2D-Drawings is rounded and provided as reference for planning. LEDiL Oy's optical specifications have been verified by conducting performance testing of the products in accordance with the company's quality system. The reported data are averaged results of multiple measurements with typical variation. LEDiL Oy reserves the right to without prior notification make changes and improvements to its products.

LEDiL Oy assumes neither warranty, nor guarantee nor any other liability of any kind for the contents and correctness of the provided data. The provided data has been generated with highest diligence but the provided data may in reality not represent the complete possible variation range of all intrinsic parameters. Therefore, in certain cases a deviation from the provided data could occur.

LEDiL Oy reserves the right to undertake technical changes of its products without further notification which could lead to changes in the provided data. LEDiL Oy assumes no liability of any kind for the possible deviation from any provided data or any other damage resulting from the usage of the provided data.

The user agrees to this disclaimer and user agreement with the download or usage of the provided files.

LEDiL Oy

Joensuunkatu 13
FI-24240 SALO
Finland

LEDiL Inc.

228 West Page Street
Suite D
Sycamore IL 60178
USA

Ledil Optics Technology (Shenzhen) Co., Ltd.

405 , Block B
Casic Motor Building
Shenzhen 518057
P.R.CHINA

Local sales and technical support

[www.ledil.com/
where_to_buy](http://www.ledil.com/where_to_buy)

Shipping locations

Salo, Finland
Hong Kong, China

Distribution Partners

[www.ledil.com/
where_to_buy](http://www.ledil.com/where_to_buy)