

Features

- Low on-state resistance
- Built-in gate protection diode

Applications

- Electric power steering
- High current switching

Internal Equivalent Circuit

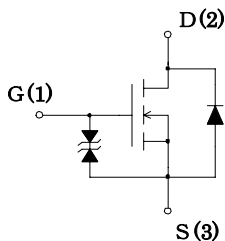

Package

MT100 (TO3P)

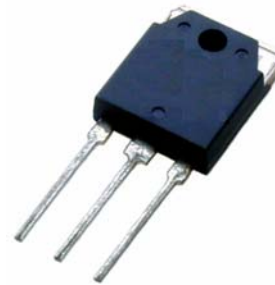

Key Specifications

- $V_{(BR)DSS}=60V$ ($I_D=100\mu A$)
- $R_{DS(ON)}=4.7m\Omega$ Max. ($V_{GS}=10V, I_D=42A$)

Absolute maximum ratings

Characteristic	Symbol	Rating	Unit
Drain to Source Voltage	V_{DSS}	60	V
Gate to Source Voltage	V_{GSS}	± 20	V
Continuous Drain Current	I_D	± 85	A
Pulsed Drain Current	$I_{D(pulse)}^{*1}$	± 280	A
Maximum Power Dissipation	P_D	150 ($T_c=25^\circ C$)	W
Single Pulse Avalanche Energy	E_{AS}^{*2}	280	mJ
Channel Temperature	T_{ch}	-55~150	$^\circ C$
Storage Temperature	T_{stg}	-55~150	$^\circ C$

*1 $PW \leq 100 \mu sec.$ duty cycle $\leq 1\%$

*2 $V_{DD}=20V, L=1mH, I_L=20A,$ unclamped, See Fig.1

The information included herein is believed to be accurate and reliable. However, SANKEN ELECTRIC CO., LTD assumes no responsibility for its use ; nor for any infringements of patents or other rights of third parties that may result from its use.

Electrical characteristics

(Ta=25°C)

Characteristic	Symbol	Test Conditions	Limits			Unit
			MIN	TYP	MAX	
Drain to Source breakdown Voltage	$V_{(BR)DSS}$	$I_D=100\mu A, V_{GS}=0V$	60			V
Gate to Source Leakage Current	I_{GSS}	$V_{GS}=\pm 20V$			± 10	μA
Drain to Source Leakage Current	I_{DSS}	$V_{DS}=60V, V_{GS}=0V$			100	μA
Gate Threshold Voltage	V_{TH}	$V_{DS}=10V, I_D=1mA$	2.0	2.5	3.0	V
Forward Transconductance	$Re(yfs)$	$V_{DS}=10V, I_D=42A$	30			S
Static Drain to Source On-Resistance	$R_{DS(ON)}$	$I_D=42A, V_{GS}=10V$		4.0	4.7	m Ω
Input Capacitance	C_{iss}	$V_{DS}=10V$ $V_{GS}=0V$ $f=1MHz$		11500		pF
Output Capacitance	C_{oss}			1500		
Reverse Transfer Capacitance	C_{rss}			1100		
Turn-On Delay Time	$t_{d(on)}$	$I_D=42A, V_{DD}\square 16V$ $R_G=22\Omega, V_{GS}=10V$ See Fig.2		60		ns
Rise Time	t_r			25		
Turn-Off Delay Time	$t_{d(off)}$			370		
Fall Time	t_f			65		
Source-Drain Diode Forward Voltage	V_{SD}	$I_{SD}=50A, V_{GS}=0V$		0.87	1.5	V
Source-Drain Diode Reverse Recovery Time	t_{rr}	$I_{SD}=50A$ $di/dt=100A/us$		70		ns

The information included herein is believed to be accurate and reliable. However, SANKEN ELECTRIC CO., LTD assumes no responsibility for its use ; nor for any infringements of patents or other rights of third parties that may result from its use.

Characteristic Curves (Tc=25°C)

ID - VDS characteristics (typical)

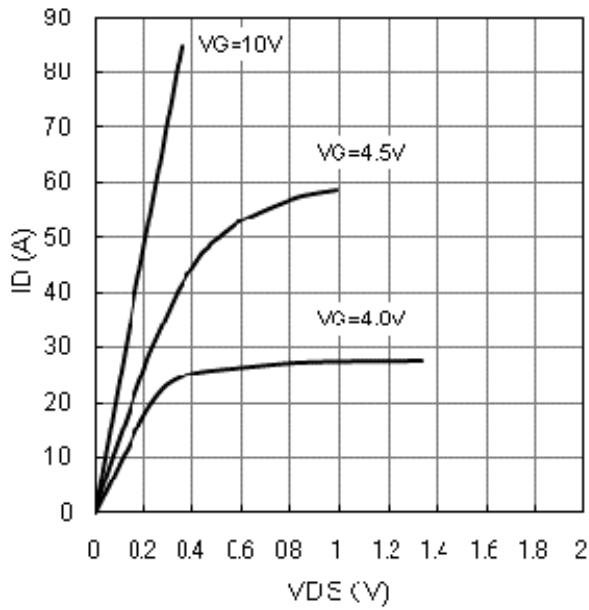

ID - VGS characteristics (typical)

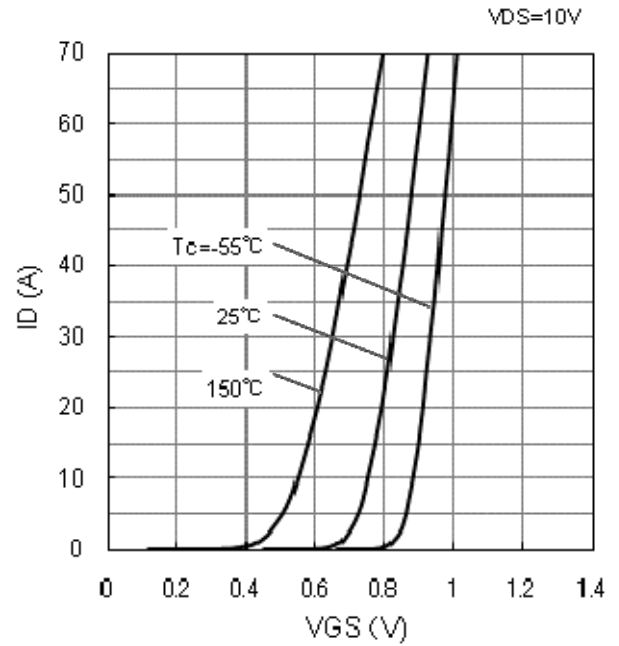

RDS(ON) - Tc characteristics (typical)

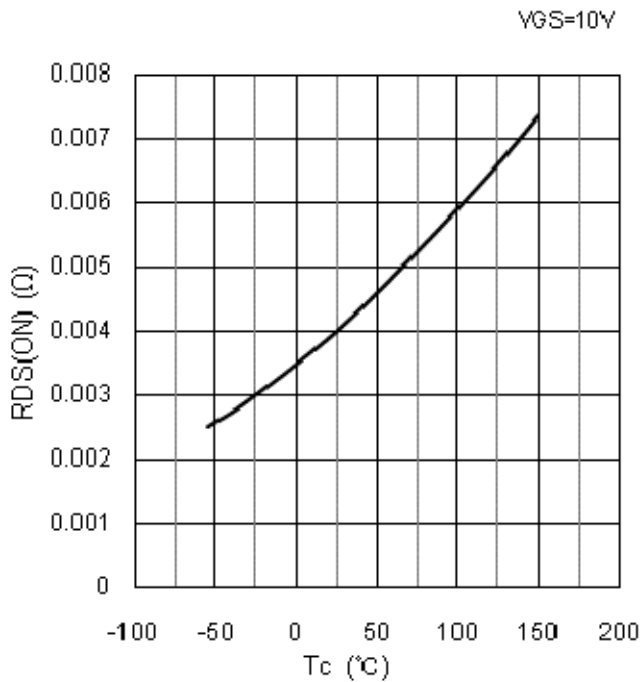

RDS(ON) - ID characteristics (typical)

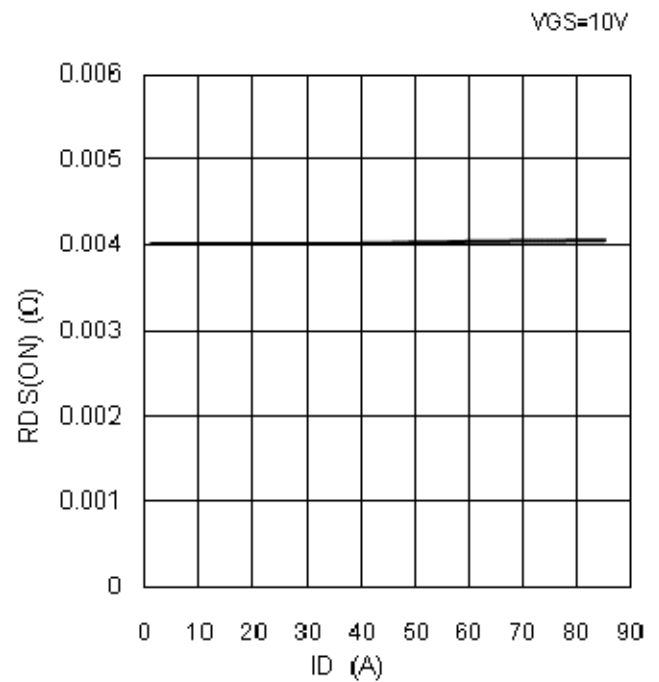

The information included herein is believed to be accurate and reliable. However, SANKEN ELECTRIC CO., LTD assumes no responsibility for its use ; nor for any infringements of patents or other rights of third parties that may result from its use.

Characteristic Curves (Tc=25°C)

VDS - VGS characteristics (typical)

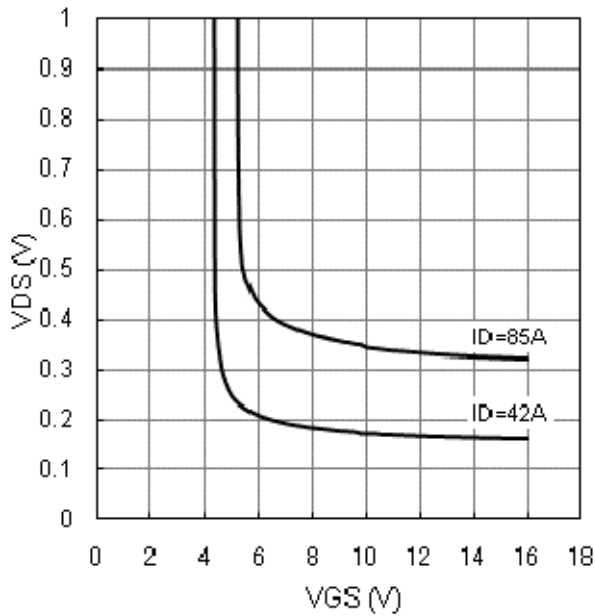

Re(yfs) - ID characteristics (typical)
VDS=10V

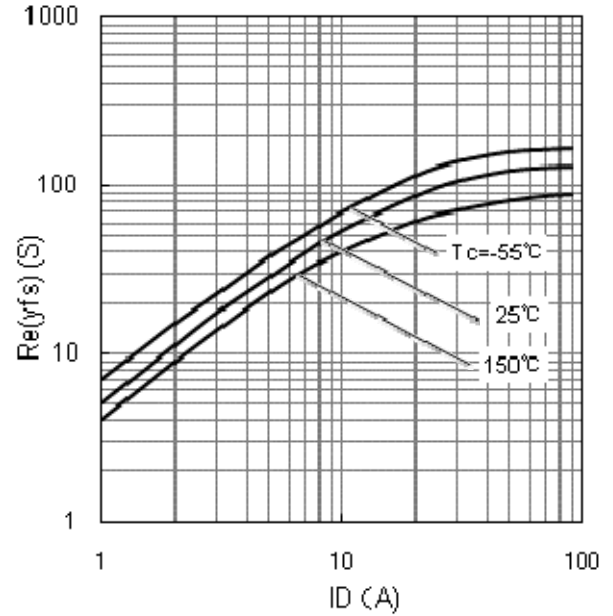

Capacitance - VDS characteristics (typical)
VGS=0V
f=1MHz

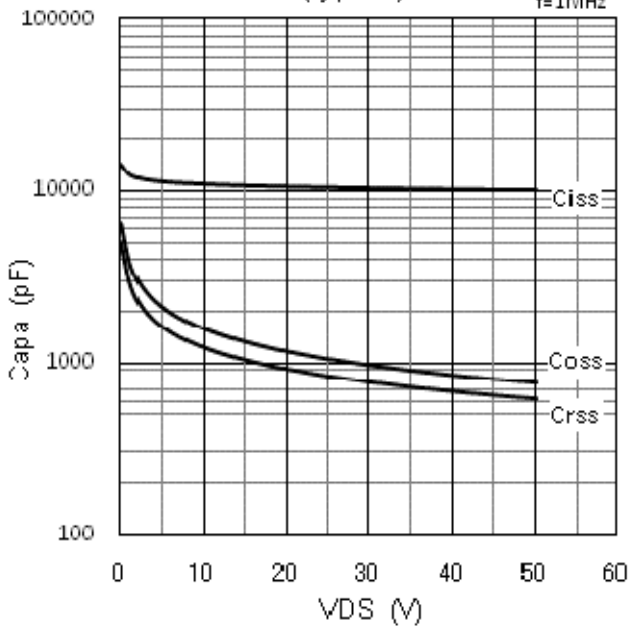

IDR - VSD characteristics (typical)

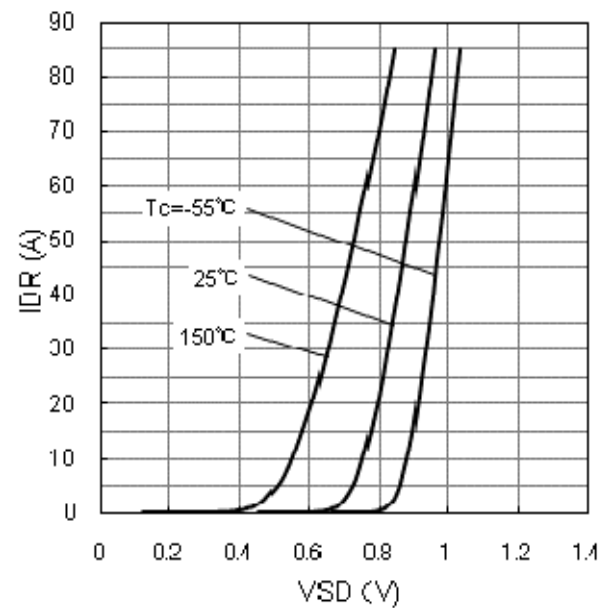

The information included herein is believed to be accurate and reliable. However, SANKEN ELECTRIC CO., LTD assumes no responsibility for its use ; nor for any infringements of patents or other rights of third parties that may result from its use.

Characteristic Curves (Tc=25°C)

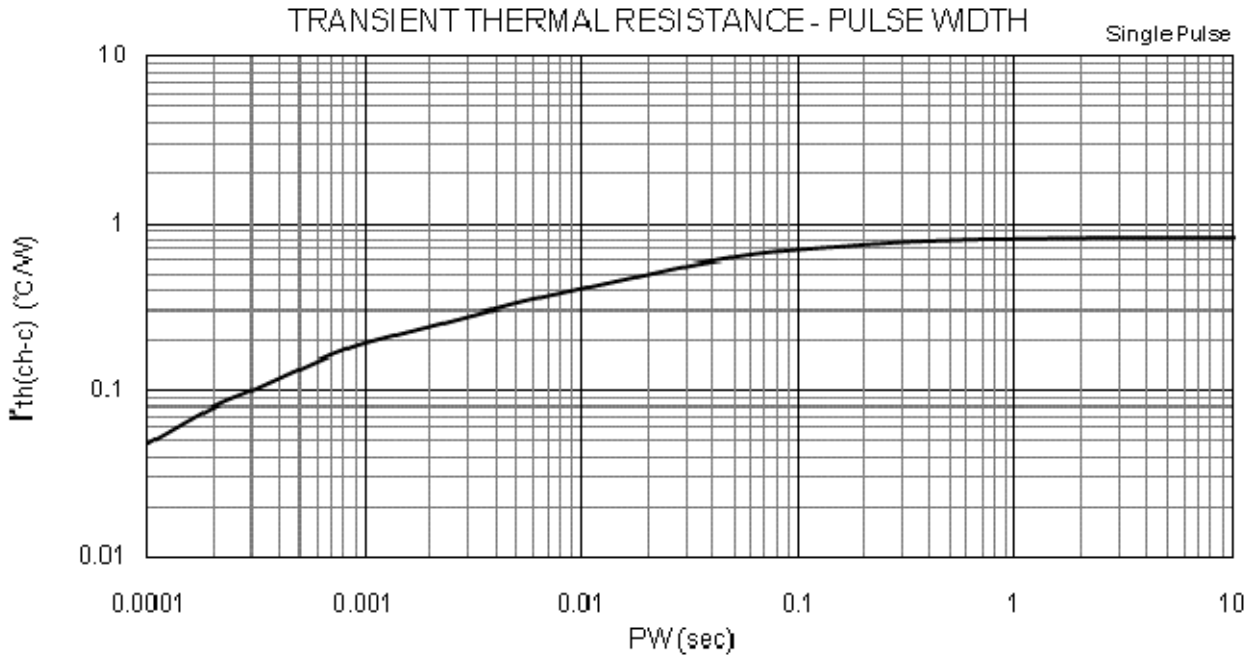

PD-Tc characteristics

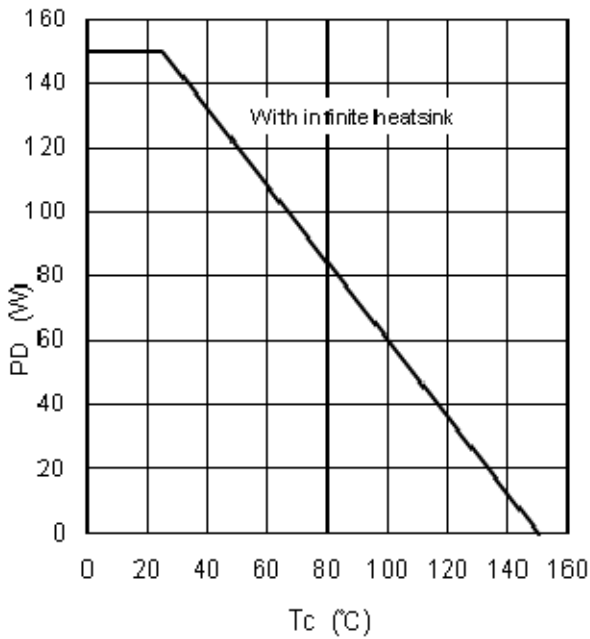

SAFE OPERATING AREA

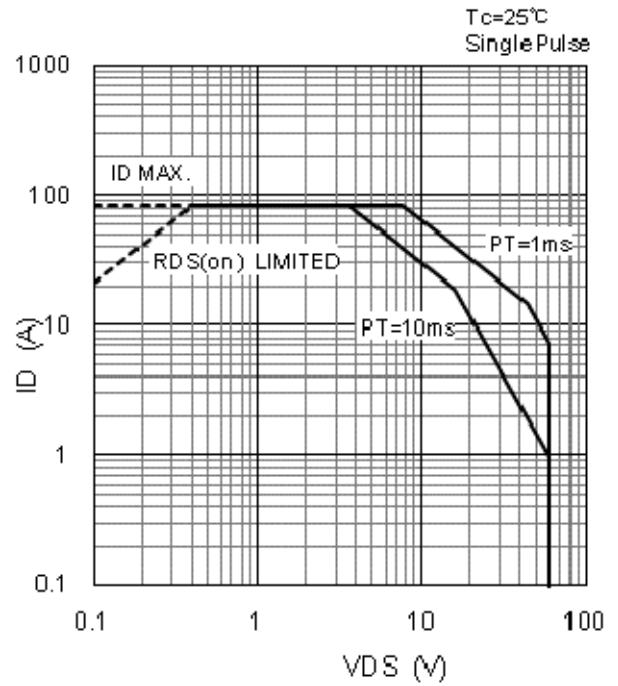

The information included herein is believed to be accurate and reliable. However, SANKEN ELECTRIC CO., LTD assumes no responsibility for its use ; nor for any infringements of patents or other rights of third parties that may result from its use.

Fig.1 Unclamped Inductive Test Method

$$EAS = \frac{1}{2} \cdot L \cdot I_{LP}^2 \cdot \frac{V_{(BR)DSS}}{V_{(BR)DSS} - V_{DD}}$$

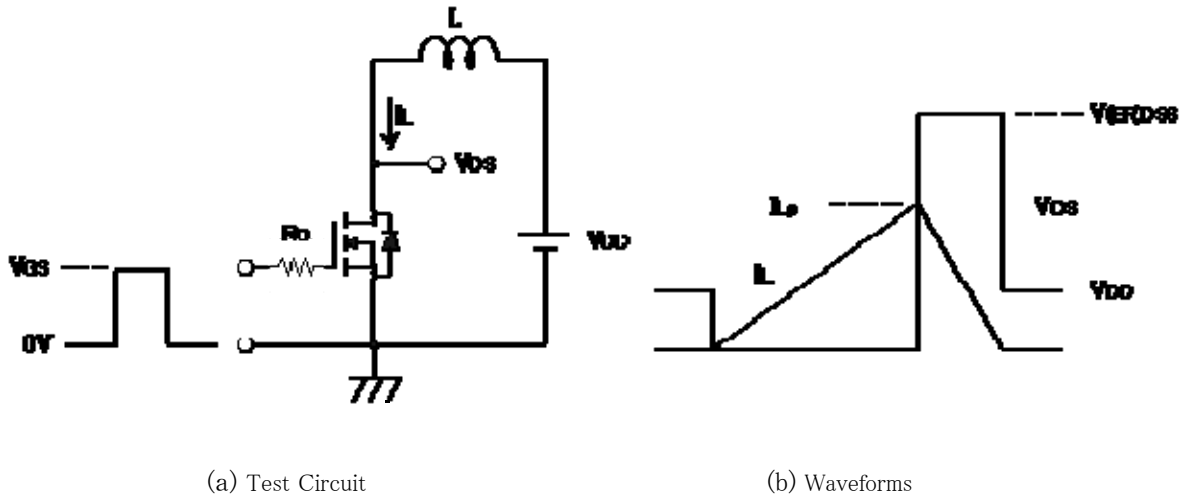
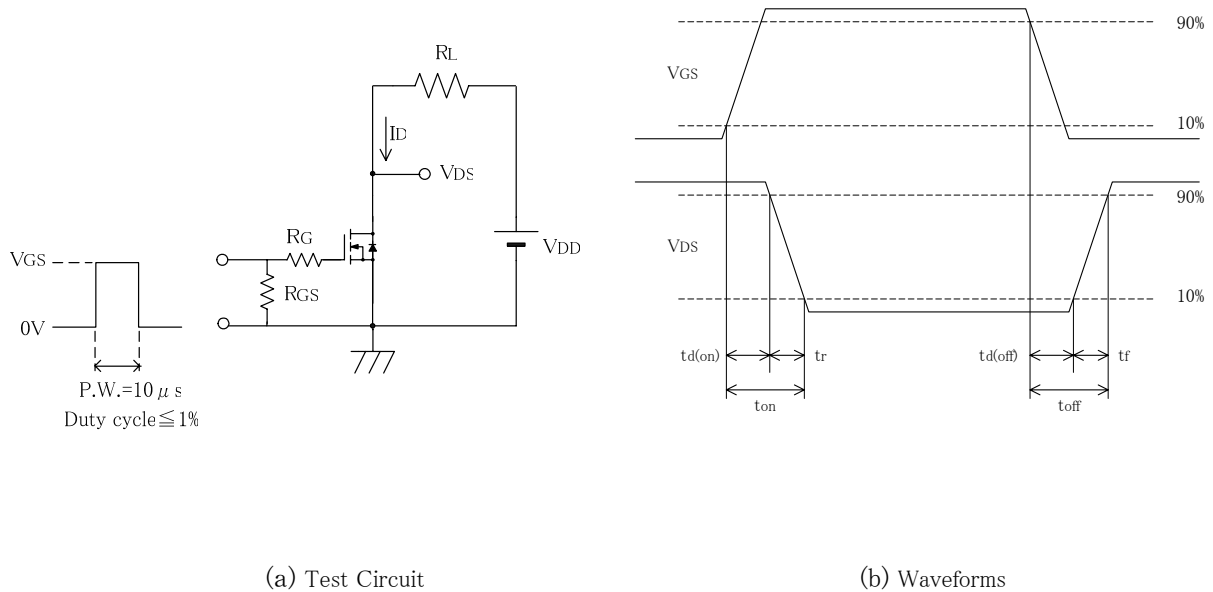

Fig.2 Switching Time Test Method



The information included herein is believed to be accurate and reliable. However, SANKEN ELECTRIC CO., LTD assumes no responsibility for its use ; nor for any infringements of patents or other rights of third parties that may result from its use.

Outline

MT100 (TO3P)

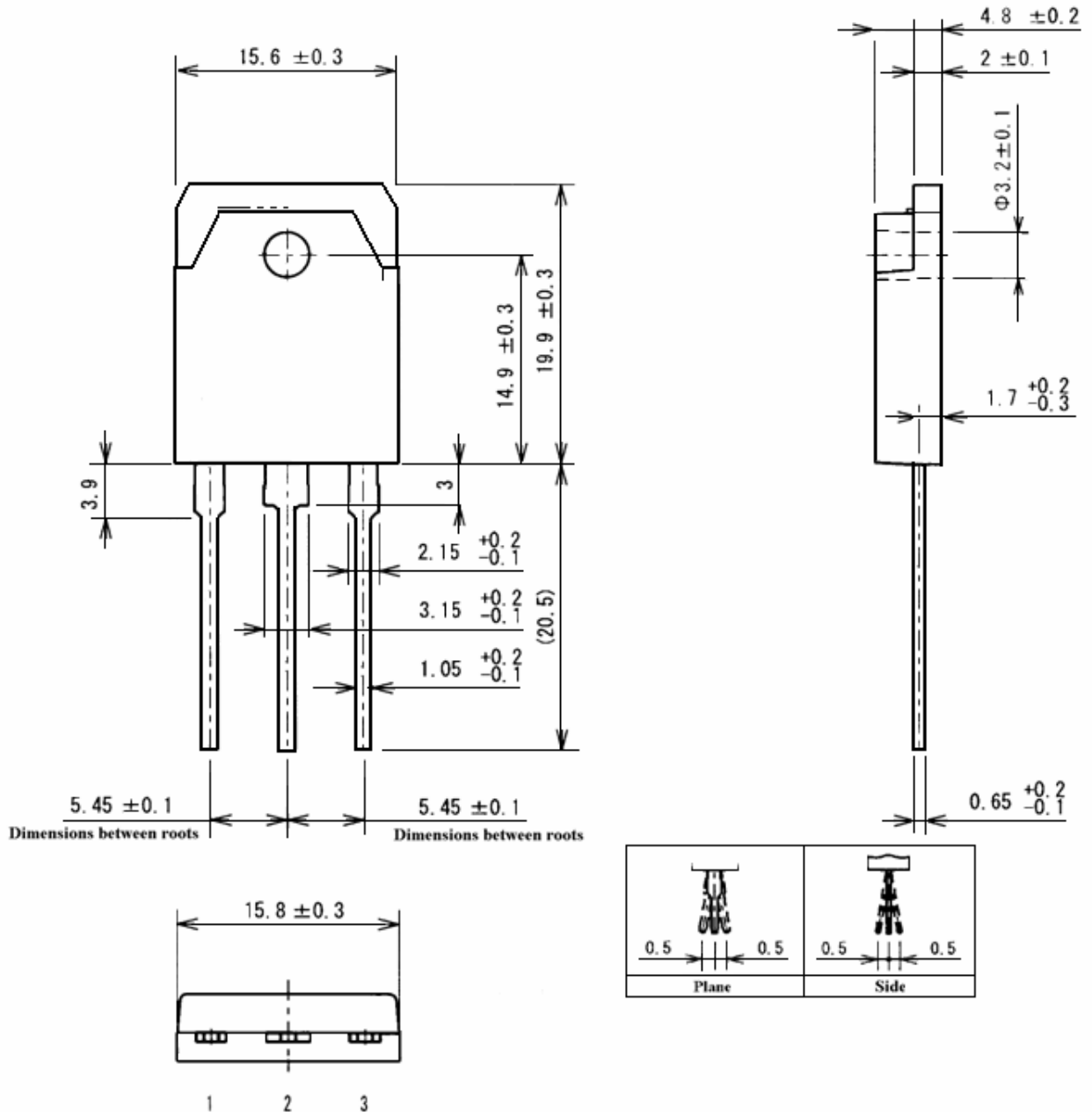

- (1) Gate
- (2) Drain (Back Side)
- (3) Source

Weight Approx. 6g

The information included herein is believed to be accurate and reliable. However, SANKEN ELECTRIC CO., LTD assumes no responsibility for its use ; nor for any infringements of patents or other rights of third parties that may result from its use.