

VERONICA-SQ-MINI-RS

~17° spot beam

SPECIFICATION:

Dimensions	13.9 x 13.9 mm
Height	8.9 mm
Fastening	tape, pin
ROHS compliant	yes ⓘ

MATERIALS:

Component	Type	Material	Colour	Finish
VERONICA-SQ-MINI-RS	Single lens	PMMA	clear	
VERONICA-SQ-MINI-TAPE	Tape	Acrylic foam	clear	

ORDERING INFORMATION:

Component		Qty in box	MOQ	MPQ	Box weight (kg)
CA14601_VERONICA-SQ-MINI-RS	Single lens	5544	252	252	7.9
» Box size: 480 x 280 x 300 mm					



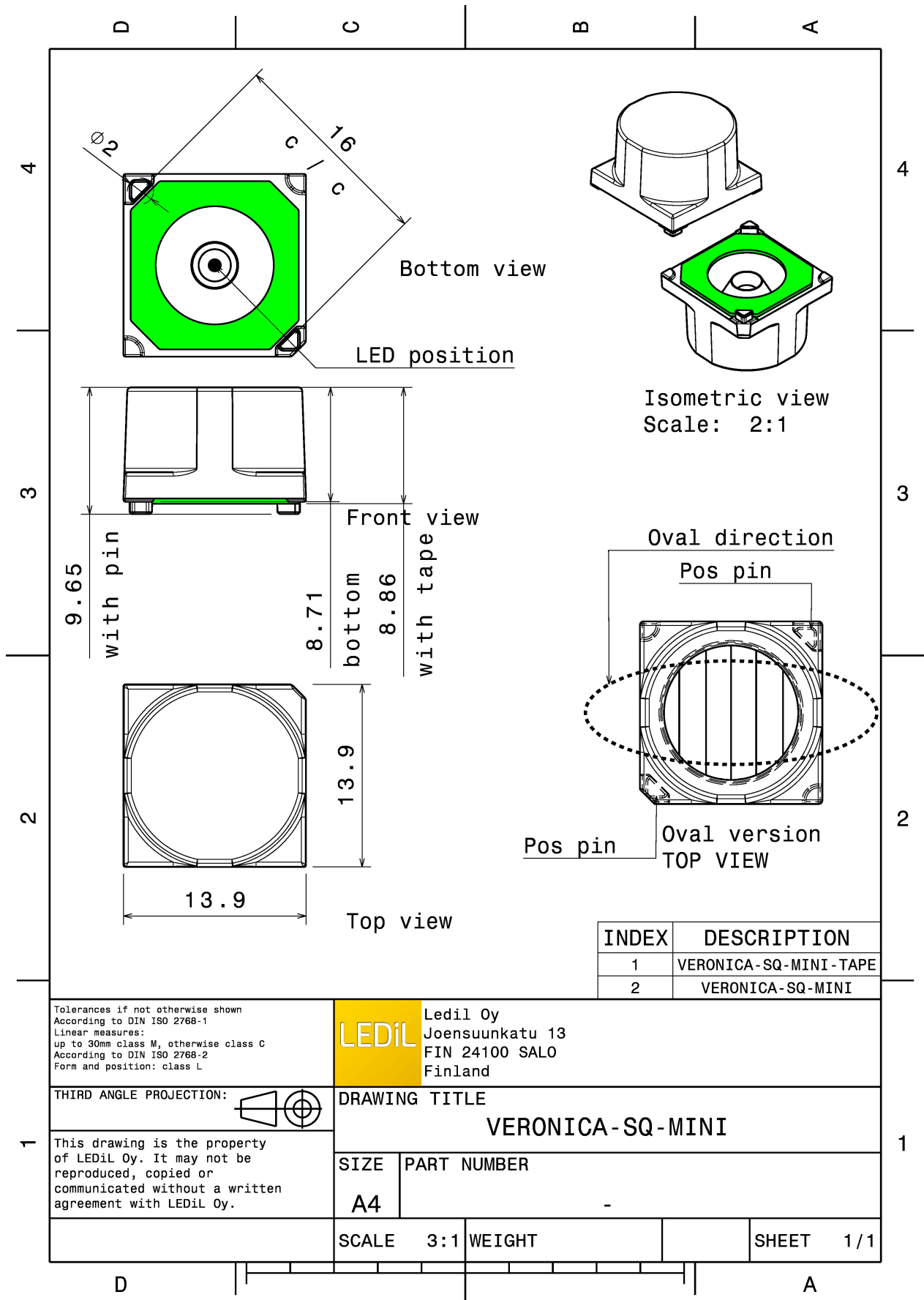

INDEX	DESCRIPTION
1	VERONICA-SQ-MINI-TAPE
2	VERONICA-SQ-MINI

Tolerances if not otherwise shown
 According to DIN ISO 2768-1
 Linear measures:
 up to 30mm class M, otherwise class C
 According to DIN ISO 2768-2
 Form and position: class L

LEDiL Ledil Oy
 Joensuunkatu 13
 FIN 24100 SALO
 Finland

THIRD ANGLE PROJECTION:

DRAWING TITLE
VERONICA-SQ-MINI

This drawing is the property of LEDiL Oy. It may not be reproduced, copied or communicated without a written agreement with LEDiL Oy.

SIZE	PART NUMBER
A4	-

SCALE	3:1	WEIGHT		SHEET	1/1
-------	-----	--------	--	-------	-----

See also our general installation guide: www.ledil.com/installation_guide

OPTICAL RESULTS (MEASURED):

CREE LED

LED XD16
 FWHM / FWTM 19.0° / 36.0°
 Efficiency 92 %
 Peak intensity 4.6 cd/lm
 LEDs/each optic 1
 Light colour White
 Required components:

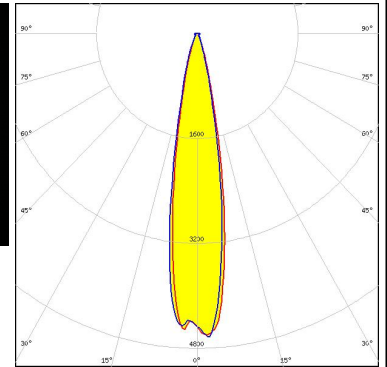

CREE LED

LED XP-E2
 FWHM / FWTM 14.0° / 26.0°
 Efficiency 92 %
 Peak intensity 11 cd/lm
 LEDs/each optic 1
 Light colour White
 Required components:

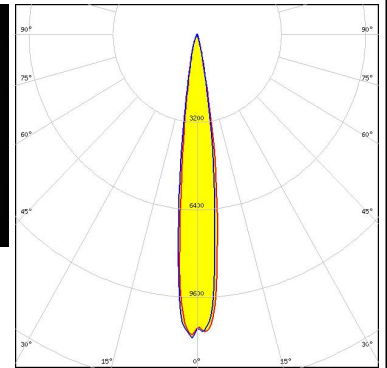

CREE LED

LED XQ-E HI
 FWHM / FWTM 9.4° / 24.0°
 Efficiency 90 %
 Peak intensity 14.7 cd/lm
 LEDs/each optic 1
 Light colour White
 Required components:

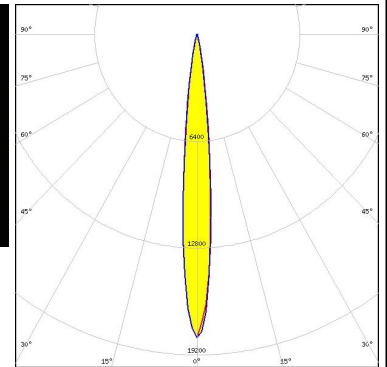

LUMILEDS

LED LUXEON Rebel ES
 FWHM / FWTM 21.0° / 43.0°
 Efficiency 83 %
 Peak intensity 4.3 cd/lm
 LEDs/each optic 1
 Light colour White
 Required components:

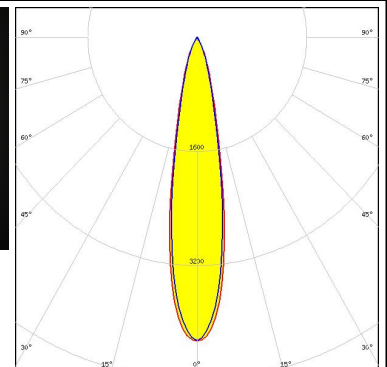
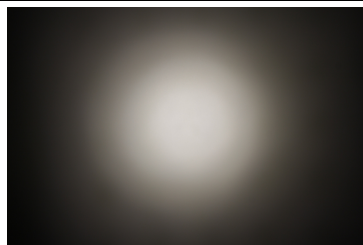

OPTICAL RESULTS (MEASURED):

LUMILEDS

LED LUXEON TX
 FWHM / FWTM 20.0° / 44.0°
 Efficiency 92 %
 Peak intensity 4 cd/m
 LEDs/each optic 1
 Light colour White
 Required components:

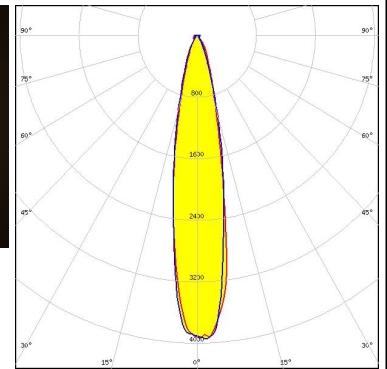
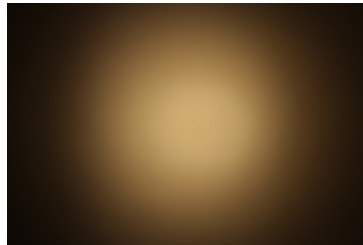

NICHIA

LED NCSxE17A
 FWHM / FWTM 11.0° / 32.0°
 Efficiency 92 %
 Peak intensity 7.6 cd/m
 LEDs/each optic 1
 Light colour White
 Required components:

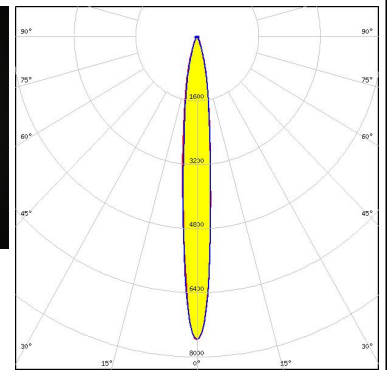
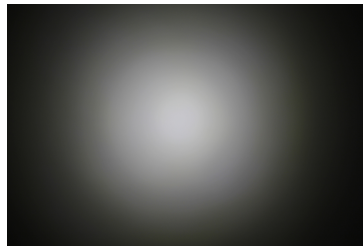

NICHIA

LED NVSxx19B/NVSxx19C
 FWHM / FWTM 21.0° / 45.0°
 Efficiency 93 %
 Peak intensity 3.8 cd/m
 LEDs/each optic 1
 Light colour White
 Required components:

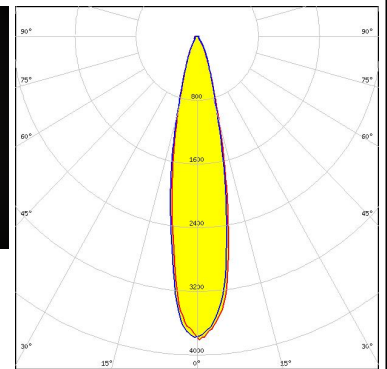
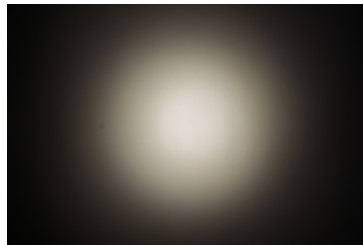

OSRAM

Opto Semiconductors
 LED OSOLON Square EC
 FWHM / FWTM 18.0° / 37.0°
 Efficiency 91 %
 Peak intensity 5.3 cd/m
 LEDs/each optic 1
 Light colour White
 Required components:

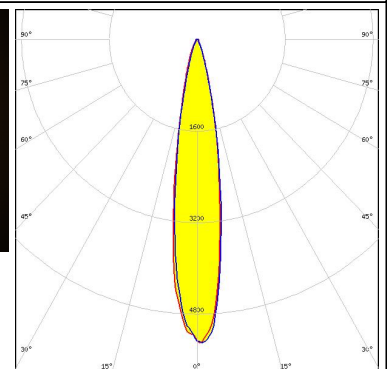
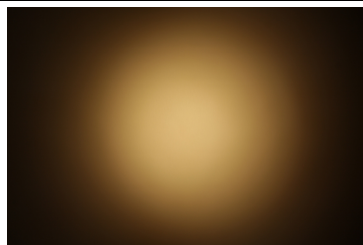

OPTICAL RESULTS (MEASURED):

OSRAM

Opto Semiconductors

LED SFH 4170S
FWHM / FWTM 13.0° / 25.0°
Efficiency %
LEDs/each optic 1
Light colour IR
Required components:

OSRAM

Opto Semiconductors

LED SFH 4180S
FWHM / FWTM 11.0° / 22.0°
Efficiency %
LEDs/each optic 1
Light colour IR
Required components:

SAMSUNG

LED LH181A
FWHM / FWTM 21.0° / 44.0°
Efficiency 86 %
Peak intensity 3 cd/m
LEDs/each optic 1
Light colour White
Required components:

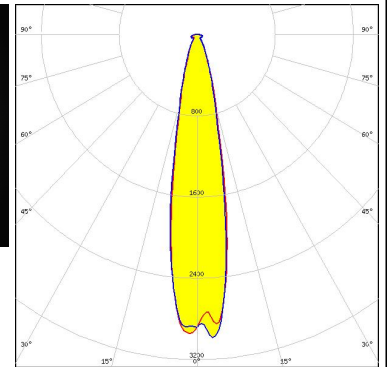

SAMSUNG

LED LH181B
FWHM / FWTM 22.0° / 45.0°
Efficiency 94 %
Peak intensity 3.5 cd/m
LEDs/each optic 1
Light colour White
Required components:

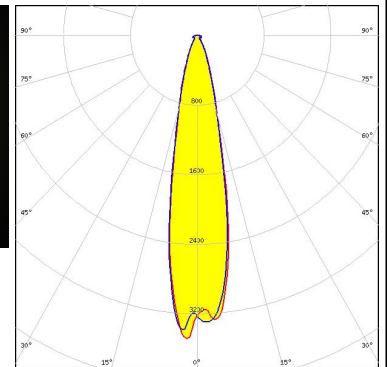

OPTICAL RESULTS (MEASURED):



OPTICAL RESULTS (SIMULATED):

CREE LED

LED XP-E
 FWHM / FWTM 15.0° / 29.0°
 Efficiency 92 %
 Peak intensity 10.3 cd/lm
 LEDs/each optic 1
 Light colour White
 Required components:

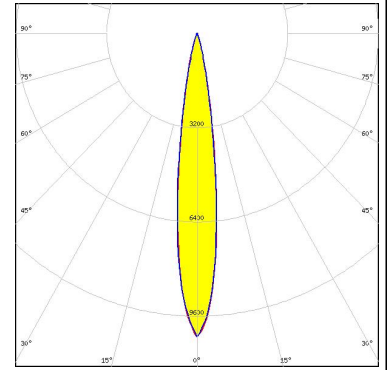

CREE LED

LED XP-G
 FWHM / FWTM 21.0° / 40.0°
 Efficiency 91 %
 Peak intensity 5.2 cd/lm
 LEDs/each optic 1
 Light colour White
 Required components:

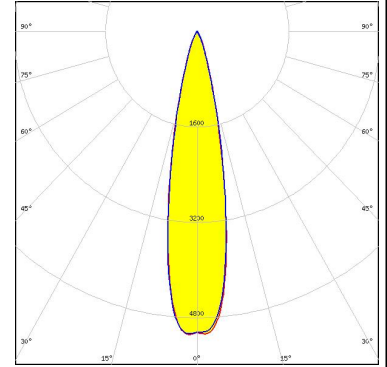

CREE LED

LED XP-G2
 FWHM / FWTM 20.0° / 38.0°
 Efficiency 93 %
 Peak intensity 6 cd/lm
 LEDs/each optic 1
 Light colour White
 Required components:

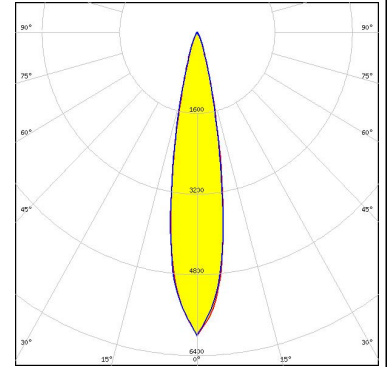

CREE LED

LED XP-G2 HE
 FWHM / FWTM 24.0° / 47.0°
 Efficiency 97 %
 Peak intensity 3.5 cd/lm
 LEDs/each optic 1
 Light colour White
 Required components:

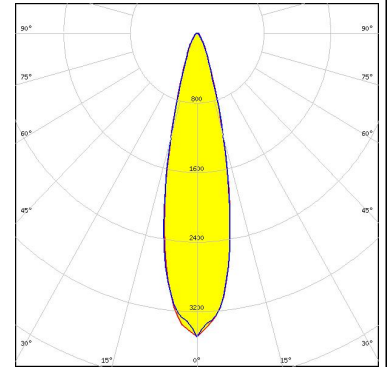

OPTICAL RESULTS (SIMULATED):



LED XQ-E HD
 FWHM / FWTM 13.0° / 28.0°
 Efficiency 89 %
 Peak intensity 11 cd/lm
 LEDs/each optic 1
 Light colour White
 Required components:

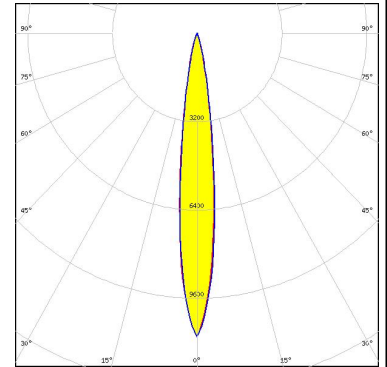

LED LUXEON 2835 Line
 FWHM / FWTM 12.0° / 29.0°
 Efficiency 96 %
 Peak intensity 10 cd/lm
 LEDs/each optic 1
 Light colour PC Amber
 Required components:

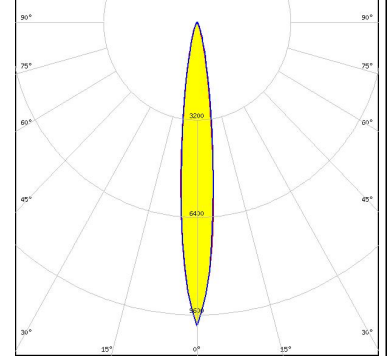

LED LUXEON 3030 2D (Round LES)
 FWHM / FWTM 16.0° / 40.0°
 Efficiency 95 %
 Peak intensity 5.6 cd/lm
 LEDs/each optic 1
 Light colour White
 Required components:

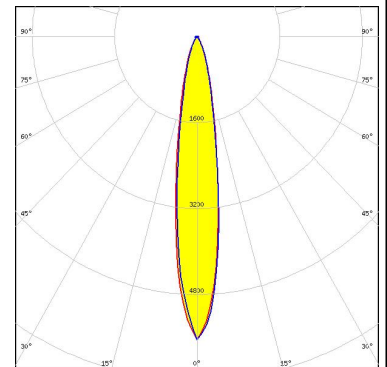

LED LUXEON 3030 HV
 FWHM / FWTM 17.0° / 41.0°
 Efficiency 95 %
 Peak intensity 5.5 cd/lm
 LEDs/each optic 1
 Light colour White
 Required components:

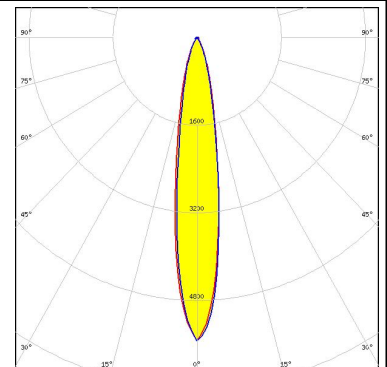

OPTICAL RESULTS (SIMULATED):

LUMILEDS

LED LUXEON A
 FWHM / FWTM 21.0° / 42.0°
 Efficiency 89 %
 Peak intensity 4.5 cd/lm
 LEDs/each optic 1
 Light colour White
 Required components:

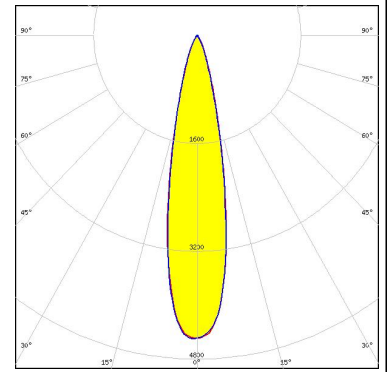

LUMILEDS

LED LUXEON C
 FWHM / FWTM 15.0° / 31.0°
 Efficiency 94 %
 Peak intensity 9.9 cd/lm
 LEDs/each optic 1
 Light colour White
 Required components:

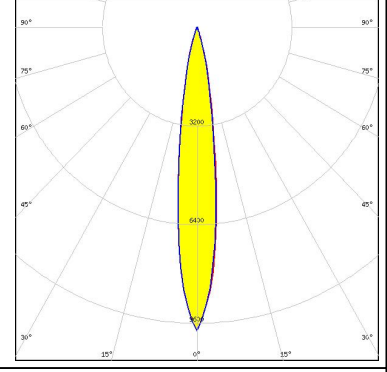

LUMILEDS

LED LUXEON HL1Z
 FWHM / FWTM 12.0° / 30.0°
 Efficiency 96 %
 Peak intensity 10.2 cd/lm
 LEDs/each optic 1
 Light colour White
 Required components:

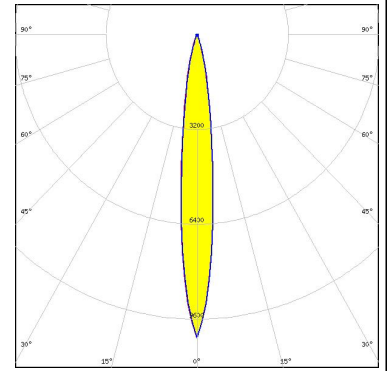

LUMILEDS

LED LUXEON Rebel
 FWHM / FWTM 16.0° / 34.0°
 Efficiency 87 %
 Peak intensity 7.5 cd/lm
 LEDs/each optic 1
 Light colour White
 Required components:

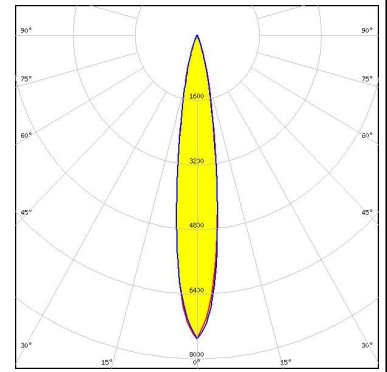

OPTICAL RESULTS (SIMULATED):

LUMILEDS

LED LUXEON T
 FWHM / FWTM 22.0° / 42.0°
 Efficiency 96 %
 Peak intensity 4.7 cd/lm
 LEDs/each optic 1
 Light colour White
 Required components:

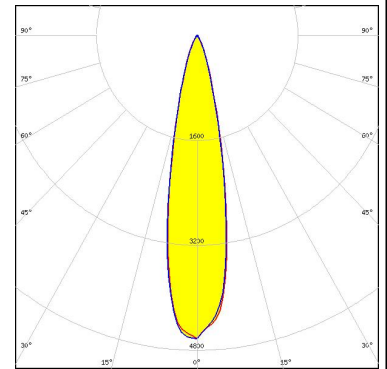

LUMILEDS

LED LUXEON Z ES
 FWHM / FWTM 14.0° / 31.0°
 Efficiency 89 %
 Peak intensity 9.5 cd/lm
 LEDs/each optic 1
 Light colour White
 Required components:

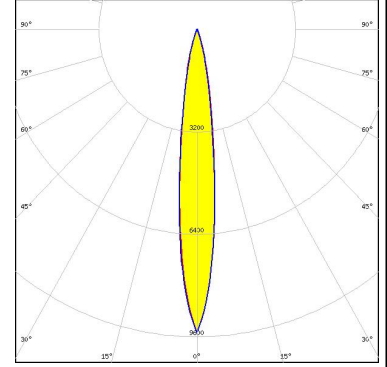

NICHIA

LED NF2x757G
 FWHM / FWTM 19.0° / 40.0°
 Efficiency 97 %
 Peak intensity 5.5 cd/lm
 LEDs/each optic 1
 Light colour White
 Required components:

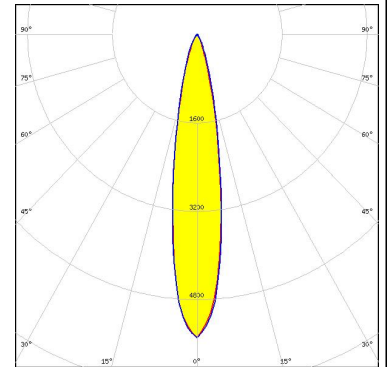

NICHIA

LED NV4WB35AM
 FWHM / FWTM 28.0° / 68.0°
 Efficiency 95 %
 Peak intensity 2.1 cd/lm
 LEDs/each optic 1
 Light colour White
 Required components:

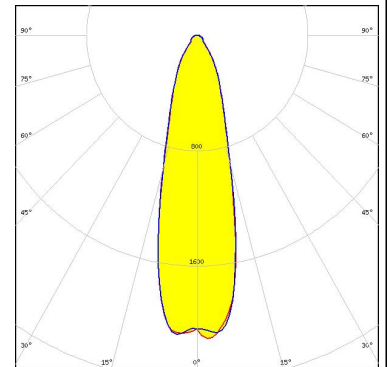

OPTICAL RESULTS (SIMULATED):



LED NVSxE21A
FWHM / FWTM 15.0° / 41.0°
Efficiency 94 %
Peak intensity 5.3 cd/lm
LEDs/each optic 1
Light colour White
Required components:

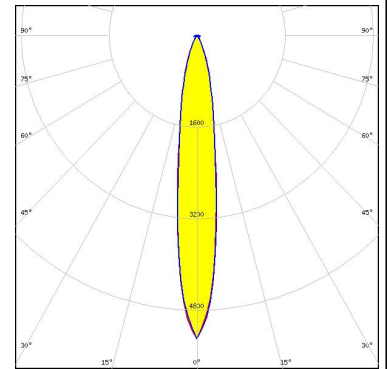

LED OSCONIQ P 3737 (2W version)
FWHM / FWTM 18.0° / 39.0°
Efficiency 94 %
Peak intensity 5.8 cd/lm
LEDs/each optic 1
Light colour White
Required components:

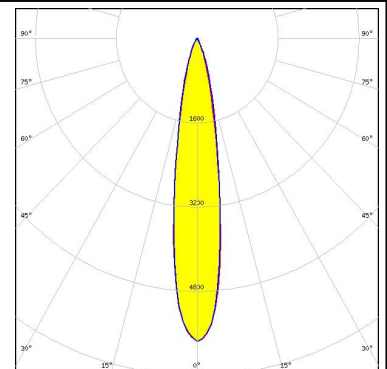

LED OSCONIQ P 3737 (3W version)
FWHM / FWTM 25.0° / 43.0°
Efficiency 89 %
Peak intensity 2.6 cd/lm
LEDs/each optic 1
Light colour White
Required components:

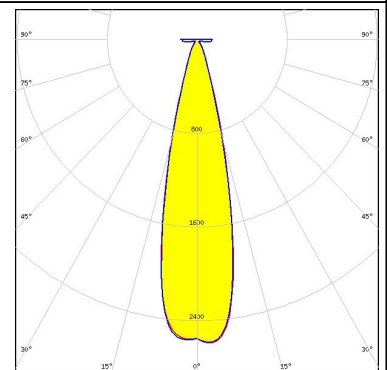

LED OSLOM Square CSSRM2/CSSRM3
FWHM / FWTM 18.0° / 39.0°
Efficiency 92 %
Peak intensity 5.9 cd/lm
LEDs/each optic 1
Light colour White
Required components:

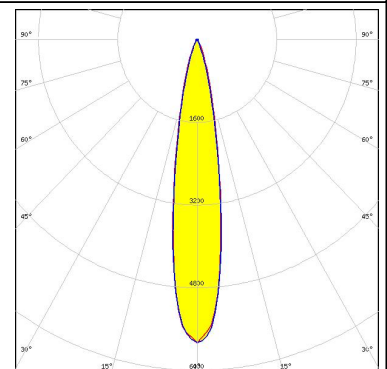

OPTICAL RESULTS (SIMULATED):

OSRAM

Opto Semiconductors

LED OSLO[®] SSL 150
 FWHM / FWTM 14.0° / 28.0°
 Efficiency 89 %
 Peak intensity 10.7 cd/lm
 LEDs/each optic 1
 Light colour White
 Required components:

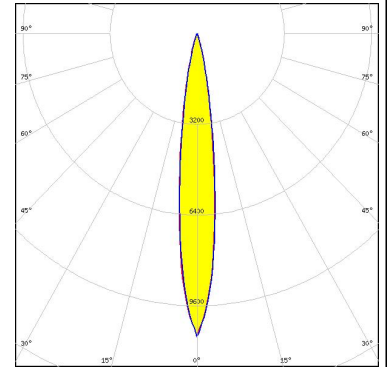

OSRAM

Opto Semiconductors

LED OSLO[®] SSL 80
 FWHM / FWTM 14.0° / 29.0°
 Efficiency 90 %
 Peak intensity 10.2 cd/lm
 LEDs/each optic 1
 Light colour White
 Required components:

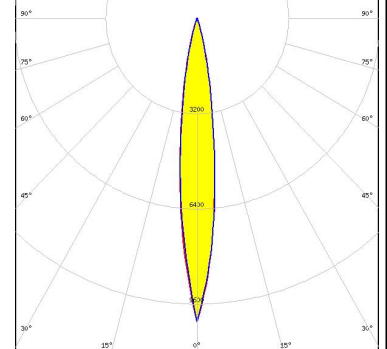

SAMSUNG

LED LH351B
 FWHM / FWTM 24.0° / 46.0°
 Efficiency 94 %
 Peak intensity 3.9 cd/lm
 LEDs/each optic 1
 Light colour White
 Required components:

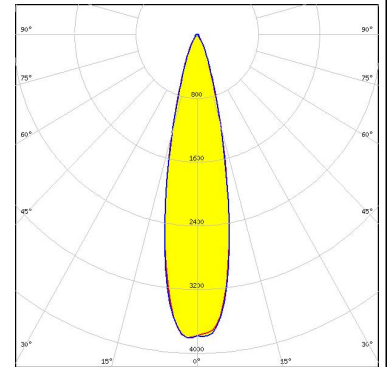

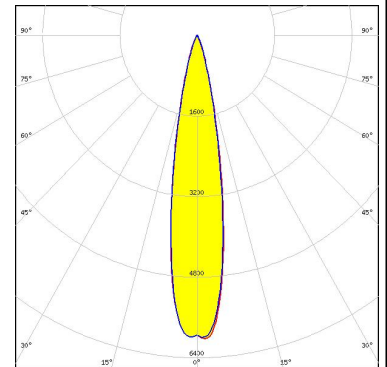

SAMSUNG

LED LH351Z
 FWHM / FWTM 19.0° / 36.0°
 Efficiency 92 %
 Peak intensity 6.1 cd/lm
 LEDs/each optic 1
 Light colour White
 Required components:

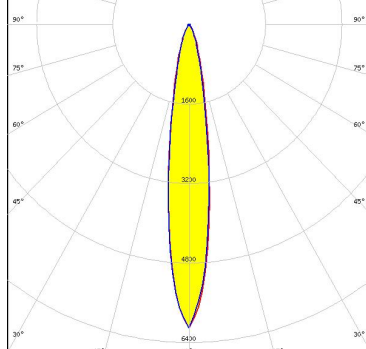

OPTICAL RESULTS (SIMULATED):

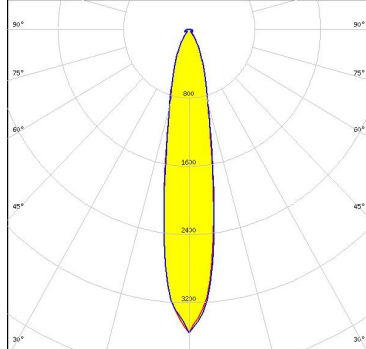
<p> SEOU SEMICONDUCTOR</p> <p>LED MJT 3030</p> <p>FWHM / FWTM 16.0° / 38.0°</p> <p>Efficiency 96 %</p> <p>Peak intensity 6.1 cd/lm</p> <p>LEDs/each optic 1</p> <p>Light colour White</p> <p>Required components:</p>	
<p> SEOU SEMICONDUCTOR</p> <p>LED Z8Y22T</p> <p>FWHM / FWTM 19.0° / 50.0°</p> <p>Efficiency 94 %</p> <p>Peak intensity 3.6 cd/lm</p> <p>LEDs/each optic 1</p> <p>Light colour White</p> <p>Required components:</p>	

GENERAL INFORMATION:

NOTE: The typical beam angle will be changed by different color, chip size and chip position tolerance. The typical total beam angle is the full angle measured where the luminous intensity is half of the peak value.

MATERIALS:

As part of our continuous research and improvement processes, and to ensure the best possible quality and availability of our products, LEDiL reserves the right to change material grades without notice.

PRODUCT DATA USER AGREEMENT AND DISCLAIMER:

The measured data in the provided downloadable LEDiL Product Datasheets and Mechanical 2D-Drawings is rounded and provided as reference for planning. LEDiL Oy's optical specifications have been verified by conducting performance testing of the products in accordance with the company's quality system. The reported data are averaged results of multiple measurements with typical variation. LEDiL Oy reserves the right to without prior notification make changes and improvements to its products.

LEDiL Oy assumes neither warranty, nor guarantee nor any other liability of any kind for the contents and correctness of the provided data. The provided data has been generated with highest diligence but the provided data may in reality not represent the complete possible variation range of all intrinsic parameters. Therefore, in certain cases a deviation from the provided data could occur.

LEDiL Oy reserves the right to undertake technical changes of its products without further notification which could lead to changes in the provided data. LEDiL Oy assumes no liability of any kind for the possible deviation from any provided data or any other damage resulting from the usage of the provided data.

The user agrees to this disclaimer and user agreement with the download or usage of the provided files.

LEDiL Oy

Joensuunkatu 13
FI-24240 SALO
Finland

LEDiL Inc.

228 West Page Street
Suite D
Sycamore IL 60178
USA

Ledil Optics Technology (Shenzhen) Co., Ltd.

405 , Block B
Casic Motor Building
Shenzhen 518057
P.R.CHINA

Local sales and technical support

[www.ledil.com/
where_to_buy](http://www.ledil.com/where_to_buy)

Shipping locations

Salo, Finland
Hong Kong, China

Distribution Partners

[www.ledil.com/
where_to_buy](http://www.ledil.com/where_to_buy)