

## MIRA-M

~30° medium beam

### SPECIFICATION:

Dimensions	Ø 32.4 mm
Height	14.7 mm
Fastening	glue
ROHS compliant	yes ⓘ

### MATERIALS:

Component	Type	Material	Colour	Finish
MIRA-M	Single lens	PC	clear	



### ORDERING INFORMATION:

Component	Qty in box	MOQ	MPQ	Box weight (kg)
C12500_MIRA-M » Box size: 480 x 280 x 300 mm	840	120	60	7.3

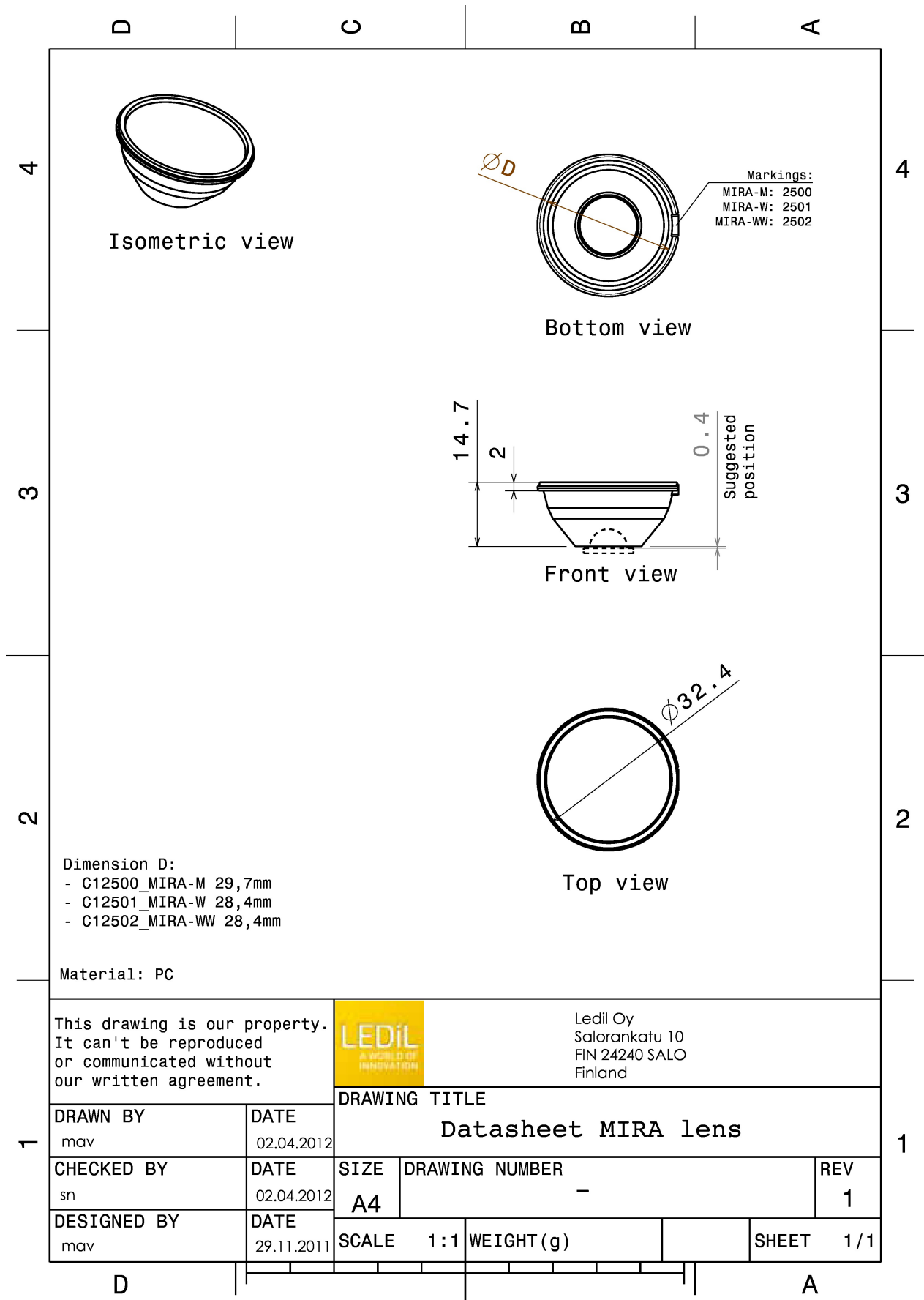

This drawing is our property. It can't be reproduced or communicated without our written agreement.









Ledil Oy  
Salorankatu 10  
FIN 24240 SALO  
Finland

DRAWN BY mav		DATE 02.04.2012	DRAWING TITLE <b>Datasheet MIRA lens</b>		
CHECKED BY sn	DATE 02.04.2012	SIZE <b>A4</b>	DRAWING NUMBER -		REV <b>1</b>
DESIGNED BY mav	DATE 29.11.2011	SCALE 1:1	WEIGHT (g)	SHEET 1/1	

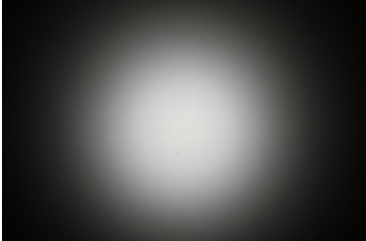
See also our general installation guide: [www.ledil.com/installation\\_guide](http://www.ledil.com/installation_guide)

### OPTICAL RESULTS (MEASURED):

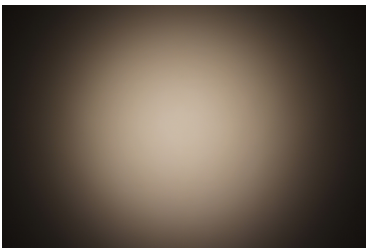
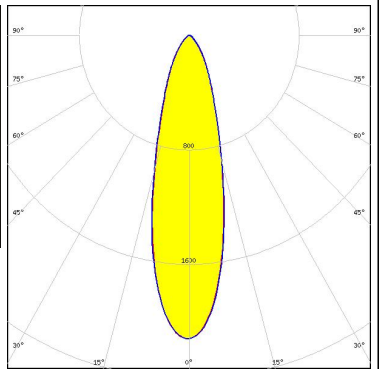
<p></p> <p>LED BXRA ES Star</p> <p>FWHM / FWTM 30.0° / 66.0°</p> <p>Efficiency 82 %</p> <p>LEDs/each optic 1</p> <p>Light colour White</p> <p>Required components:</p>	
<p></p> <p>LED V10 Gen6</p> <p>FWHM / FWTM 35.0° / 72.0°</p> <p>Efficiency 77 %</p> <p>Peak intensity 1.8 cd/lm</p> <p>LEDs/each optic 1</p> <p>Light colour White</p> <p>Required components:</p>	
<p></p> <p>LED CXA/B 15xx</p> <p>FWHM / FWTM 31.0° / 67.0°</p> <p>Efficiency 85 %</p> <p>Peak intensity 2 cd/lm</p> <p>LEDs/each optic 1</p> <p>Light colour White</p> <p>Required components:</p>	
<p></p> <p>LED MHD-E/G</p> <p>FWHM / FWTM 28.0° / 65.0°</p> <p>Efficiency 85 %</p> <p>Peak intensity 2.1 cd/lm</p> <p>LEDs/each optic 1</p> <p>Light colour White</p> <p>Required components:</p>	 

### OPTICAL RESULTS (MEASURED):

#### CREE LED

LED MT-G  
 FWHM / FWTM 28.0° / 62.0°  
 Efficiency 83 %  
 Peak intensity 2.2 cd/lm  
 LEDs/each optic 1  
 Light colour White  
 Required components:

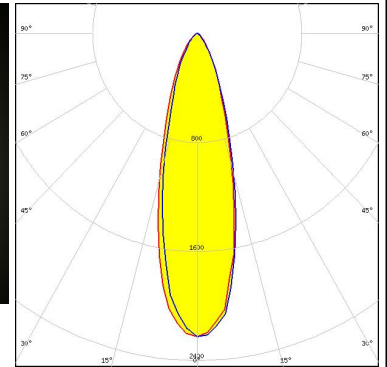

#### CREE LED

LED XHP70  
 FWHM / FWTM 27.0° / 63.0°  
 Efficiency 83 %  
 Peak intensity 2.2 cd/lm  
 LEDs/each optic 1  
 Light colour White  
 Required components:

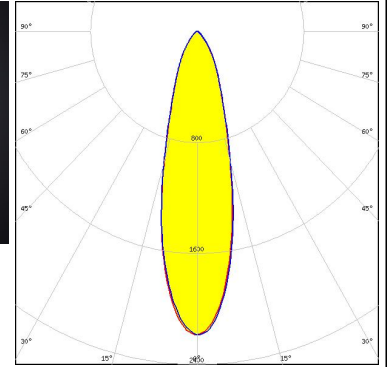

#### LUMILEDS

LED LUXEON M/MX  
 FWHM / FWTM 25.0° / 64.0°  
 Efficiency 81 %  
 LEDs/each optic 1  
 Light colour White  
 Required components:

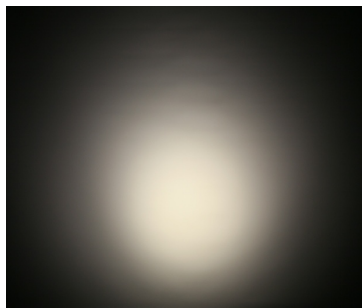



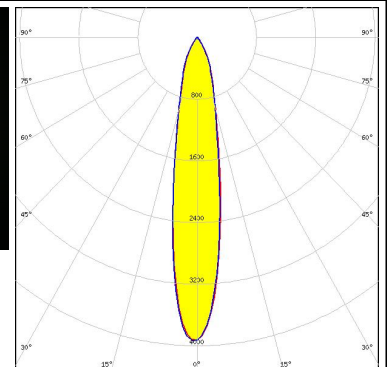

#### LUMILEDS

LED LUXEON MZ  
 FWHM / FWTM 19.0° / 50.0°  
 Efficiency 81 %  
 Peak intensity 3.9 cd/lm  
 LEDs/each optic 1  
 Light colour White  
 Required components:

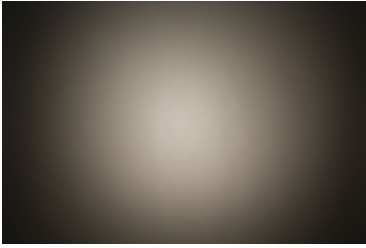
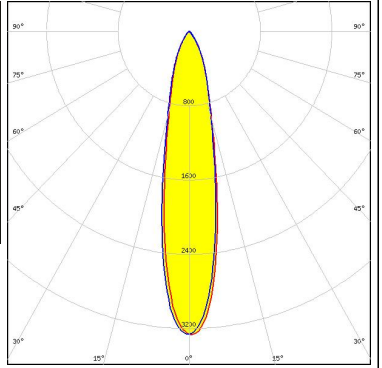
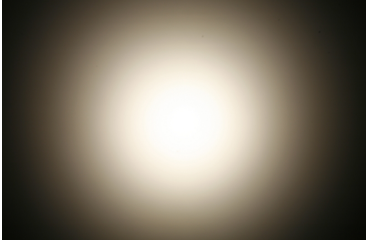
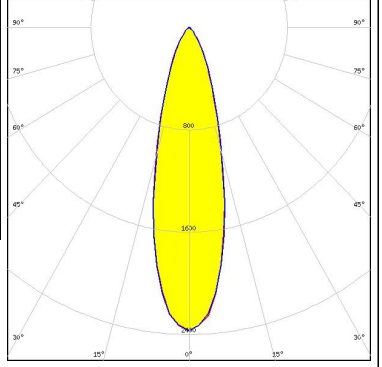

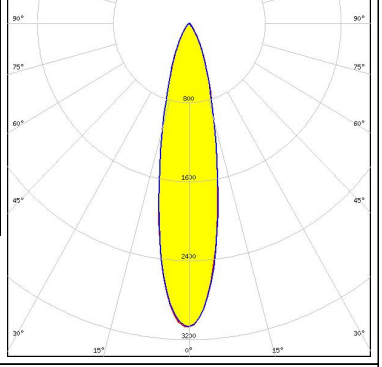
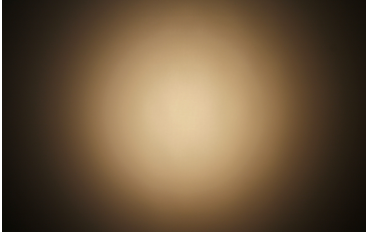
### OPTICAL RESULTS (MEASURED):

<p><b>NICHIA</b></p> <p>LED NFMW48xA            FWHM / FWTM 21.0° / 53.0°            Efficiency 82 %            Peak intensity 3.3 cd/m            LEDs/each optic 1            Light colour White            Required components:</p>		
<p><b>NICHIA</b></p> <p>LED NSCxL036A            FWHM / FWTM 28.0° / 60.0°            Efficiency 80 %            Peak intensity 2.4 cd/m            LEDs/each optic 1            Light colour White            Required components:</p>		
<p><b>NICHIA</b></p> <p>LED NSMx286M            FWHM / FWTM 23.0° / 53.0°            Efficiency 80 %            Peak intensity 3.1 cd/m            LEDs/each optic 1            Light colour White            Required components:</p>		
<p><b>OSRAM</b>  <small>Opto Semiconductors</small></p> <p>LED Duris S10            FWHM / FWTM 22.0° / 52.0°            Efficiency 83 %            Peak intensity 3.6 cd/m            LEDs/each optic 1            Light colour White            Required components:</p>		

### OPTICAL RESULTS (SIMULATED):



LED VERO10  
 FWHM / FWTM 28.9° / 56.9°  
 Efficiency 88 %  
 Peak intensity 2.7 cd/lm  
 LEDs/each optic 1  
 Light colour White  
 Required components:

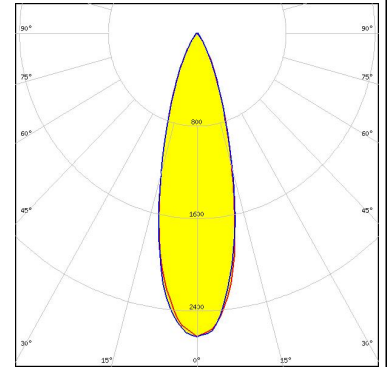

### CITIZEN

LED CLU710/711  
 FWHM / FWTM 54.0° / 88.0°  
 Efficiency 88 %  
 Peak intensity 1 cd/lm  
 LEDs/each optic 1  
 Light colour White  
 Required components:

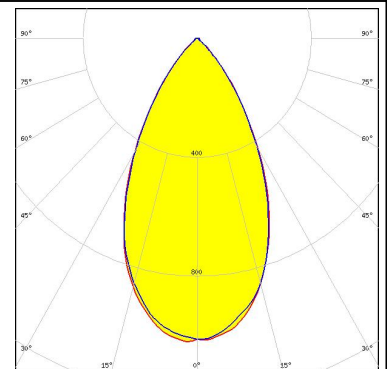

LED LUXEON 5258  
 FWHM / FWTM 16.0° / 31.0°  
 Efficiency 92 %  
 Peak intensity 7.3 cd/lm  
 LEDs/each optic 1  
 Light colour White  
 Required components:

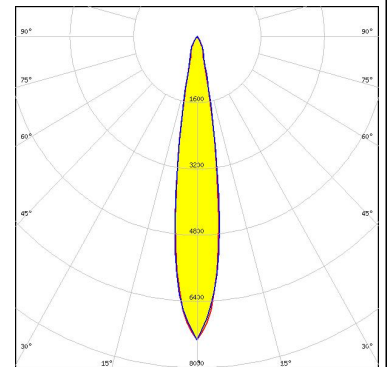

LED LUXEON K4  
 FWHM / FWTM 26.0° / 58.0°  
 Efficiency 86 %  
 Peak intensity 3.2 cd/lm  
 LEDs/each optic 1  
 Light colour White  
 Required components:

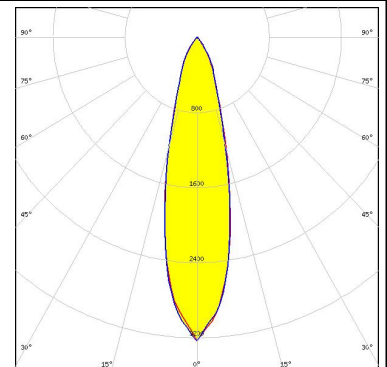

### OPTICAL RESULTS (SIMULATED):

**OSRAM**  
Opto Semiconductors

LED OSCONIQ P 7070  
FWHM / FWTM 31.0° / 67.0°  
Efficiency 92 %  
Peak intensity 2.4 cd/lm  
LEDs/each optic 1  
Light colour White

Required components:

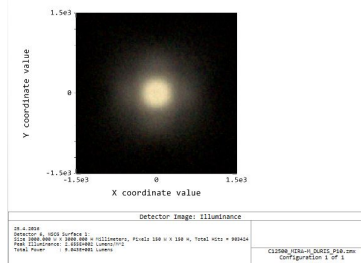

### GENERAL INFORMATION:

NOTE: The typical beam angle will be changed by different color, chip size and chip position tolerance. The typical total beam angle is the full angle measured where the luminous intensity is half of the peak value.

Due to use of high power COB's with this product, special attention to proper thermal design is highly recommended. LEDiL has no liability for direct, indirect or consecutive damages arising from the LEDiL products being used outside of the recommended temperature range.

### MATERIALS:

As part of our continuous research and improvement processes, and to ensure the best possible quality and availability of our products, LEDiL reserves the right to change material grades without notice.

### PRODUCT DATA USER AGREEMENT AND DISCLAIMER:

The measured data in the provided downloadable LEDiL Product Datasheets and Mechanical 2D-Drawings is rounded and provided as reference for planning. LEDiL Oy's optical specifications have been verified by conducting performance testing of the products in accordance with the company's quality system. The reported data are averaged results of multiple measurements with typical variation. LEDiL Oy reserves the right to without prior notification make changes and improvements to its products.

LEDiL Oy assumes neither warranty, nor guarantee nor any other liability of any kind for the contents and correctness of the provided data. The provided data has been generated with highest diligence but the provided data may in reality not represent the complete possible variation range of all intrinsic parameters. Therefore, in certain cases a deviation from the provided data could occur.

LEDiL Oy reserves the right to undertake technical changes of its products without further notification which could lead to changes in the provided data. LEDiL Oy assumes no liability of any kind for the possible deviation from any provided data or any other damage resulting from the usage of the provided data.

The user agrees to this disclaimer and user agreement with the download or usage of the provided files.

#### LEDiL Oy

Joensuunkatu 13  
FI-24240 SALO  
Finland

#### LEDiL Inc.

228 West Page Street  
Suite D  
Sycamore IL 60178  
USA

#### Ledil Optics Technology (Shenzhen) Co., Ltd.

# 405 , Block B  
Casic Motor Building  
Shenzhen 518057  
P.R.CHINA

#### Local sales and technical support

[www.ledil.com/  
where\\_to\\_buy](http://www.ledil.com/where_to_buy)

#### Shipping locations

Salo, Finland  
Hong Kong, China

#### Distribution Partners

[www.ledil.com/  
where\\_to\\_buy](http://www.ledil.com/where_to_buy)