

CEL

1 Mbps, OPEN COLLECTOR OUTPUT, FOR GATE DRIVE INTERFACE HIGH CMR, INTELLIGENT POWER MODULE 5-PIN SOP PHOTOCOUPLER

PS9113**FEATURES**

- **HIGH VCC**
35 V MAX
- **HIGH COMMON MODE TRANSIENT IMMUNITY**
CMH, CML = ± 15 kV/ μ s MIN
- **SMALL PACKAGE**
5-pin SOP
- **HIGH SPEED RESPONSE**
 $t_{PHL} = 500$ ns MAX, $t_{PLH} = 750$ ns MAX
- **PULSE WIDTH DISTORTION**
 $|t_{PHL} - t_{PLH}| = 270$ ns TYP
- **AVAILABLE IN TAPE AND REEL**
PS9113-F3, F4: 2500 pcs/reel

DESCRIPTION

NEC's PS9113 is an optically coupled isolator containing a GaAlAs LED on the input side and a photodiode and a signal processing circuit on the output side on one chip.

APPLICATIONS

- **IPM DRIVER**
- **GENERAL PURPOSE INVERTER**

ELECTRICAL CHARACTERISTICS ($T_A = -40$ to $+100^\circ\text{C}$, $V_{CC} = 15$ V, Unless otherwise specified)

		PART NUMBER			PS9113		
	SYMBOL	PARAMETERS	UNITS	MIN	TYP ¹	MAX	
Diode	V_F	Forward Voltage, $I_F = 10$ mA	V	1.3	1.65	2.1	
	I_R	Reverse Current, $V_R = 3$ V	μ A			200	
	C_t	Terminal Capacitance, $V = 0$, $f = 1$ MHz, $T_A = 25^\circ\text{C}$	pF		30		
Detector	I_{OH}	High Level Output Current $V_{CC} = 30$ V, $V_F = 0.8$ V	μ A		0.01	50	
	V_{OL}	Low Level Output Voltage ² $I_F = 10$ mA, $V_{CC} = 5$ V, $I_{OL} = 2.4$ mA	V		0.13	0.6	
	I_{CCH}	High Level Supply Current, $V_{CC} = 30$ V, $I_F = 0.8$ V, $V_O = \text{open}$	mA		0.6	1.3	
	I_{CCL}	Low Level Supply Current, $V_{CC} = 30$ V, $I_F = 10$ V, $V_O = \text{open}$	mA		0.6	1.3	
Coupled	I_{FHL}	Threshold Input Current, High \rightarrow Low, $V_O = 0.8$ V, $I_O = 0.75$ mA	mA		1.5	5.0	
	CTR	Current Transfer Ratio (I_C/I_F), $I_F = 10$ mA, $V_O = 0.6$ V	%	44	110		
	R_{I-O}	Isolation Resistance, $V_{I-O} = 1$ k Vdc, $R_H = 40$ to 60% , $T_A = 25^\circ\text{C}$	Ω	10^{11}			
	C_{I-O}	Isolation Capacitance, $V = 0$, $f = 1$ MHz, $T_A = 25^\circ\text{C}$	pF		0.6		
	t_{PHL}	Propagation Delay Time ² , High \rightarrow Low $I_F = 10$ mA, $R_L = 20$ k Ω , $C_L = 100$ pF, $V_{THHL} = 1.5$ V, $V_{THLH} = 2.0$ V	ns		250	500	
	t_{PLH}	Propagation Delay Time ² , Low \rightarrow High $I_F = 10$ mA, $R_L = 20$ k Ω , $C_L = 100$ pF, $V_{THHL} = 1.5$ V, $V_{THLH} = 2.0$ V	ns		520	750	
	$t_{PLH-t_{PHL}}$	Maximum Propagation Delays, Low \rightarrow High $I_F = 10$ mA, $R_L = 20$ k Ω , $C_L = 100$ pF, $V_{THHL} = 1.5$ V, $V_{THLH} = 2.0$ V	ns	-200	270	650	

Continued on next page

ELECTRICAL CHARACTERISTICS (TA = -40 to +100°C, VCC = 15 V, Unless otherwise specified), Continued

		PART NUMBER		PS9113		
SYMBOL		PARAMETERS	UNITS	MIN	TYP	MAX
Coupled	tPHL - tPLH	Pulse Width Distortion, (PWD) ³ , VCC = 5 V, RL = 350 Ω, IF = 7.5 mA IF = 10 mA, RL = 20 kΩ, CL = 100 pF, VTHHL = 1.5 V, VTHLH = 2.0 V	ns		270	650
	CMH	Common Mode Transient Immunity at High Level Output ³ , TA = 25°C, IF = 0 mA, VO > 3.0 V, VCM = 1.5 kV, RL = 20 kΩ, CL = 100 pF	kV/μs	15		
	CML	Common Mode Transient Immunity at Low Level Output ³ , TA = 25°C, IF = 10 mA, VO < 1.0 V, VCM = 1.5 kV, RL = 20 kΩ, CL = 100 pF	kV/μs	15		

Notes:

1. Typical values at TA = 25°C.
2. Test Circuit for Propagation delay time

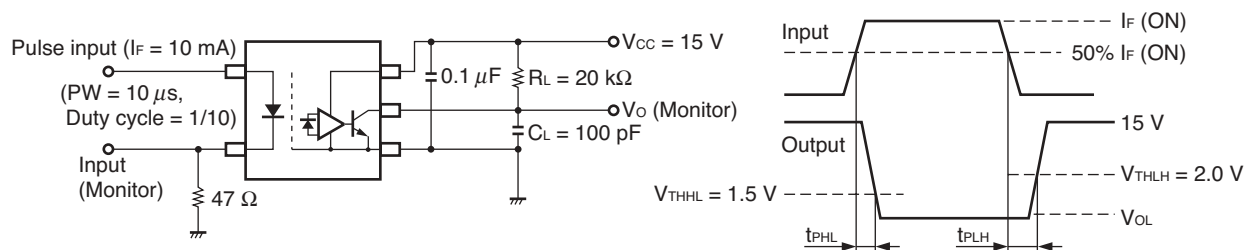

3. Test Circuit for common mode transient immunity

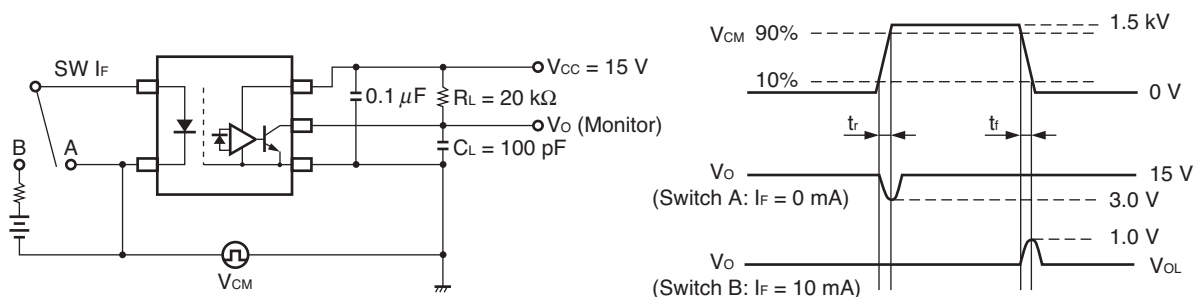

Remark CL includes probe and stray wiring capacitance.

USAGE CAUTIONS

1. This device is ESD sensitive.
2. Bypass capacitor of more than 0.1 μF is used between VCC and GND near device. Also, ensure that the distance between the leads of the photocoupler and capacitor is no more than 10 mm.

FUNCTIONAL DIAGRAM

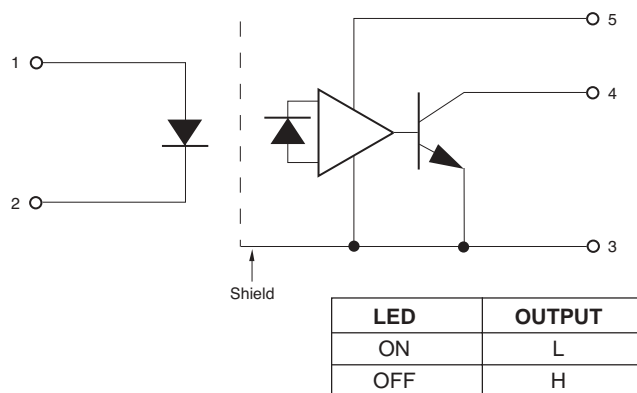

ABSOLUTE MAXIMUM RATINGS¹ (TA = 25°C)

SYMBOLS	PARAMETERS	UNITS	RATINGS
Diode			
IF	Forward Current ²	mA	25
VR	Reverse Voltage	V	5
Detector			
VCC	Supply Voltage	V	-0.5 to +35
VO	Output Voltage	V	-0.5 to +35
IO	Output Current	mA	15
PC	Power Dissipation ³	mW	100
Coupled			
BV	Isolation Voltage ⁴	Vr.m.s.	2500
TA	Operating Temperature	°C	-40 to +100
TSTG	Storage Temperature	°C	-55 to +125

Notes:

1. Operation in excess of any one of these parameters may result in permanent damage.
2. Reduced to 0.33 mA/°C at TA = 70 °C or more.
3. Reduced to 1.9 mW/°C at TA = 70 °C or more.
4. AC voltage for 1 minute at TA = 25 °C, RH = 60% between input and output.

TYPICAL PERFORMANCE CURVES ($T_A = 25^\circ\text{C}$)

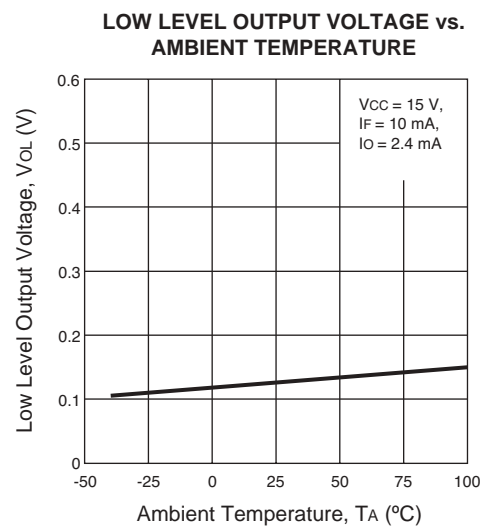
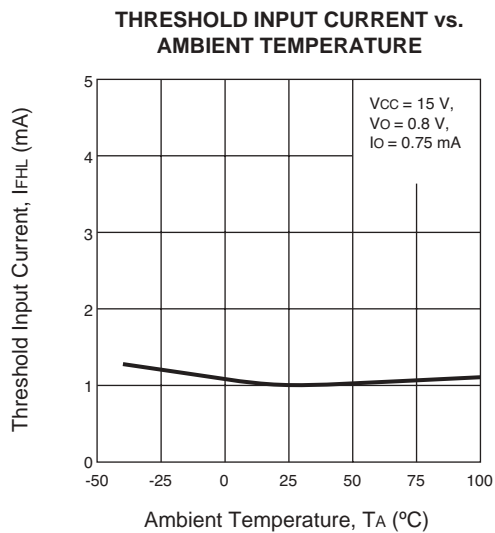
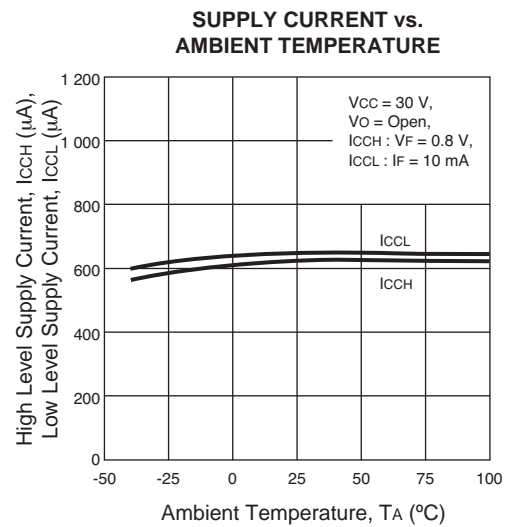
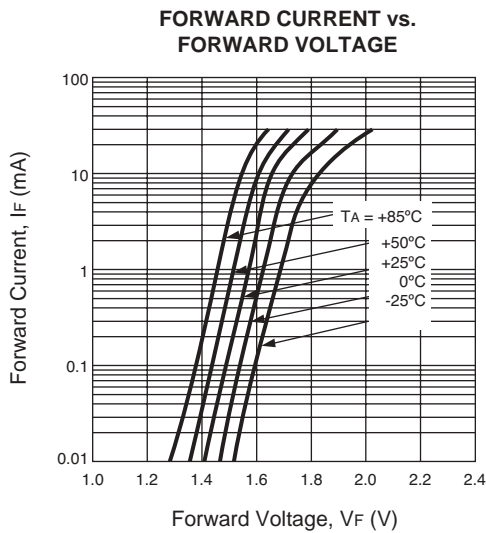
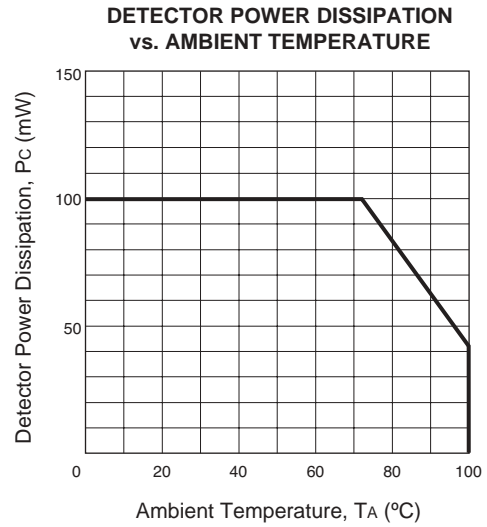
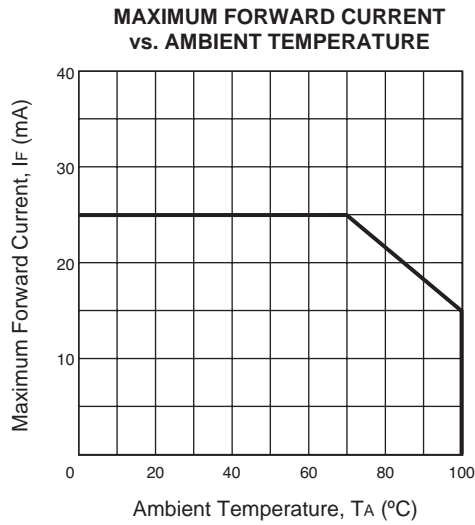

TYPICAL PERFORMANCE CURVES (TA = 25°C)

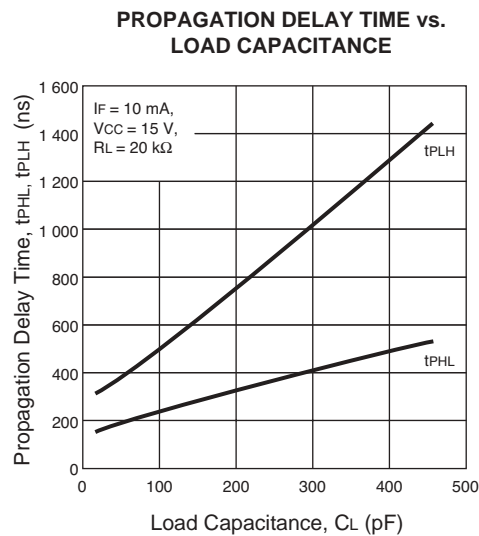
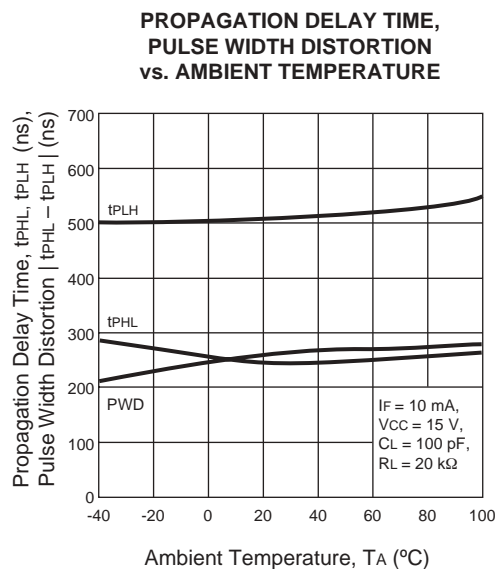
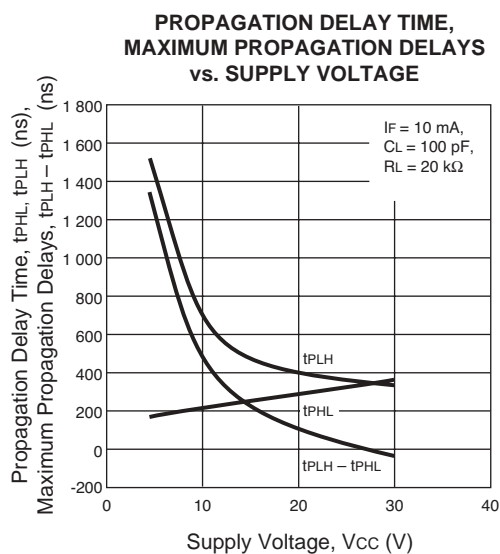
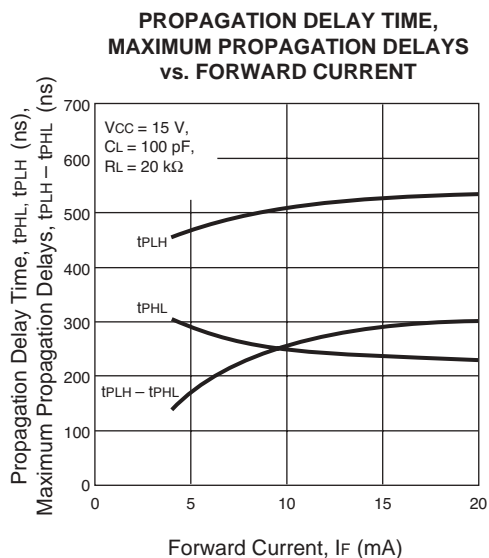
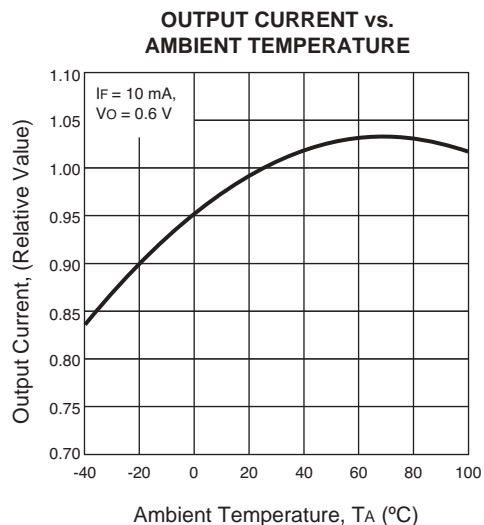
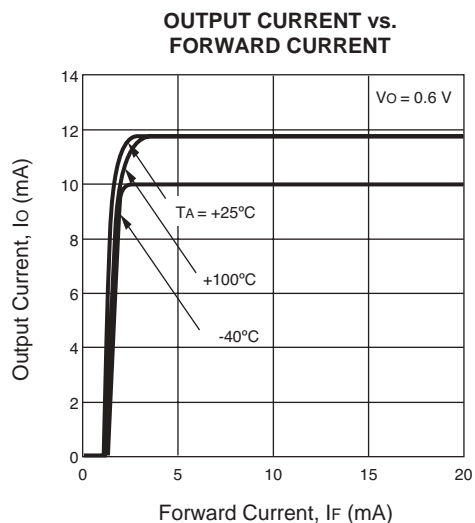

TYPICAL PERFORMANCE CURVES (TA = 25°C)

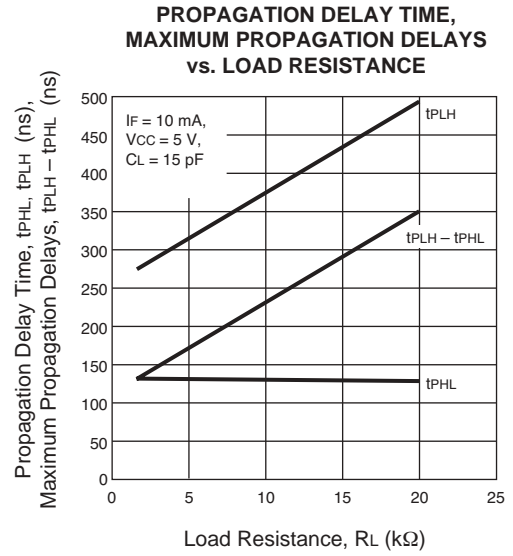
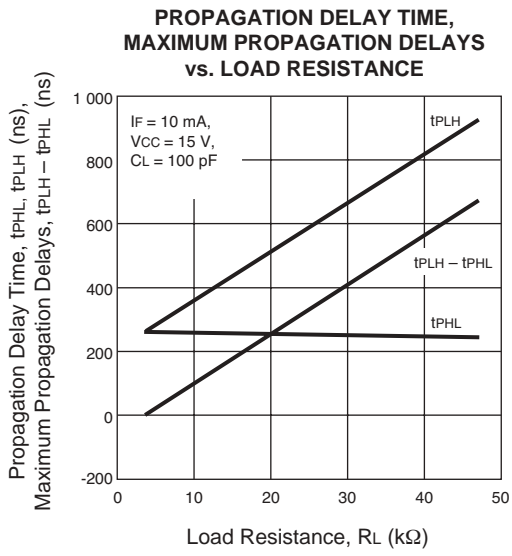

OUTLINE DIMENSIONS (Units in mm)

PS9113

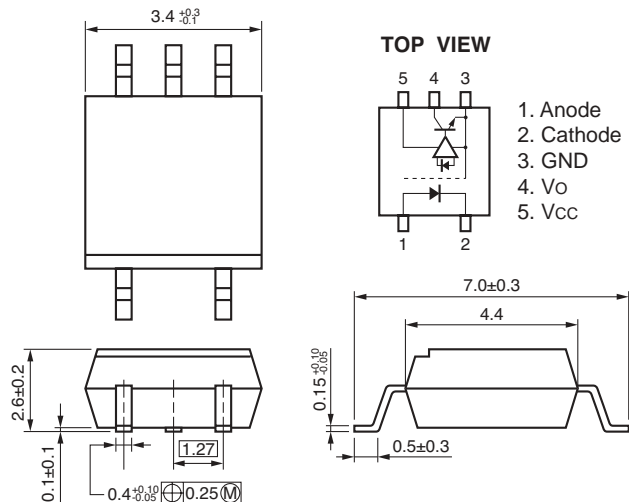

MARKING

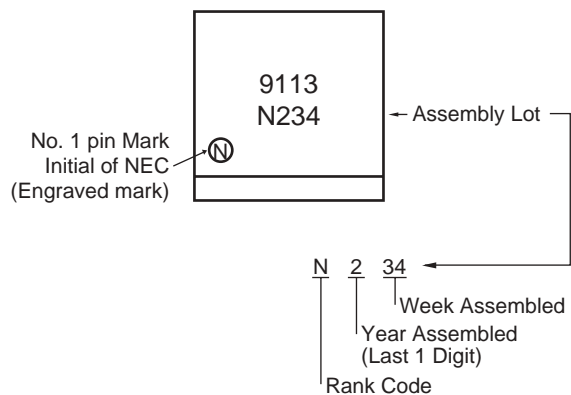

RECOMMENDED OPERATING CONDITIONS

PART NUMBER			PS9113		
SYMBOLS	PARAMETERS	UNITS	MIN	TYP	MAX
IFH	High Level Input Current	mA	10		20
Vo	Output Voltage	V	0		30
Vcc	Supply Voltage	V	4.5		30
Vf	LED Off Voltage	V	0		0.8

ORDERING INFORMATION

PART NUMBER	PACKAGE	PACKAGE STYLE	APPLICATION PART NUMBER*
PS9113	5-pin SOP	Magazine case 100 PCS	PS9113
PS9113-F3		Embossed Tape 2500 pcs/reel	
PS9113-F4			

* For the application of the Safety Standard, following part number should be used.

Life Support Applications

These NEC products are not intended for use in life support devices, appliances, or systems where the malfunction of these products can reasonably be expected to result in personal injury. The customers of CEL using or selling these products for use in such applications do so at their own risk and agree to fully indemnify CEL for all damages resulting from such improper use or sale.

CEL California Eastern Laboratories, Your source for NEC RF, Microwave, Optoelectronic, and Fiber Optic Semiconductor Devices.
4590 Patrick Henry Drive • Santa Clara, CA 95054-1817 • (408) 988-3500 • FAX (408) 988-0279 • www.cel.com

DATA SUBJECT TO CHANGE WITHOUT NOTICE

09/10/2003