

NuWaves

RF Solutions

NuPower™ LS-20-C01-S01 L- & S-Band Solid State Power Amplifier

20 Watt CW
1.0 GHz - 2.5 GHz



P/N: NW-PA-LS-20-C01-S01

(includes NW-PA-ACC-CB09MA interface cable)

The NuPower™ LS-20-C01-S01 is a small, highly efficient solid state power amplifier that provides 20 watts (typ) of RF power to boost performance of data links and transmitters.

Based on the latest gallium nitride (GaN) technology, NuPower's 30% - 50% power efficiency and 3.9 in³ form factor make it ideal for size, weight, and power-constrained broadband RF telemetry and tactical communication systems.

The NuPower LS-20-C01-S01 power amplifier accepts a nominal 0 dBm RF input and provides over 40 dB of gain from 1.0 GHz to 2.5 GHz. The NuPower LS-20-C01-S01 module comes standard with a NW-PA-ACC-CB09MA interface cable, for ease of integration.

NuPower PAs feature over-voltage and reverse-voltage protection and can operate over a wide temperature range of -40 °C to +60 °C.

Extend your operational communication range with NuPower™ amplifiers from NuWaves RF Solutions.

Features

- 20 Watts RF Output Power
- 1.0 GHz to 2.5 GHz
- Miniature Package (3.00" x 2.00" x 0.65")
- High-Efficiency GaN Technology
- 0 dBm Nominal RF Input
- Reverse-Voltage Protection
- Logic On/Off Control

Benefits

- Extended Range
- Improved Link Margin
- Reduced load on DC power budget due to high efficiency operation
- Requires less volume on space-constrained platforms

Applications

- Unmanned Aircraft Systems (UAS), Group 2 & 3
- Unmanned Ground Vehicles (UGV)
- Broadband RF Telemetry
- RF Communication Systems
- Software Defined Radios

NuPower™ LS-20-C01-S01 Power Amplifier

Specifications

Absolute Maximums

Parameter	Rating	Unit
Max Device Voltage	32	V
Max Device Current	2.8	A
Max RF Input Power, $Z_L = 50 \Omega$	10	dBm
Max Operating Temperature (ambient)	60	°C
Max Operating Temperature (baseplate)	85	°C
Max Storage Temperature	85	°C

Export Classification
EAR99

Electrical Specifications @ 28VDC, 25 °C, $Z_S=Z_L=50 \Omega$

Parameter	Symbol	Min	Typ	Max	Unit	Condition
Operating Frequency	BW	1000		2500	MHz	
RF Output Power	P_{SAT}	15	22	30	W	$P_{in} = 0 \text{ dBm}$
Output Power @ 1dB Compression	P1dB		27		dBm	1.0 GHz
			30			1.5 GHz
			33			2.0 GHz
			33			2.5 GHz
Small Signal Gain	G		52		dB	1.0 GHz, @ -30 dBm input
			50			1.5 GHz, @ -30 dBm input
			49			2.0 GHz, @ -30 dBm input
			49			2.5 GHz, @ -30 dBm input
Small Signal Gain Flatness	ΔG		± 2		dB	$P_{in} = -30 \text{ dBm}$
Power Gain Flatness			± 1		dB	$P_{in} = 0 \text{ dBm}$
Input VSWR	VSWR	1.1:1	1.8:1	5:1		
Nominal Input Drive Level	P_{IN}		0		dBm	
Operating Voltage	VDC	11	28	32	V	
Quiescent Current	I_{DQ}		0.610		A	
Operating Current	I_{DD}	1.5	2.1	2.8	A	$P_{in} = 0 \text{ dBm}$
Module Efficiency		29	41	51	%	$P_{in} = 0 \text{ dBm}$
Switching Speed	$TX_{ON/OFF}$			2	μS	10% to 90%
Third Order Intercept Point (Two tone test at 1 MHz spacing, $P_{out} = 20 \text{ dBm / tone}$)	OIP3		42		dBm	1.0 GHz
			42			1.5 GHz
			44			2.0 GHz
			45			2.5 GHz
Harmonics	2nd	-20	-28	-8	dBc	
	3rd	-30	-22	-14		
Output Mismatch w/o Damage				10:1		

NuPower™ LS-20-C01-S01 Power Amplifier

Specifications (cont.)

Mechanical Specifications

Parameter	Value	Unit	Limits
Dimensions	3.0 x 2.0 x 0.65	in	Max
Weight	3	oz	Max
RF Connectors, Input/Output	SMA Female		
Interface Connector	Micro-D, 9-pin Socket		
Cooling	Adequate Heatsink Required		

Environmental Specifications

Parameter	Symbol	Min	Typ	Max	Unit
Operating Temperature (ambient)	T_A	-40		+60	°C
Operating Temperature (baseplate)	T_C	-40		+85	°C
Storage Temperature	T_{STG}	-55		+85	°C
Relative Humidity (non-condensing)	RH			95	%
Altitude MIL-STD-810F - Method 500.4	ALT			30,000	ft
Vibration / Shock Profile (Random profile in x,y, z axis, as per Figure for 15 minute duration in each axis)					

Performance Plots

Test Conditions: +28 VDC, +25 °C, $Z_S=Z_L=50 \Omega$

Power Input vs. Power Output

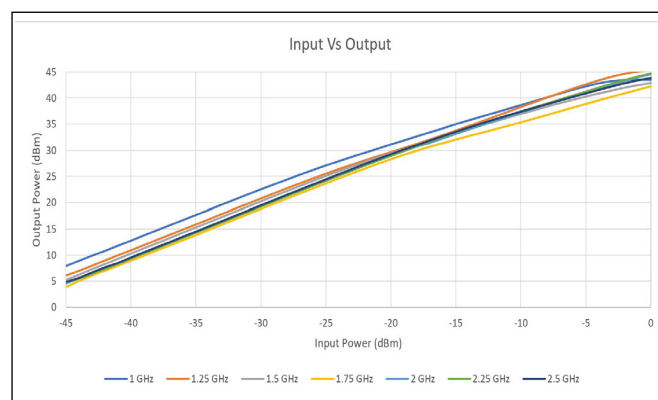

Gain vs. Input Power

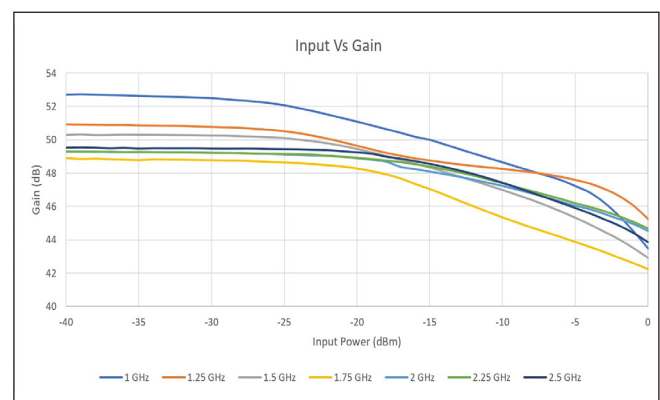

NuPower™ LS-20-C01-S01 Power Amplifier

Performance Plots (cont.)

RF Power @ 0 dBm Input

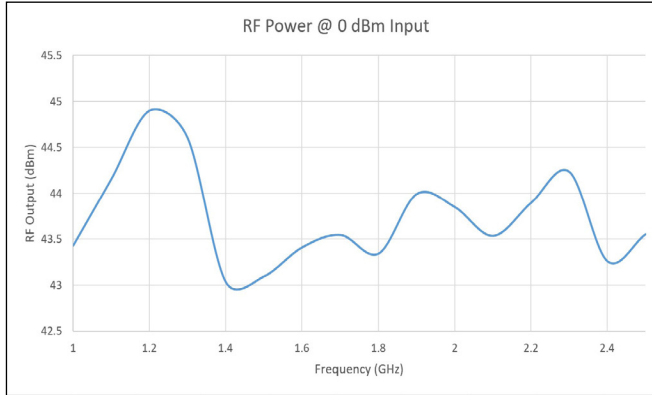

Gain vs. Input Power

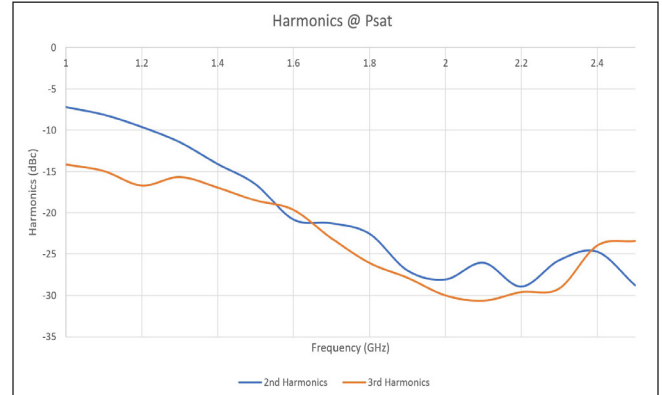

P1dB & P3dB

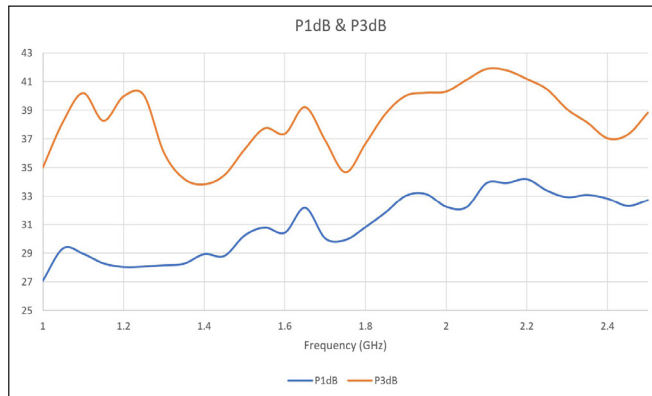

OIP3

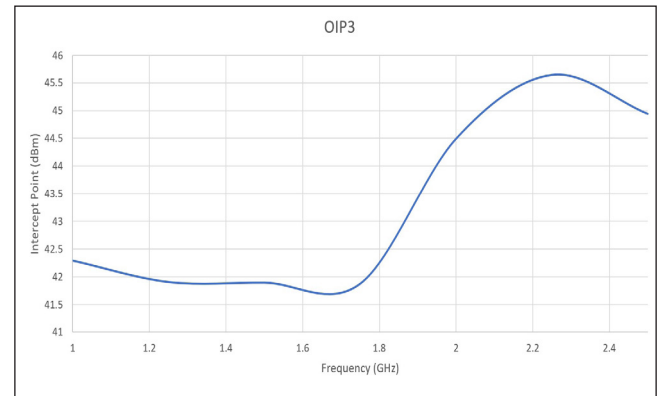

Gain - Stepped Input

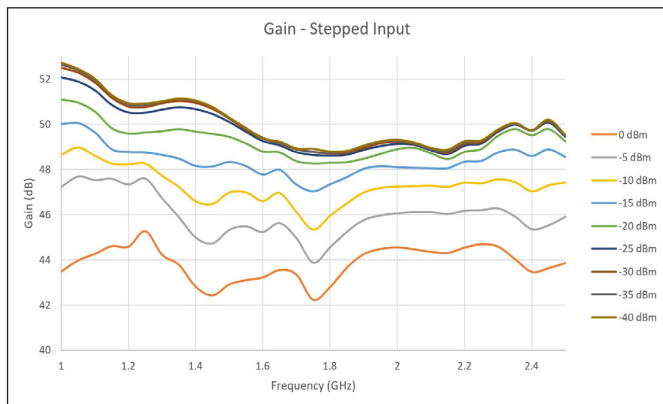

Small Signal Gain (-30 dBm Input)

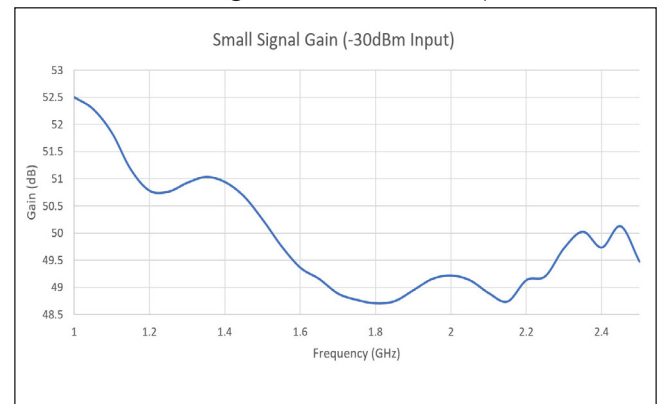

NuPower™ LS-20-C01-S01 Power Amplifier

Performance Plots (cont.)

Current Consumptions +28VDC @ 0 dBm Input

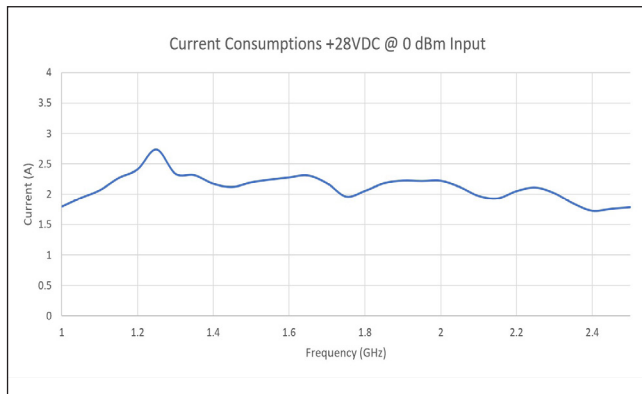

Power Added Efficiency @ 0 dBm Input

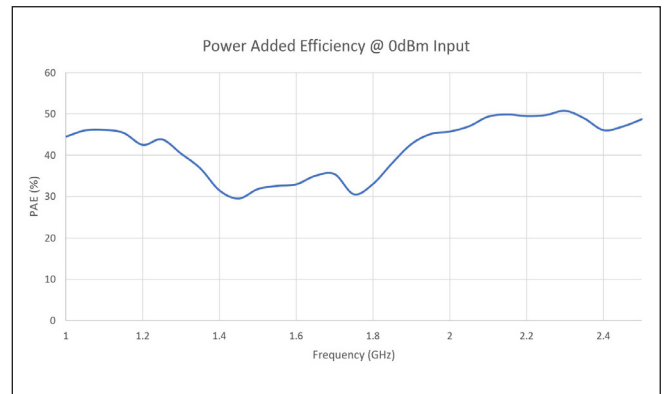

Input VSWR

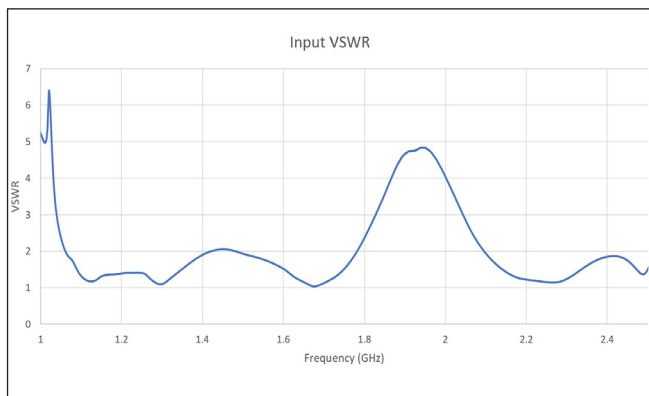

EVM vs. Input Power (16-QAM 2Mps)

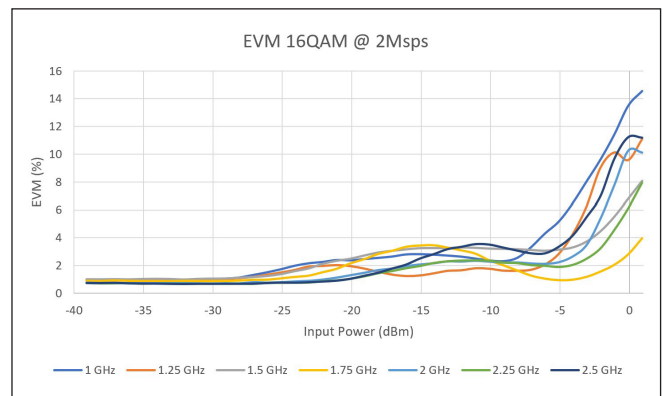

EVM vs. Output Power (16-QAM 2Mps)

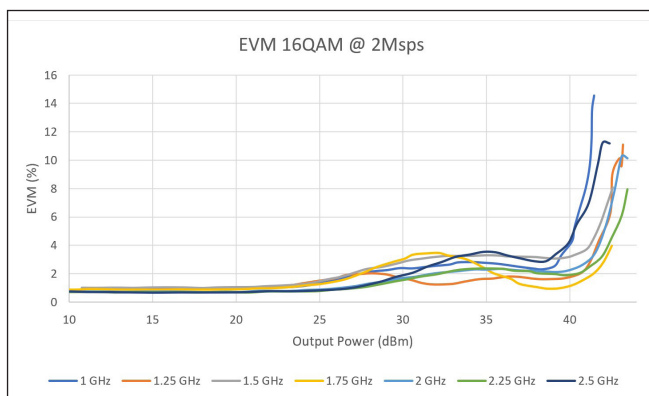

EVM vs. Input Power (32-QAM 2Mps)

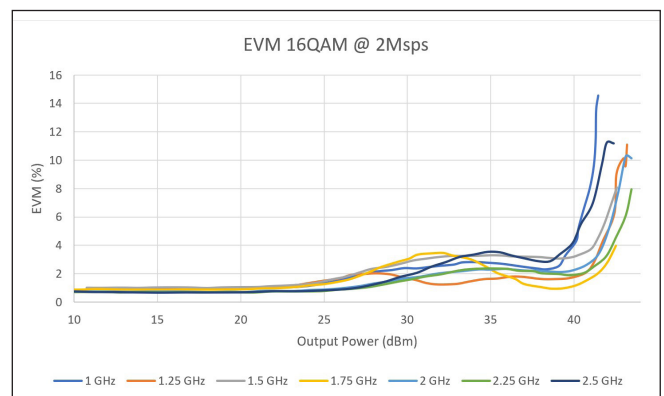

NuPower™ LS-20-C01-S01 Power Amplifier

Performance Plots (cont.)

EVM vs. Output Power (32-QAM 2Msps)

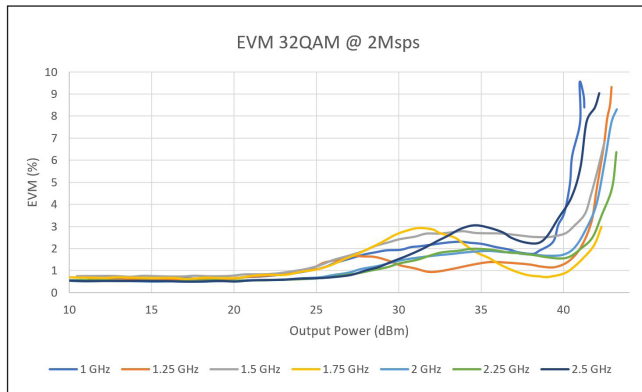

EVM vs. Input Power (64-QAM 2Msps)

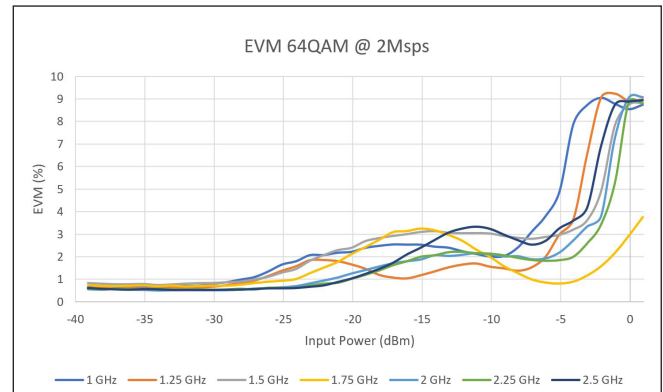

EVM vs. Output Power (64-QAM 2Msps)

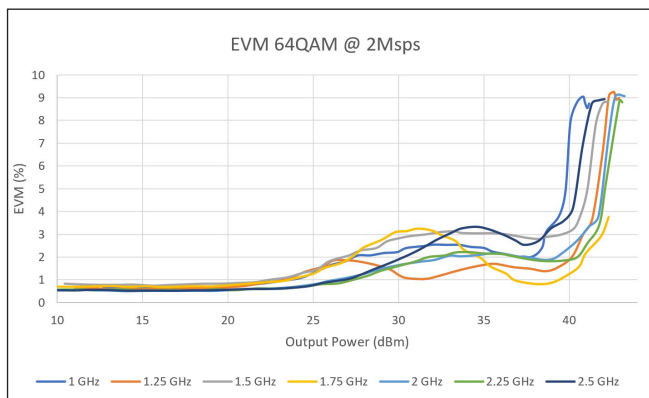

EVM vs. Input Power (QPSK @ 2 Msps)

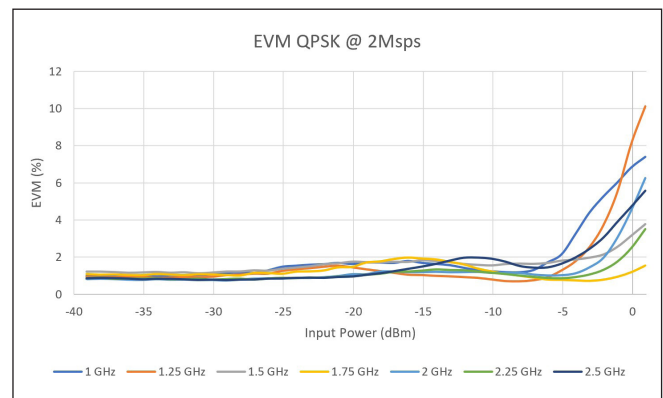

EVM vs. Output Power (QPSK @ 2 Msps)

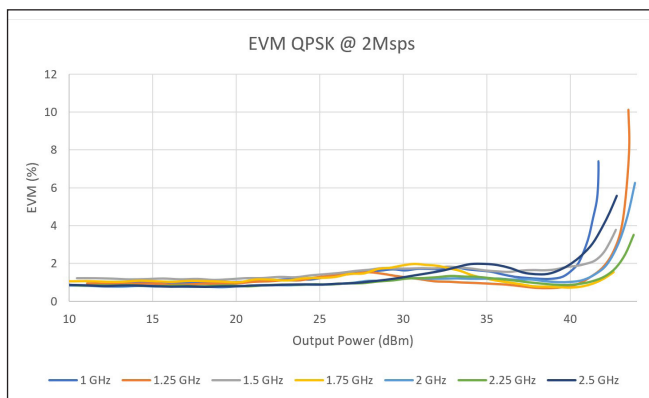

NuPower™ LS-20-C01-S01 Power Amplifier

Mechanical Outline

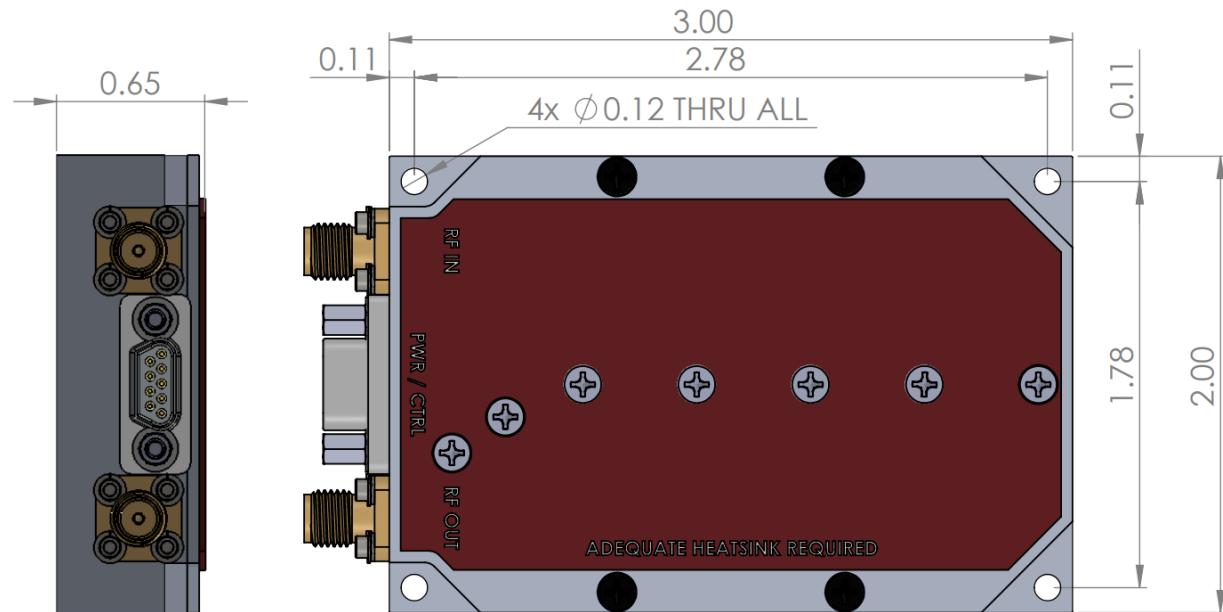

Accessory Part Numbers

Part Number	Description
NW-FL-05LPLE-2500-SFSF-M01	Harmonic Filter Module
NW-PA-ACC-CB09MA	Standard Interface Cable Assembly - Flying Leads (included with module)
NW-PA-ACC-CT09MA	Upgraded Interface Cable Assembly - Banana Plug Termination
NW-PA-ACC-KT01	Accessory Kit, which includes Fan-Cooled Heatsink and Upgraded Interface Cable
NW-PA-ACC-HS01	Heatsink with Integrated Fan

Pinout

Function	I/O	Pin
DC Power (+11 to +32 VDC)	I	1, 2
Ground	I	3, 4
RF Enable 0V or GND = RF ON +5V or NC = RF OFF	I	5
No Connect	-	6, 7, 9
Over Temperature Flag 0V = temperature fault +5V = no fault	O	8

For information on product disposal (end-of-life), please refer to this document:
<https://nuwaves.com/wp-content/uploads/Product-Disposal-End-of-Life.pdf>

Contact NuWaves



NuWaves RF Solutions
 132 Edison Drive
 Middletown, OH 45044

www.nuwaves.com
sales@nuwaves.com
 513.360.0800

