



## AA3528VR41S-W2-AMT

3.5 x 2.8 mm Surface Mount LED Lamp

### DESCRIPTIONS

- The source color devices are made with InGaN Light Emitting Diode
- Electrostatic discharge and power surge could damage the LEDs
- It is recommended to use a wrist band or anti-electrostatic glove when handling the LEDs
- All devices, equipments and machineries must be electrically grounded

### FEATURES

- Single color
- Suitable for all SMD assembly and solder process
- Available on tape and reel
- Ideal for backlighting
- Package: 2000 pcs / reel
- Moisture sensitivity level: 3
- RoHS compliant

### APPLICATIONS

- Traffic signaling
- Backlighting (illuminated advertising , general lighting)
- Interior and exterior automotive lighting
- Substitution of micro incandescent lamps
- Reading lamps
- Signal and symbol luminaire for orientation
- Marker lights (e.g. Steps, exit ways, etc)
- Decorative and entertainment lighting
- Indoor and outdoor commercial and residential architectural lighting

### ATTENTION

Observe precautions for handling electrostatic discharge sensitive devices



### PACKAGE DIMENSIONS

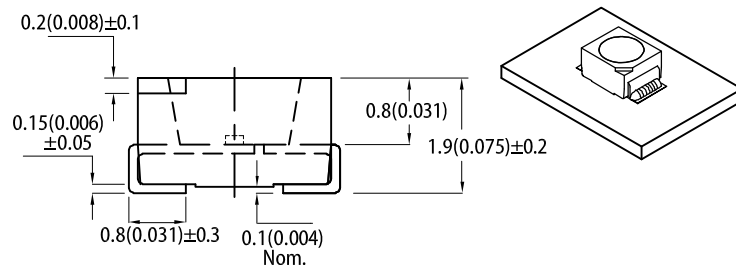
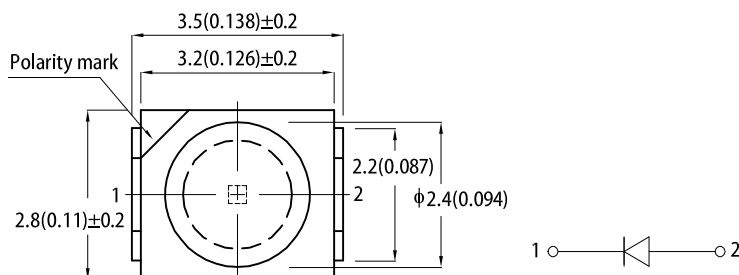

### RECOMMENDED SOLDERING PATTERN

(units : mm; tolerance : ± 0.1)

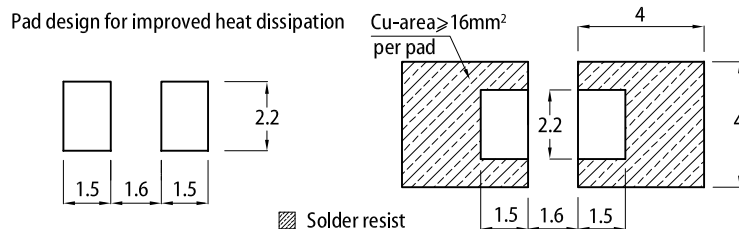

Notes:

1. All dimensions are in millimeters (inches).
2. Tolerance is ±0.25(0.01") unless otherwise noted.
3. The specifications, characteristics and technical data described in the datasheet are subject to change without prior notice.
4. The device has a single mounting surface. The device must be mounted according to the specifications.

### SELECTION GUIDE

Part Number	Emitting Color (Material)	Lens Type	Iv (mcd) @ 20mA <sup>[2]</sup>			Viewing Angle <sup>[1]</sup>
			Code.	Min.	Max.	2θ1/2
AA3528VR41S-W2-AMT	Warm White (InGaN)	Yellow Fluorescent	U	1000	1300	120°
			V	1300	1600	
			W	1600	1900	

Notes:

1. θ1/2 is the angle from optical centerline where the luminous intensity is 1/2 of the optical peak value.
2. Luminous intensity / luminous flux: +/-15%.
3. Luminous intensity value is traceable to CIE127-2007 standards.

**ELECTRICAL / OPTICAL CHARACTERISTICS at T<sub>A</sub>=25°C**

Parameter	Symbol	Emitting Color	Value			Unit
			Min.	Typ.	Max.	
Capacitance	C	Warm White	-	100	-	pF
Forward Voltage I <sub>F</sub> = 20mA	V <sub>F</sub> <sup>[1]</sup>	Warm White	-	3.3	4.0	V
Color Temperature	CCT	Warm White	2870	3000	3220	K
Reverse Current (V <sub>R</sub> = 5V)	I <sub>R</sub>	Warm White	-	-	50	uA
Temperature Coefficient of x I <sub>F</sub> = 20mA, -10°C ≤ T ≤ 100°C	TC <sub>x</sub>	Warm White	-	-0.15	-	10 <sup>-3</sup> /°C
Temperature Coefficient of y I <sub>F</sub> = 20mA, -10°C ≤ T ≤ 100°C	TC <sub>y</sub>	Warm White	-	-0.16	-	10 <sup>-3</sup> /°C
Temperature Coefficient of V <sub>F</sub> I <sub>F</sub> = 20mA, -10°C ≤ T ≤ 100°C	TC <sub>V</sub>	Warm White	-	-3.0	-	mV/°C

## Notes:

1. Forward voltage: ±0.1V.
2. Excess driving current and / or operating temperature higher than recommended conditions may result in severe light degradation or premature failure.

**ABSOLUTE MAXIMUM RATINGS at T<sub>A</sub>=25°C**

Parameter	Symbol	Value	Unit
Power Dissipation	P <sub>D</sub>	120	mW
Reverse Voltage	V <sub>R</sub>	5	V
Junction Temperature	T <sub>j</sub>	115	°C
Operating Temperature	T <sub>op</sub>	-40 to +100	°C
Storage Temperature	T <sub>stg</sub>	-40 to +110	°C
DC Forward Current	I <sub>F</sub>	30	mA
Peak Forward Current	I <sub>FM</sub> <sup>[1]</sup>	100	mA
Electrostatic Discharge Threshold (HBM)	-	250	V
Thermal Resistance (Junction / Ambient)	R <sub>th JA</sub> <sup>[2]</sup>	210	°C/W
Thermal Resistance (Junction / Solder point)	R <sub>th JS</sub> <sup>[2]</sup>	110	°C/W

## Notes:

1. 1/10 Duty Cycle, 0.1ms Pulse Width.
2. R<sub>th JA</sub>, R<sub>th JS</sub> Results from mounting on PC board FR4 (pad size ≥ 16 mm<sup>2</sup> per pad).
3. Relative humidity levels maintained between 40% and 60% in production area are recommended to avoid the build-up of static electricity – Ref JEDEC/JESD625-A and JEDEC/J-STD-033.

### TECHNICAL DATA

#### SPATIAL DISTRIBUTION

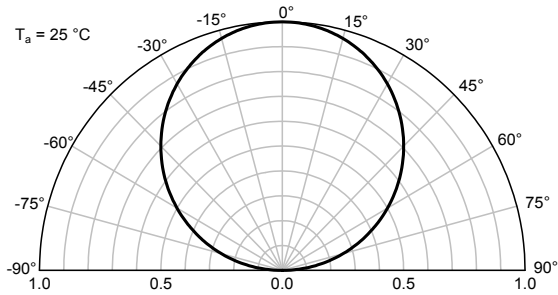

### WARM WHITE

**Forward Current vs. Forward Voltage**

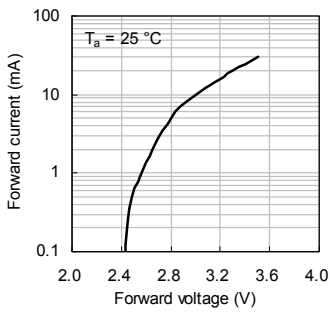

**Luminous Intensity vs. Forward Current**

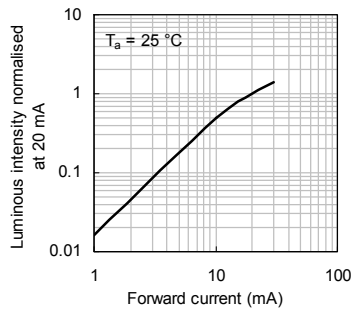

**Forward Current Derating Curve**

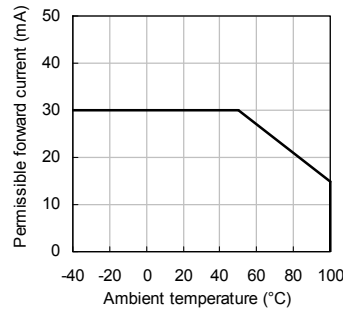

**Luminous Intensity vs. Ambient Temperature**

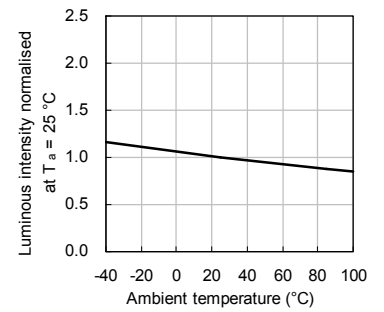

#### REFLOW SOLDERING PROFILE for LEAD-FREE SMD PROCESS

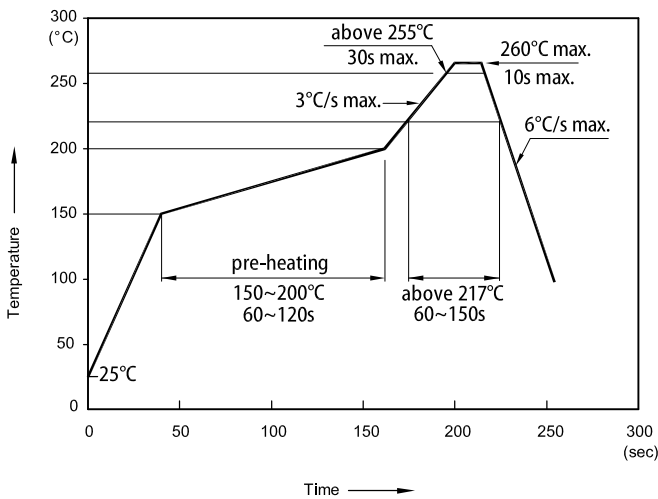

- Notes:
1. Don't cause stress to the LEDs while it is exposed to high temperature.
  2. The maximum number of reflow soldering passes is 2 times.
  3. Reflow soldering is recommended. Other soldering methods are not recommended as they might cause damage to the product.

#### TAPE SPECIFICATIONS (units : mm)

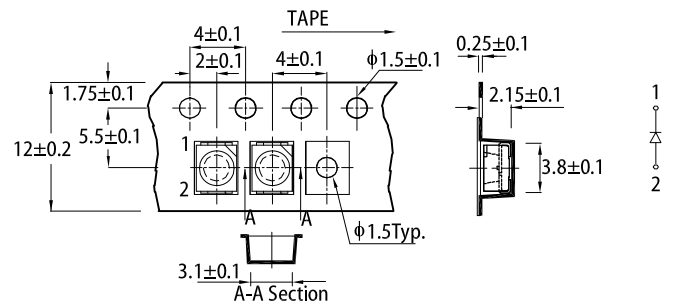

#### REEL DIMENSION (units : mm)

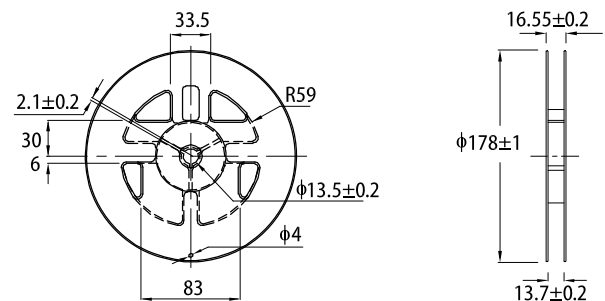

### CIE CHROMATICITY DIAGRAM

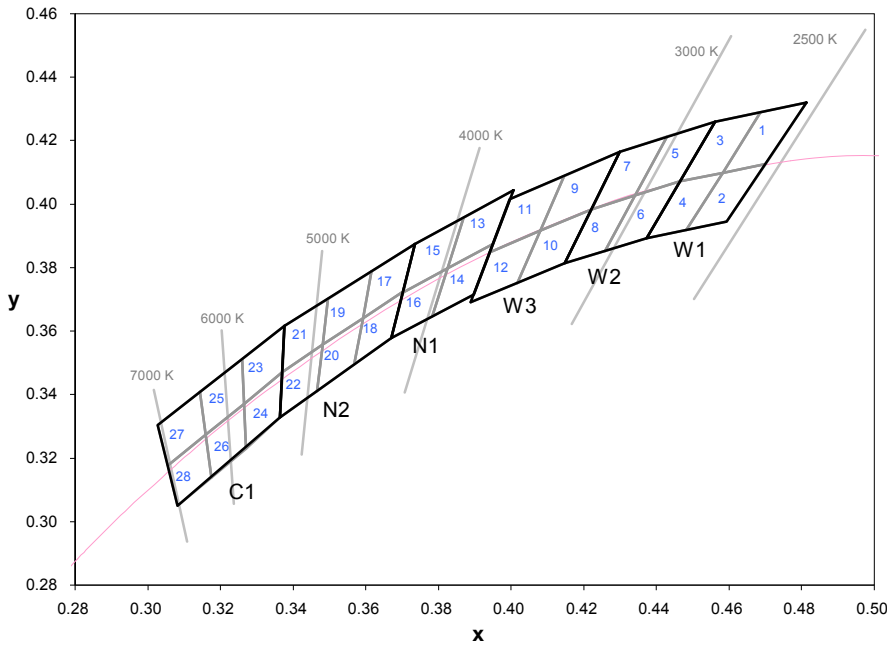

Group	Chromaticity Regions	CCT (K)		
		Min.	Typ.	Max.
W1	1, 2, 3, 4	2580	2700	2870
W2	5, 6, 7, 8	2870	3000	3220
W3	9, 10, 11, 12	3220	3500	3710

Group	Chromaticity Regions	CCT (K)		
		Min.	Typ.	Max.
N1	13, 14, 15, 16	3710	4000	4260
N2	17, 18, 19, 20, 21, 22	4260	4700	5310
C1	23, 24, 25, 26, 27, 28	5310	6000	7040

Notes:  
 Shipment may contain more than one chromaticity regions.  
 Orders for single chromaticity region are generally not accepted.  
 Measurement tolerance of the chromaticity coordinates is  $\pm 0.01$ .

	x	y		x	y		x	y		x	y
1	0.4582	0.4099	8	0.4147	0.3814	15	0.3702	0.3722	22	0.3481	0.3557
	0.4687	0.4289		0.4221	0.3984		0.3736	0.3874		0.3370	0.3472
	0.4813	0.4319		0.4342	0.4028		0.3869	0.3958		0.3364	0.3328
	0.4700	0.4126		0.4259	0.3853		0.3825	0.3798		0.3466	0.3411
2	0.4483	0.3919	9	0.4080	0.3916	16	0.3670	0.3578	23	0.3376	0.3616
	0.4582	0.4099		0.4146	0.4089		0.3702	0.3722		0.3260	0.3512
	0.4700	0.4126		0.4299	0.4165		0.3825	0.3798		0.3265	0.3371
	0.4593	0.3944		0.4221	0.3984		0.3783	0.3646		0.3370	0.3472
3	0.4465	0.4071	10	0.4017	0.3751	17	0.3736	0.3874	24	0.3370	0.3472
	0.4562	0.4260		0.4080	0.3916		0.3616	0.3788		0.3265	0.3371
	0.4687	0.4289		0.4221	0.3984		0.3592	0.3641		0.3270	0.3230
	0.4582	0.4099		0.4147	0.3814		0.3703	0.3726		0.3364	0.3328
4	0.4373	0.3893	11	0.3941	0.3848	18	0.3703	0.3726	25	0.3260	0.3512
	0.4465	0.4071		0.3996	0.4015		0.3592	0.3641		0.3144	0.3408
	0.4582	0.4099		0.4146	0.4089		0.3568	0.3495		0.3160	0.3274
	0.4483	0.3919		0.4080	0.3916		0.3670	0.3578		0.3265	0.3371
5	0.4342	0.4028	12	0.3889	0.3690	19	0.3616	0.3788	26	0.3265	0.3371
	0.4430	0.4212		0.3941	0.3848		0.3496	0.3702		0.3160	0.3274
	0.4562	0.4260		0.4080	0.3916		0.3481	0.3557		0.3175	0.3139
	0.4465	0.4071		0.4017	0.3751		0.3592	0.3641		0.3270	0.3230
6	0.4259	0.3853	13	0.3825	0.3798	20	0.3592	0.3641	27	0.3144	0.3408
	0.4342	0.4028		0.3869	0.3958		0.3481	0.3557		0.3028	0.3304
	0.4465	0.4071		0.4006	0.4044		0.3466	0.3411		0.3055	0.3177
	0.4373	0.3893		0.3950	0.3875		0.3568	0.3495		0.3160	0.3274
7	0.4221	0.3984	14	0.3783	0.3646	21	0.3496	0.3702	28	0.3160	0.3274
	0.4299	0.4165		0.3825	0.3798		0.3376	0.3616		0.3055	0.3177
	0.4430	0.4212		0.3950	0.3875		0.3370	0.3472		0.3081	0.3049
	0.4342	0.4028		0.3898	0.3716		0.3481	0.3557		0.3175	0.3139

**RELIABILITY TEST ITEMS AND CONDITIONS**

The reliability of products shall be satisfied with items listed below

**LOT TOLERANCE PERCENT DEFECTIVE (LTPD) : 10%**

No.	Test Item	Standards	Test Condition	Test Times / Cycles	Number of Damaged
1	Continuous operating test	-	$T_a = 25^{\circ}\text{C}$ , $I_F = \text{maximum rated current} *$	1,000 h	0 / 22
2	High Temp. operating test	EIAJ ED-4701/100(101)	$T_a = 100^{\circ}\text{C}$ , $I_F = \text{maximum rated current} *$	1,000 h	0 / 22
3	Low Temp. operating test	-	$T_a = -40^{\circ}\text{C}$ , $I_F = \text{maximum rated current} *$	1,000 h	0 / 22
4	High temp. storage test	EIAJ ED-4701/100(201)	$T_a = \text{maximum rated storage temperature}$	1,000 h	0 / 22
5	Low temp. storage test	EIAJ ED-4701/100(202)	$T_a = -40^{\circ}\text{C}$	1,000 h	0 / 22
6	High temp. & humidity storage test	-	$T_a = 60^{\circ}\text{C}$ , RH = 90%	500 h	0 / 22
7	High temp. & humidity operating test	-	$T_a = 60^{\circ}\text{C}$ , RH = 90% $I_F = \text{maximum rated current} *$	500 h	0 / 22
8	Soldering reliability test	EIAJ ED-4701/100(301)	Moisture soak: $30^{\circ}\text{C}$ , 70% RH, 72h Preheat: $150\sim 180^{\circ}\text{C}$ (120s max.) Soldering temp: $260^{\circ}\text{C}$ (10s)	2 times	0 / 18
9	Thermal shock operating test	-	$T_a = -40^{\circ}\text{C}$ (15min) ~ $100^{\circ}\text{C}$ (15min) $I_F = \text{derated current at } 100^{\circ}\text{C}$	1,000 cycles	0 / 22
10	Thermal shock test	-	$T_a = -40^{\circ}\text{C}$ (15min) ~ maximum rated storage temperature(15min)	1,000 cycles	0 / 22
11	Electric Static Discharge (ESD)	EIAJ ED-4701/100(304)	$C = 100\text{pF}$ , $R_2 = 1.5\text{K}\Omega$ $V = 250\text{V}$	Once each Polarity	0 / 22
12	Vibration test	-	$a = 196\text{m/s}^2$ , $f = 100\sim 2\text{KHz}$ , $t = 48\text{min}$ for all xyz axes	4 times	0 / 22

\*: Refer to forward current vs. derating curve diagram

**CRITERIA FOR JUDGING DAMAGE**

Items	Symbols	Conditions	Failure Criteria
luminous Intensity	$I_V$	$I_F = 20\text{mA}$	Testing Min. Value < Spec. Min. Value x 0.5
Forward Voltage	$V_F$	$I_F = 20\text{mA}$	Testing Max. Value $\geq$ Spec. Max. Value x 1.2
Reverse Current	$I_R$	$V_R = \text{Maximum Rated Reverse Voltage}$	Testing Max. Value $\geq$ Spec. Max. Value x 2.5
High temp. storage test	-	-	Occurrence of notable decoloration, deformation and cracking

### PACKING & LABEL SPECIFICATIONS

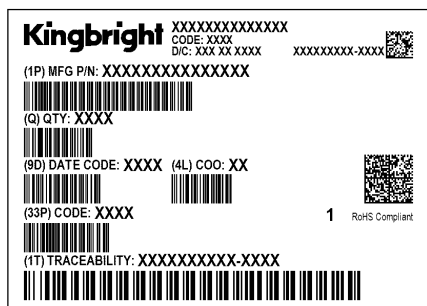
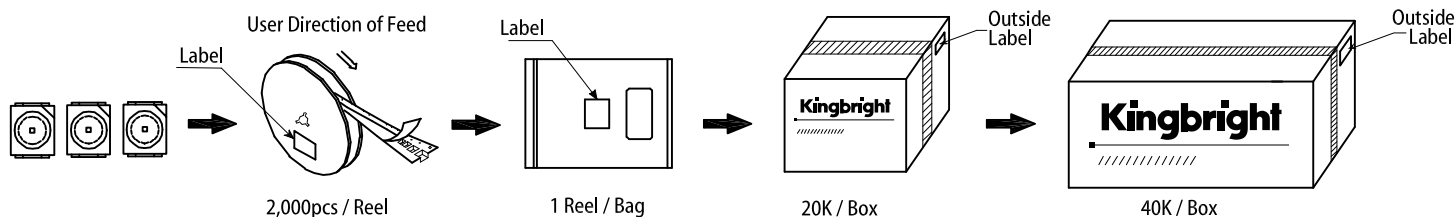

### HANDLING PRECAUTIONS

Compare to epoxy encapsulant that is hard and brittle, silicone is softer and flexible. Although its characteristic significantly reduces thermal stress, it is more susceptible to damage by external mechanical force. As a result, special handling precautions need to be observed during assembly using silicone encapsulated LED products. Failure to comply might lead to damage and premature failure of the LED.

1. Handle the component along the side surfaces by using forceps or appropriate tools.
2. Do not directly touch or handle the silicone lens surface. It may damage the internal circuitry.
3. Do not stack together assembled PCBs containing exposed LEDs. Impact may scratch the silicone lens or damage the internal circuitry.

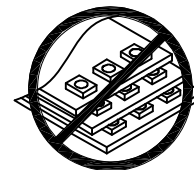
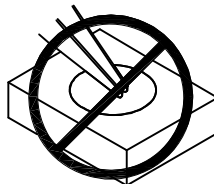
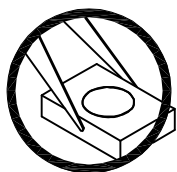

- 4-1. The inner diameter of the SMD pickup nozzle should not exceed the size of the LED to prevent air leaks.
- 4-2. A pliable material is suggested for the nozzle tip to avoid scratching or damaging the LED surface during pickup.
- 4-3. The dimensions of the component must be accurately programmed in the pick-and-place machine to insure precise pickup and avoid damage during production.
5. As silicone encapsulation is permeable to gases, some corrosive substances such as H<sub>2</sub>S might corrode silver plating of lead frame. Special care should be taken if an LED with silicone encapsulation is to be used near such substances.

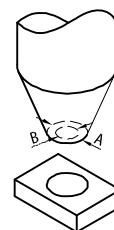

### PRECAUTIONARY NOTES

1. The information included in this document reflects representative usage scenarios and is intended for technical reference only.
2. The part number, type, and specifications mentioned in this document are subject to future change and improvement without notice. Before production usage customer should refer to the latest datasheet for the updated specifications.
3. When using the products referenced in this document, please make sure the product is being operated within the environmental and electrical limits specified in the datasheet. If customer usage exceeds the specified limits, Kingbright will not be responsible for any subsequent issues.
4. The information in this document applies to typical usage in consumer electronics applications. If customer's application has special reliability requirements or have life-threatening liabilities, such as automotive or medical usage, please consult with Kingbright representative for further assistance.
5. The contents and information of this document may not be reproduced or re-transmitted without permission by Kingbright.
6. All design applications should refer to Kingbright application notes available at <http://www.KingbrightUSA.com/ApplicationNotes>