



STB80PF55 STP80PF55

P-channel 55 V, 0.016 Ω , 80 A TO-220, D²PAK
STripFET™ II Power MOSFET

Features

Type	V _{DSS}	R _{DS(on)}	I _D
STP80PF55	55V	<0.018 Ω	80A
STB80PF55	55V	<0.018 Ω	80A

- Extremely dv/dt capability
- 100% avalanche tested
- Application oriented characterization

Application

- Switching applications

Description

These Power MOSFETs are the latest development of STMicroelectronics unique "single feature size" strip-based process. The resulting transistor shows extremely high packing density for low on-resistance, rugged avalanche characteristics and less critical alignment steps allowing remarkable manufacturing reproducibility.

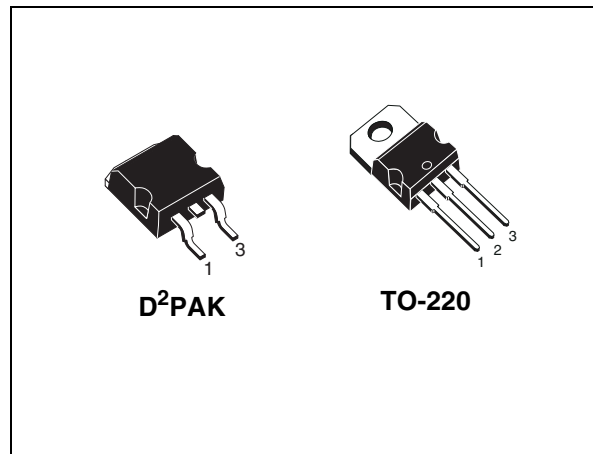

Figure 1. Internal schematic diagram

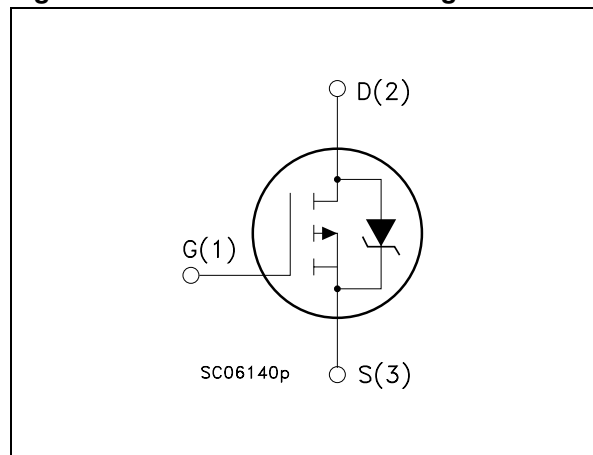

Table 1. Device summary

Order code	Marking	Package	Packaging
STP80PF55	P80PF55	TO-220	Tube
STB80PF55	B80PF55	D ² PAK	Tape and reel

Contents

1	Electrical ratings	3
2	Electrical characteristics	4
	2.1 Electrical characteristics (curves)	6
3	Test circuits	8
4	Package mechanical data	9
5	Packaging mechanical data	14
6	Revision history	15

1 Electrical ratings

Table 2. Absolute maximum ratings

Symbol	Parameter	Value	Unit
V_{DS}	Drain-source voltage ($V_{GS} = 0$)	55	V
V_{GS}	Gate-source voltage	± 16	V
$I_D^{(1)}$	Drain current (continuous) at $T_C = 25^\circ\text{C}$	80	A
I_D	Drain current (continuous) at $T_C = 100^\circ\text{C}$	57	A
$I_{DM}^{(2)}$	Drain current (pulsed)	320	A
P_{TOT}	Total dissipation at $T_C = 25^\circ\text{C}$	300	W
	Derating factor	2	W/ $^\circ\text{C}$
$dv/dt^{(3)}$	Peak diode recovery voltage slope	7	V/ns
$E_{AS}^{(4)}$	Single pulse avalanche energy	1.4	J
T_j	Operating junction temperature	-55 to 175	$^\circ\text{C}$
T_{stg}	Storage temperature		

1. Current limited by package.
2. Pulse width limited by safe operating area .
3. $I_{SD} \leq 40\text{A}$, $di/dt \leq 300\text{ A}/\mu\text{s}$, $V_{DD} = 80\% V_{(BR)DSS}$.
4. Starting $T_j = 25^\circ\text{C}$, $I_D = 80\text{A}$, $V_{DD} = 40\text{V}$.

Table 3. Thermal data

Symbol	Parameter	Value	Unit
$R_{thj-case}$	Thermal resistance junction-case max	0.5	$^\circ\text{C}/\text{W}$
R_{thj-a}	Thermal resistance junction-ambient max	62.5	$^\circ\text{C}/\text{W}$
T_l	Maximum lead temperature for soldering purpose	300	$^\circ\text{C}$

Note: For the P-CHANNEL MOSFET actual polarity of voltages and current has to be reversed

2 Electrical characteristics

($T_{CASE}=25^{\circ}C$ unless otherwise specified)

Table 4. On/off states

Symbol	Parameter	Test conditions	Min.	Typ.	Max.	Unit
$V_{(BR)DSS}$	Drain-source breakdown voltage	$I_D = 250 \text{ mA}, V_{GS} = 0$	55			V
I_{DSS}	Zero gate voltage drain current ($V_{GS} = 0$)	$V_{DS} = \text{Max rating}$ $V_{DS} = \text{Max rating}, T_C=125^{\circ}C$			1 10	μA μA
I_{GSS}	Gate-body leakage current ($V_{DS} = 0$)	$V_{GS} = \pm 16 \text{ V}$			± 10	μA
$V_{GS(th)}$	Gate threshold voltage	$V_{DS} = V_{GS}, I_D = 250 \mu\text{A}$	2	3	4	V
$R_{DS(on)}$	Static drain-source on resistance	$V_{GS} = 10 \text{ V}, I_D = 40 \text{ A}$		0.016	0.018	Ω

Table 5. Dynamic

Symbol	Parameter	Test conditions	Min.	Typ.	Max.	Unit
g_{fs}	Forward transconductance	$V_{DS} > I_{D(on)} \times R_{DS(on)max},$ $I_D = 40 \text{ A}$	-	32		S
C_{iss} C_{oss} C_{rss}	Input capacitance Output capacitance Reverse transfer capacitance	$V_{DS} = 25 \text{ V}, f = 1\text{MHz},$ $V_{GS} = 0$	-	5500 1130 600		pF pF pF
Q_g Q_{gs} Q_{gd}	Total gate charge Gate-source charge Gate-drain charge	$I_D = 25 \text{ A}, V_{DD} = 80 \text{ V},$ $V_{GS} = 10 \text{ V}$ <i>(see Figure 15)</i>	-	190 27 65	258	nC nC nC

Table 6. Switching times

Symbol	Parameter	Test conditions	Min.	Typ.	Max.	Unit
$t_{d(on)}$ t_r	Turn-on delay time Rise time	$V_{DD}=25 \text{ V}, I_D=40 \text{ A},$ $R_G=4.7 \Omega, V_{GS}=10 \text{ V}$ <i>(see Figure 14)</i>	-	35 190	-	ns ns
$t_{d(off)}$ t_f	Turn-off delay time Fall time	$V_{DD}=25 \text{ V}, I_D=40 \text{ A},$ $R_G=4.7 \Omega, V_{GS}=10 \text{ V}$ <i>(see Figure 14)</i>	-	165 80	-	ns ns
$t_{r(Voff)}$ t_f t_c	Off-voltage rise time Fall time Cross-over time	$V_{clamp}=40 \text{ V}, I_D=80 \text{ A},$ $R_G=4.7 \Omega, V_{GS}=10 \text{ V}$ <i>(see Figure 14)</i>	-	60 40 85	-	ns ns ns

Table 7. Source drain diode

Symbol	Parameter	Test conditions	Min.	Typ.	Max.	Unit
I_{SD}	Source-drain current		-		10	A
$I_{SDM}^{(1)}$	Source-drain current (pulsed)		-		40	A
$V_{SD}^{(2)}$	Forward on voltage	$I_{SD} = 80 \text{ A}, V_{GS} = 0$	-		1.6	V
t_{rr}	Reverse recovery time	$I_{SD} = 80 \text{ A}, di/dt = 100 \text{ A}/\mu\text{s}$ $V_{DD} = 25 \text{ V}, T_j = 150 \text{ }^\circ\text{C}$	-	110		ns
Q_{rr}	Reverse recovery charge			495		μC
I_{RRM}	Reverse recovery current			9		A

1. Pulse width limited by T_{jmax} .

2. Pulsed: pulse duration = 300 μs , duty cycle 1.5 %.

Note: For the P-CHANNEL MOSFET actual polarity of voltages and current has to be reversed

2.1 Electrical characteristics (curves)

Figure 2. Safe operating area for TO-220 and D²PAK

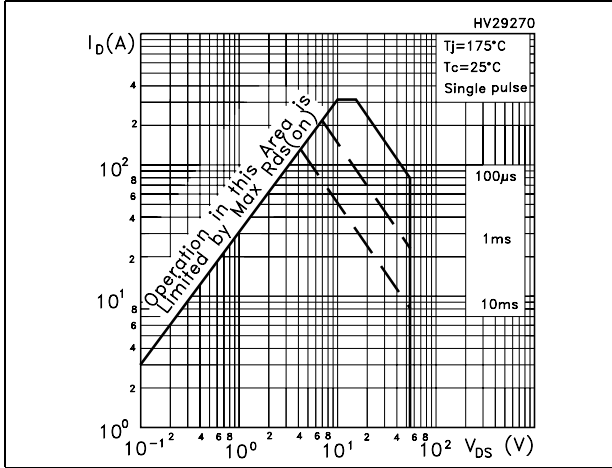

Figure 3. Thermal impedance for TO-220 and D²PAK

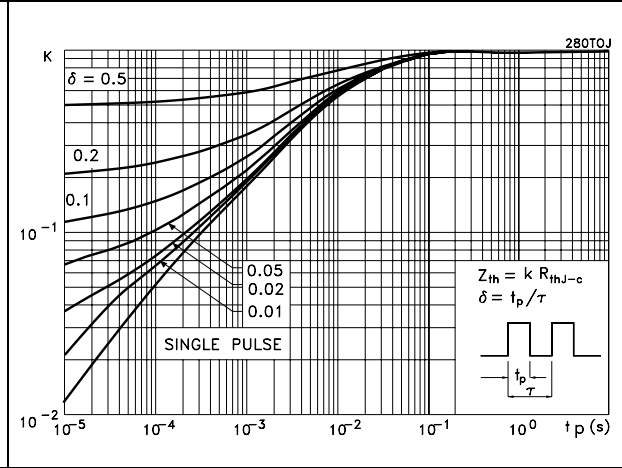

Figure 4. Output characteristics

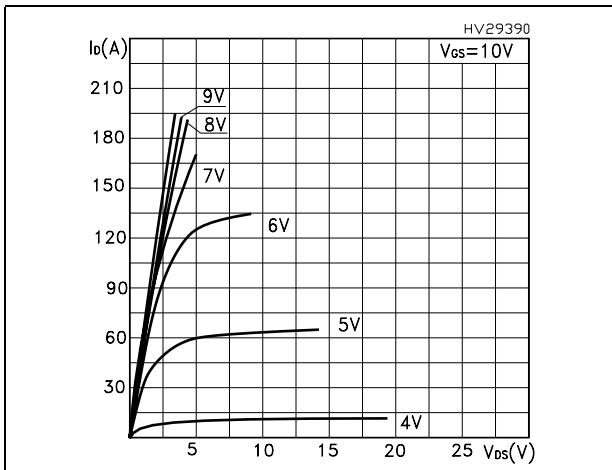

Figure 5. Transfer characteristics

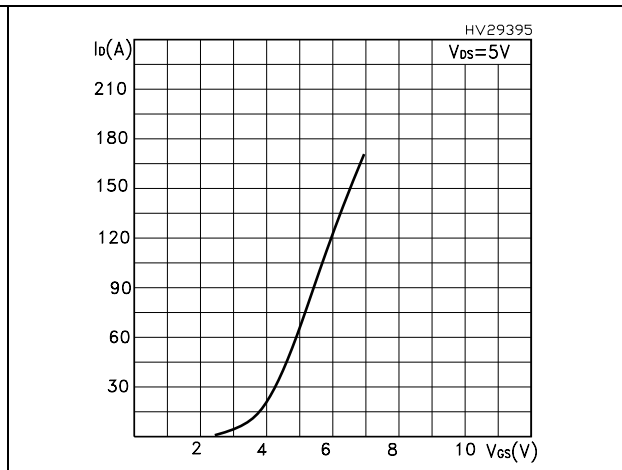

Figure 6. Transconductance

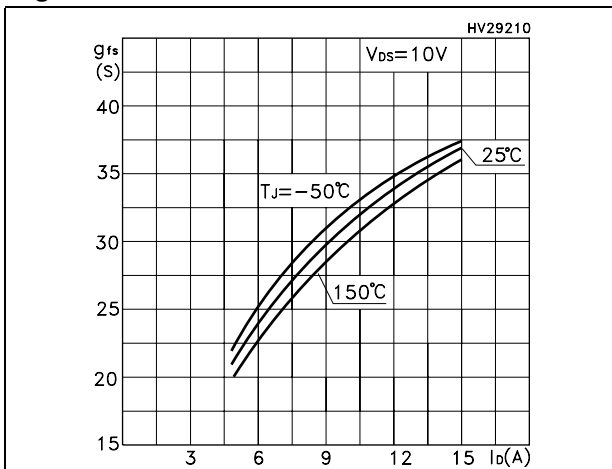

Figure 7. Static drain-source on resistance

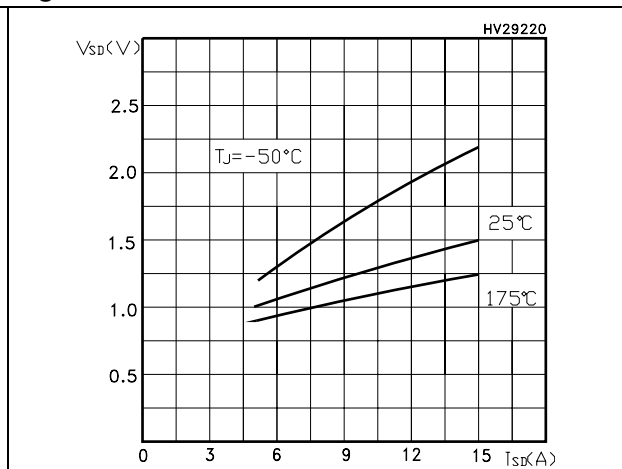

Figure 8. Gate charge vs gate-source voltage Figure 9. Capacitance variations

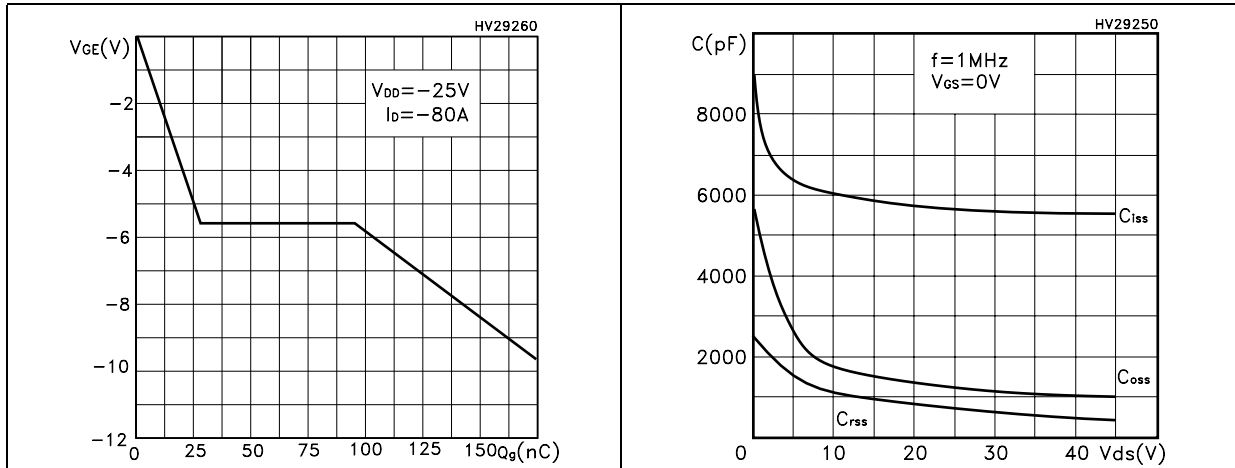

Figure 10. Normalized gate threshold voltage vs temperature Figure 11. Normalized on resistance vs temperature

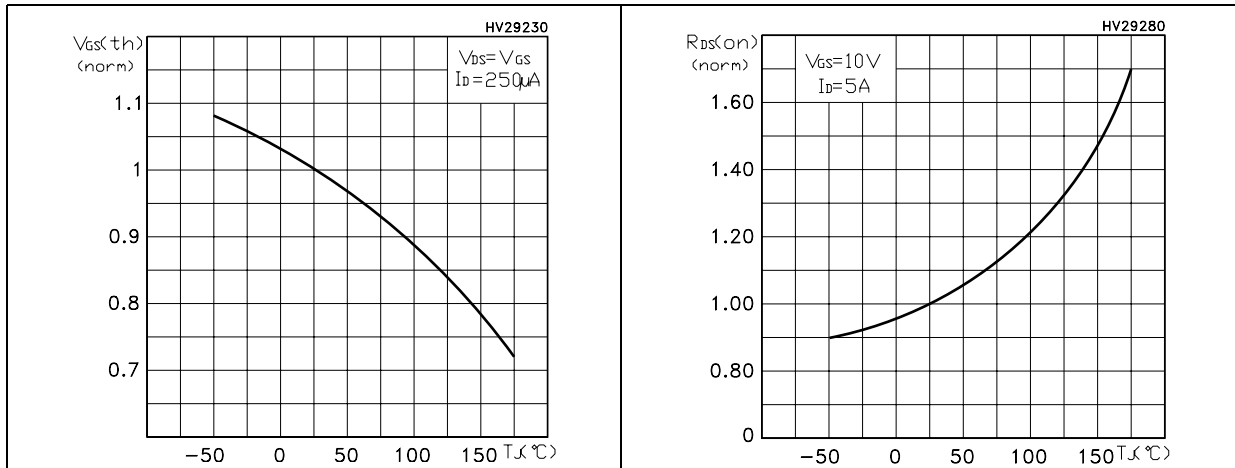
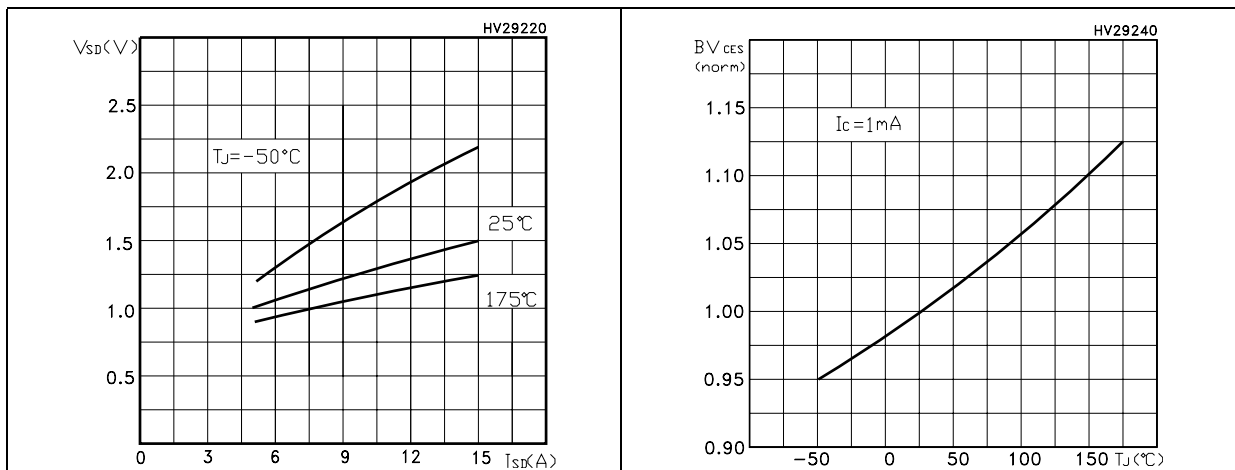

Figure 12. Source-drain diode forward characteristics Figure 13. Normalized BV_{DSS} vs temperature



3 Test circuits

Figure 14. Switching times test circuit for resistive load

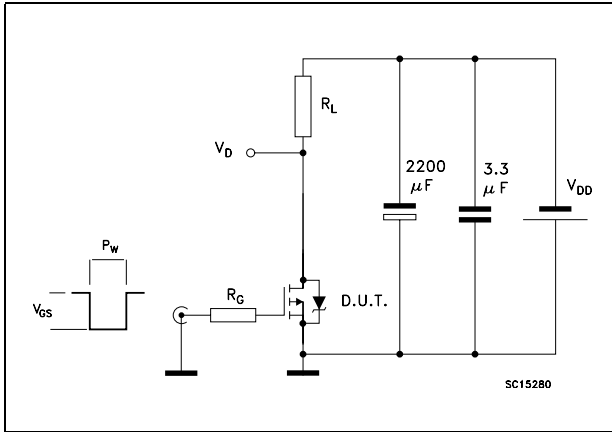

Figure 15. Gate charge test circuit

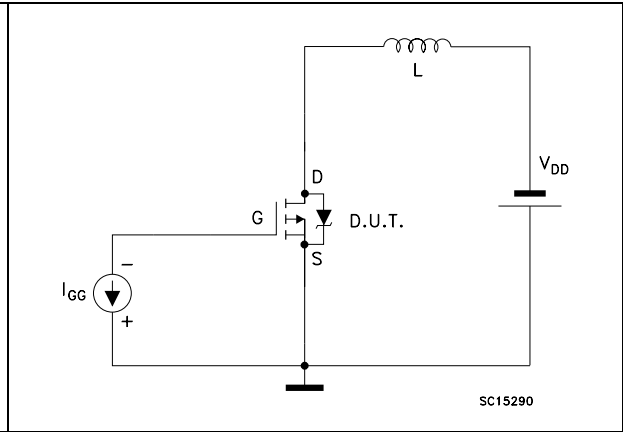
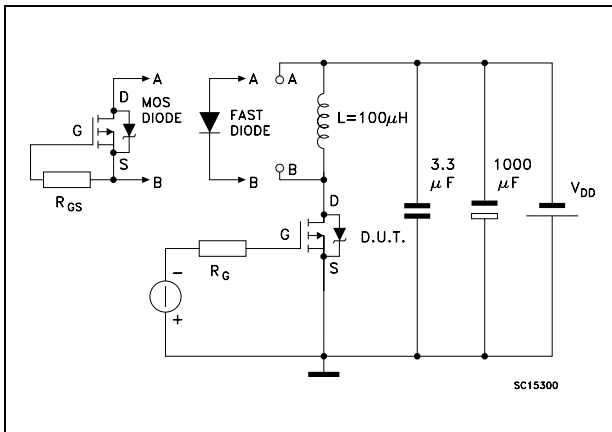

Figure 16. Test circuit for inductive load switching and diode recovery times



4 Package mechanical data

In order to meet environmental requirements, ST offers these devices in different grades of ECOPACK® packages, depending on their level of environmental compliance. ECOPACK® specifications, grade definitions and product status are available at: www.st.com. ECOPACK is an ST trademark.

Table 8. D²PAK mechanical data

Dim	mm			inch		
	Min.	Typ.	Max.	Min.	Typ.	Max.
A	4.40		4.60	0.173		0.181
A1	0.03		0.23	0.001		0.009
b	0.70		0.93	0.027		0.037
b2	1.14		1.70	0.045		0.067
c	0.45		0.60	0.017		0.024
c2	1.23		1.36	0.048		0.053
D	8.95		9.35	0.352		0.368
D1	7.50			0.295		
E	10		10.40	0.394		0.409
E1	8.50			0.334		
e		2.54			0.1	
e1	4.88		5.28	0.192		0.208
H	15		15.85	0.590		0.624
J1	2.49		2.69	0.099		0.106
L	2.29		2.79	0.090		0.110
L1	1.27		1.40	0.05		0.055
L2	1.30		1.75	0.051		0.069
R		0.4			0.016	
V2	0°		8°	0°		8°

Figure 17. D²PAK drawing

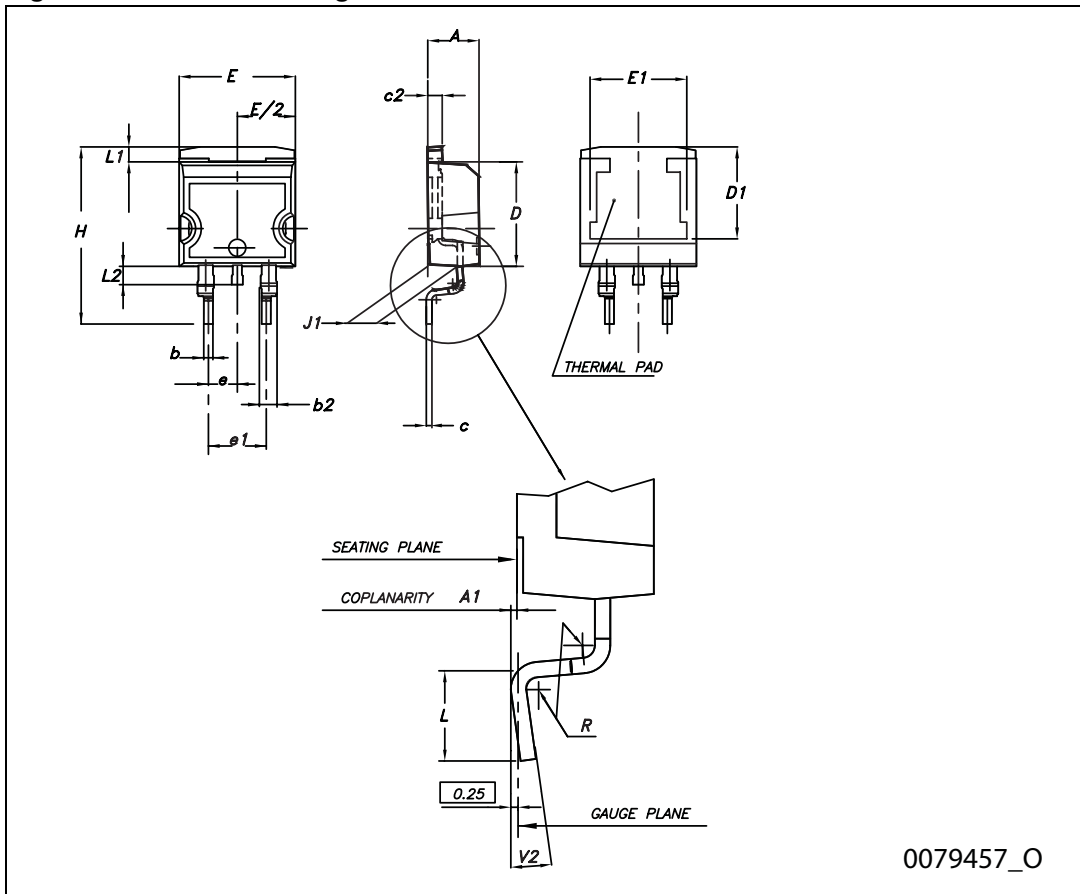

0079457_O

Table 9. TO-220 mechanical data

Dim	mm		
	Min.	Typ.	Max.
A	4.40		4.60
b	0.61		0.88
b1	1.14		1.70
c	0.48		0.70
D	15.25		15.75
D1		1.27	
E	10		10.40
e	2.40		2.70
e1	4.95		5.15
F	1.23		1.32
H1	6.20		6.60
J1	2.40		2.72
L	13		14
L1	3.50		3.93
L20		16.40	
L30		28.90	
ØP	3.75		3.85
Q	2.65		2.95

Figure 18. TO-220 drawing

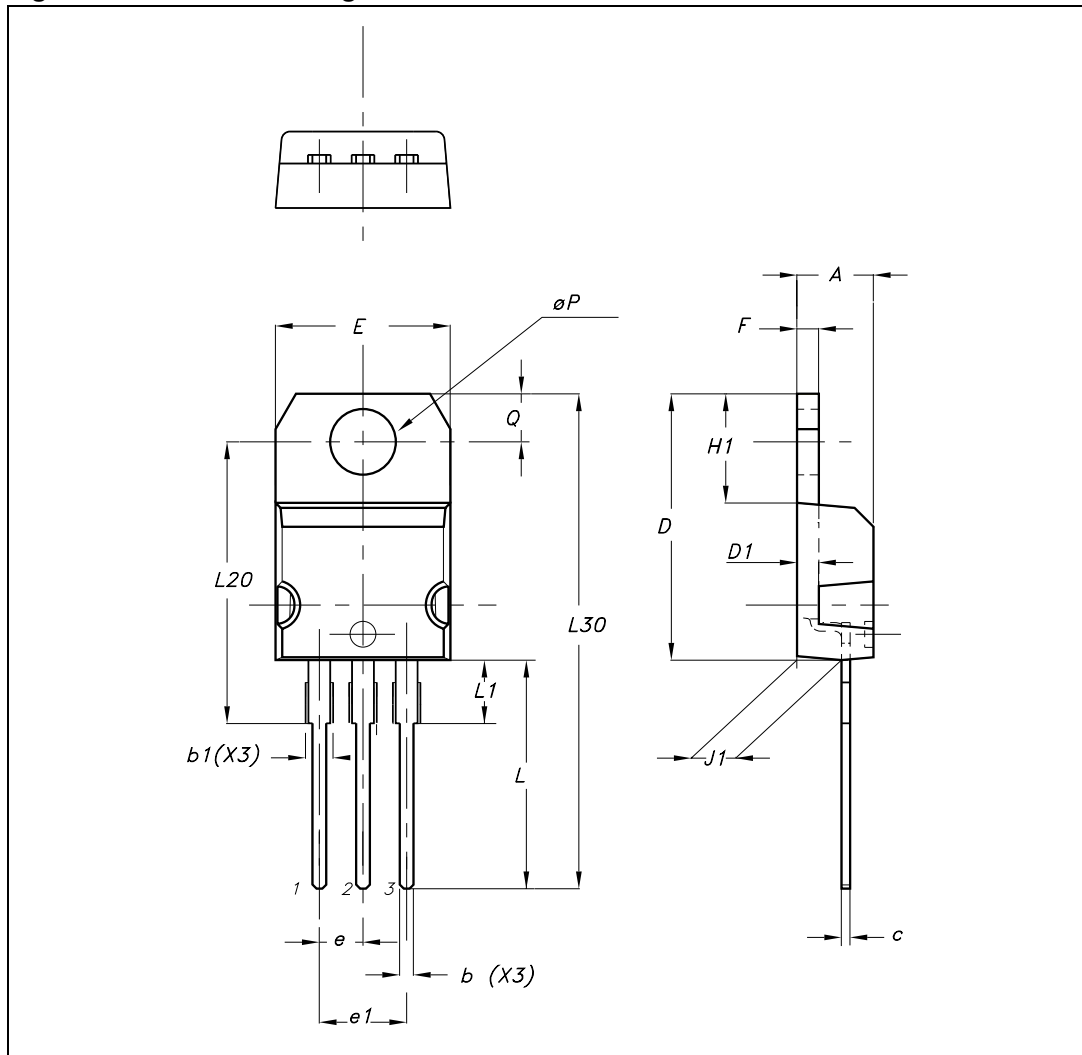

5 Packaging mechanical data

D²PAK FOOTPRINT

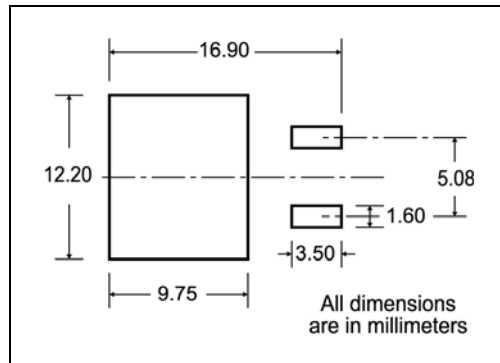

TAPE AND REEL SHIPMENT

40 mm min. Access hole at slot location

Full radius

Tape slot in core for tape start

2.5mm min. width

TAPE MECHANICAL DATA

DIM.	mm		inch	
	MIN.	MAX.	MIN.	MAX.
A0	10.5	10.7	0.413	0.421
B0	15.7	15.9	0.618	0.626
D	1.5	1.6	0.059	0.063
D1	1.59	1.61	0.062	0.063
E	1.65	1.85	0.065	0.073
F	11.4	11.6	0.449	0.456
K0	4.8	5.0	0.189	0.197
P0	3.9	4.1	0.153	0.161
P1	11.9	12.1	0.468	0.476
P2	1.9	2.1	0.075	0.082
R	50		1.574	
T	0.25	0.35	0.0098	0.0137
W	23.7	24.3	0.933	0.956

REEL MECHANICAL DATA

DIM.	mm		inch	
	MIN.	MAX.	MIN.	MAX.
A		330		12.992
B	1.5		0.059	
C	12.8	13.2	0.504	0.520
D	20.2		0.795	
G	24.4	26.4	0.960	1.039
N	100		3.937	
T		30.4		1.197

BASE QTY	BULK QTY
1000	1000

10 pitches cumulative tolerance on tape +/- 0.2 mm

Center line of cavity

User Direction of Feed

FEED DIRECTION

Bending radius R min.

* on sales type

6 Revision history

Table 10. Document revision history

Date	Revision	Changes
09-Sep-2004	4	Revalidation
12-Sep-2006	5	New template, D ² PAK added
09-Aug-2010	6	Content reworked to improve readability, no technical changes.

Please Read Carefully:

Information in this document is provided solely in connection with ST products. STMicroelectronics NV and its subsidiaries ("ST") reserve the right to make changes, corrections, modifications or improvements, to this document, and the products and services described herein at any time, without notice.

All ST products are sold pursuant to ST's terms and conditions of sale.

Purchasers are solely responsible for the choice, selection and use of the ST products and services described herein, and ST assumes no liability whatsoever relating to the choice, selection or use of the ST products and services described herein.

No license, express or implied, by estoppel or otherwise, to any intellectual property rights is granted under this document. If any part of this document refers to any third party products or services it shall not be deemed a license grant by ST for the use of such third party products or services, or any intellectual property contained therein or considered as a warranty covering the use in any manner whatsoever of such third party products or services or any intellectual property contained therein.

UNLESS OTHERWISE SET FORTH IN ST'S TERMS AND CONDITIONS OF SALE ST DISCLAIMS ANY EXPRESS OR IMPLIED WARRANTY WITH RESPECT TO THE USE AND/OR SALE OF ST PRODUCTS INCLUDING WITHOUT LIMITATION IMPLIED WARRANTIES OF MERCHANTABILITY, FITNESS FOR A PARTICULAR PURPOSE (AND THEIR EQUIVALENTS UNDER THE LAWS OF ANY JURISDICTION), OR INFRINGEMENT OF ANY PATENT, COPYRIGHT OR OTHER INTELLECTUAL PROPERTY RIGHT.

UNLESS EXPRESSLY APPROVED IN WRITING BY AN AUTHORIZED ST REPRESENTATIVE, ST PRODUCTS ARE NOT RECOMMENDED, AUTHORIZED OR WARRANTED FOR USE IN MILITARY, AIR CRAFT, SPACE, LIFE SAVING, OR LIFE SUSTAINING APPLICATIONS, NOR IN PRODUCTS OR SYSTEMS WHERE FAILURE OR MALFUNCTION MAY RESULT IN PERSONAL INJURY, DEATH, OR SEVERE PROPERTY OR ENVIRONMENTAL DAMAGE. ST PRODUCTS WHICH ARE NOT SPECIFIED AS "AUTOMOTIVE GRADE" MAY ONLY BE USED IN AUTOMOTIVE APPLICATIONS AT USER'S OWN RISK.

Resale of ST products with provisions different from the statements and/or technical features set forth in this document shall immediately void any warranty granted by ST for the ST product or service described herein and shall not create or extend in any manner whatsoever, any liability of ST.

ST and the ST logo are trademarks or registered trademarks of ST in various countries.

Information in this document supersedes and replaces all information previously supplied.

The ST logo is a registered trademark of STMicroelectronics. All other names are the property of their respective owners.

© 2010 STMicroelectronics - All rights reserved

STMicroelectronics group of companies

Australia - Belgium - Brazil - Canada - China - Czech Republic - Finland - France - Germany - Hong Kong - India - Israel - Italy - Japan - Malaysia - Malta - Morocco - Philippines - Singapore - Spain - Sweden - Switzerland - United Kingdom - United States of America

www.st.com